



ALIENS



Richard Palmer

XB-04001



The author's profile :

Name:Amador & Ramón

Nationality:Spain

Amador & Ramón are the famous building block artwork creator.

He start to touch building block when they were children in the early 80s.

The famous works:Alien Project, Kaneda's Bike, P200 Moto

Alien Project had published on the HispaBrick Magazine cover issue #24 and had made a special interview .

Kaneda's Bike had published in the HispaBrick Magazine issue#18.

Other representative works were published in the Brickjournal magazine issue#2 and issue #11.

Received an interview with TAG TechArtGeek magazine,the interview was published in the same period of the magazine.

Received an interview with BRICKS Culture Issue magazine , the interview was published in the fourth issue of the magazine

The atlas of the Alien Project and Kaneda's Bike are sold well all over the world.



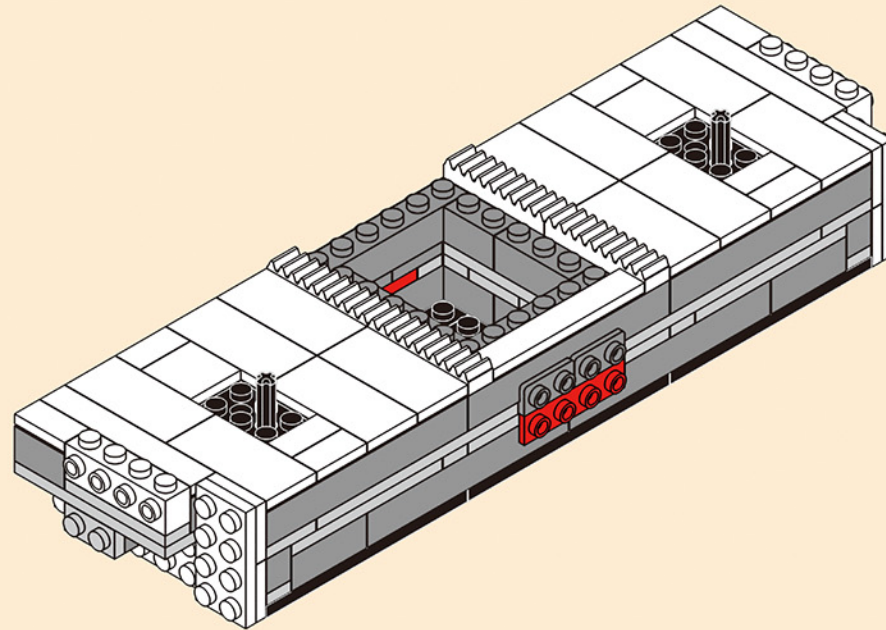

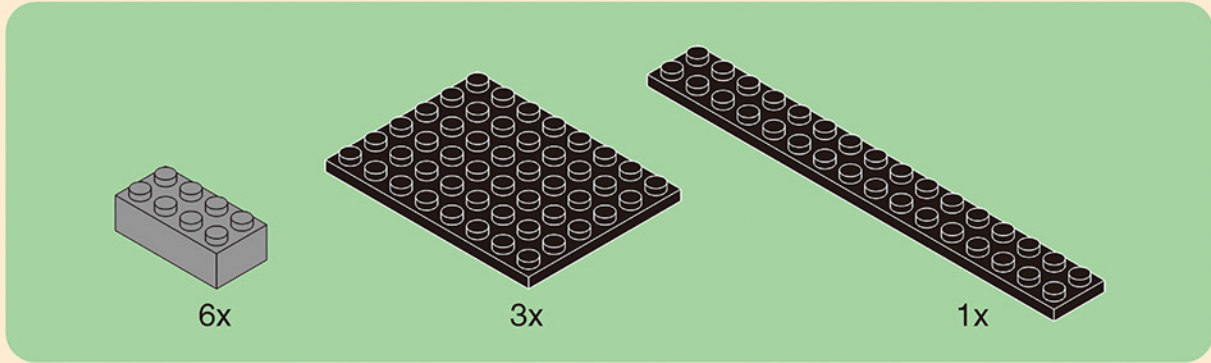

1-1

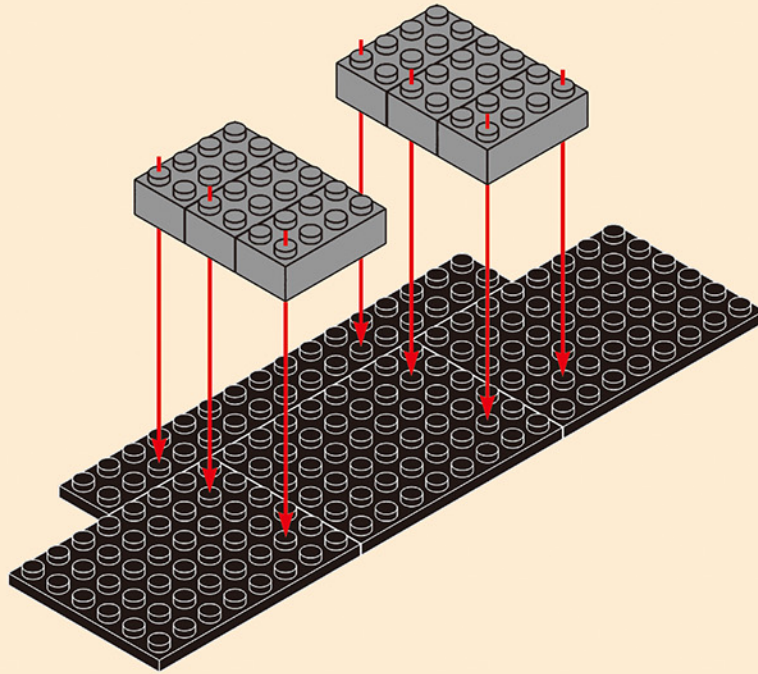

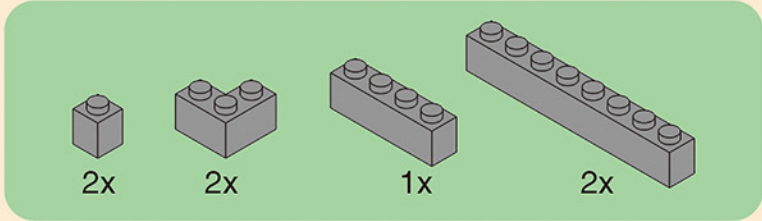

1-2

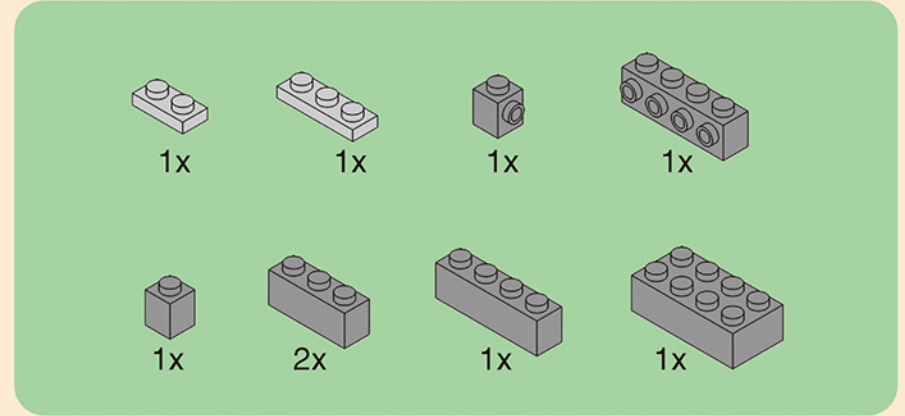
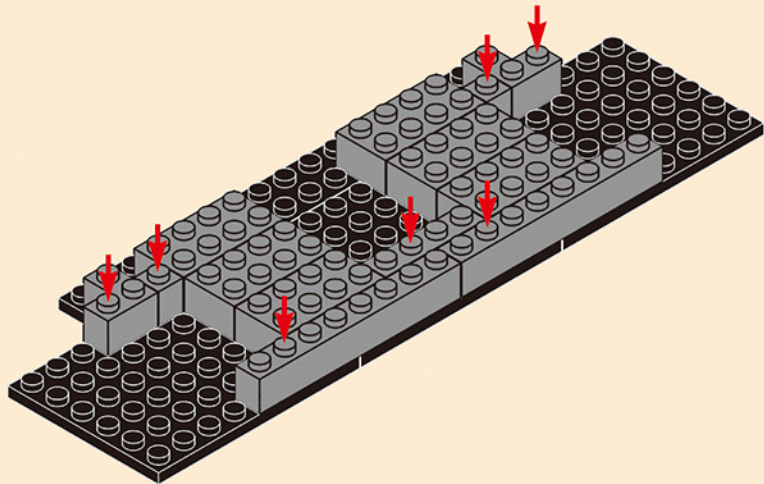

1-3

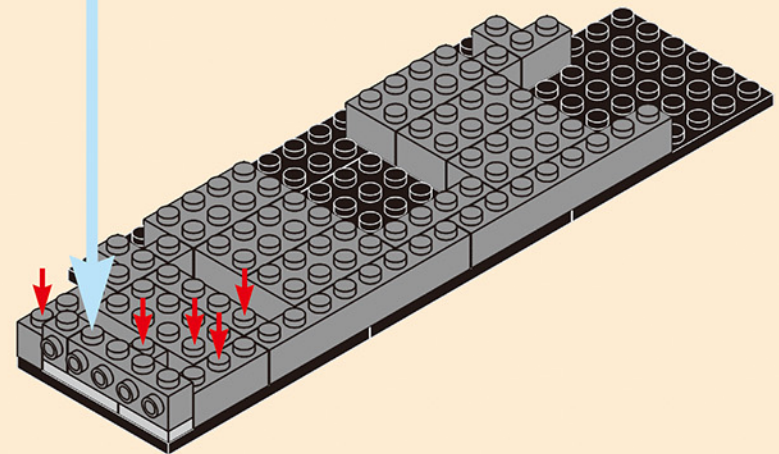
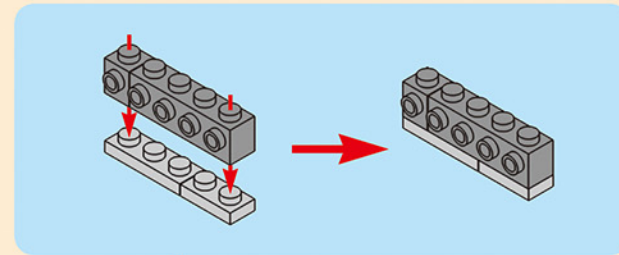

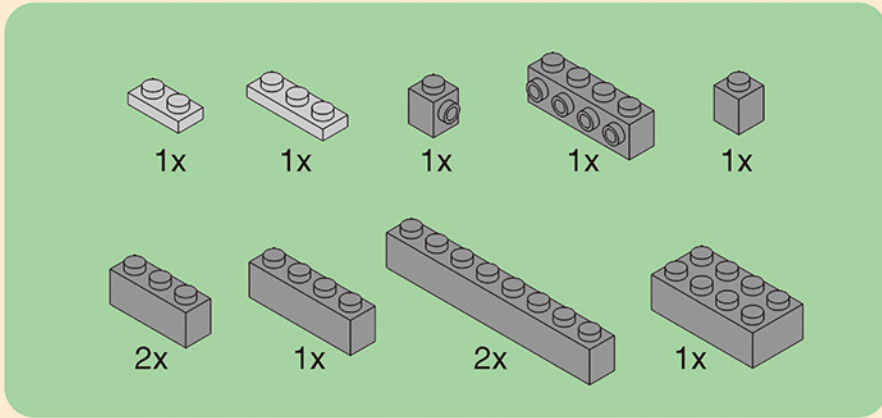

1-4

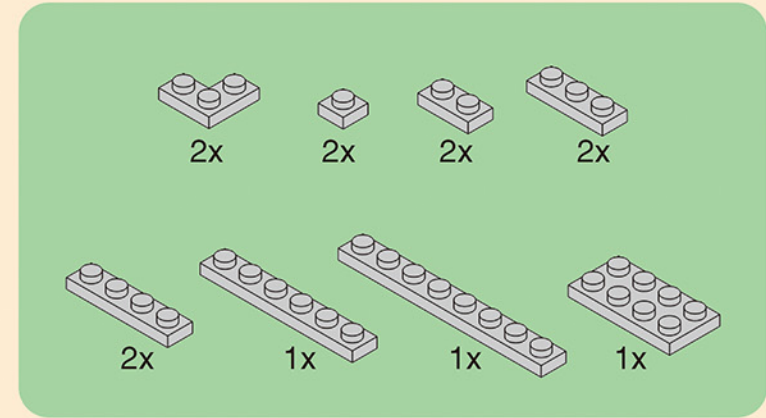

1-5

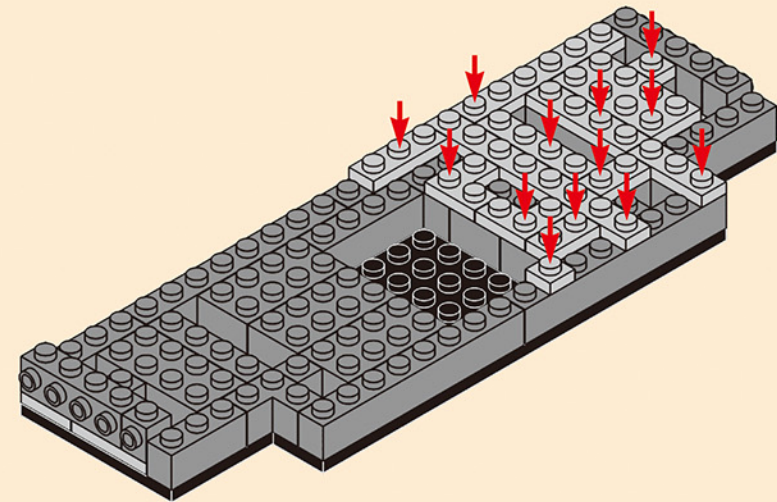
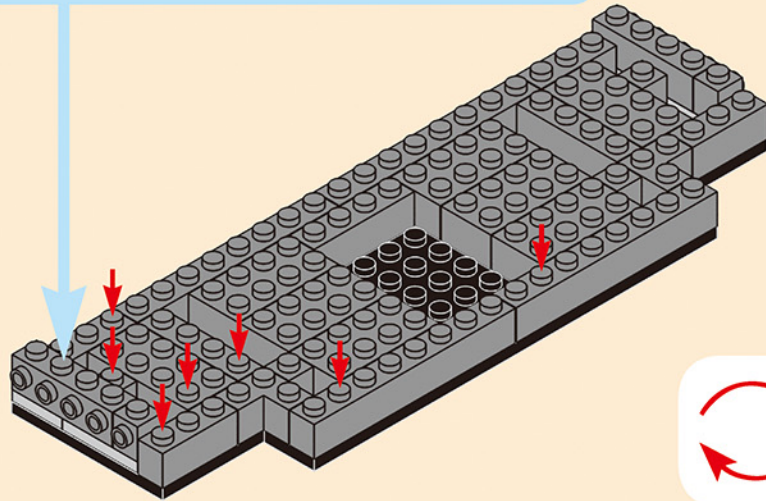
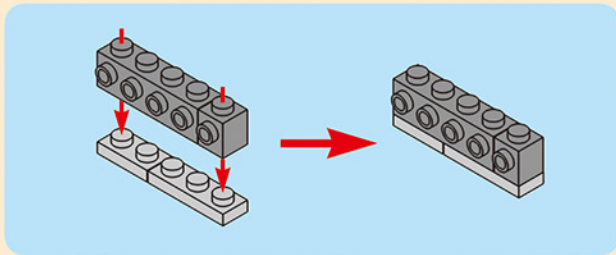

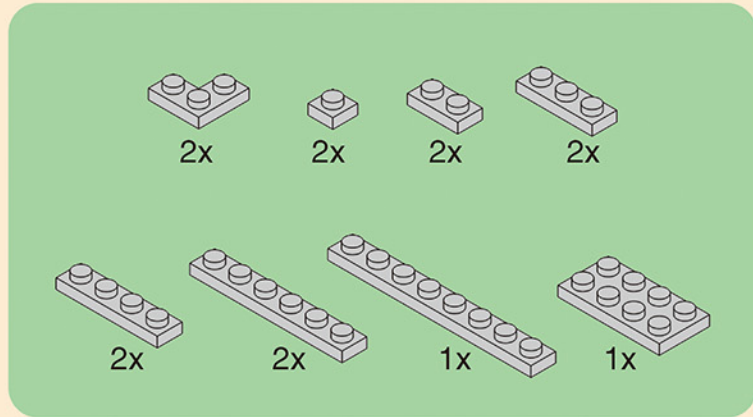

1-6

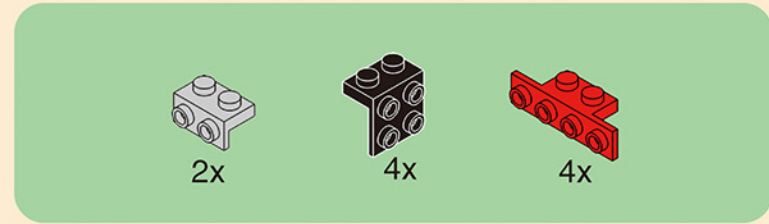
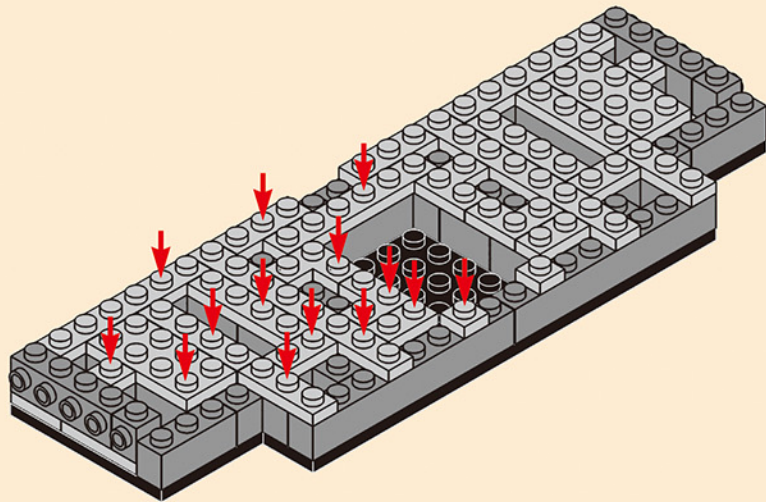

1-7

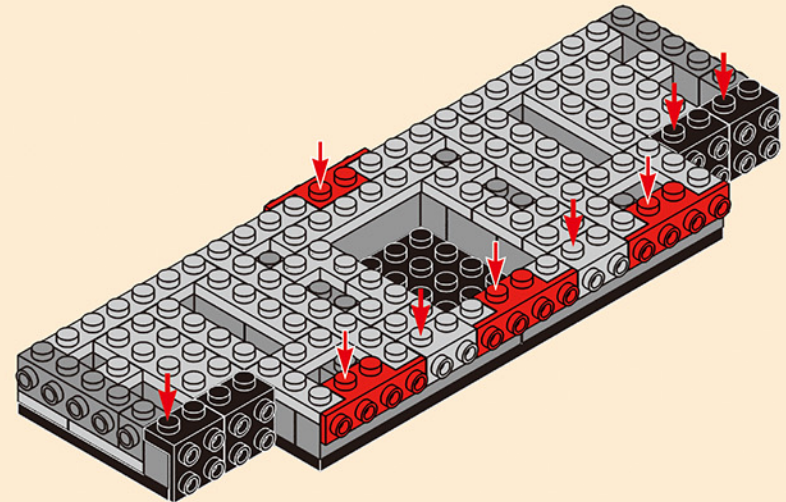

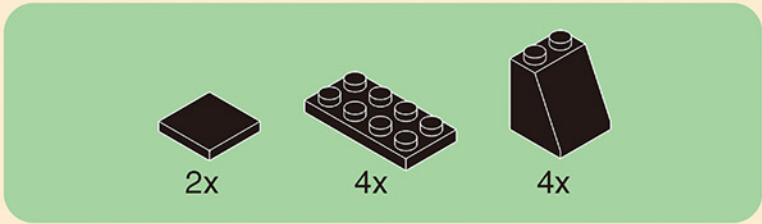

1-8

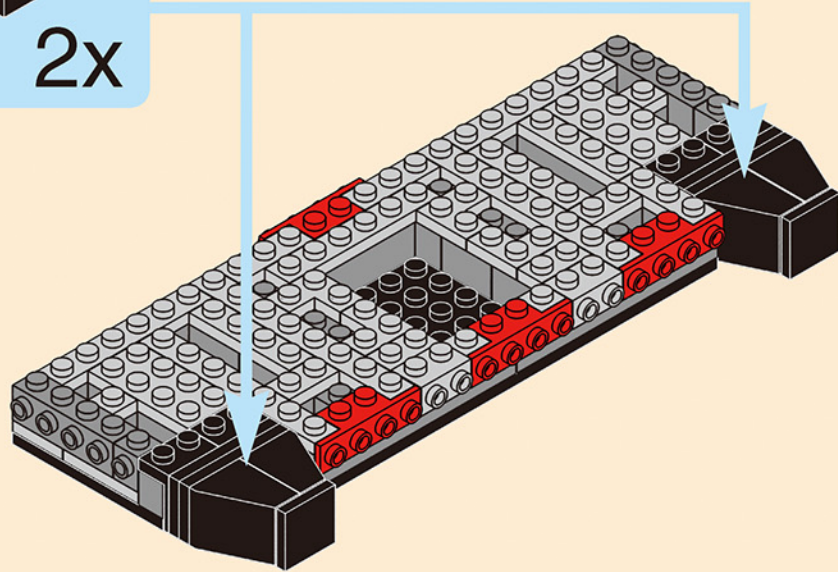
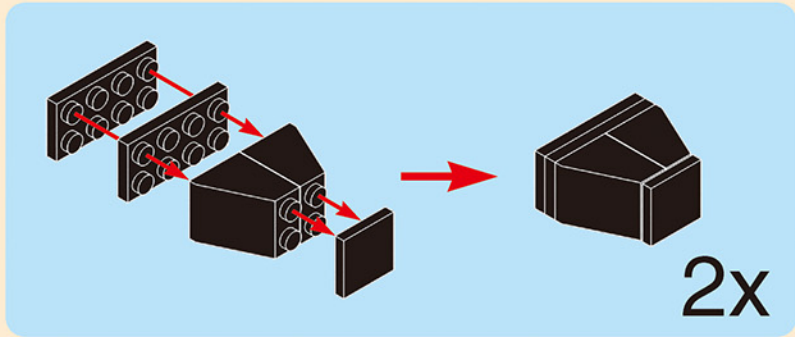

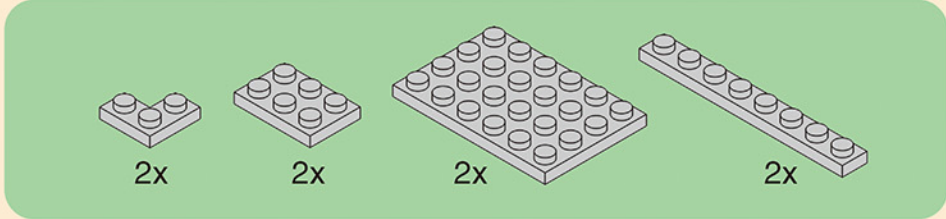

1-9

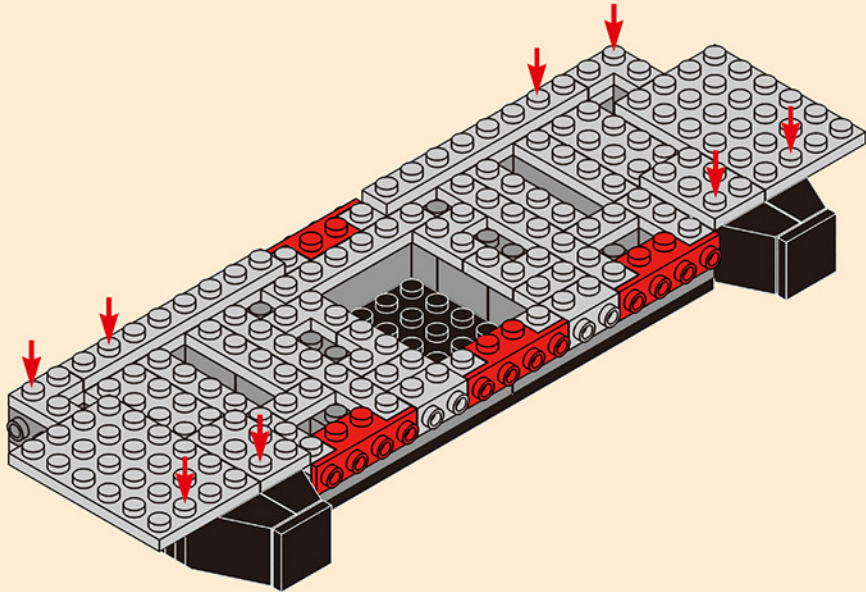

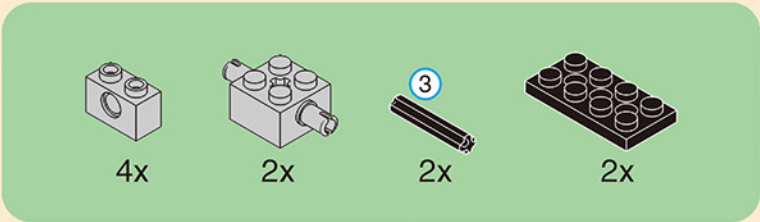

1-10

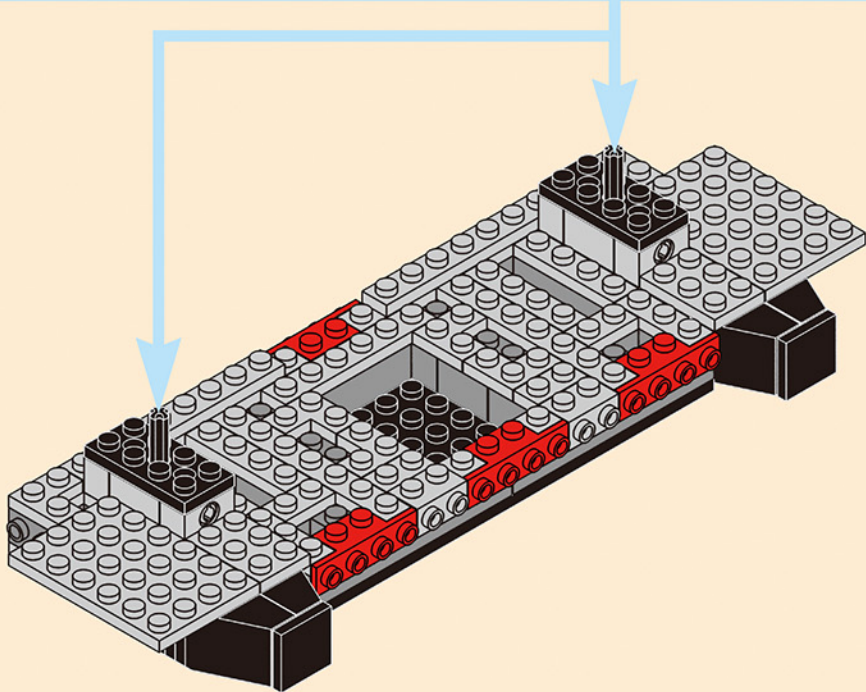
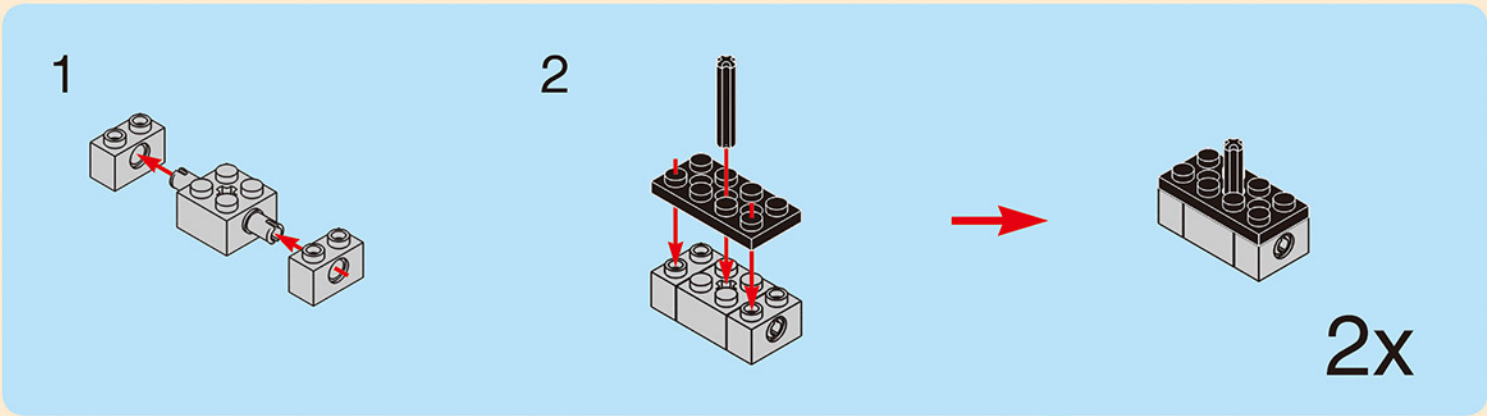

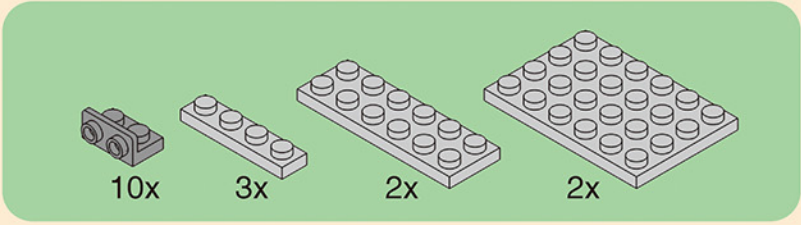

1-11

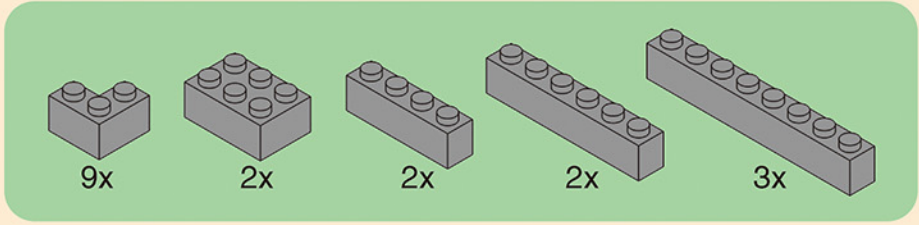
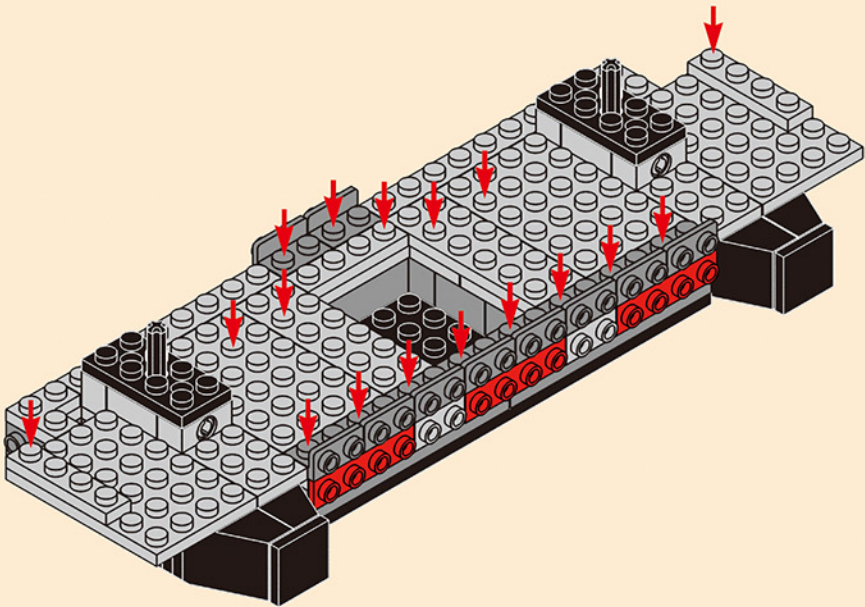

1-12

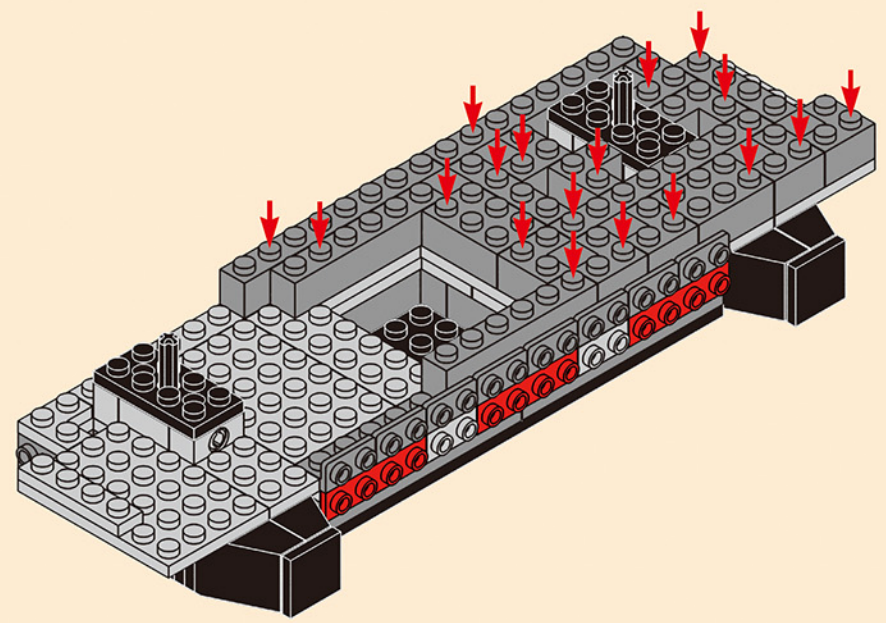

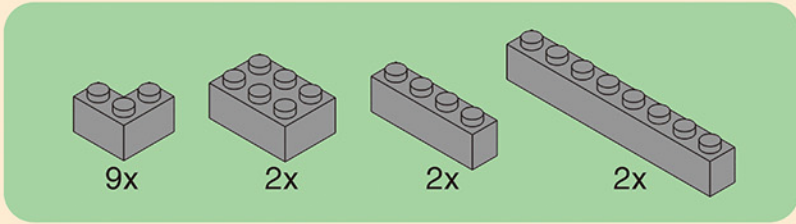

1-13

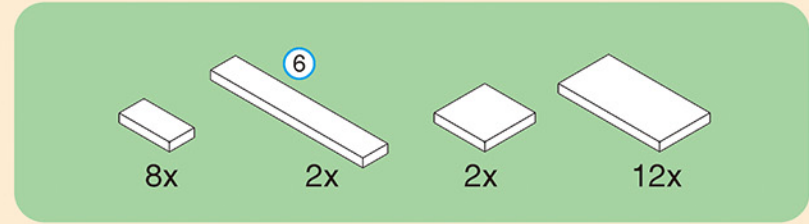
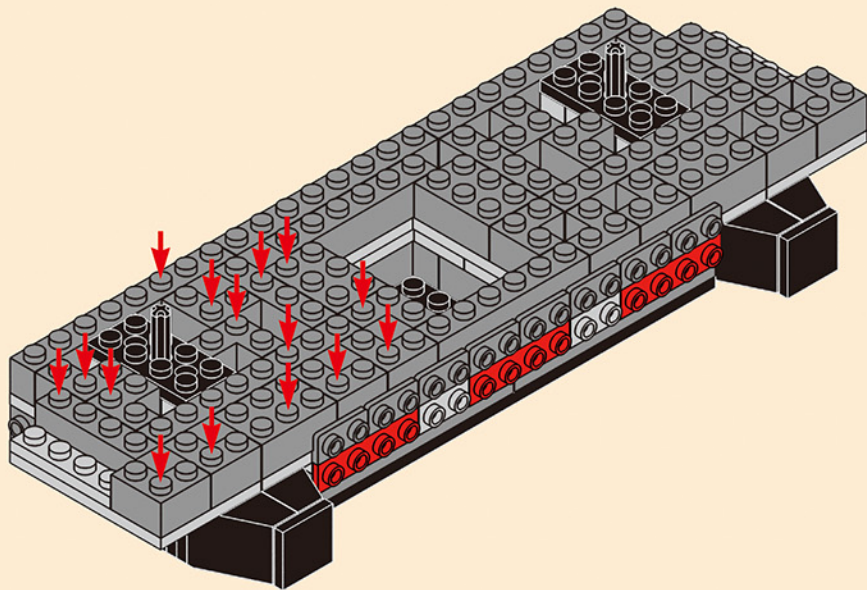

1-14

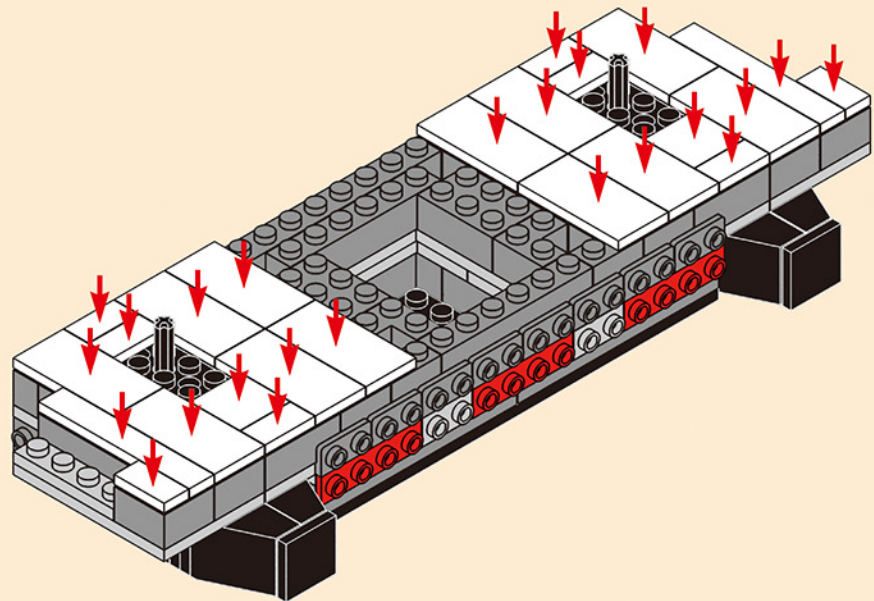

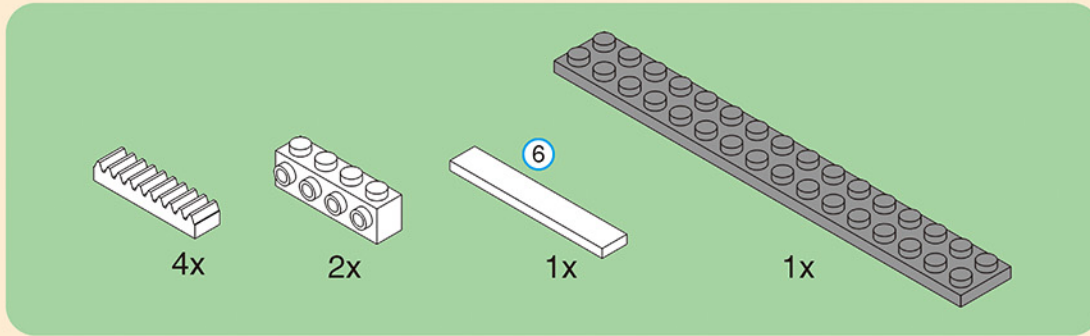

1-15

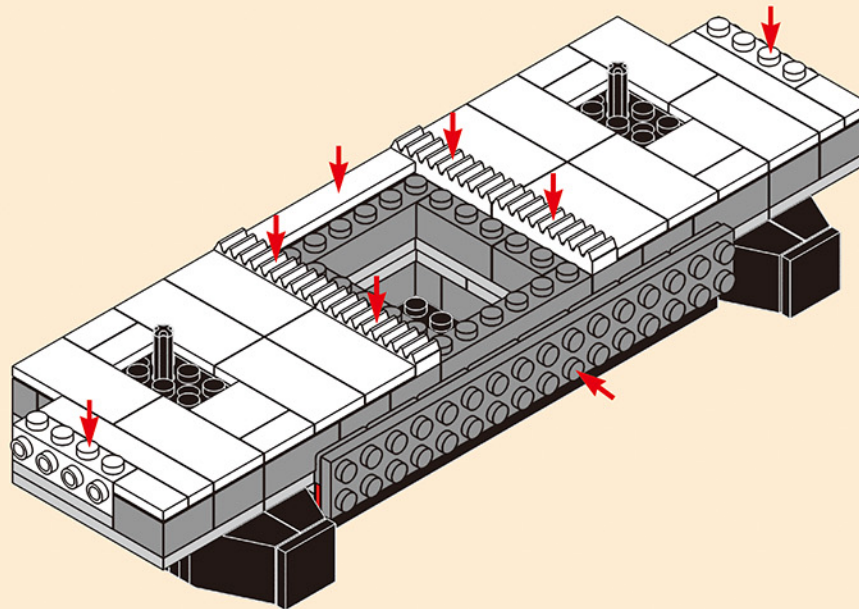

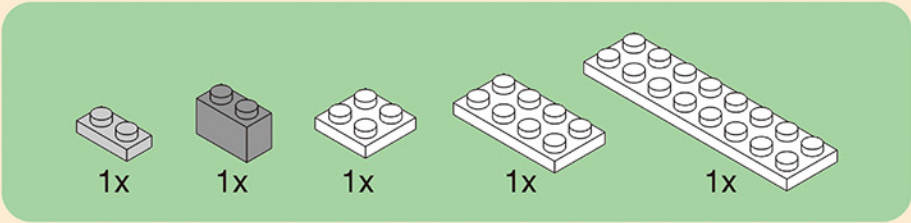

1-16

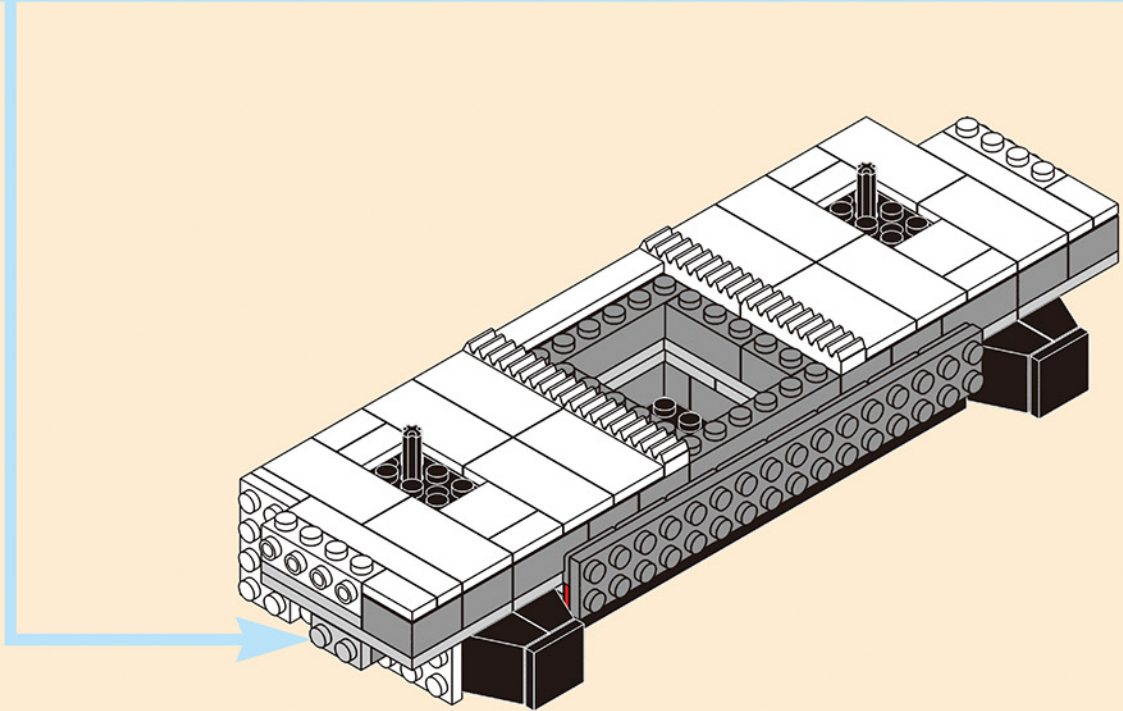
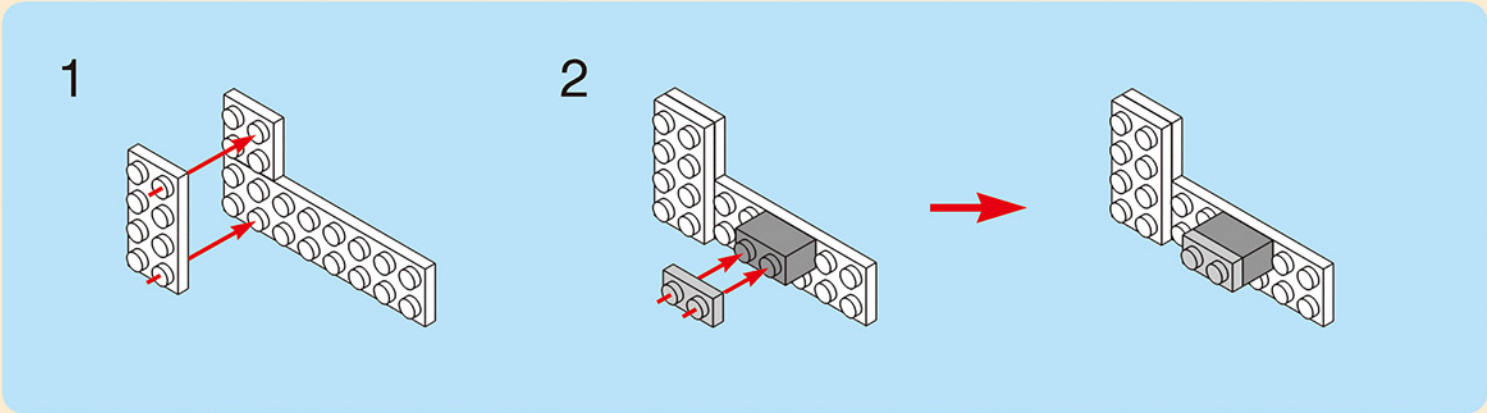

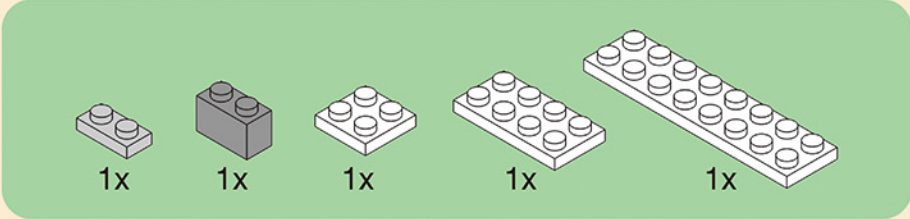

1-17

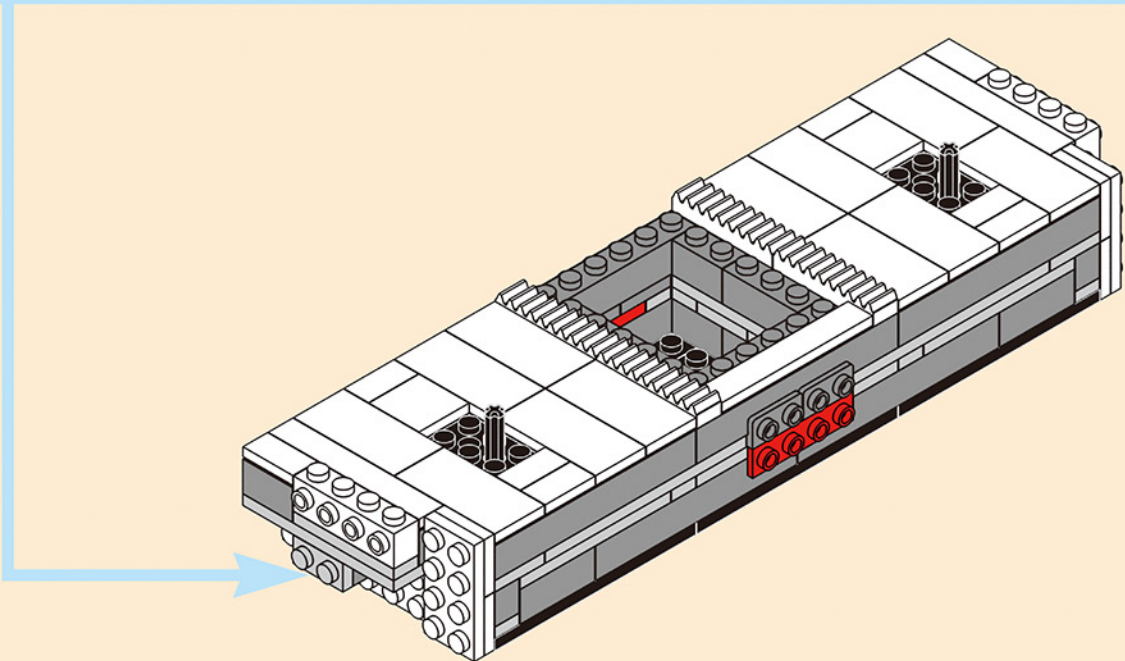
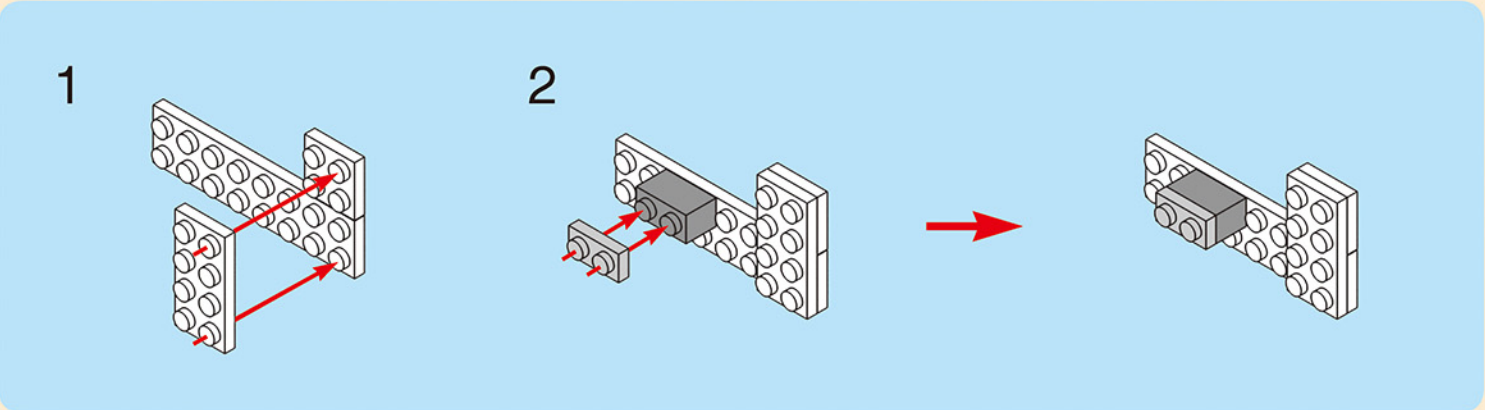

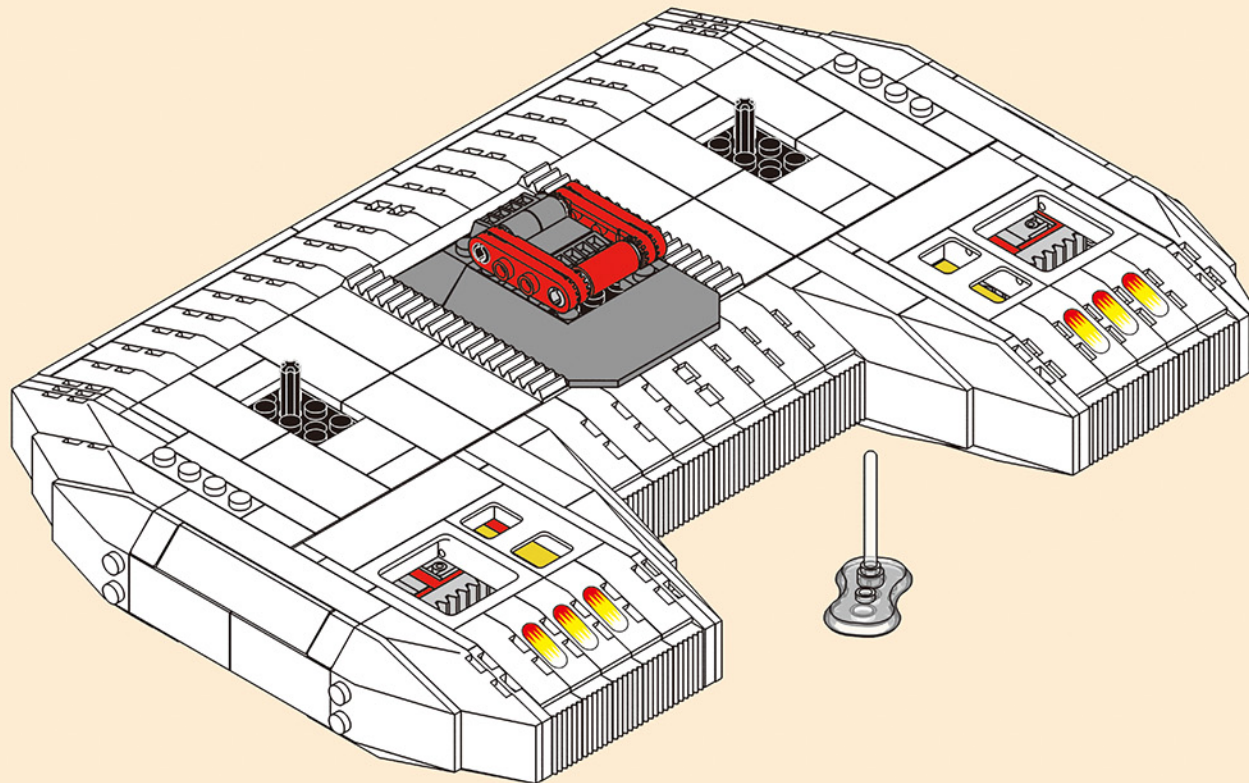

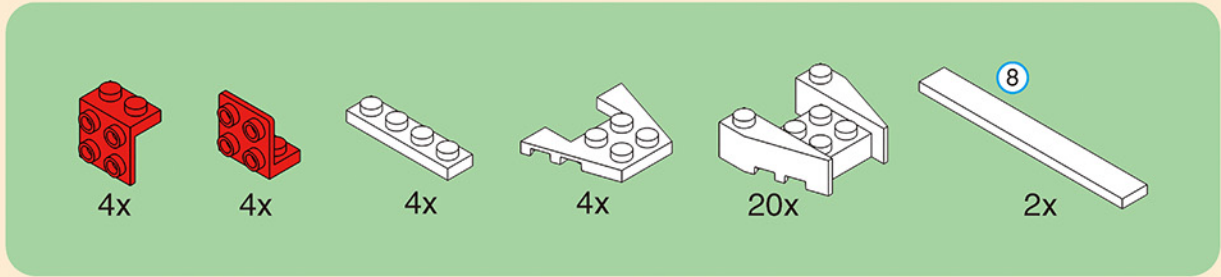

2-1.1

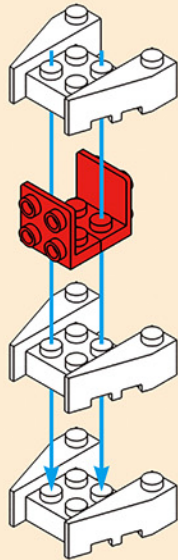

2-1.2

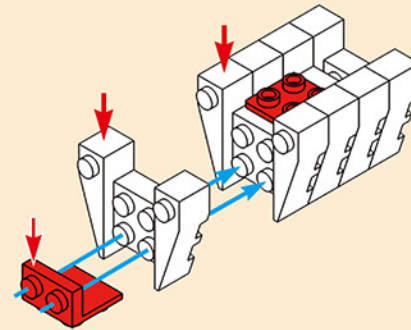

2-1.3

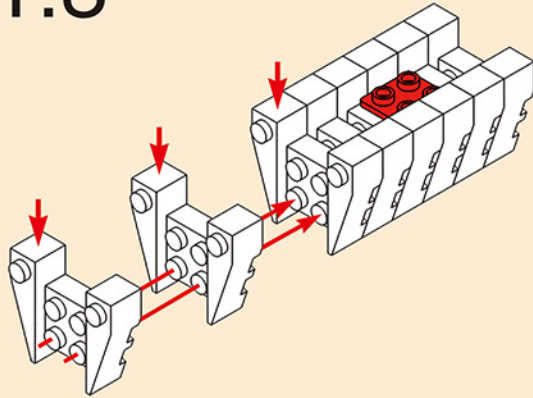

2-1.4

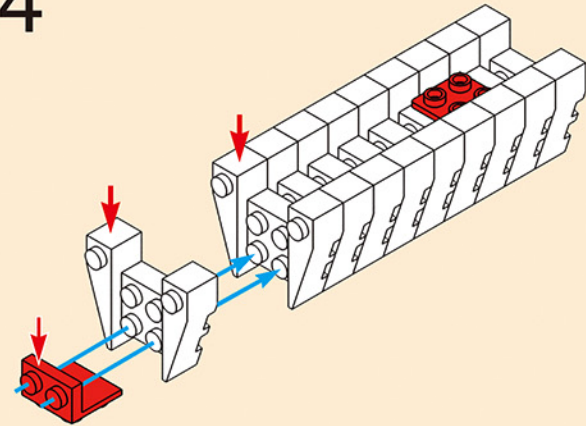

2-1.5

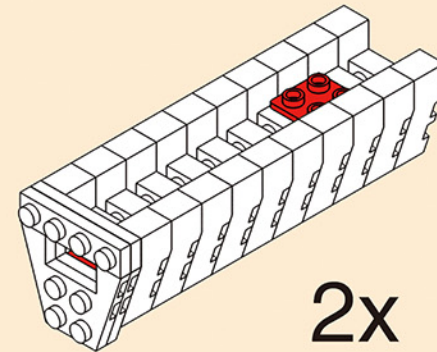
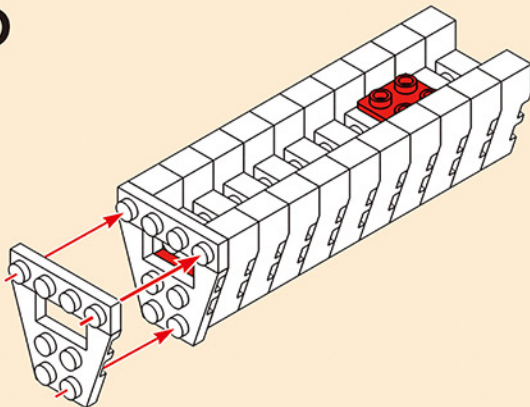

2x

2-1

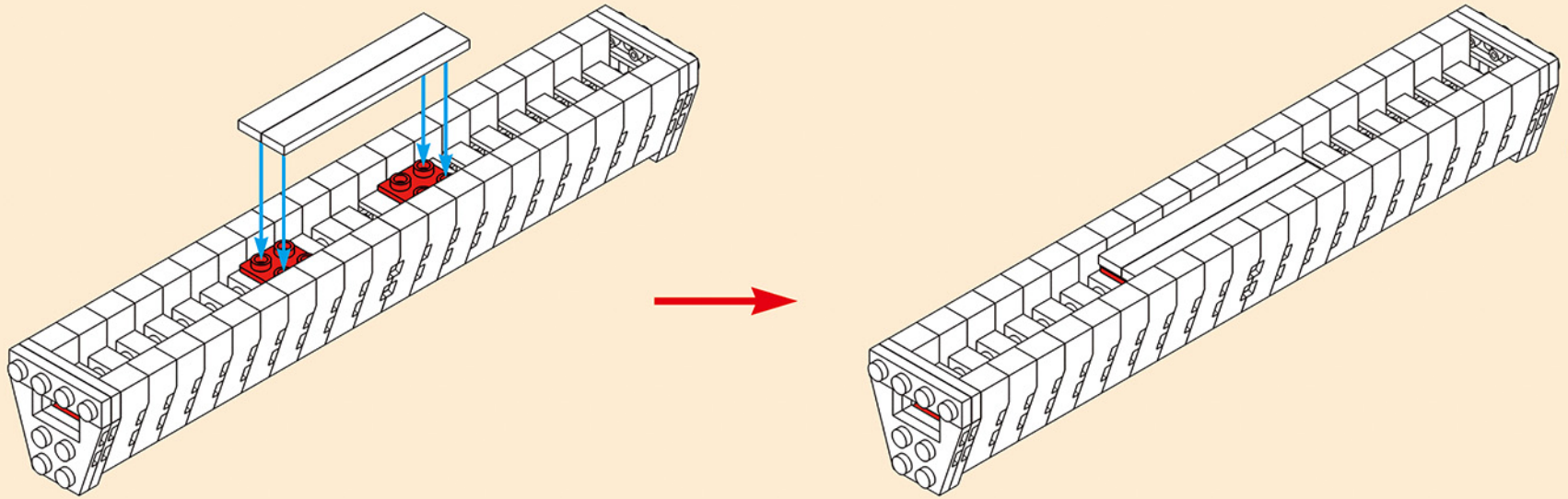

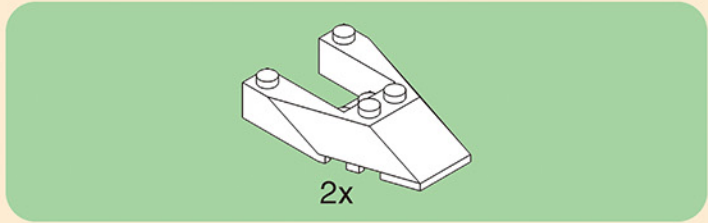

2-2

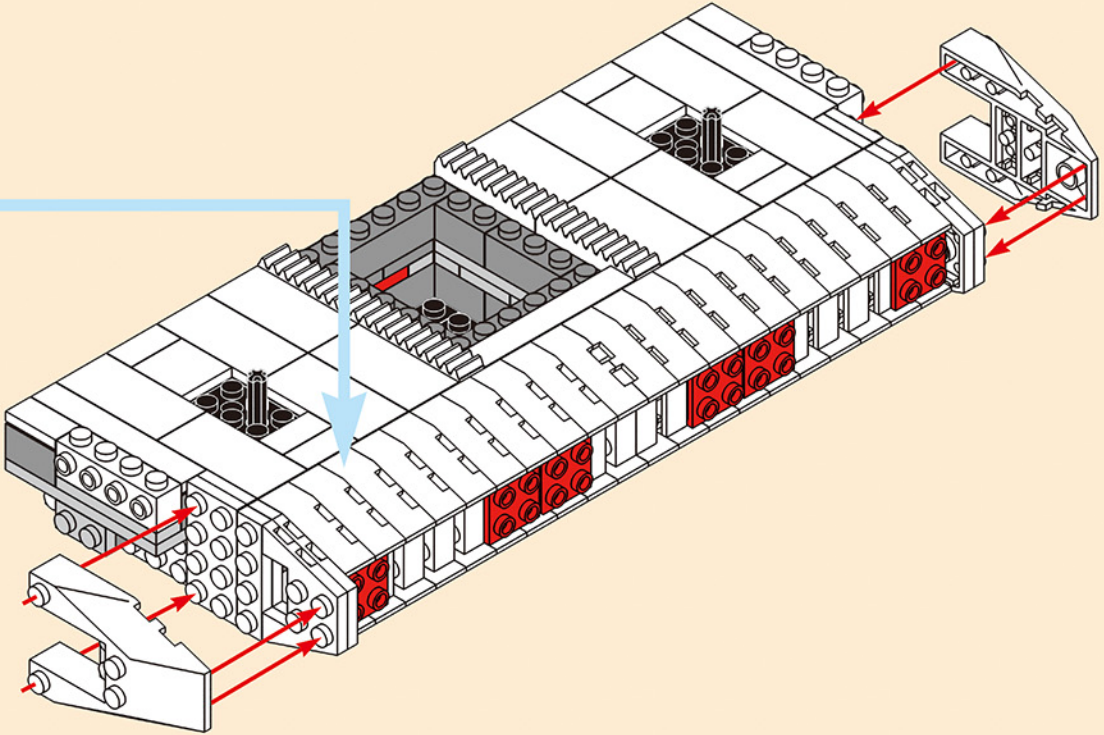

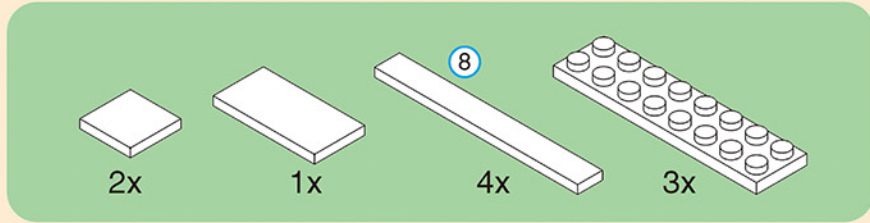

2-3

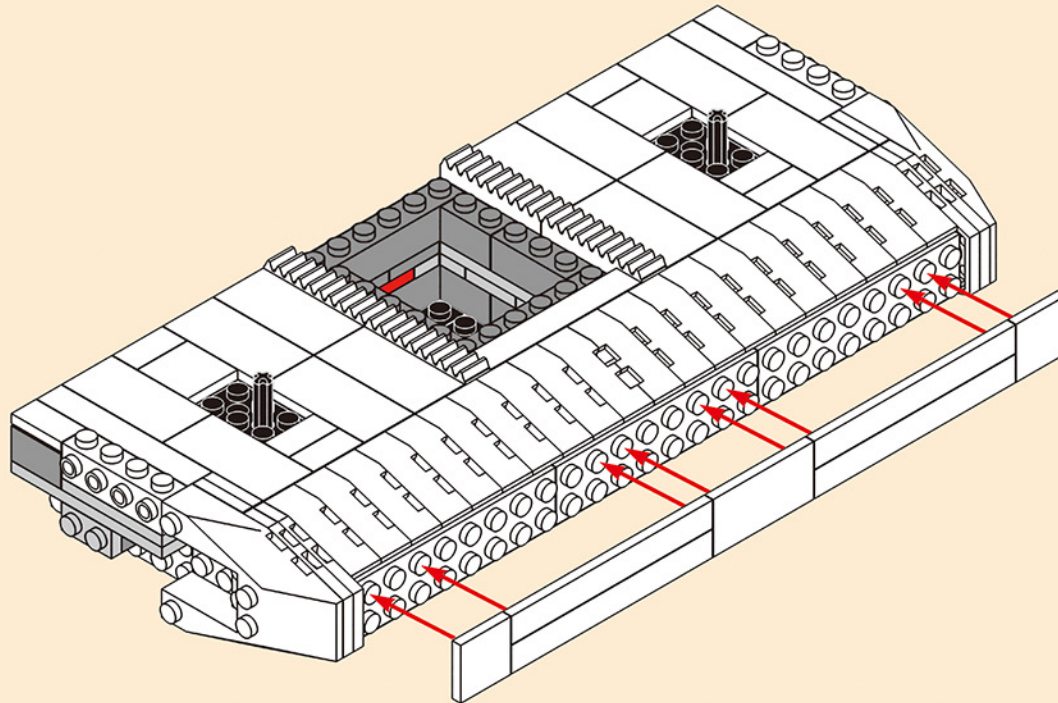

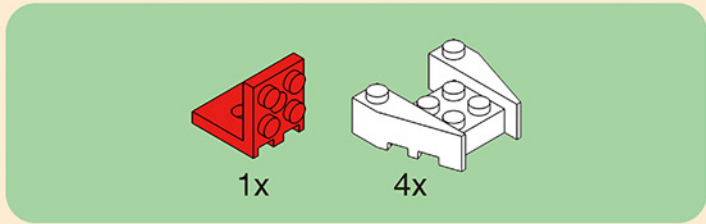

2-4.1

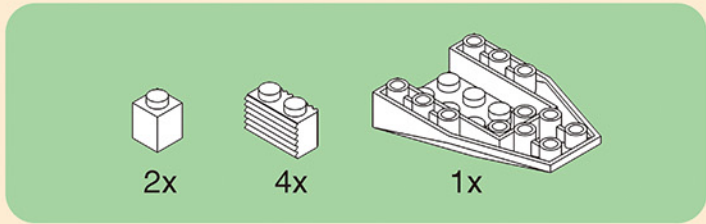
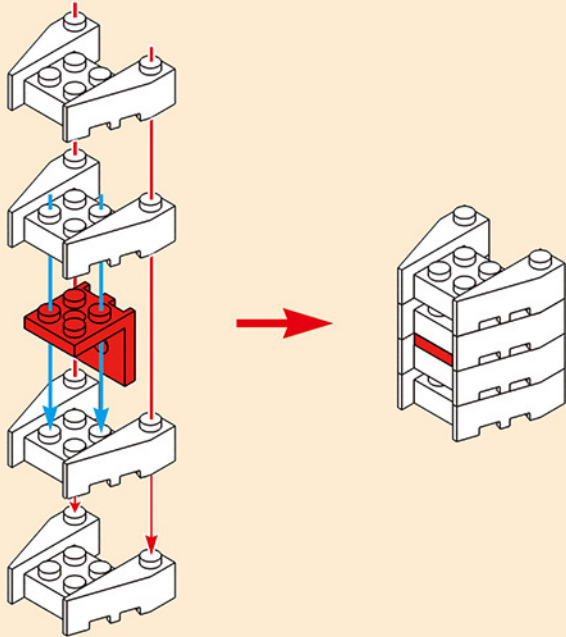

2-4.2

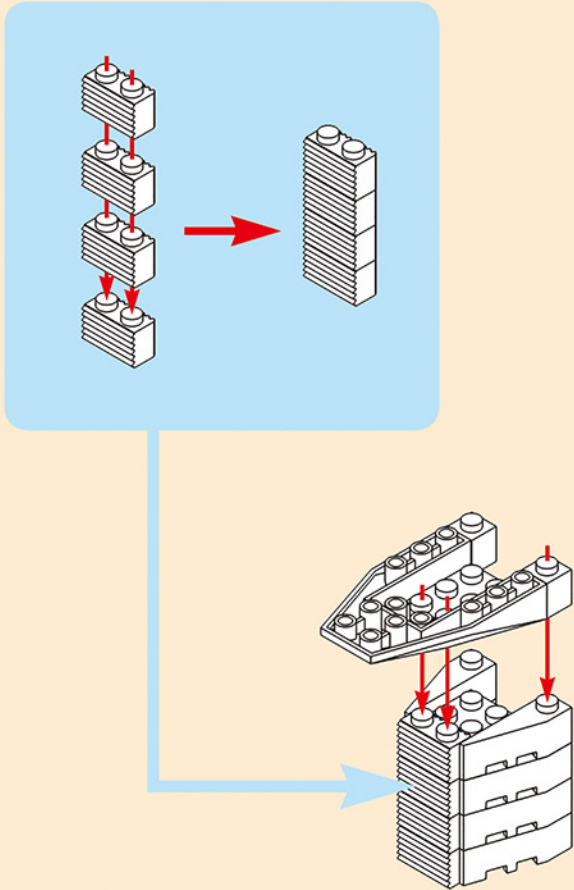

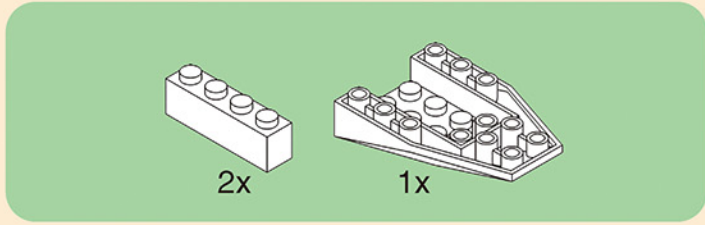

2-4.3

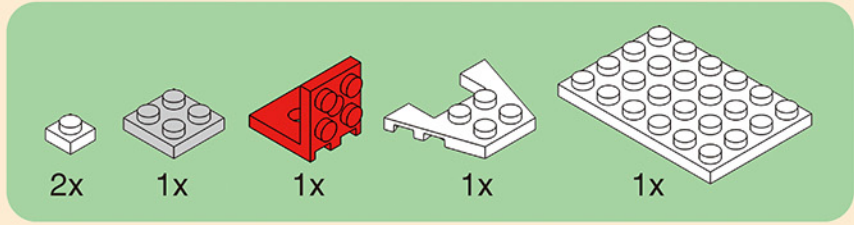
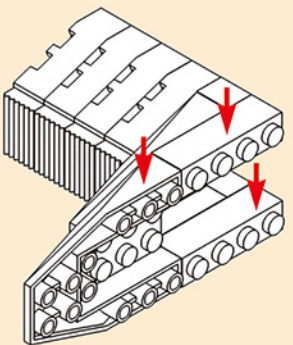

2-4.4

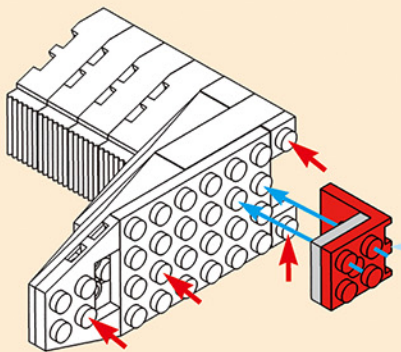
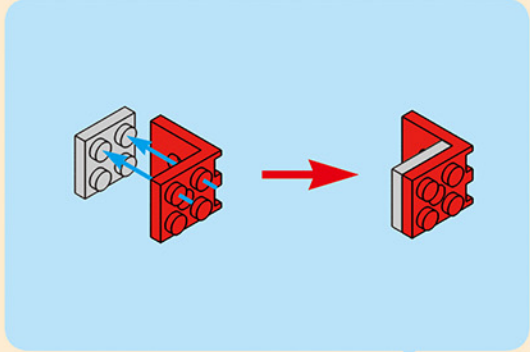

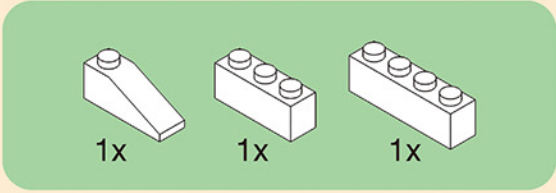

2-4.5

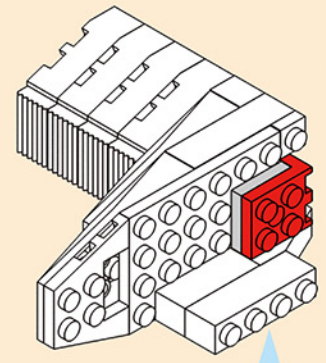
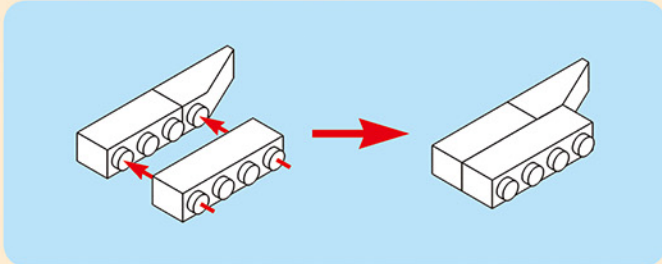

2-4

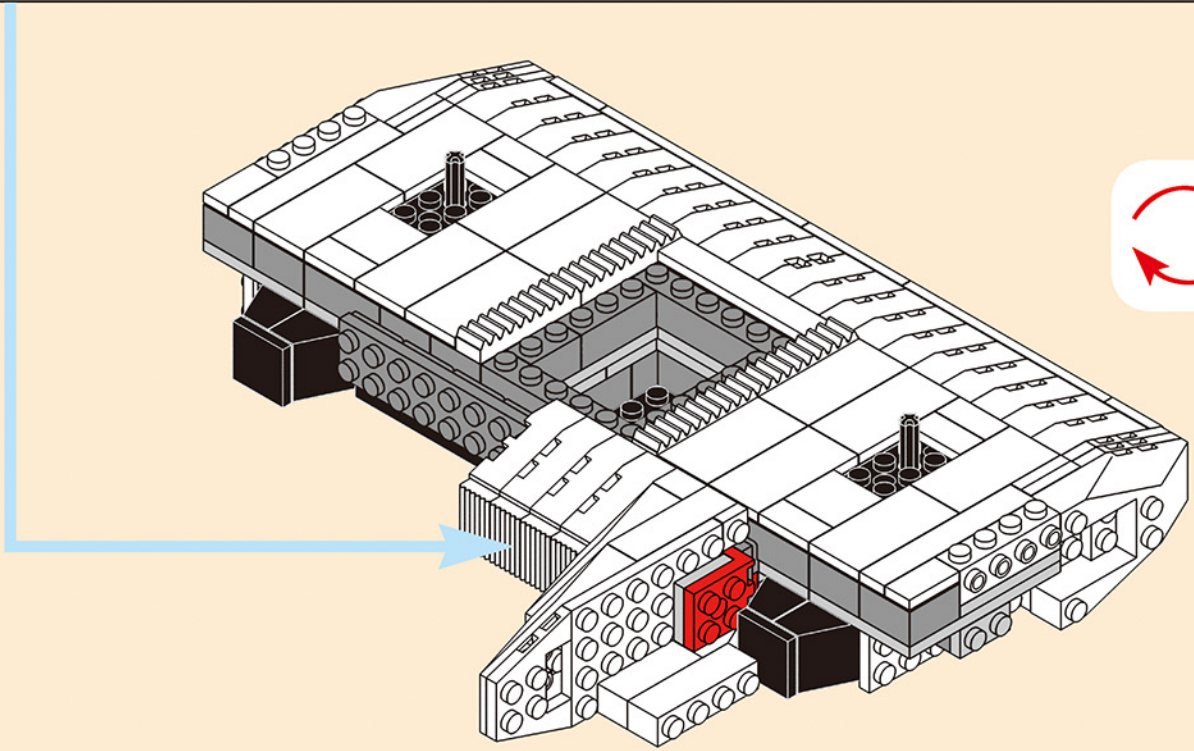

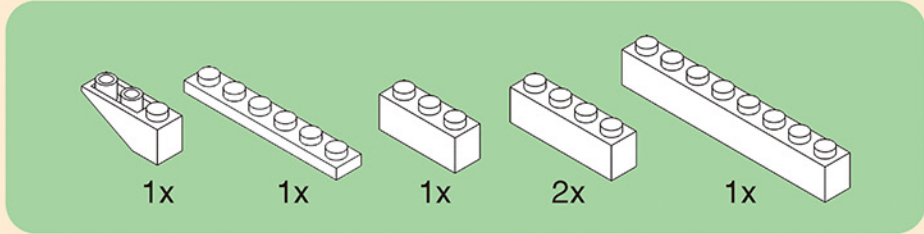

2-5

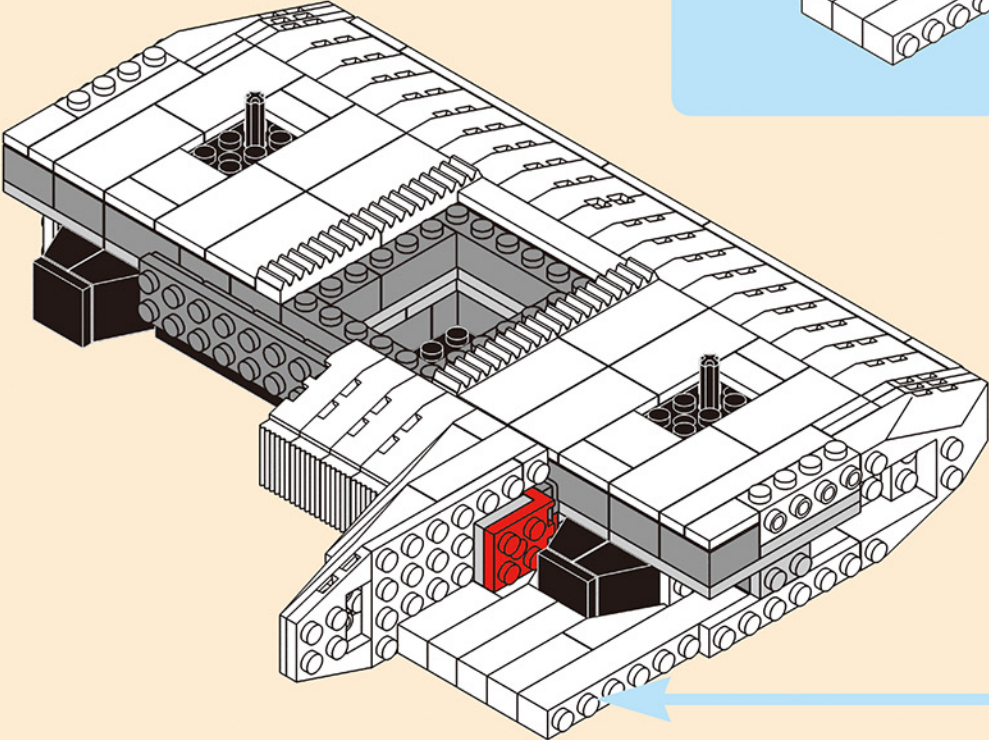
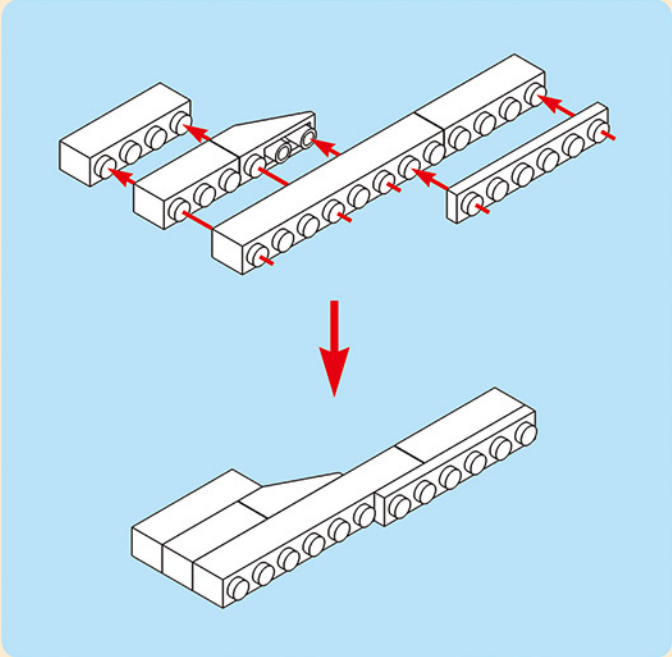

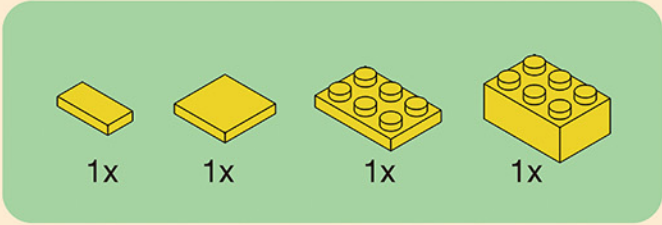

2-6

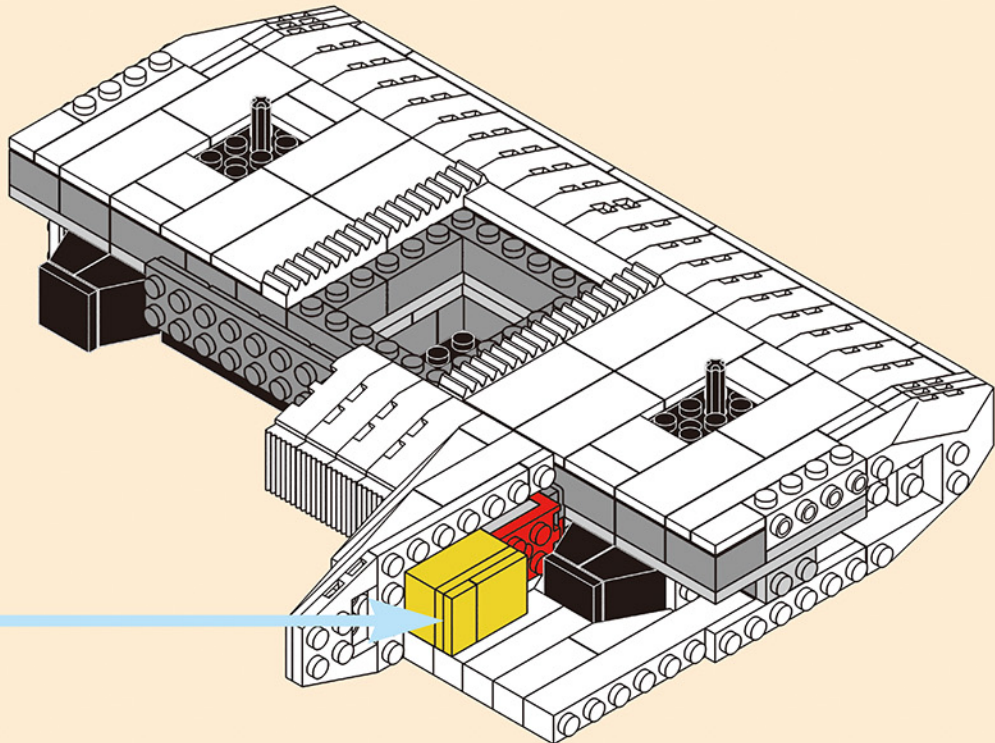
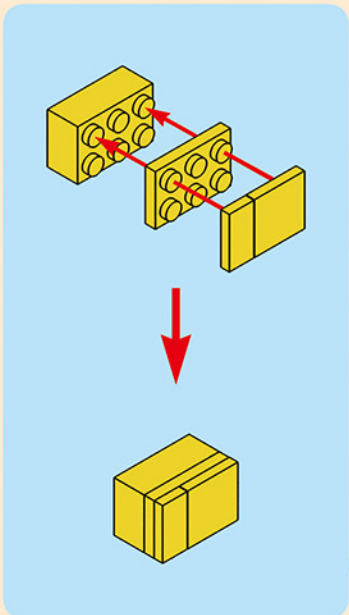

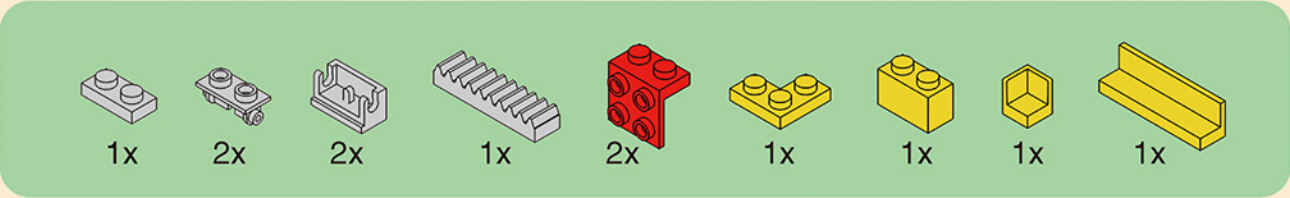

2-7.1

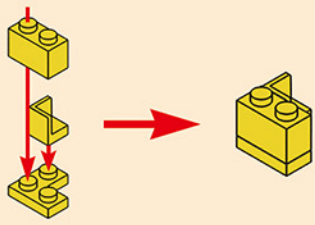

2-7.2

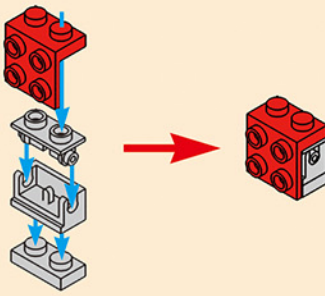

2-7.3

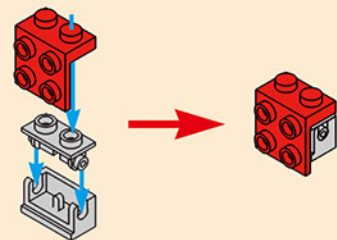

2-7.4

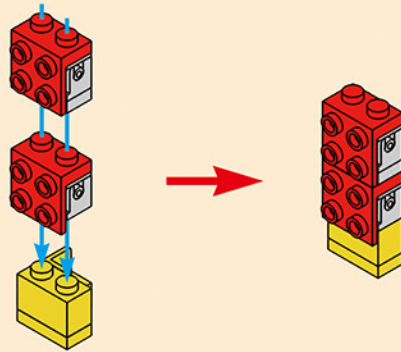

2-7.5

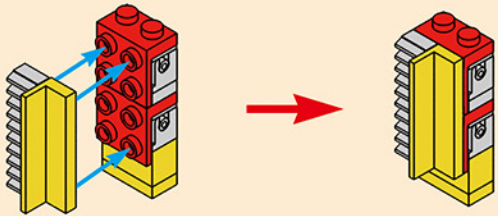

2-7

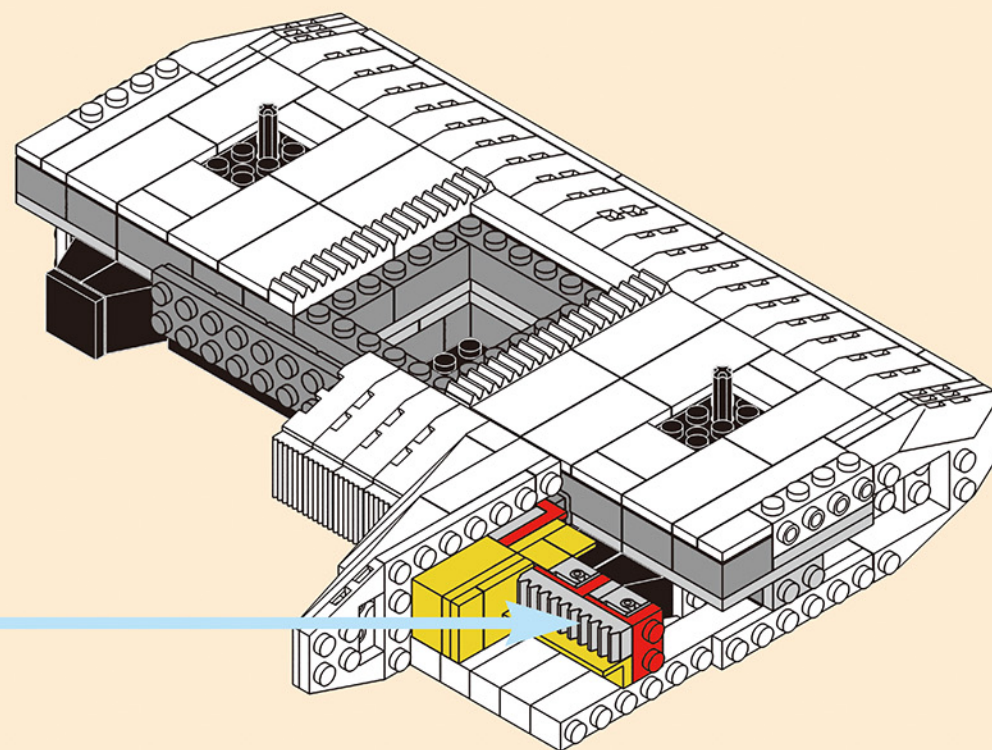
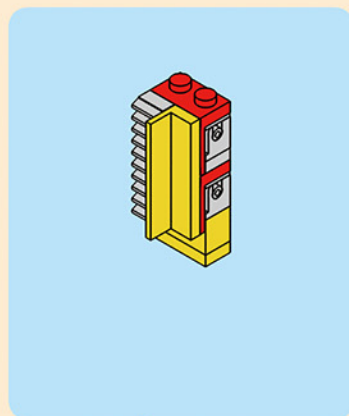

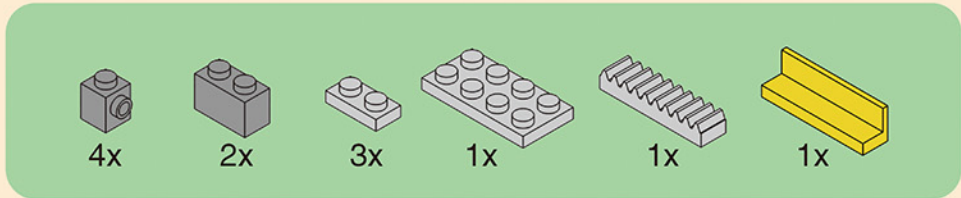

2-8.1

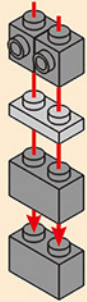

2-8.2

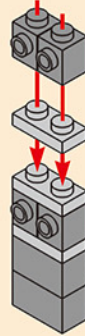

2-8.3

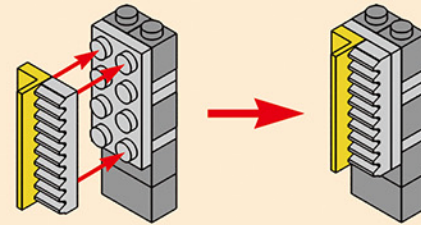

2-8

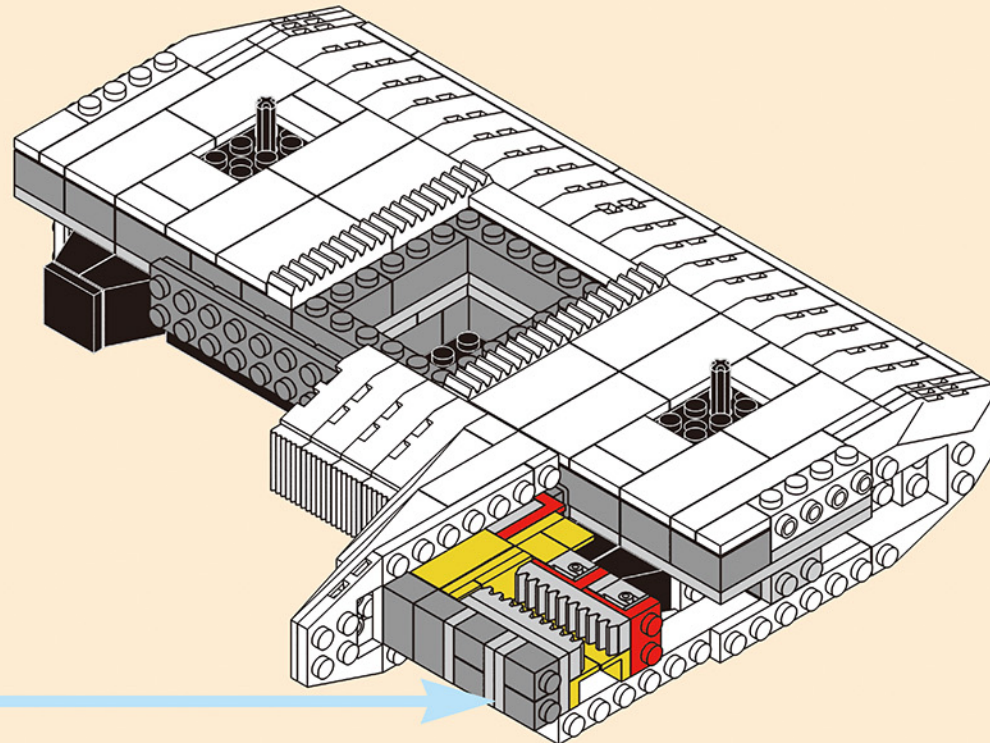
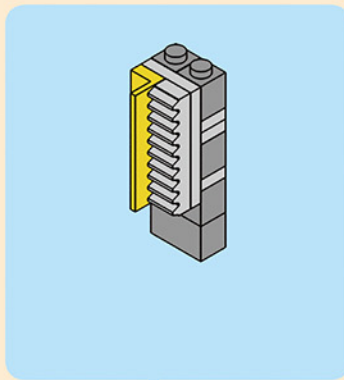

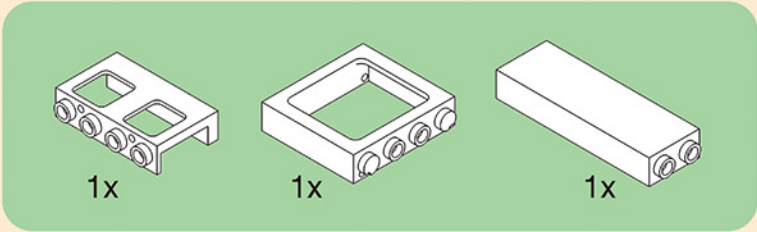

2-9

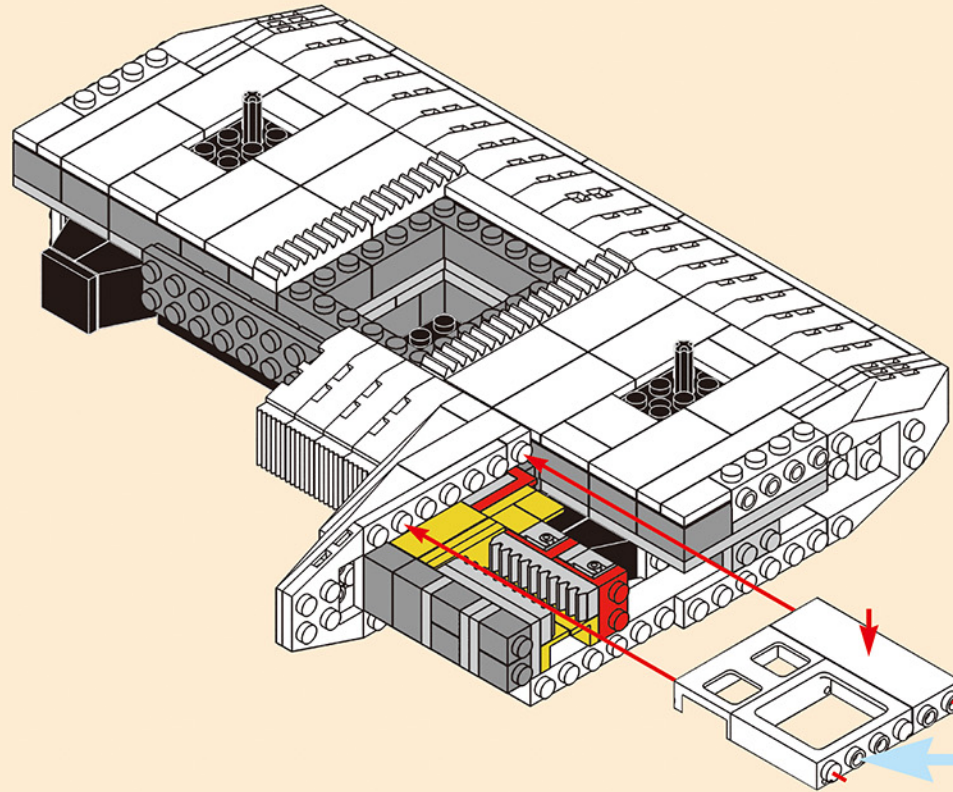
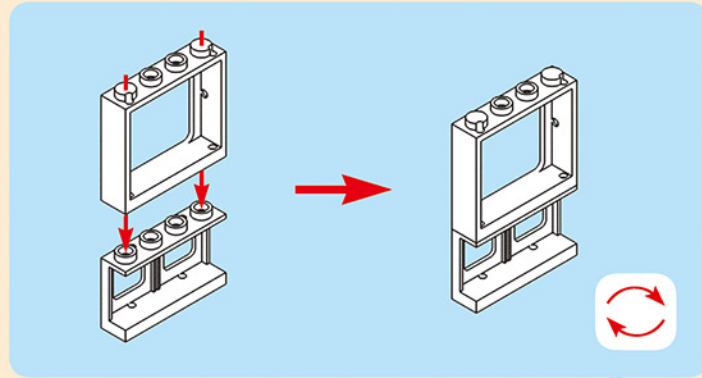

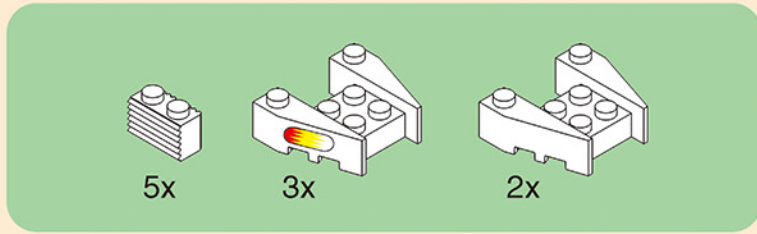

2-10.1

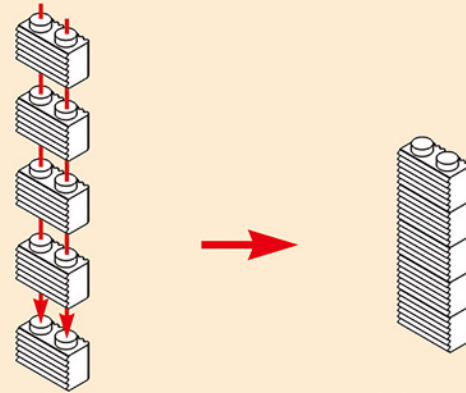

2-10.2

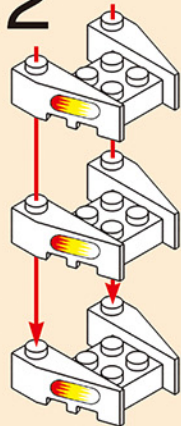

2-10.3

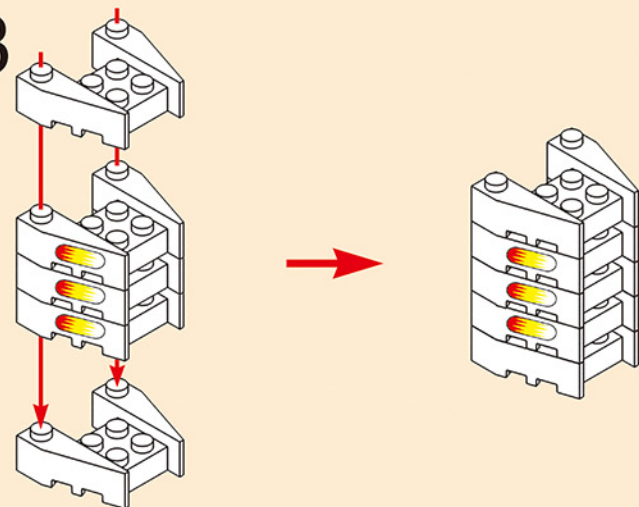

2-10

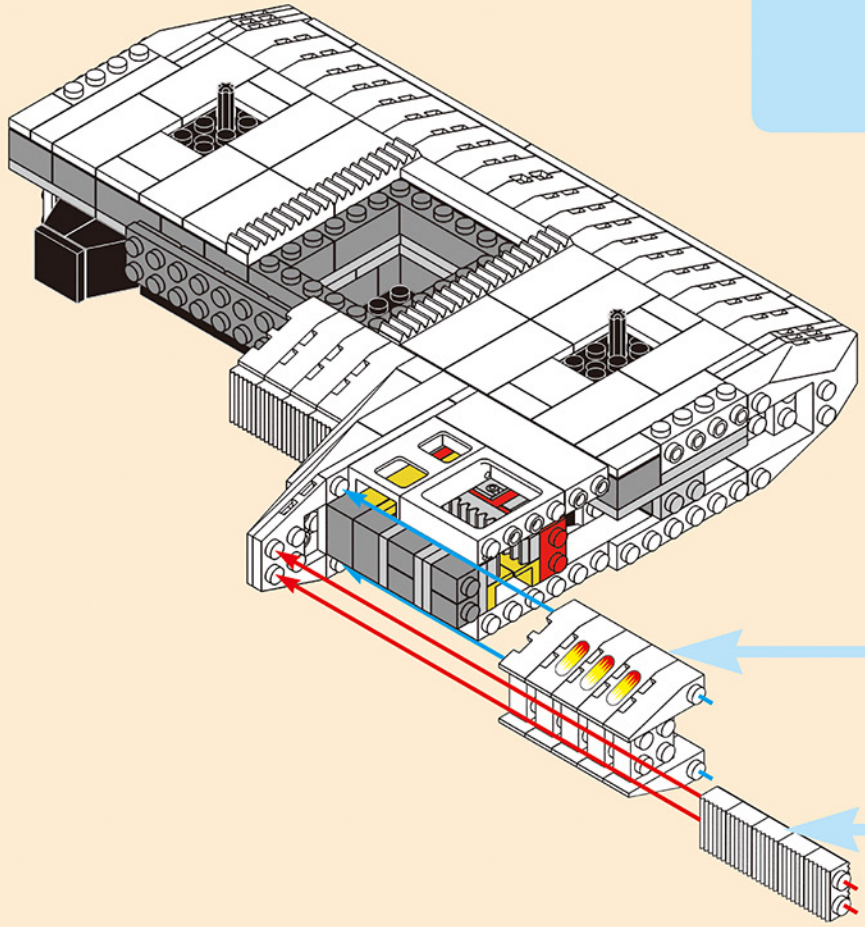
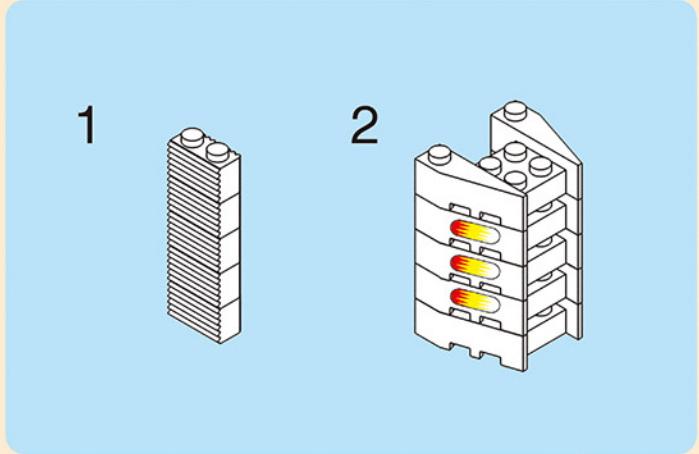

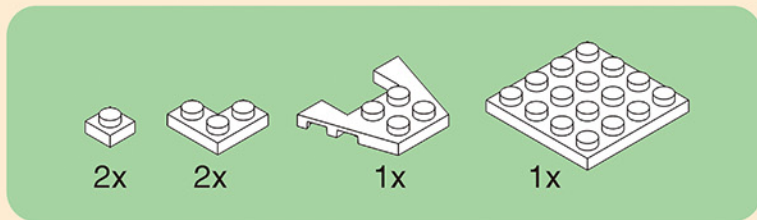

2-11

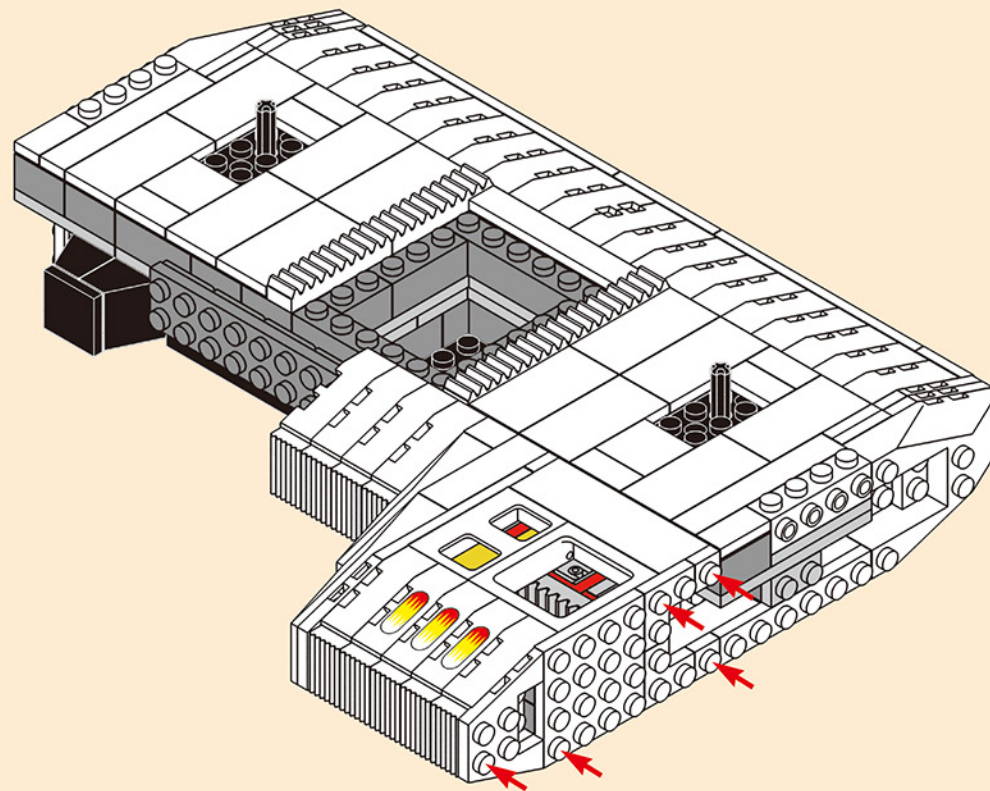

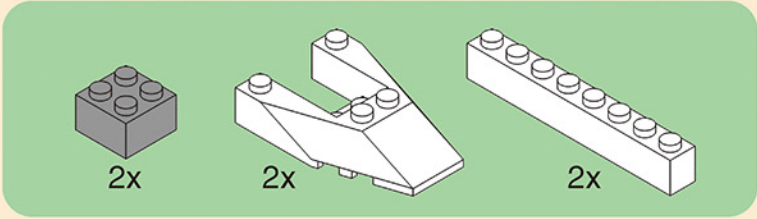

2-12

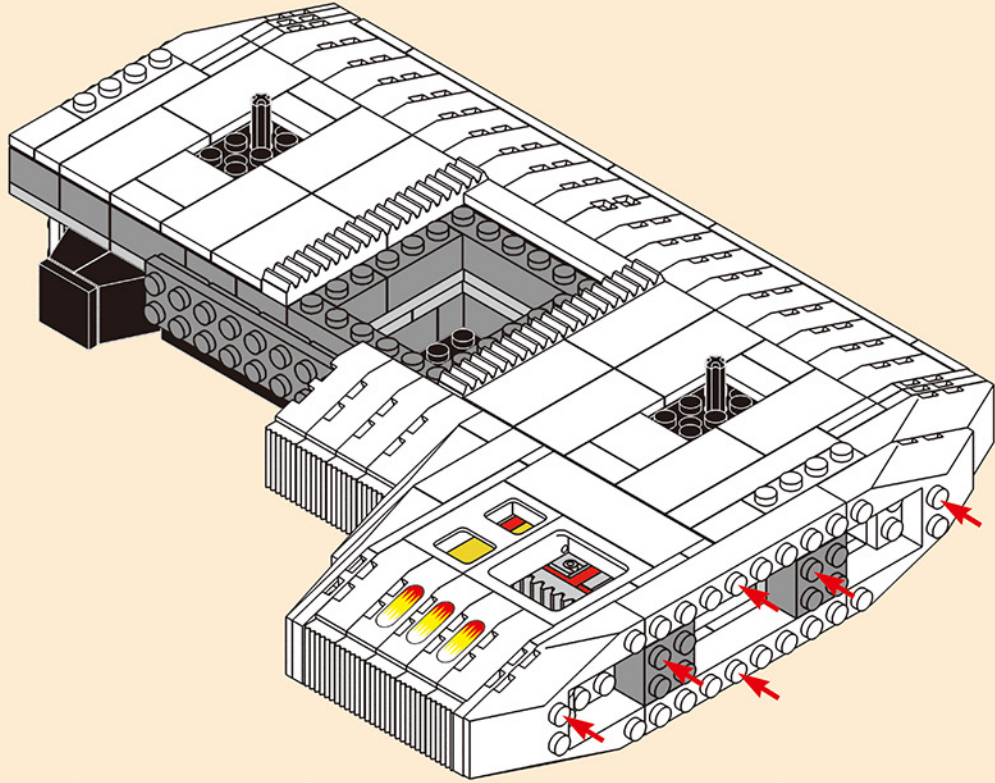

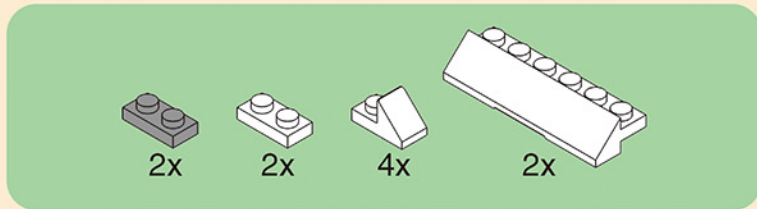

2-13

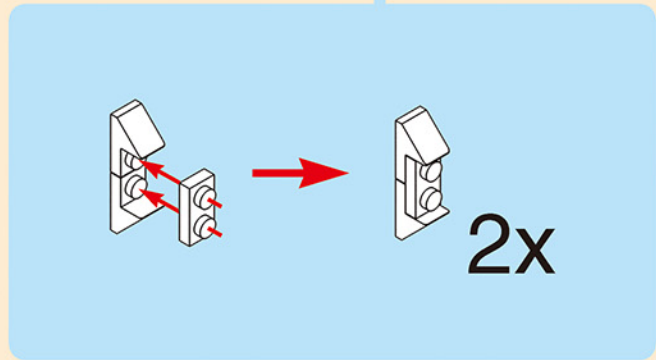
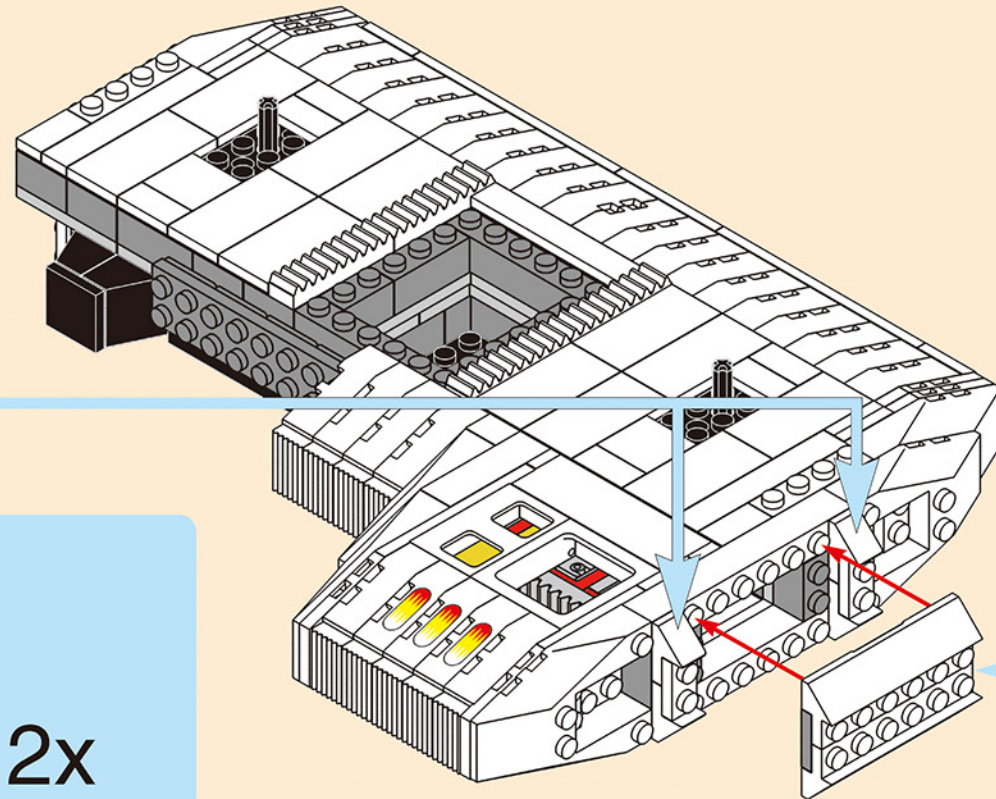
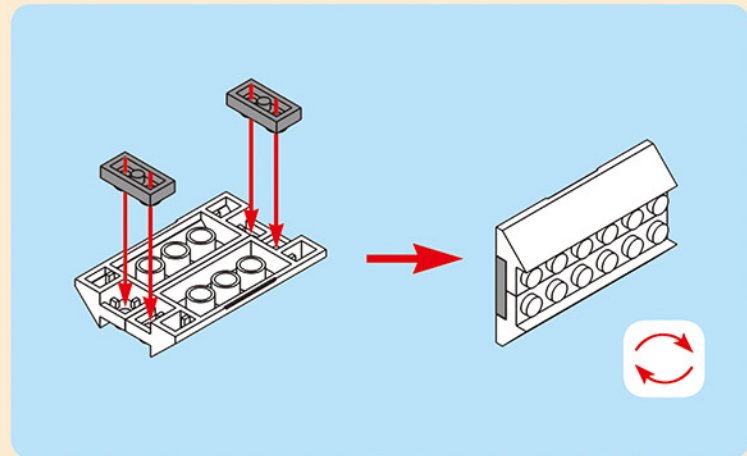

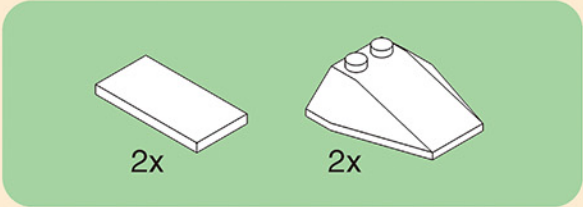

2-14

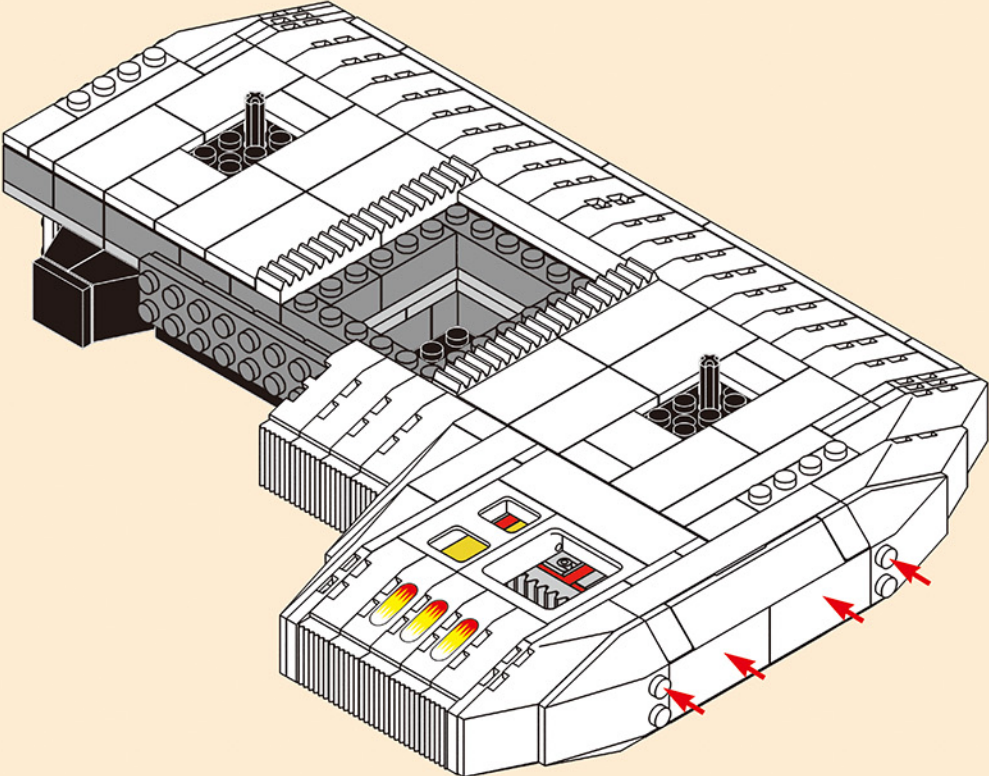

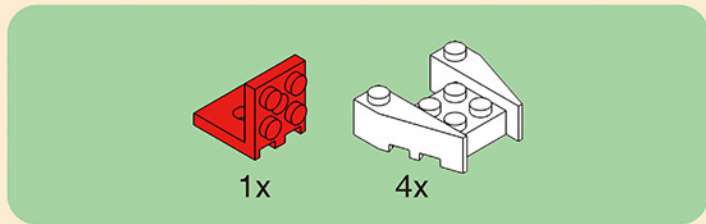

2-15.1

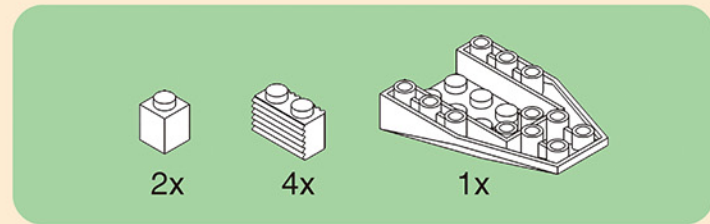
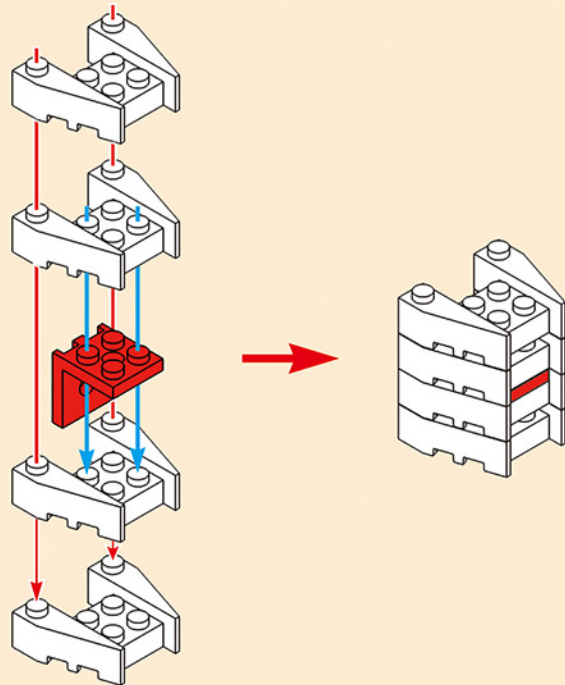

2-15.2

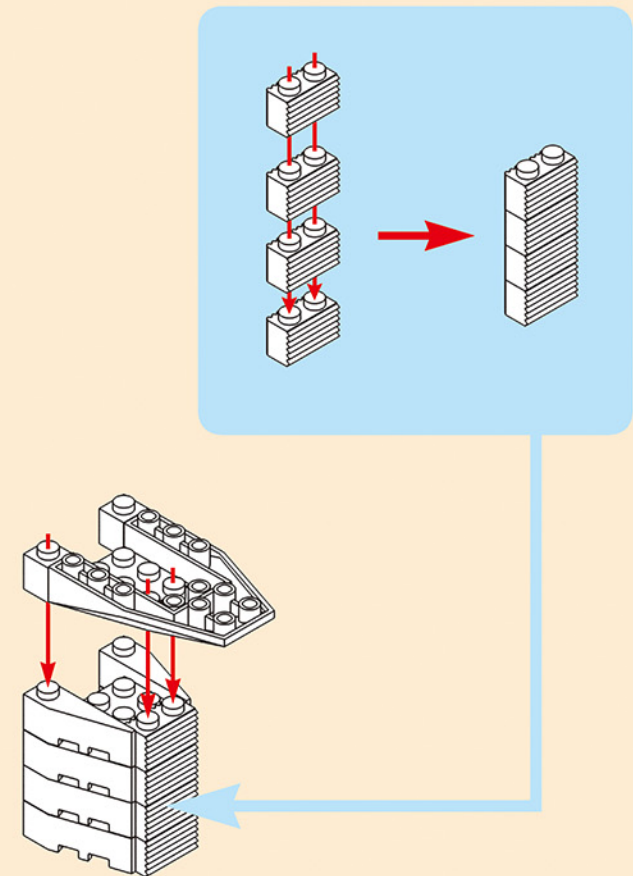

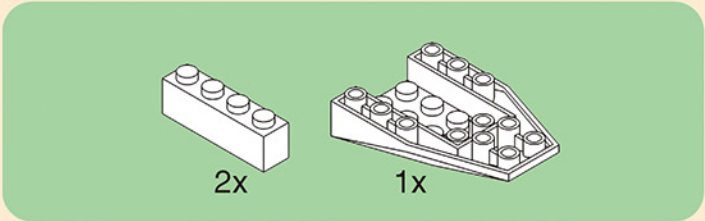

2-15.3

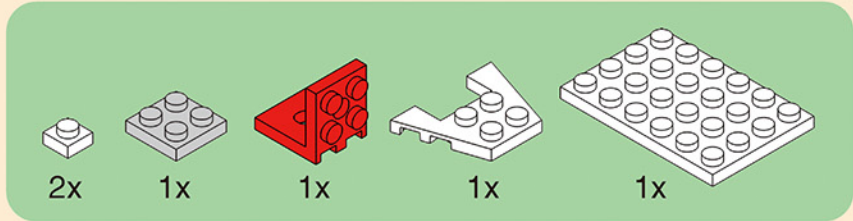
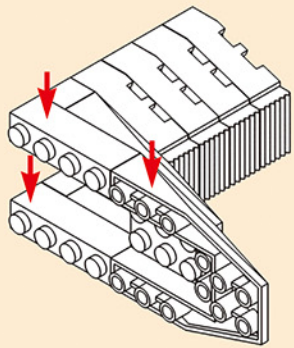

2-15.4

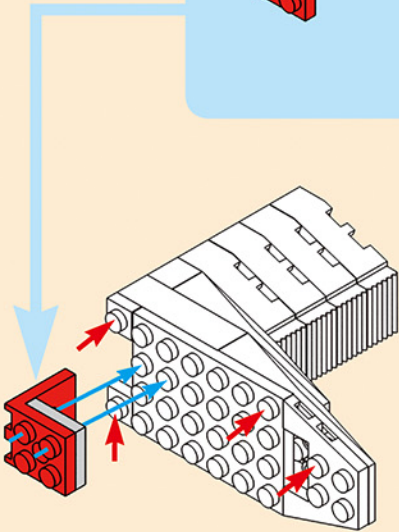
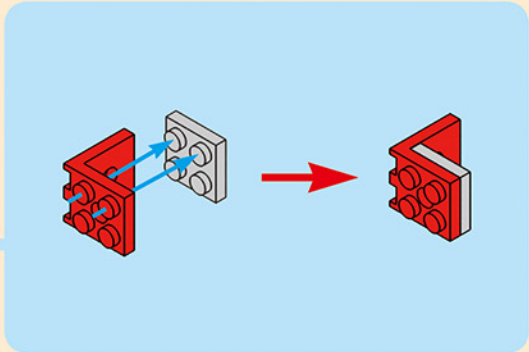

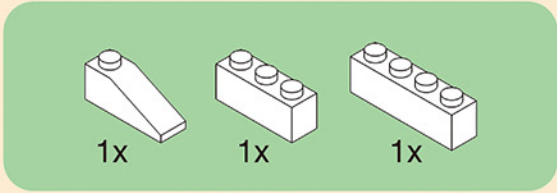

2-15.5

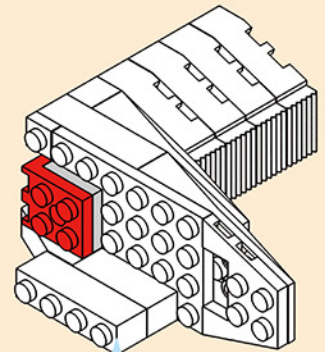
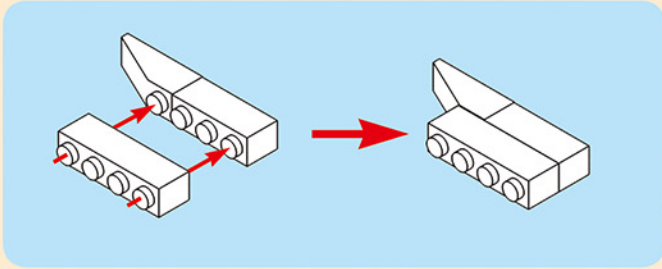

2-15

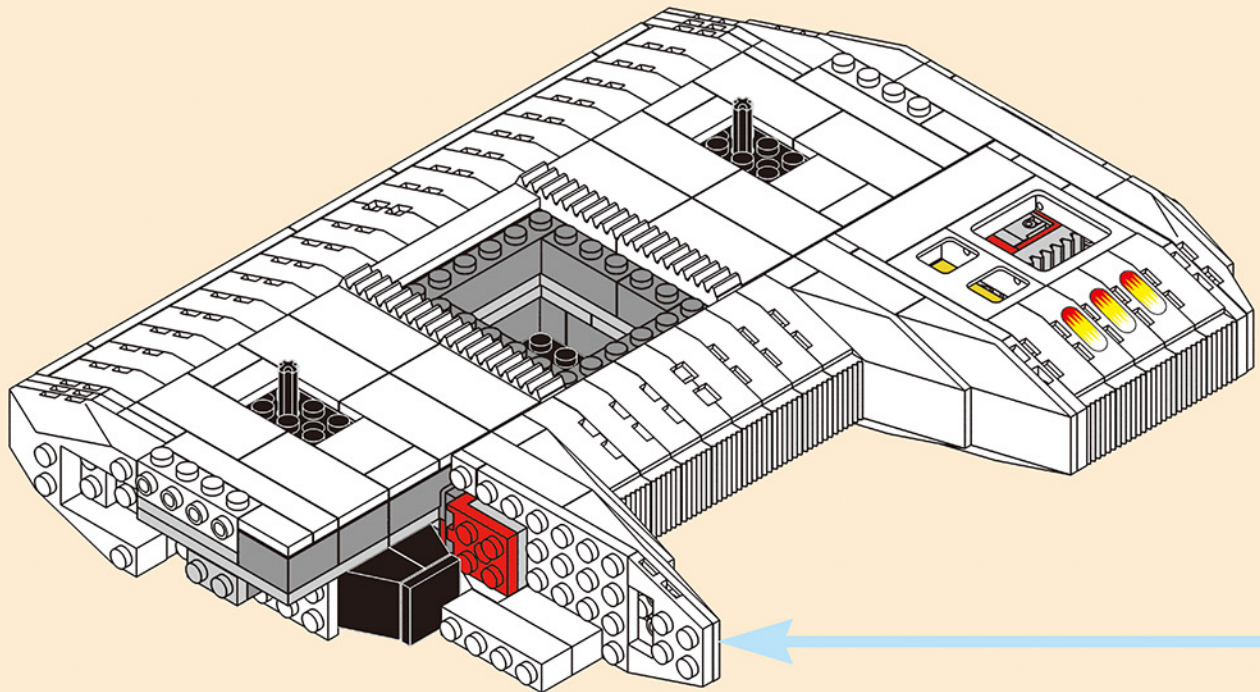

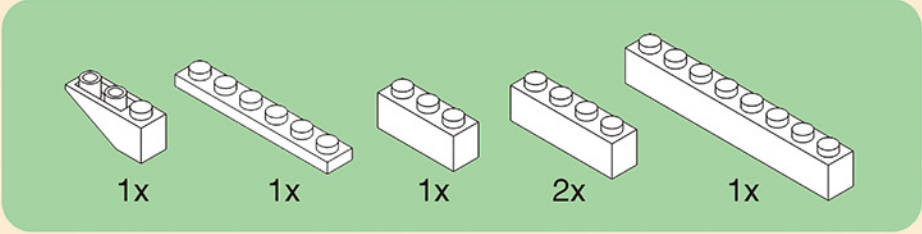
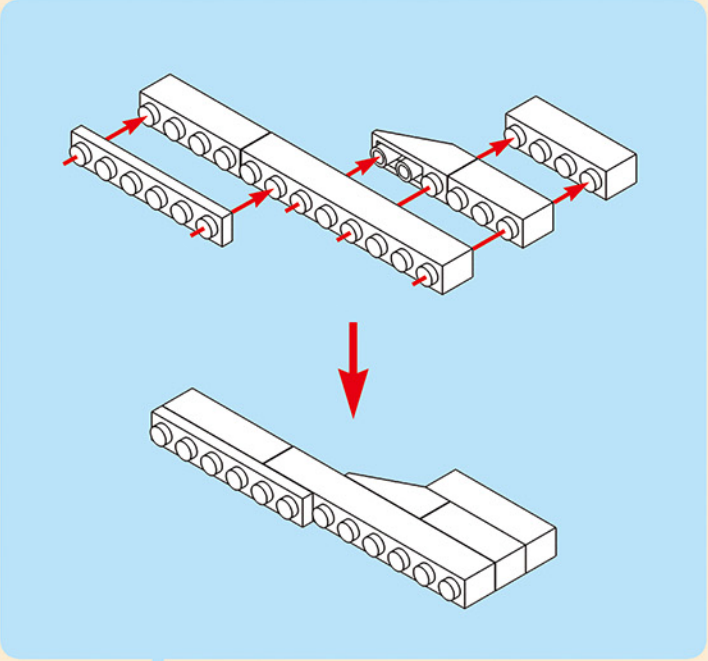

2-16

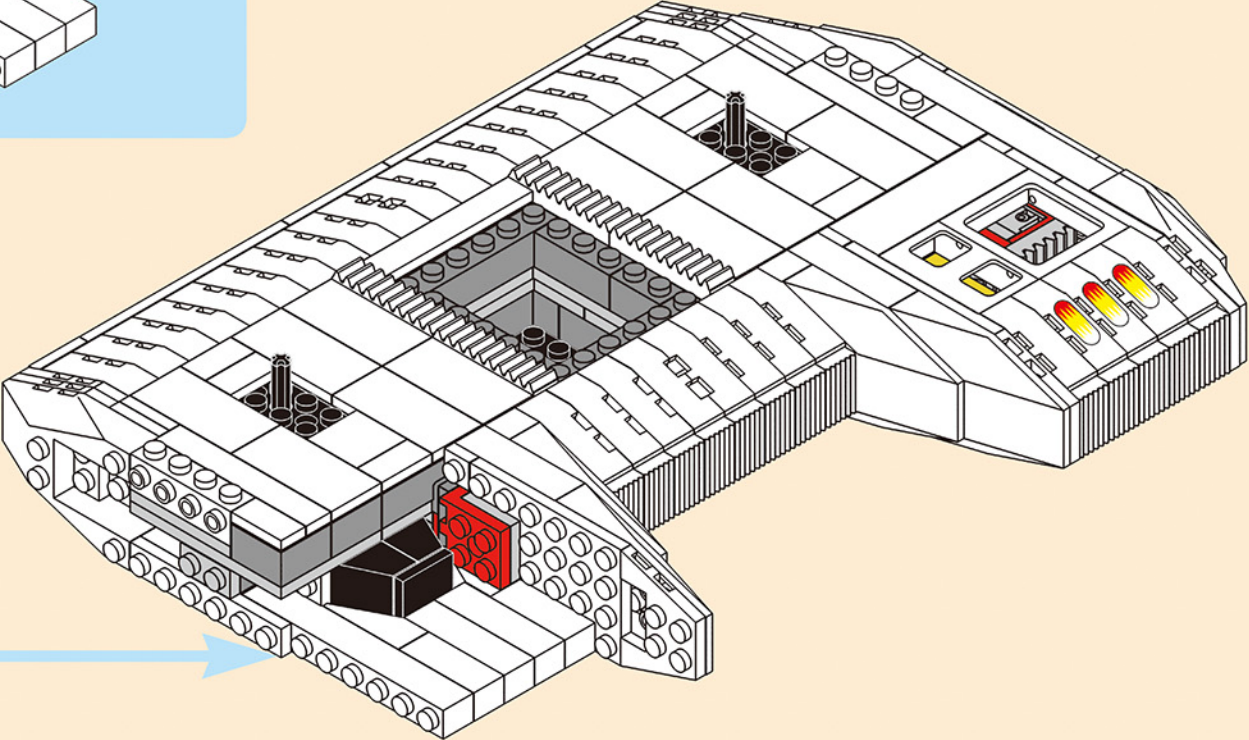

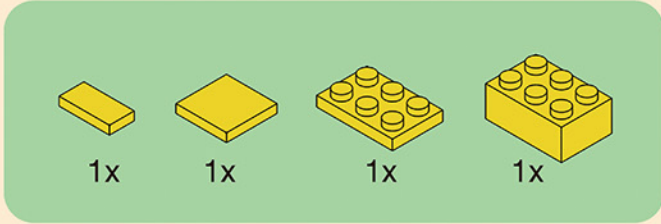

2-17

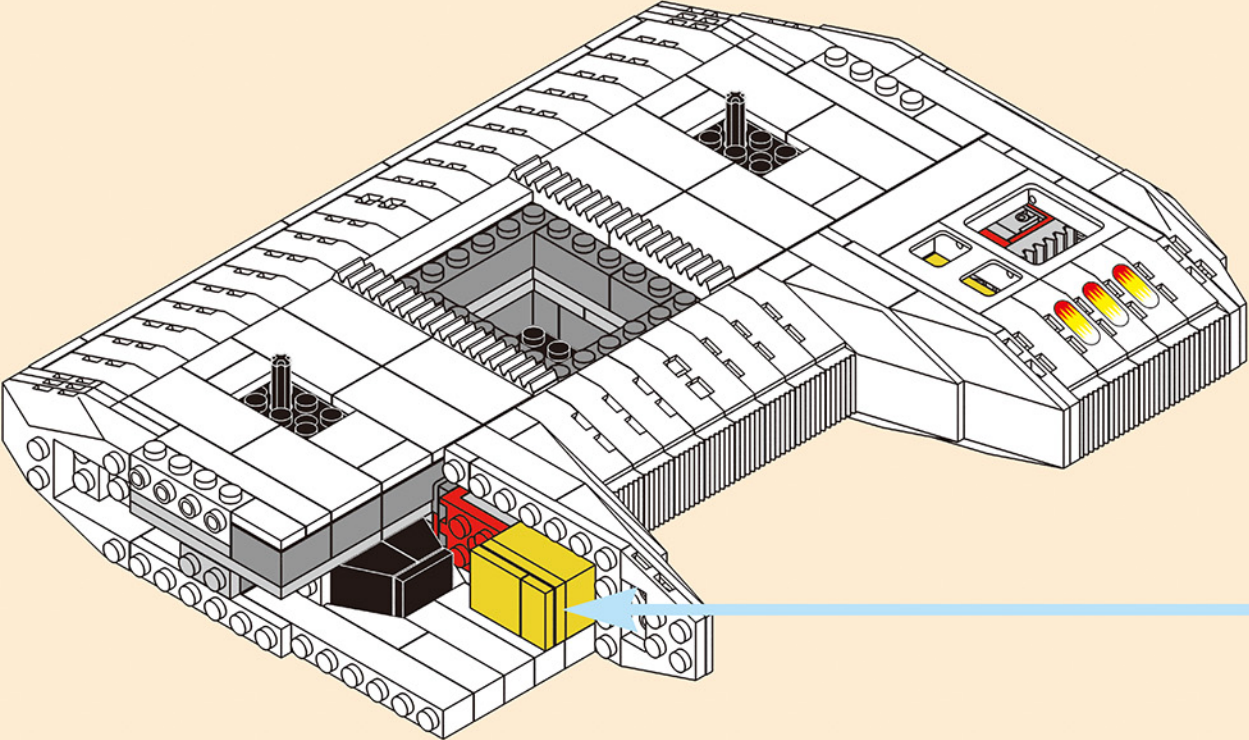
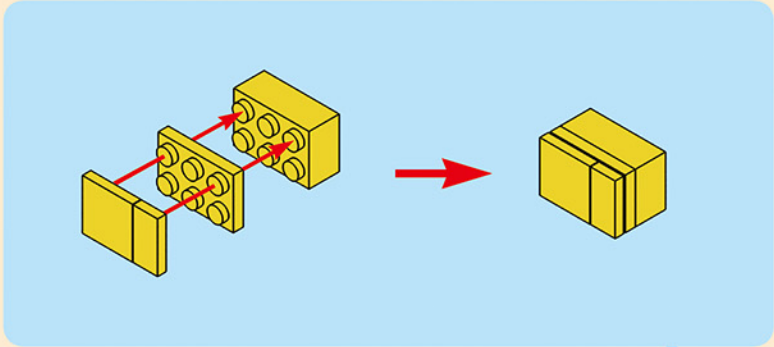

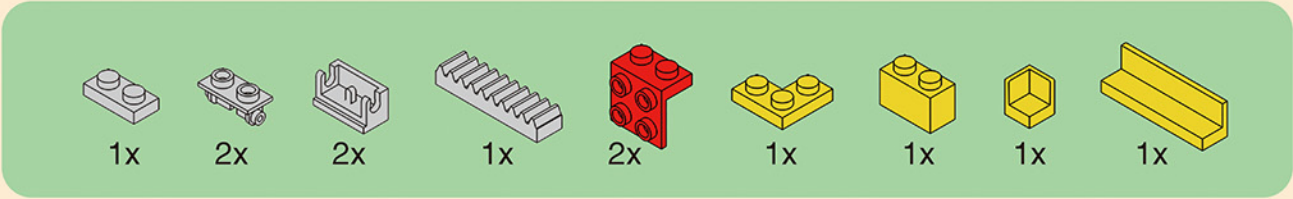

2-18.1

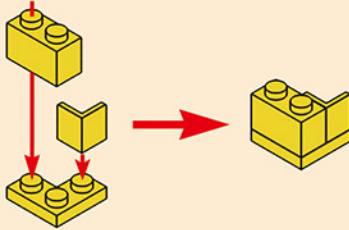

2-18.2

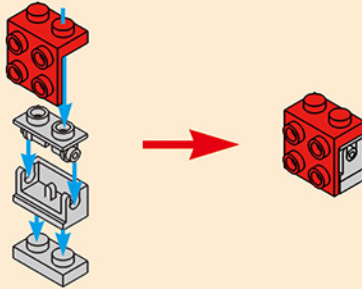

2-18.3

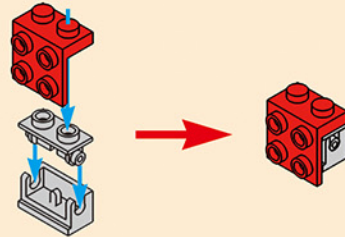

2-18.4

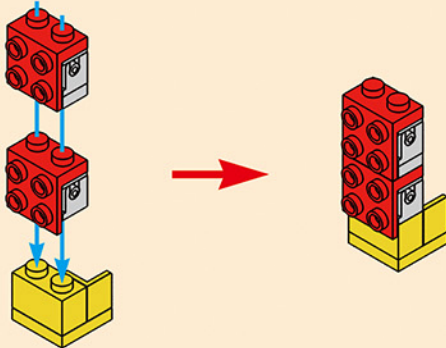

2-18.5

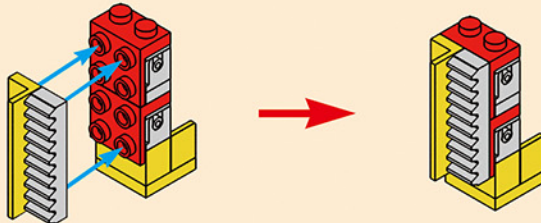

2-18

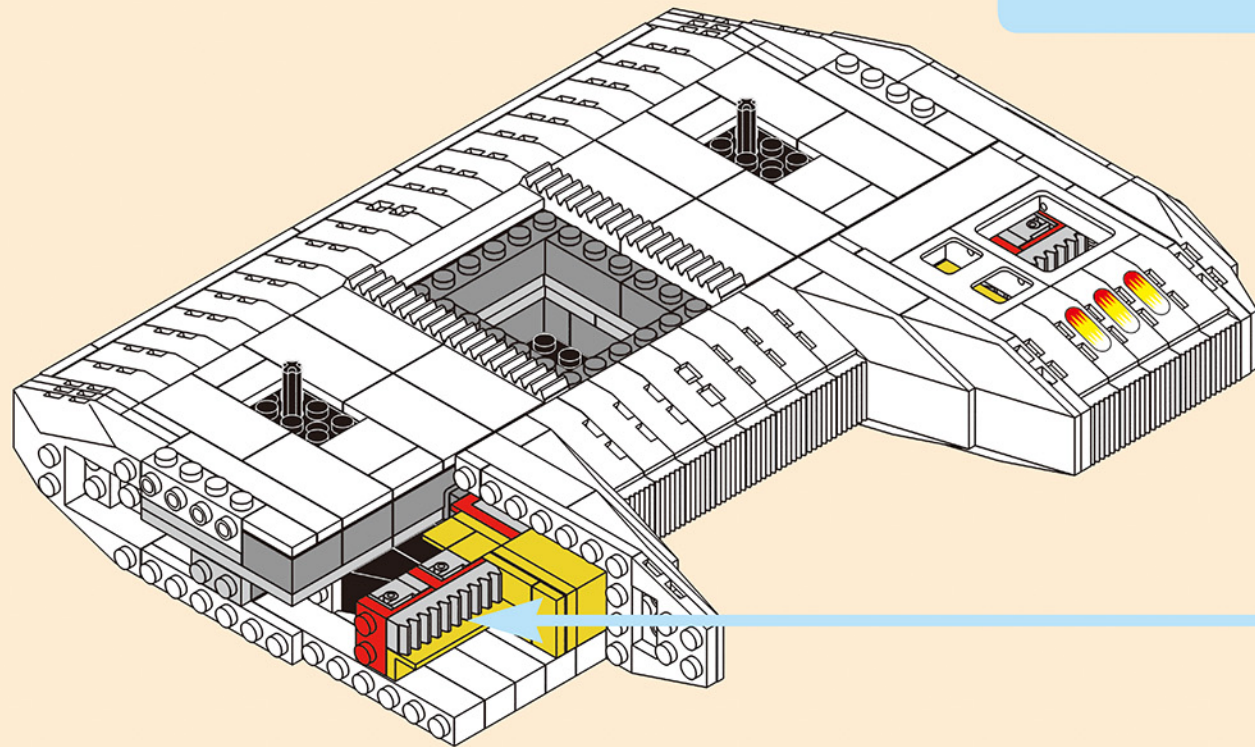
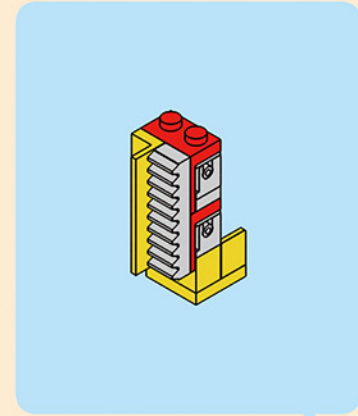

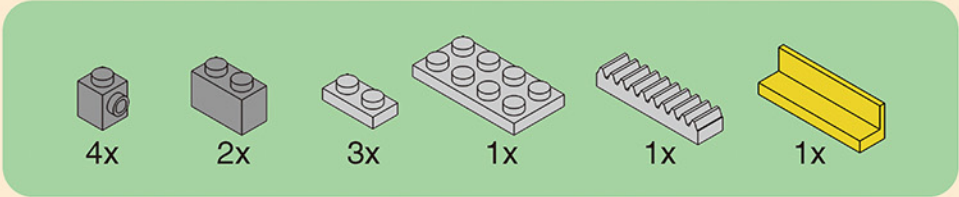

2-19.1

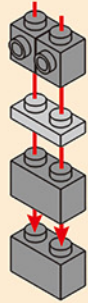

2-19.2

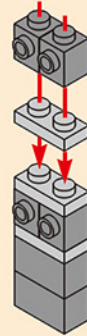

2-19.3

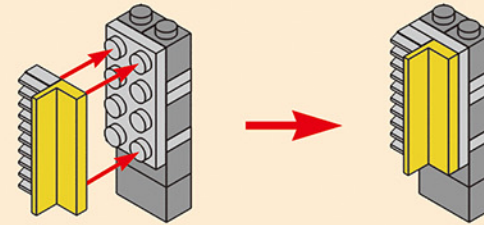

2-19

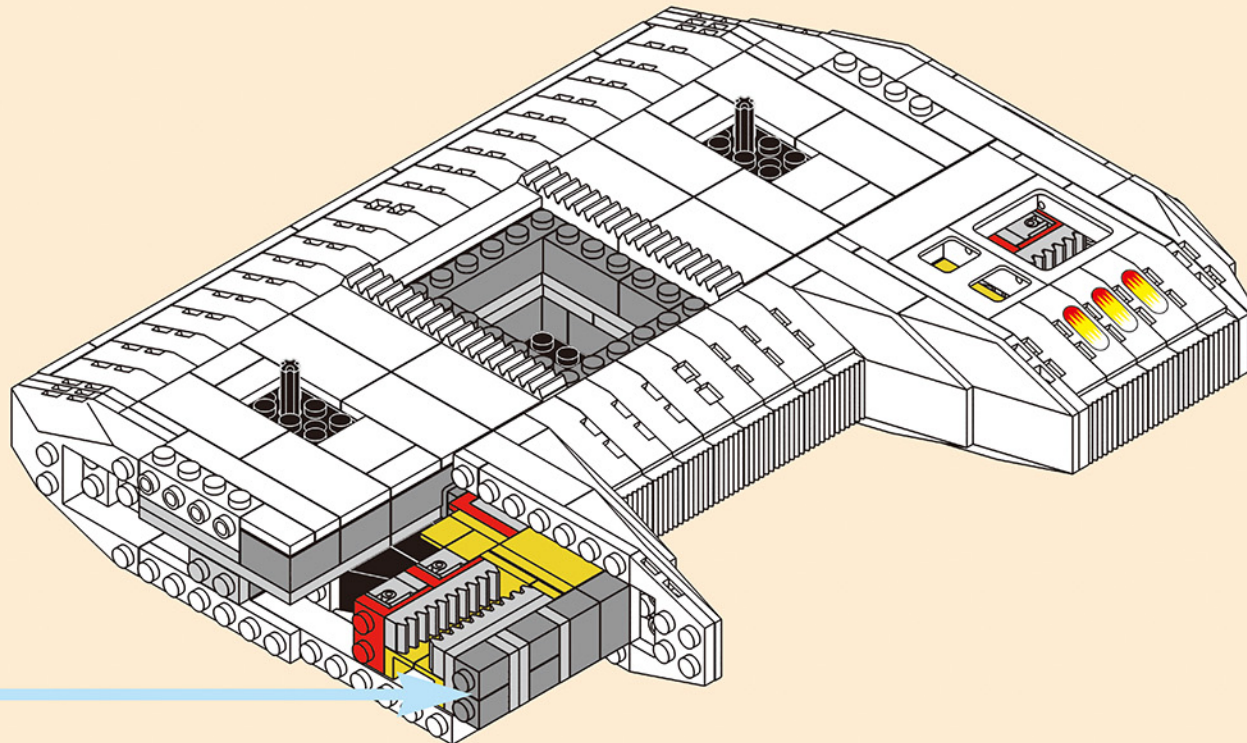
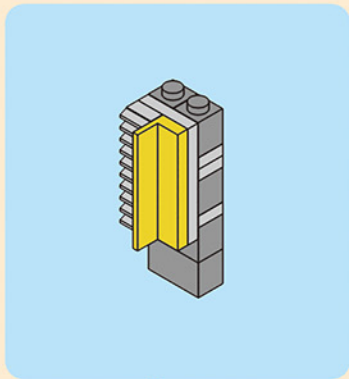

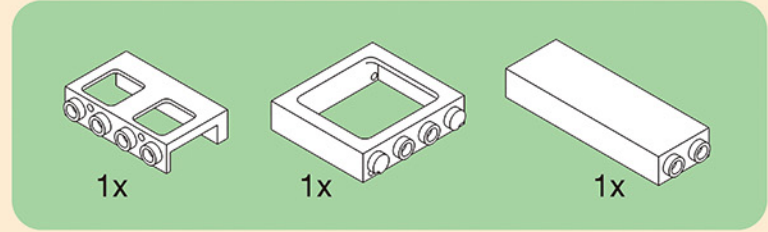
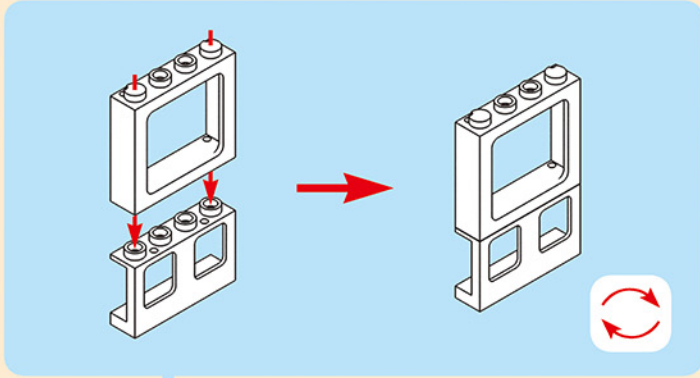

2-20

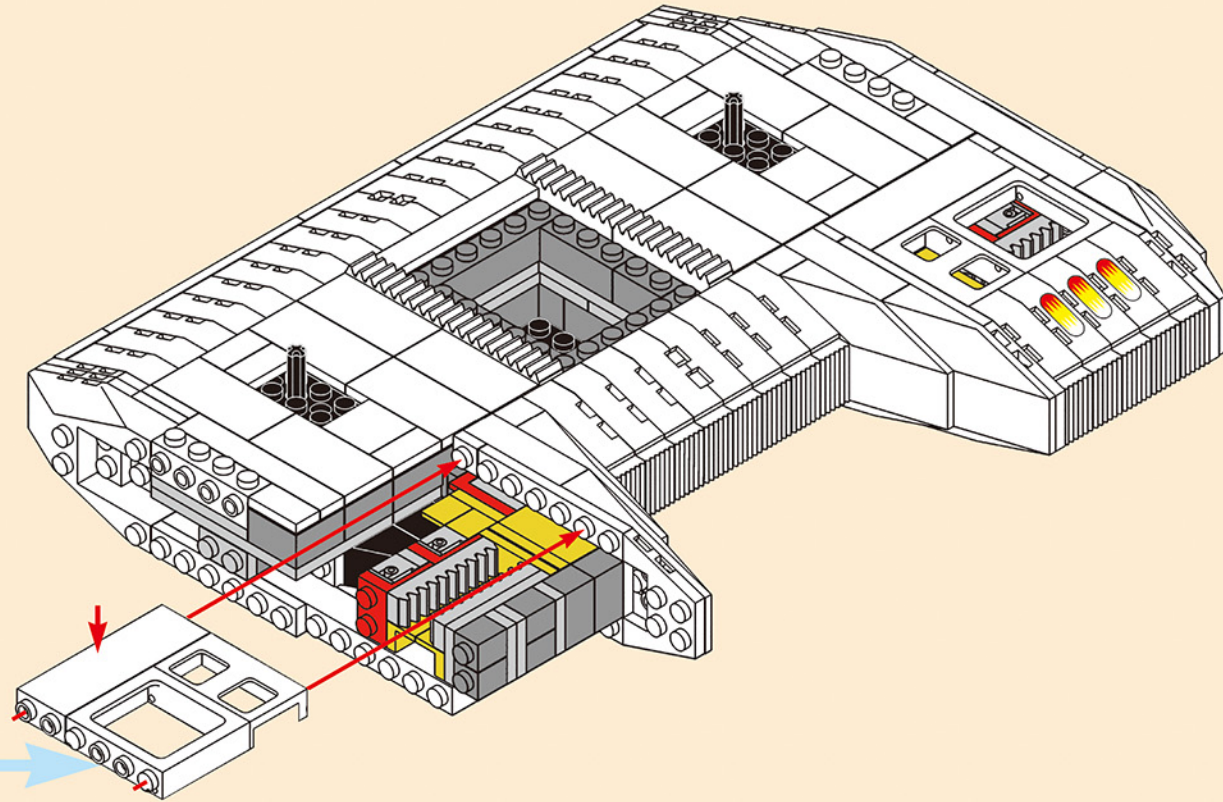

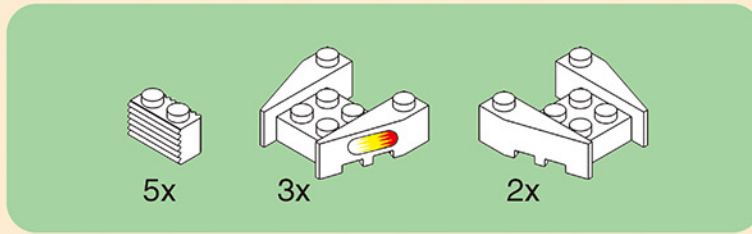

2-21.1

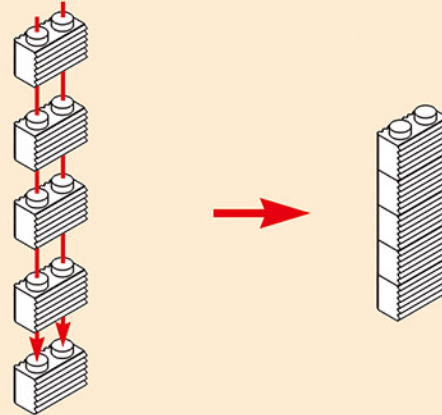

2-21.2

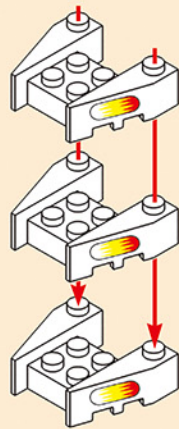

2-21.3

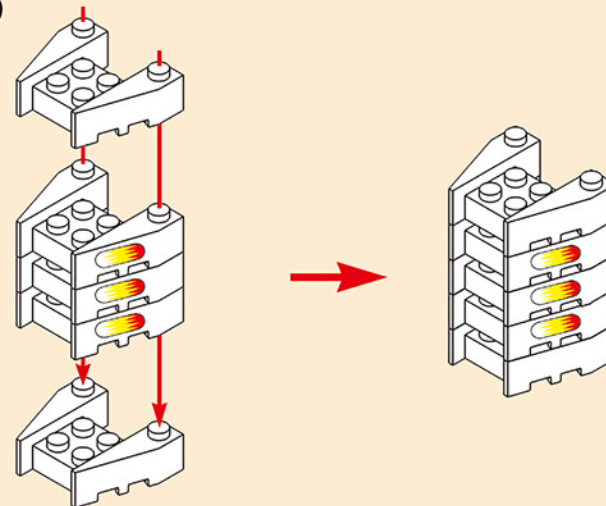

2-21

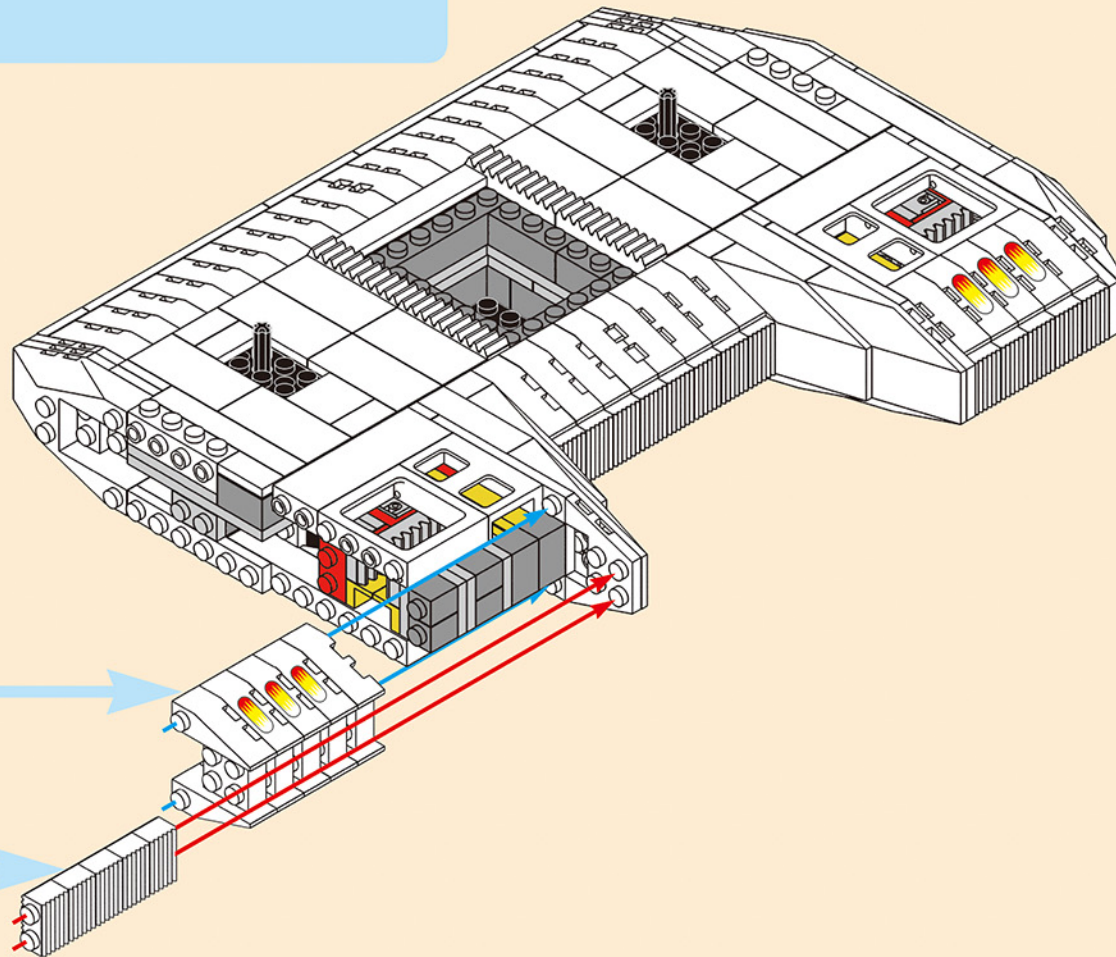
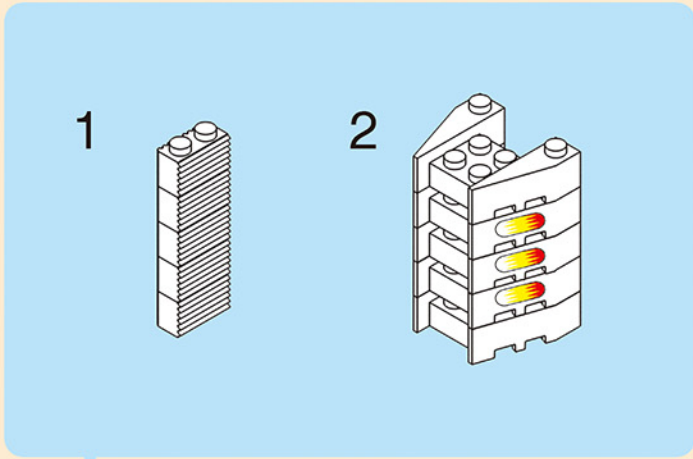

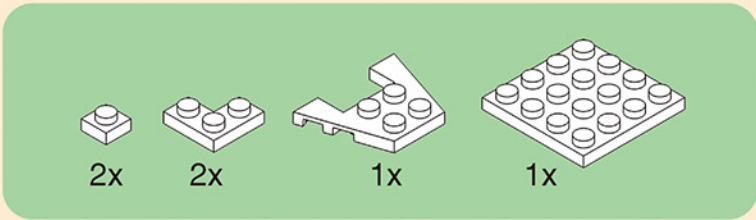

2-22

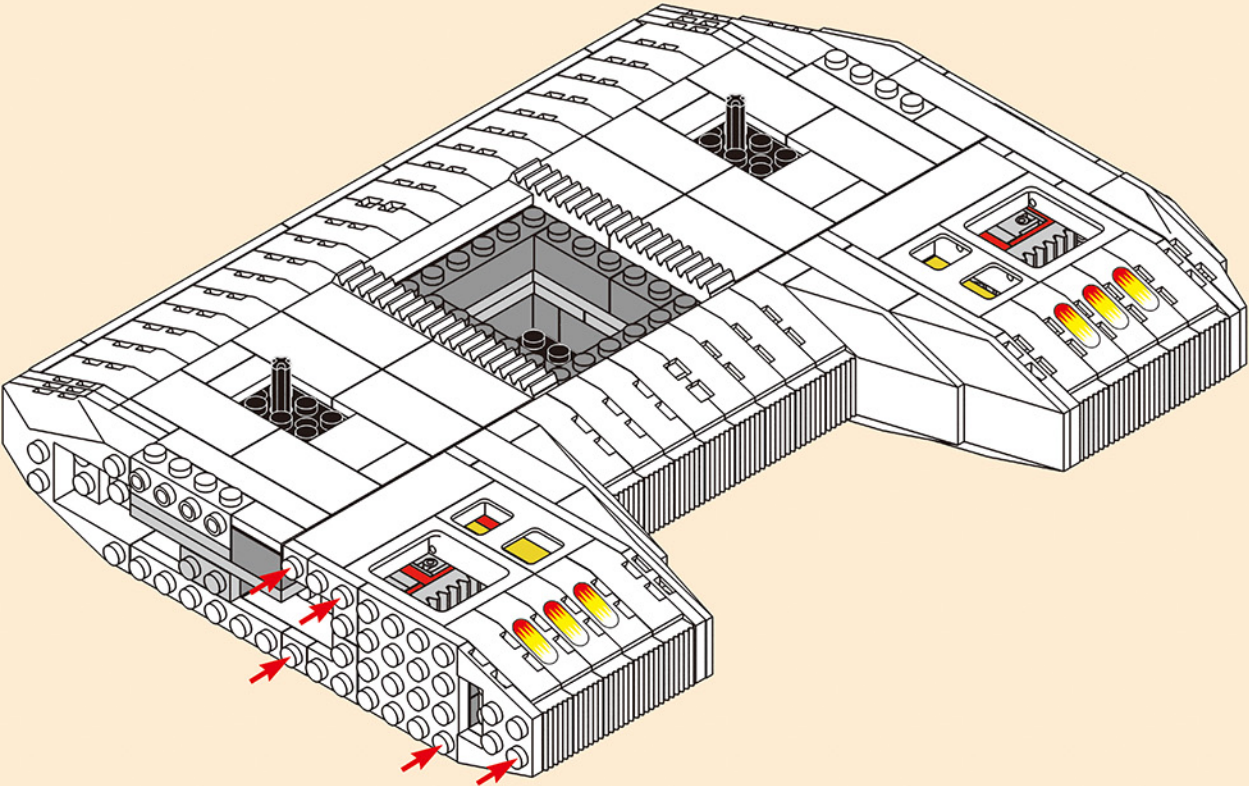

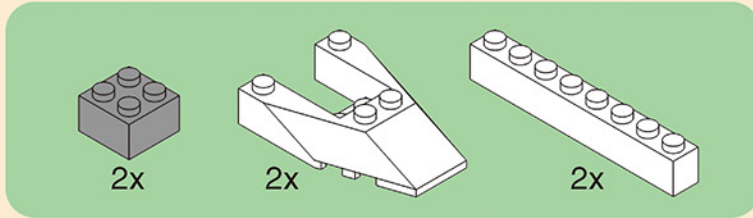

2-23

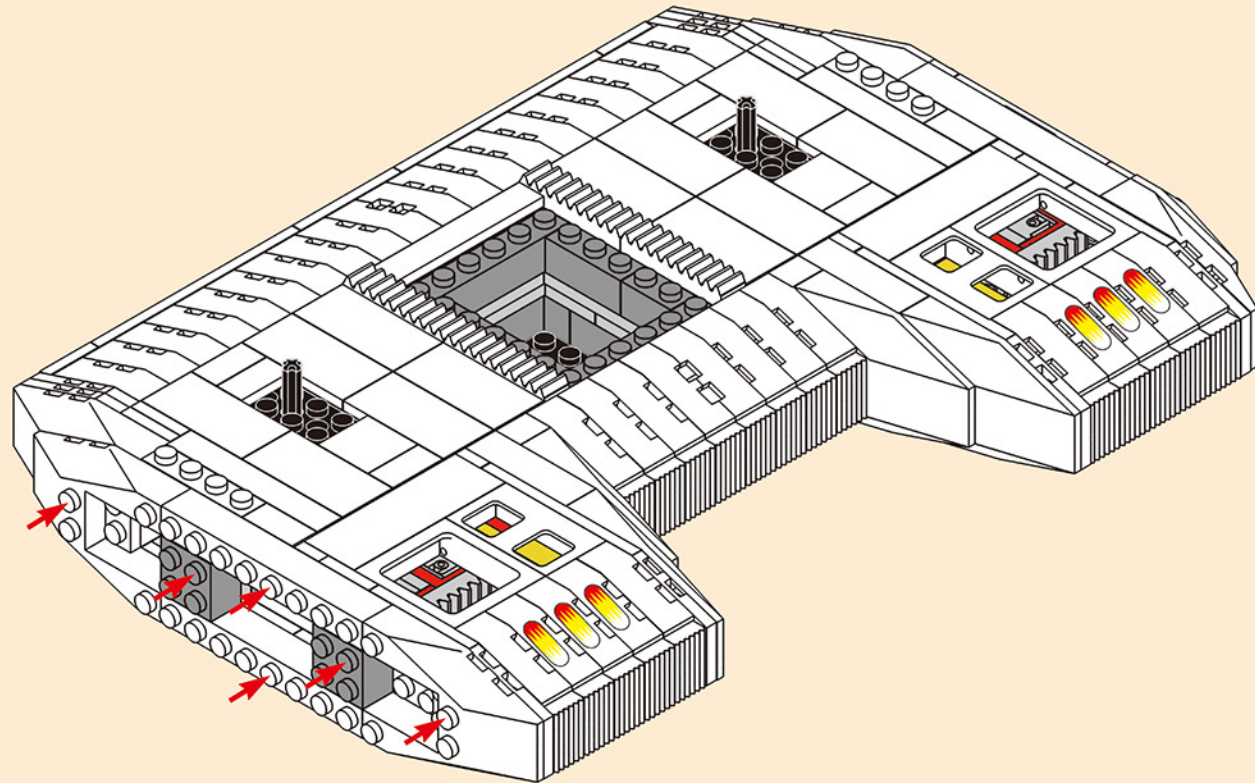

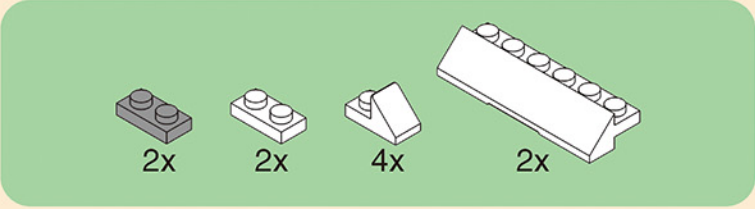

2-24

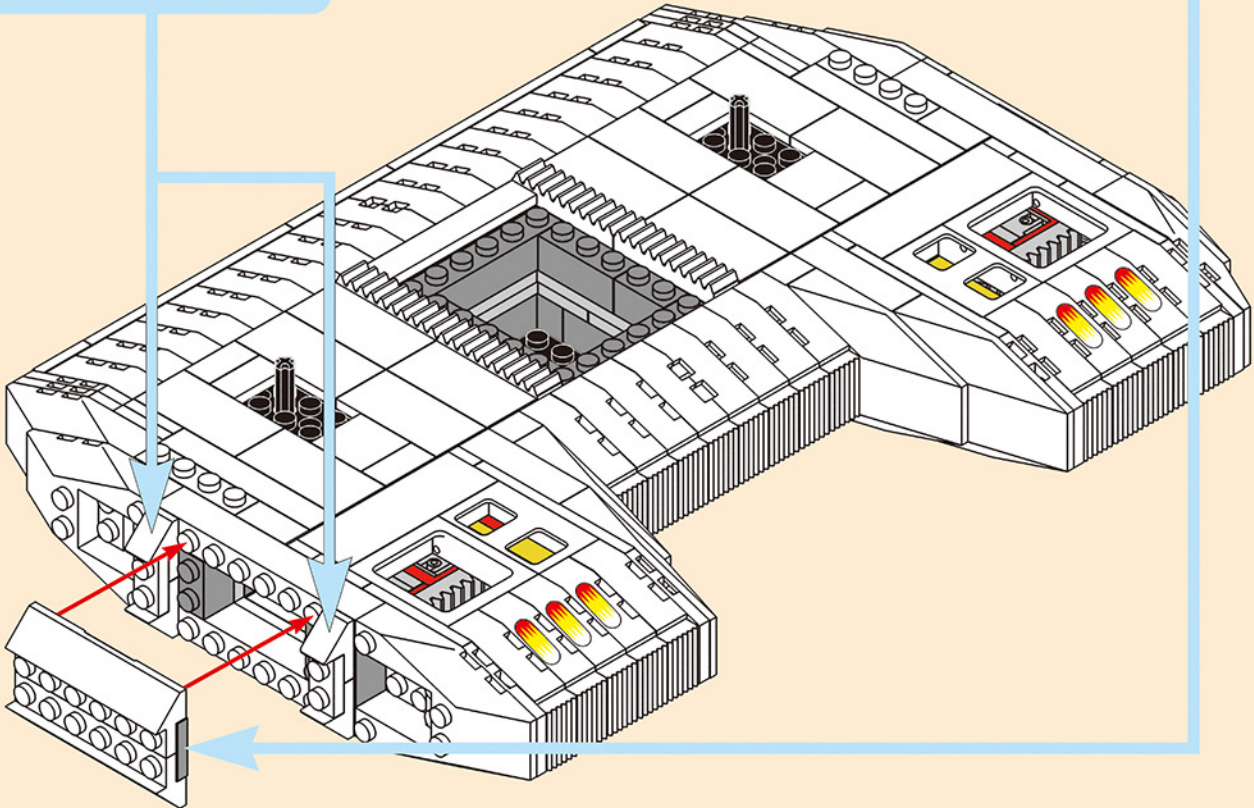
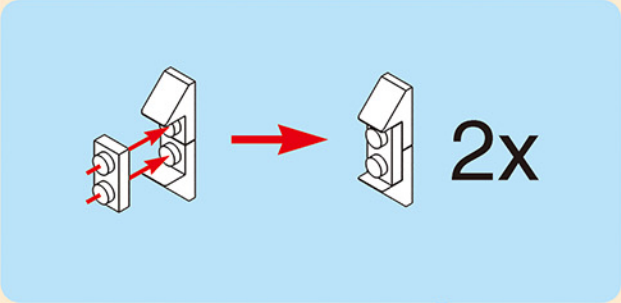
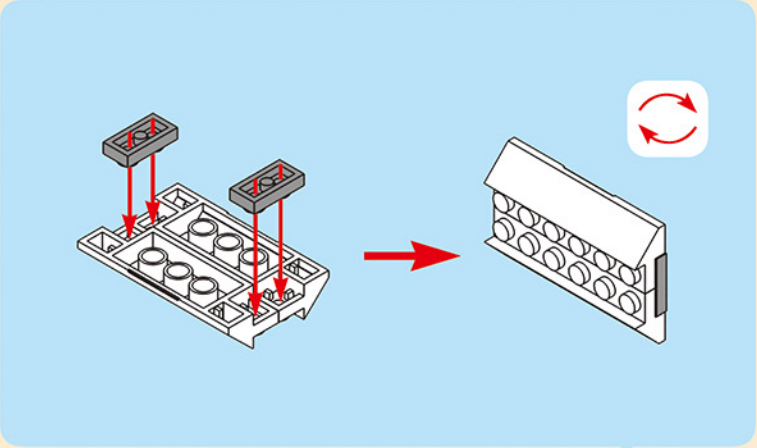

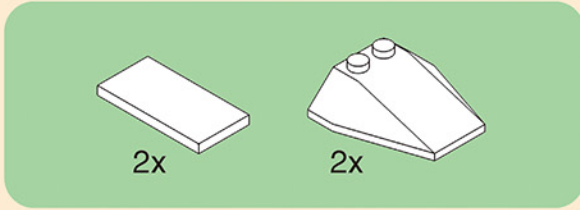

2-25

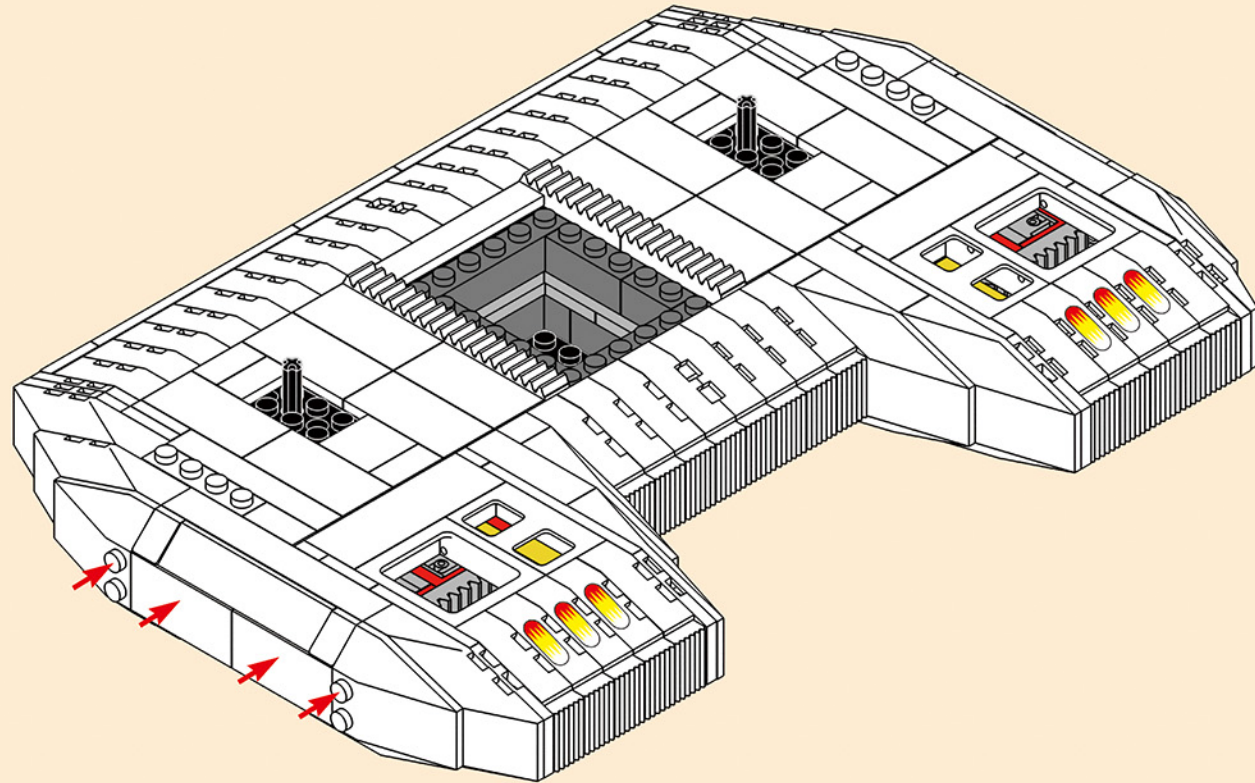

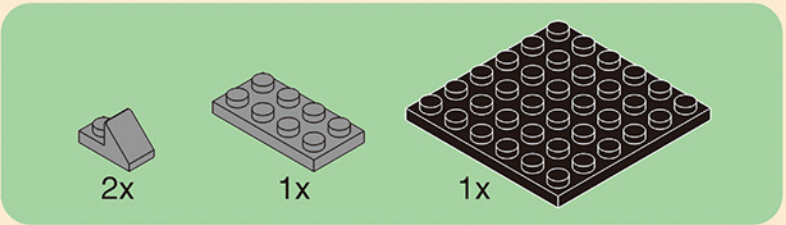

2-26.1

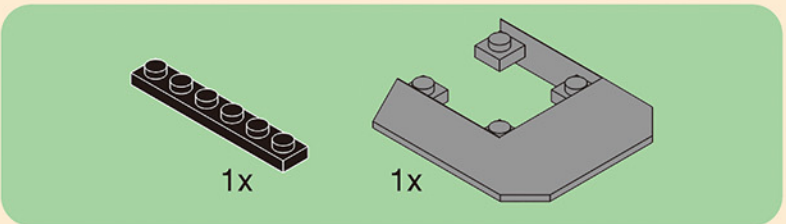
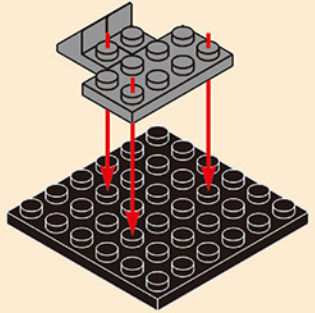

2-26.2

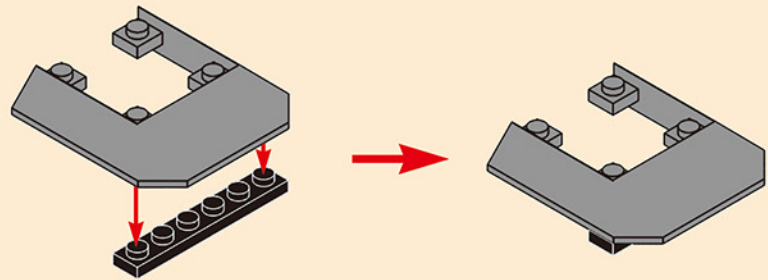

2-26.3

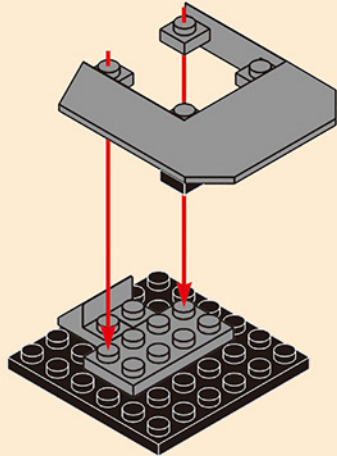

2-26.4

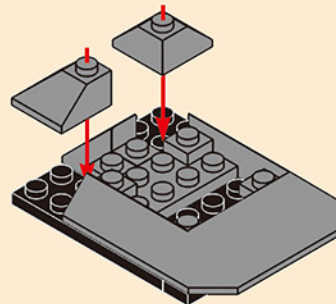

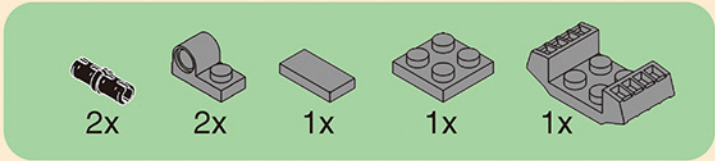

2-26.5

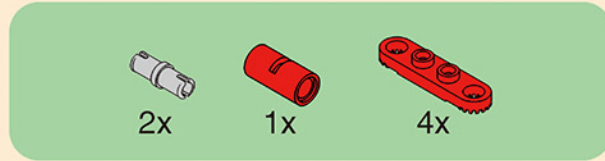
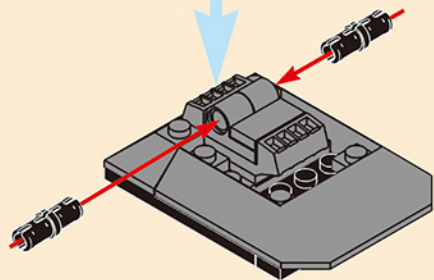
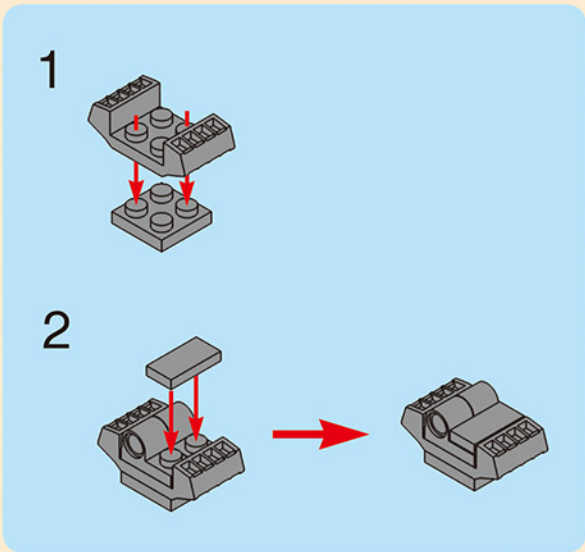

2-26.6

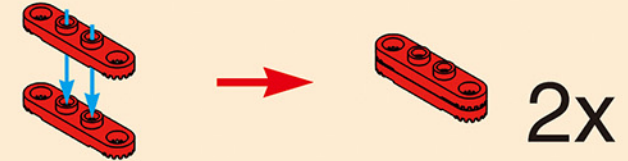

2-26.7

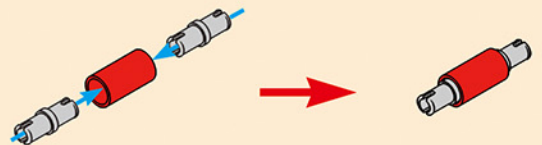

2-26.8

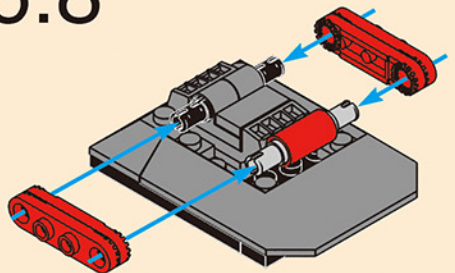

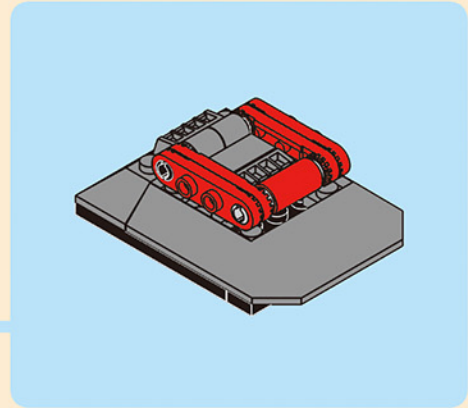
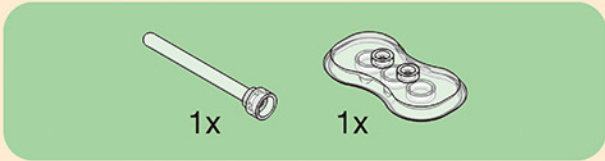

2-26.9

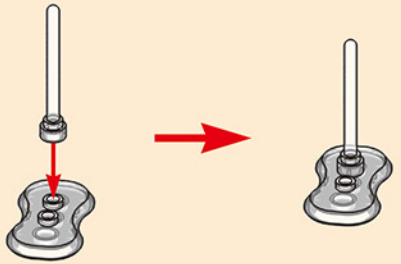

2-26

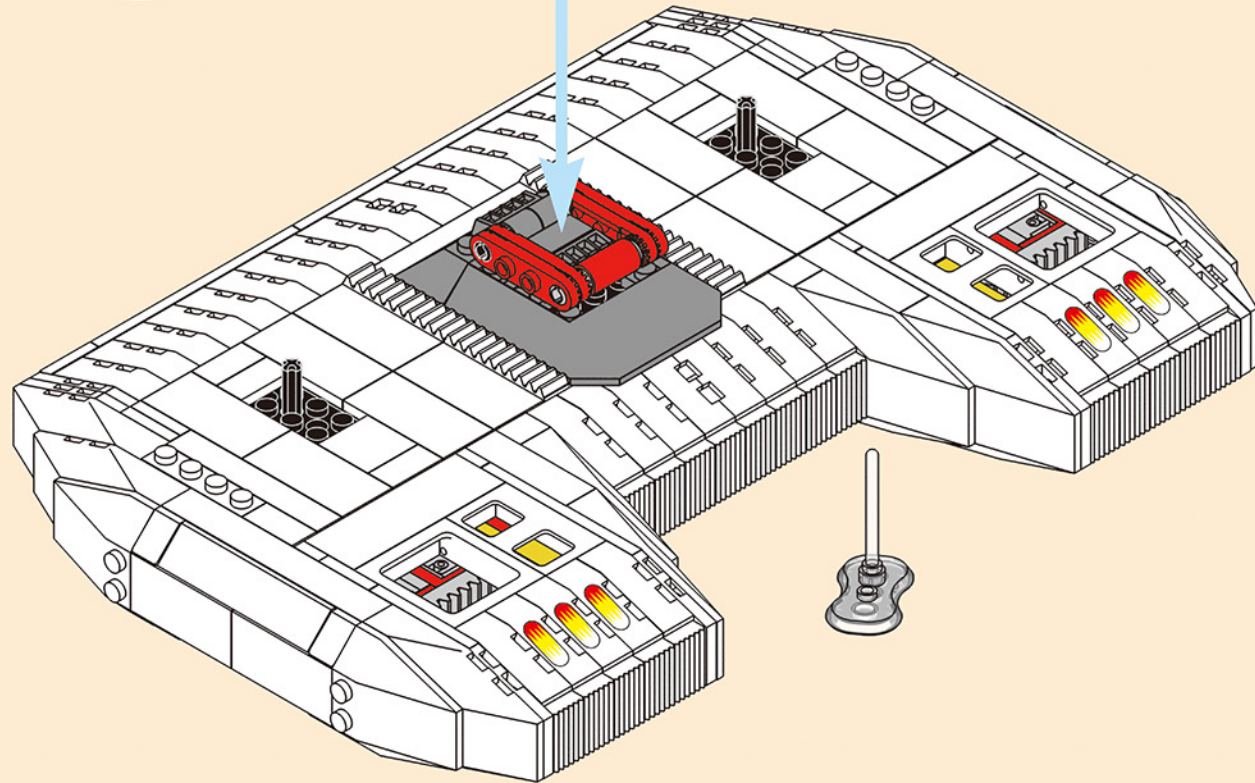

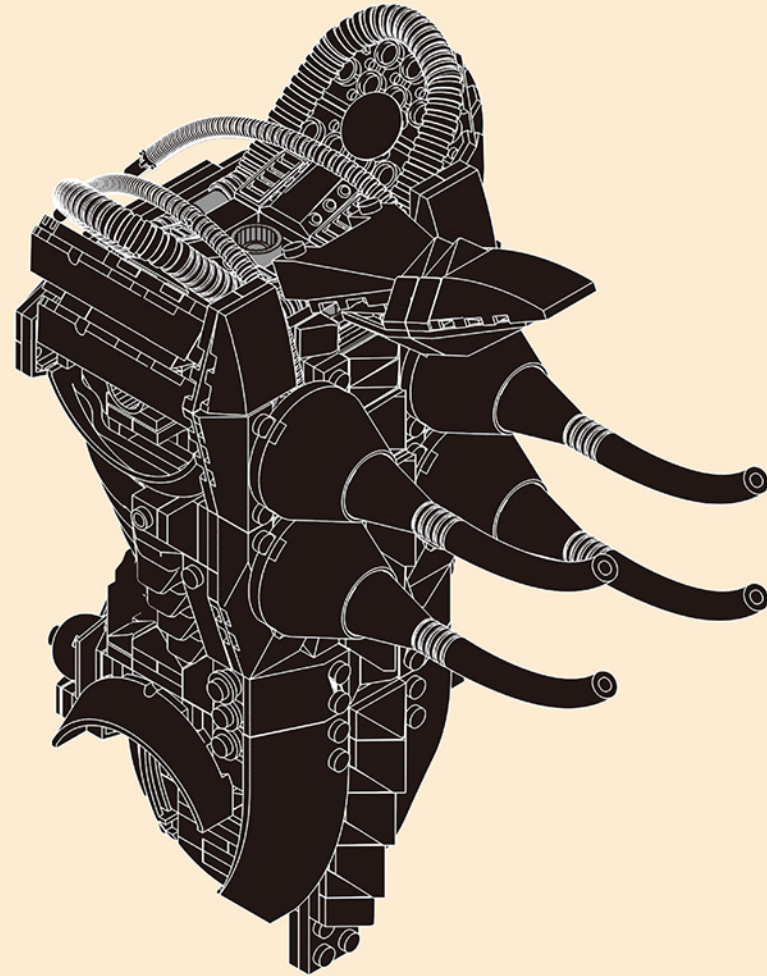

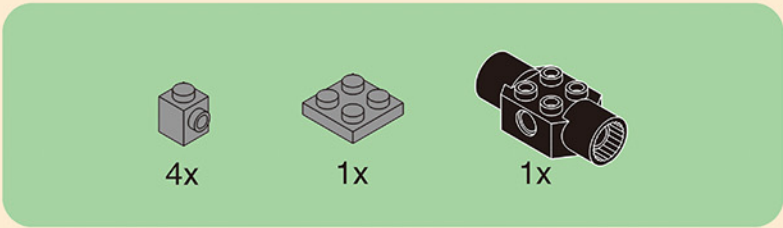

3-1

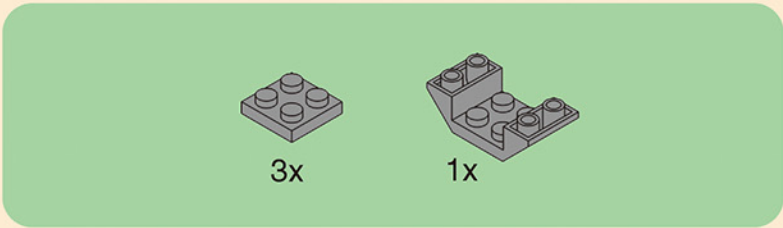
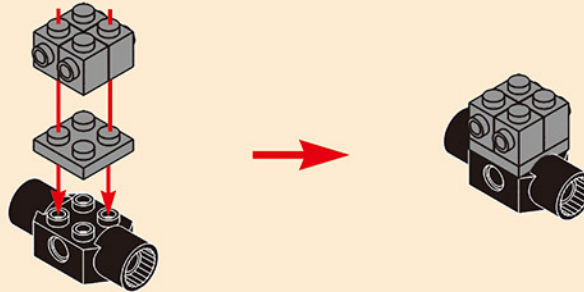

3-2

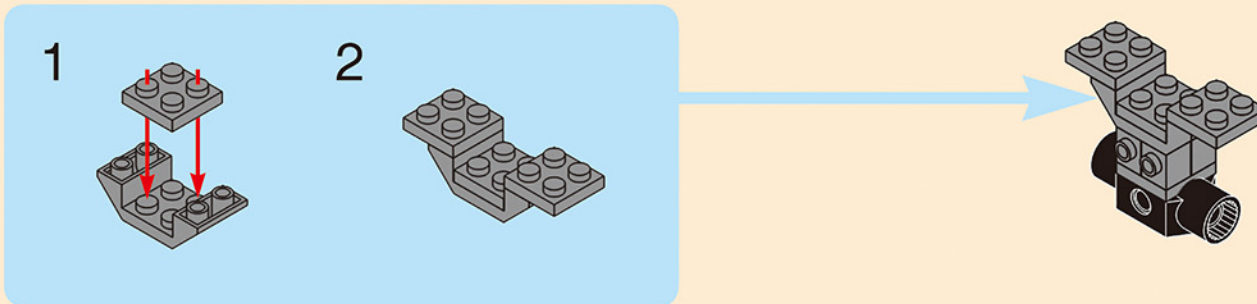

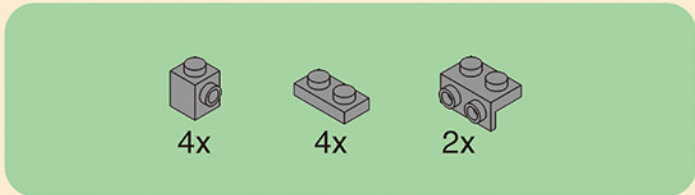

3-3

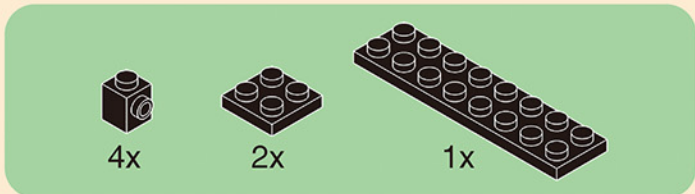
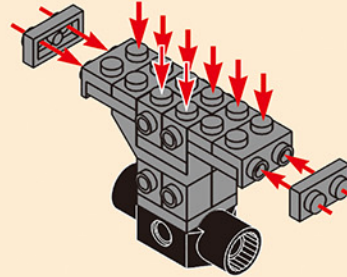

3-4

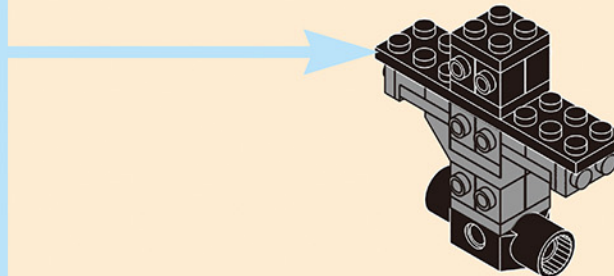
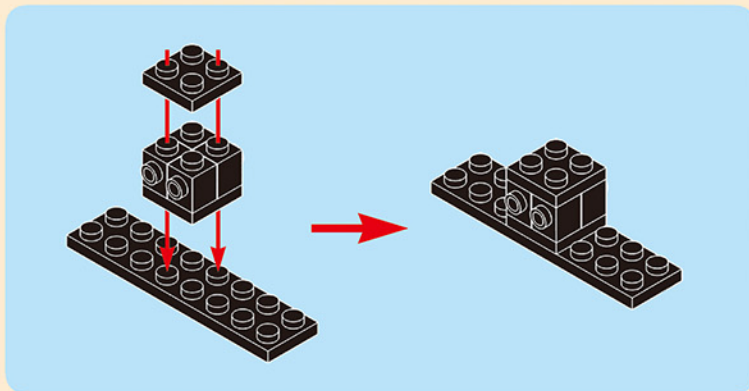

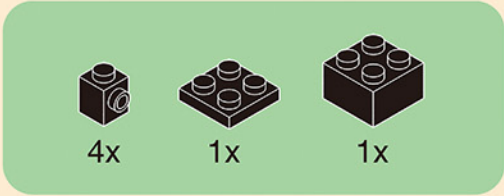

3-5

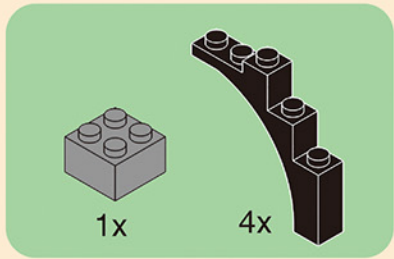
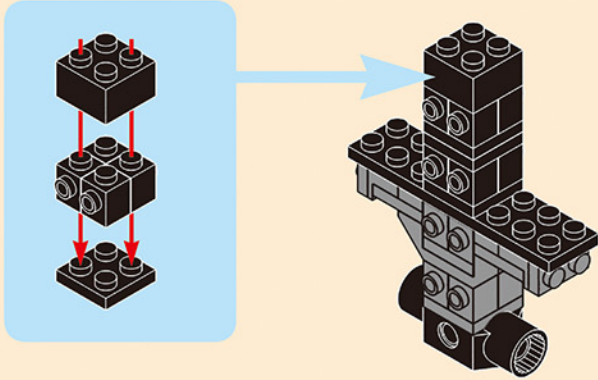

3-6

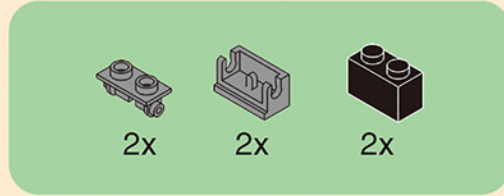
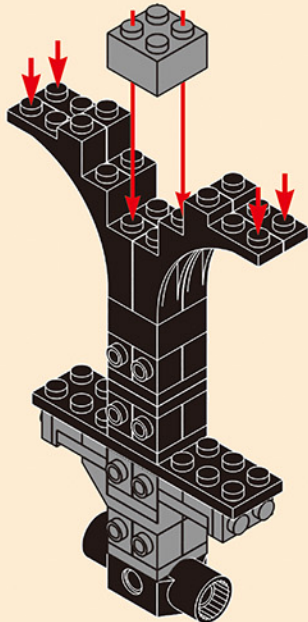

3-7

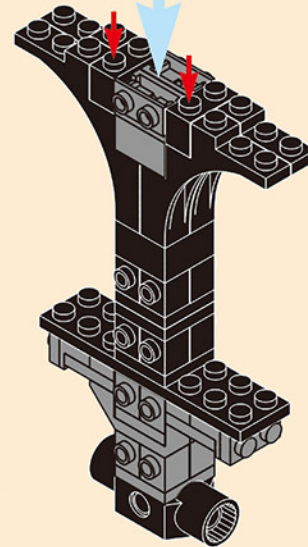
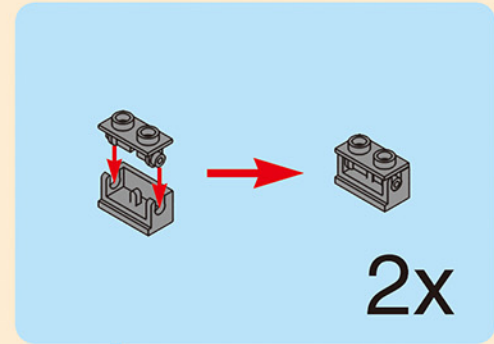

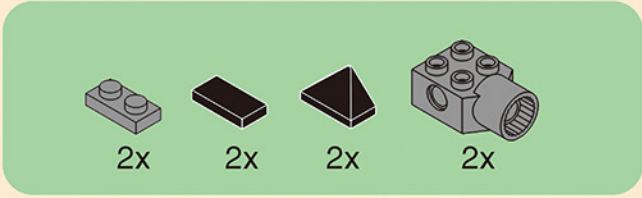

3-8

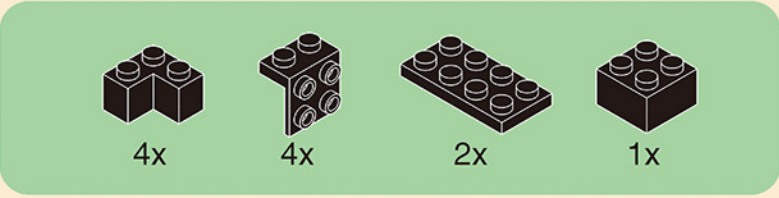
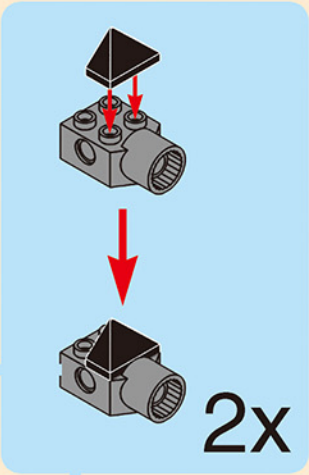

3-9

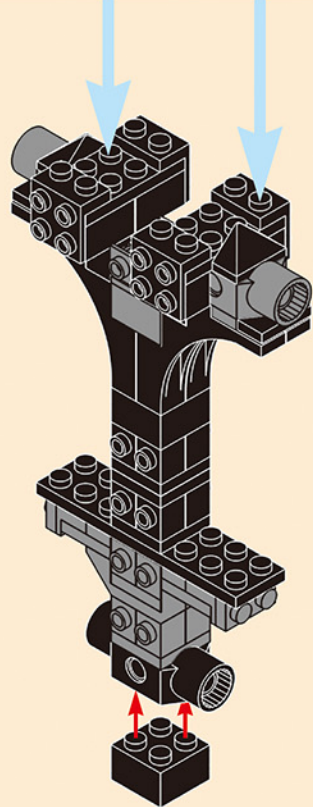
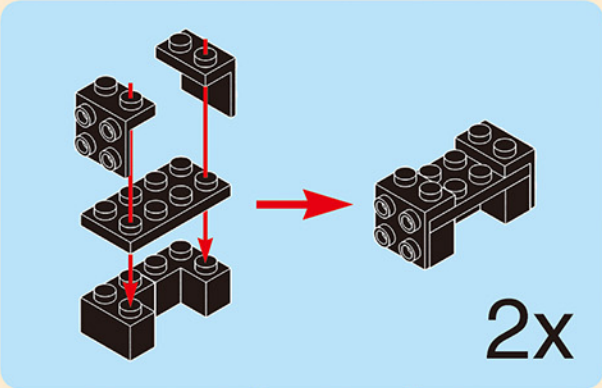

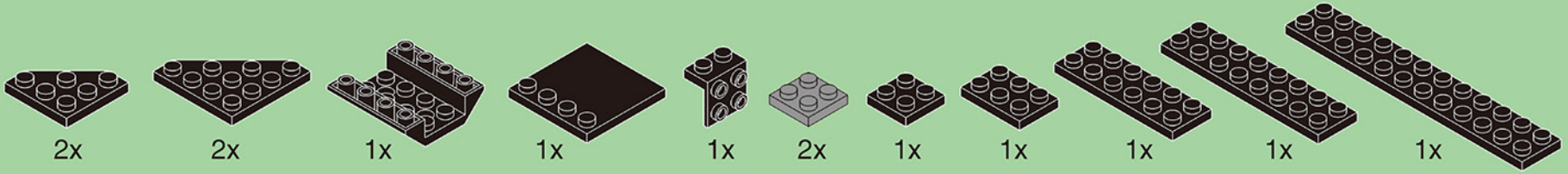

3-10.1

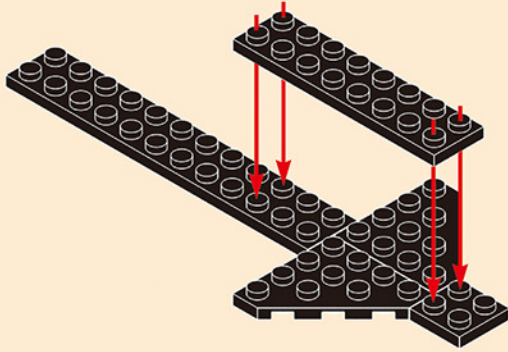

3-10.2

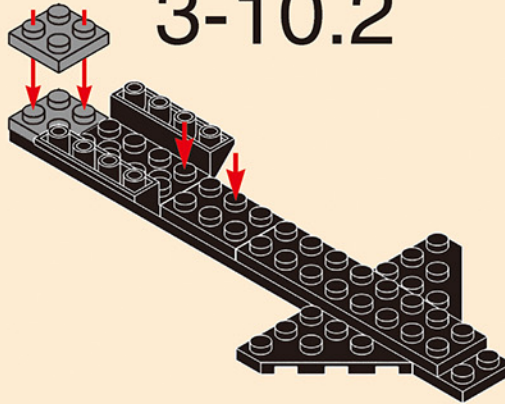

3-10.3

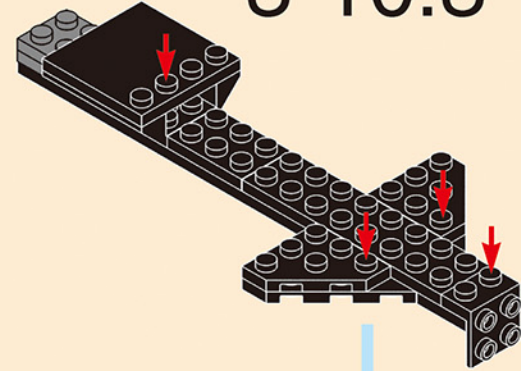

3-10

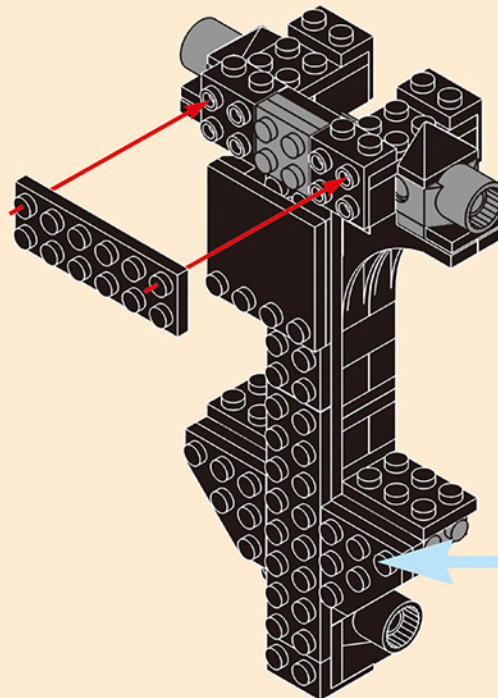

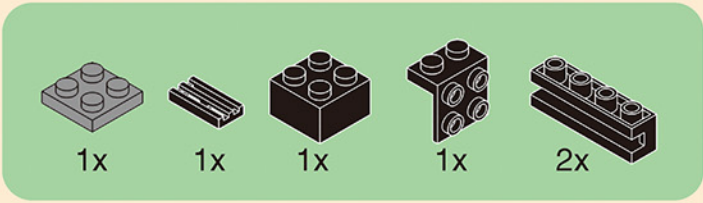

3-11.3

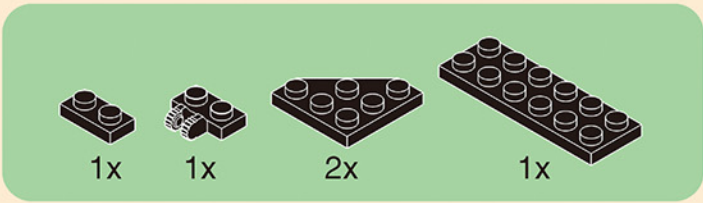
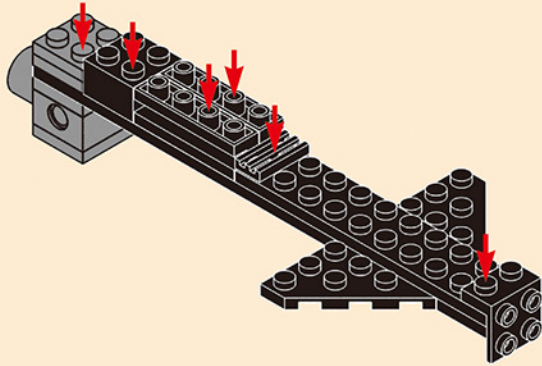

3-11.4

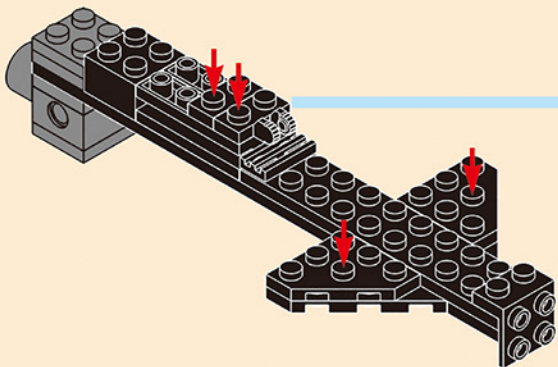

3-11

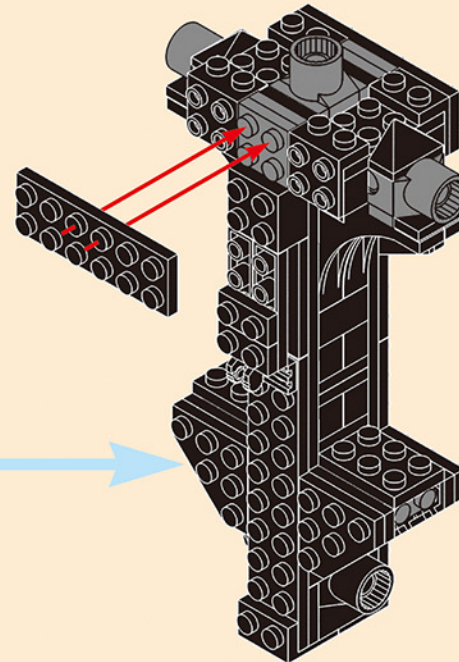

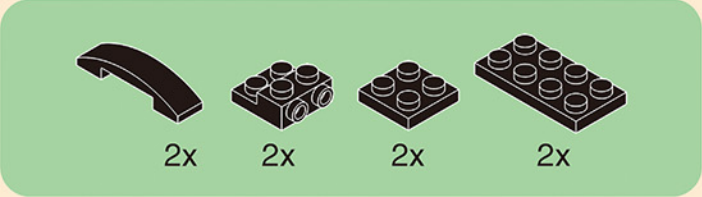

3-12

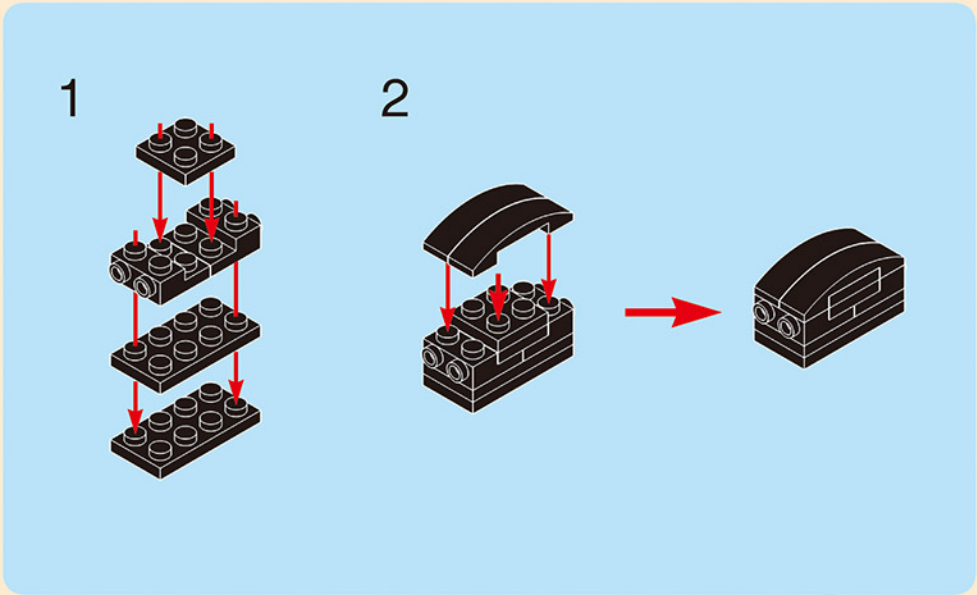

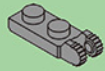

4x



2x

3-13

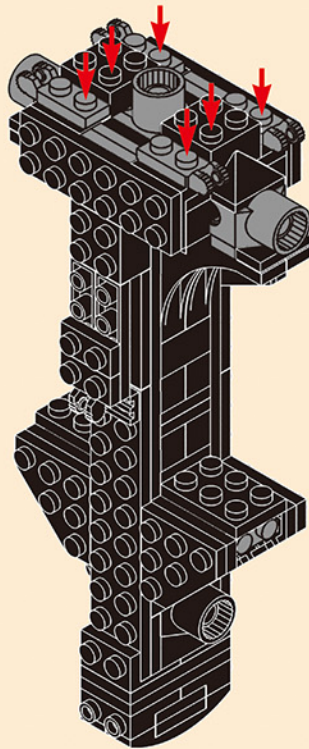

2x



4x

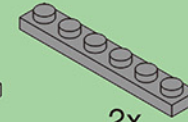

2x

3-14

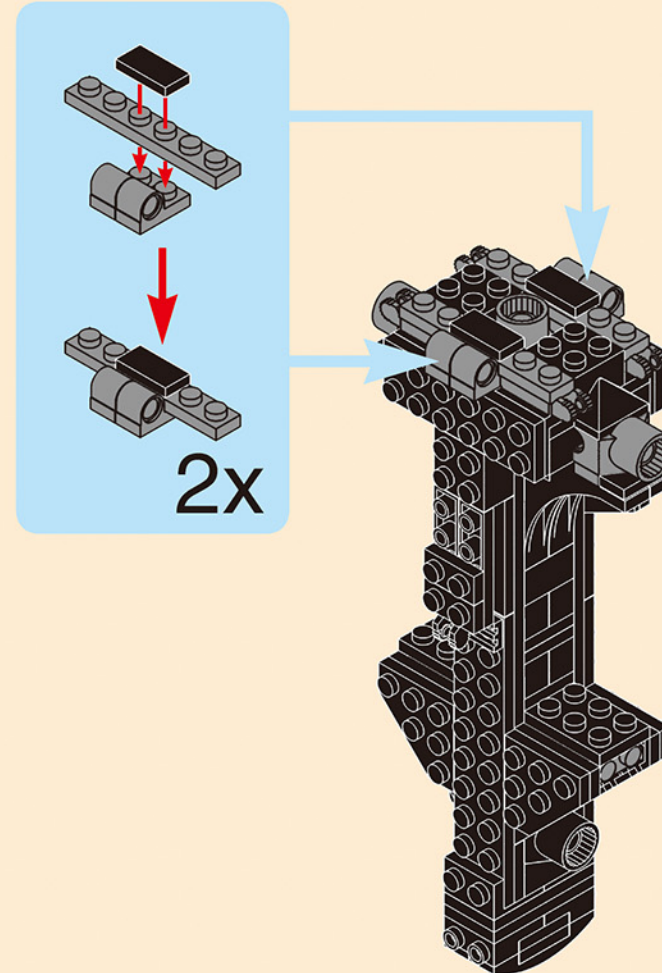

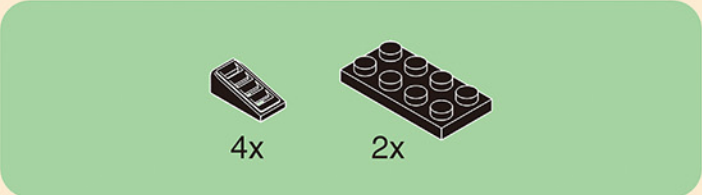

3-15

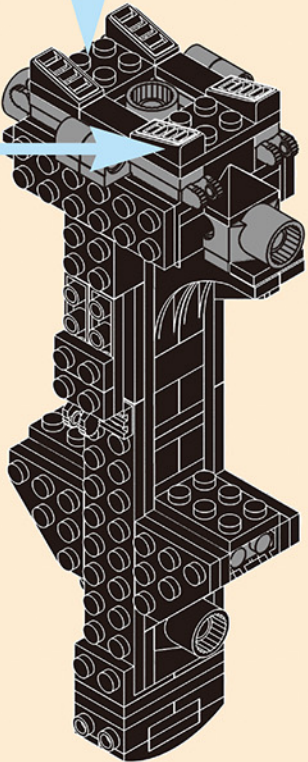
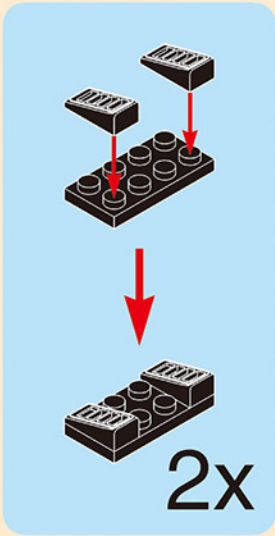

3-16.1

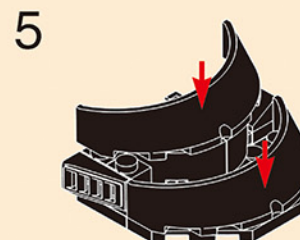
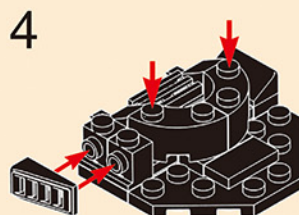
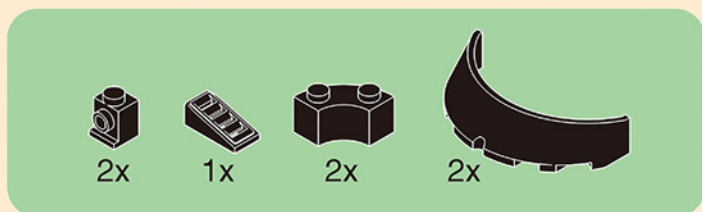
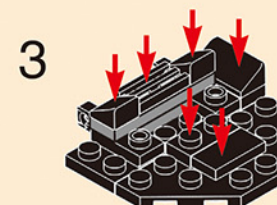
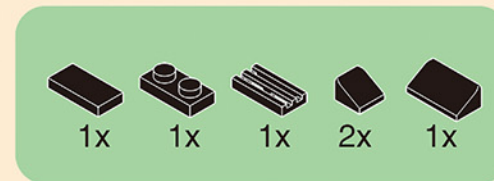
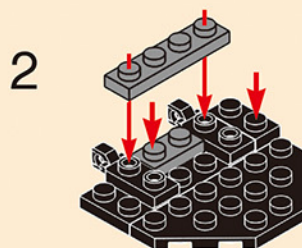
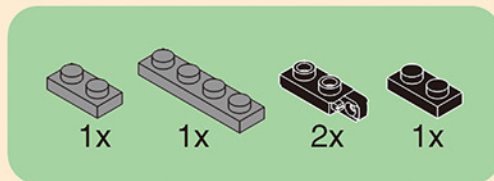
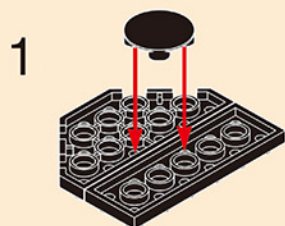
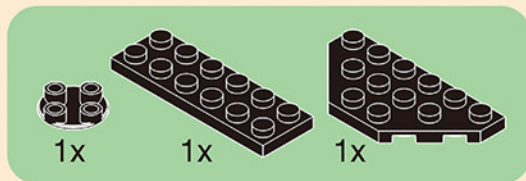

3-16.2

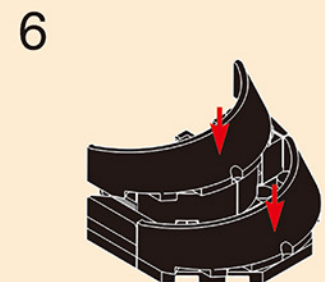
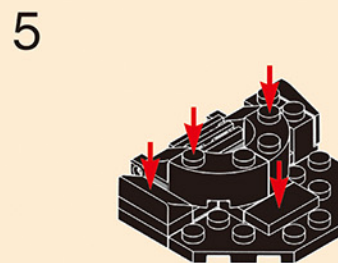
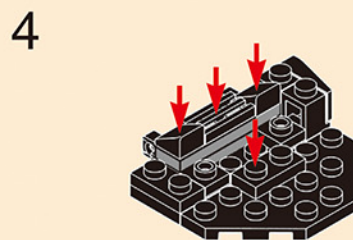
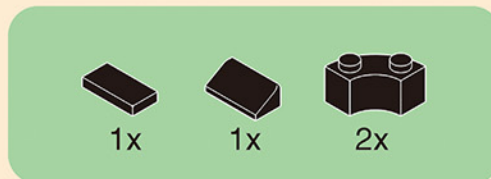
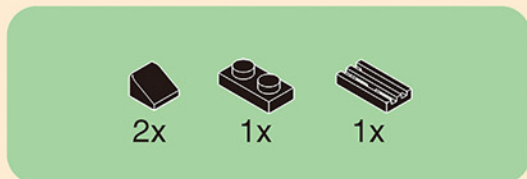
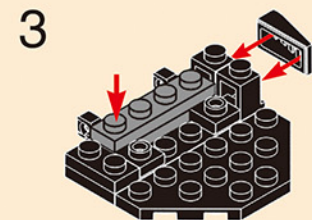
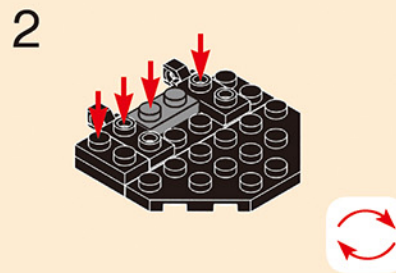
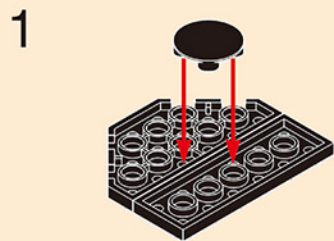
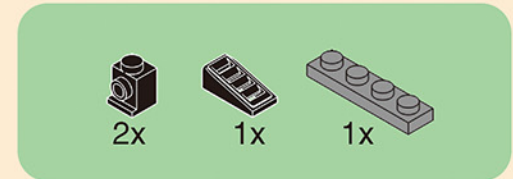
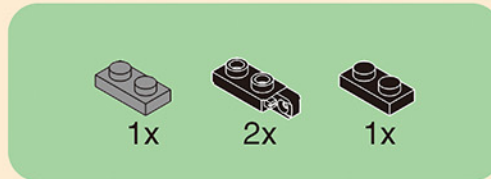
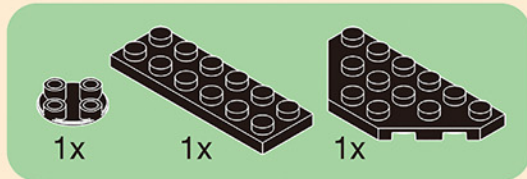

3-16

3-16.1

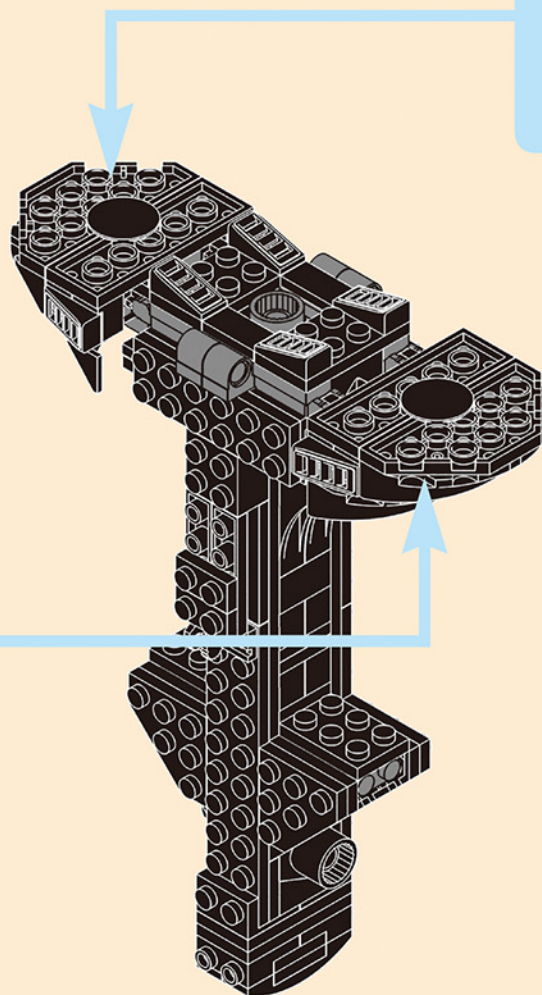

3-16.2

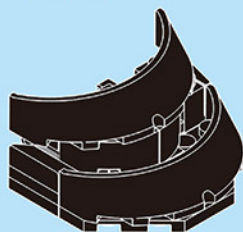

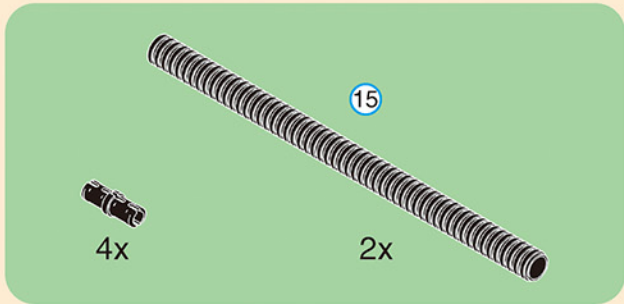
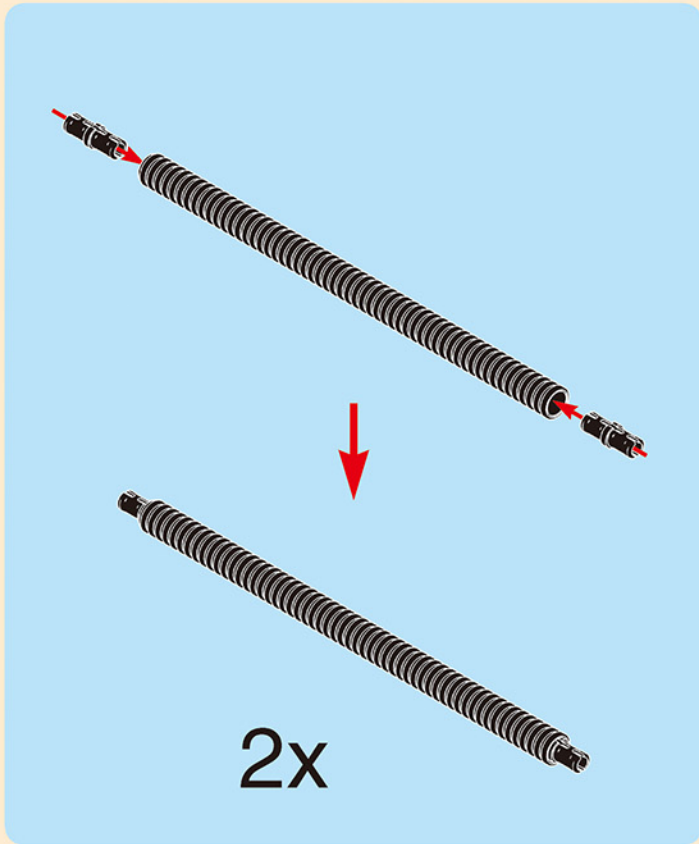

3-17

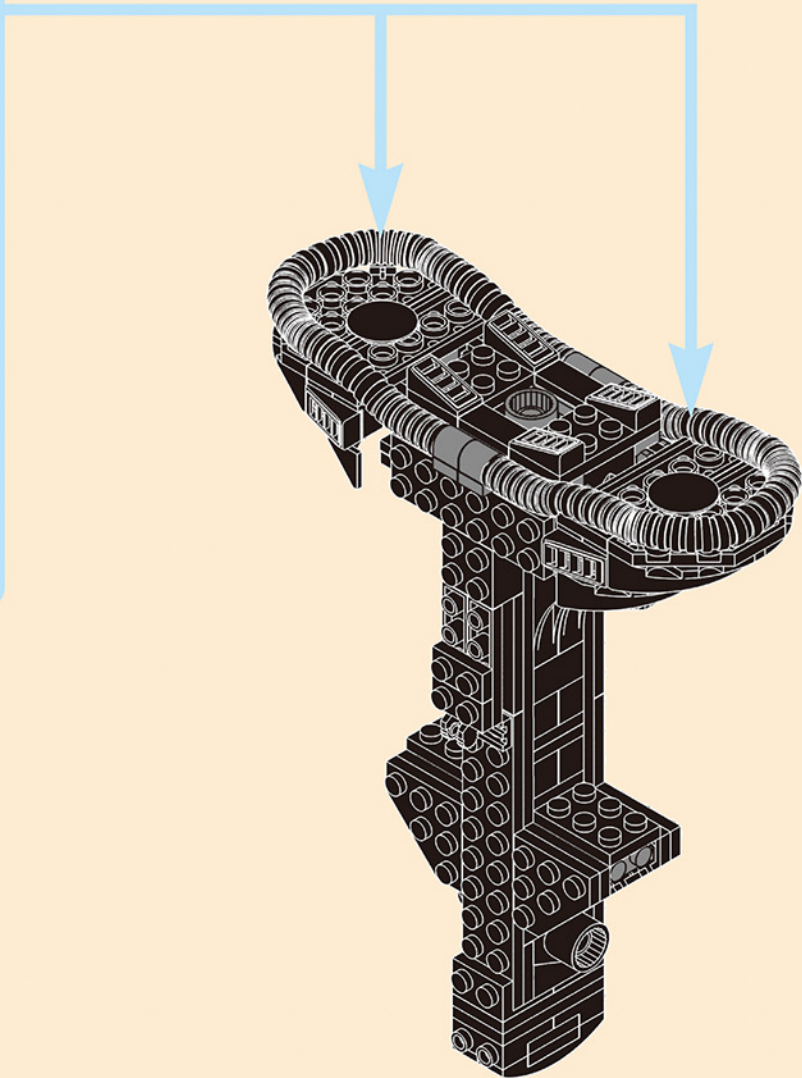

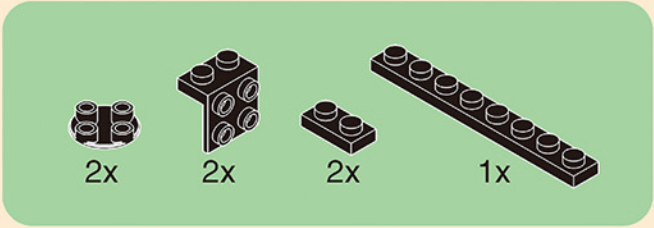

3-18.1

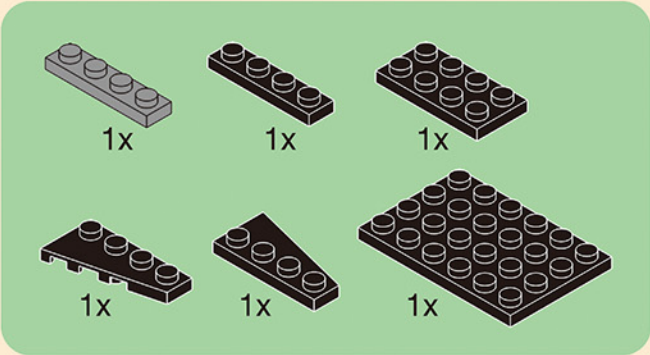
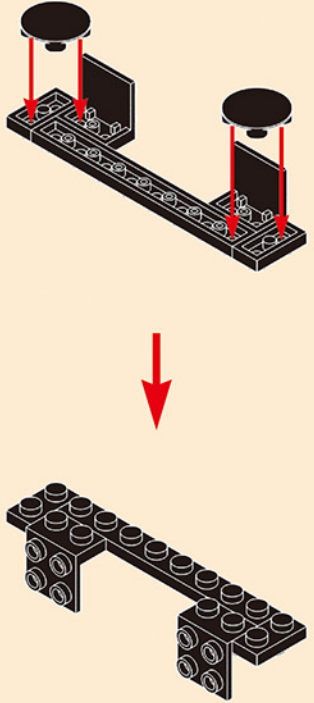

3-18.2

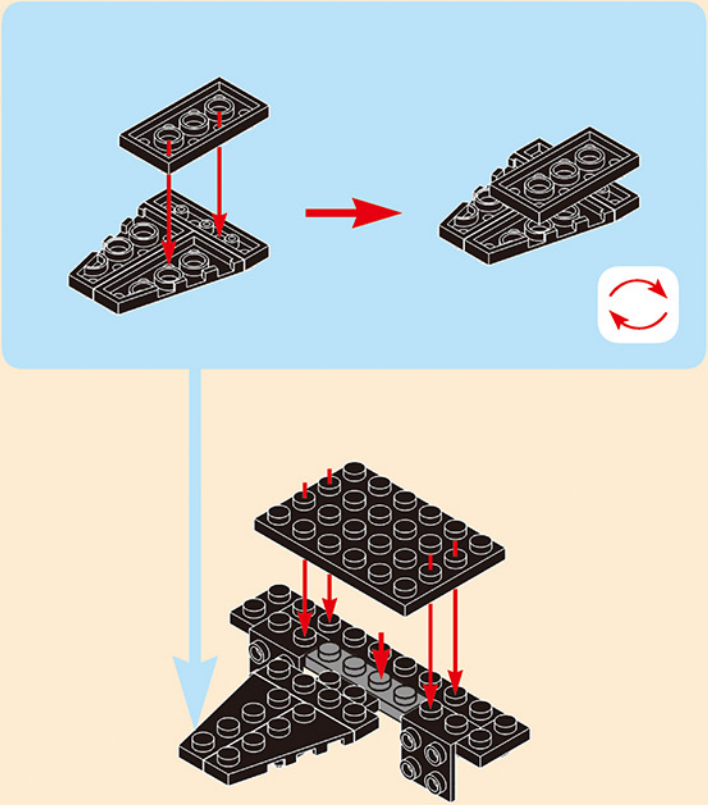

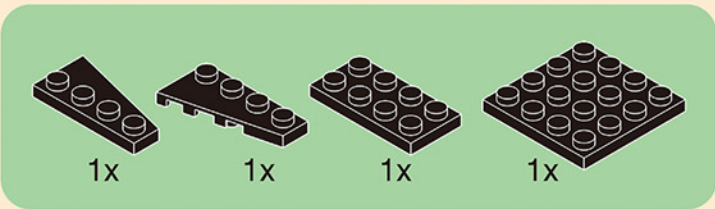

3-18.3

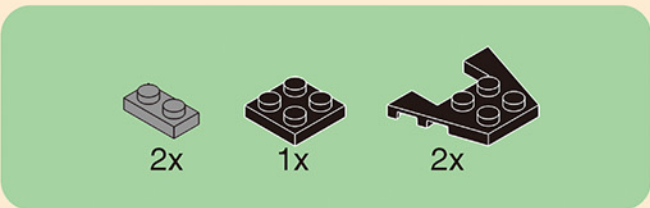
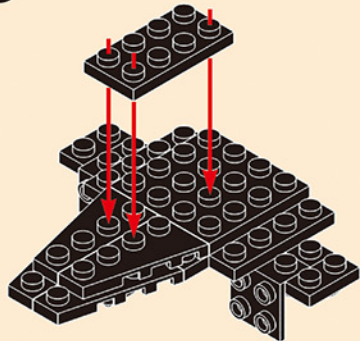

3-18.4

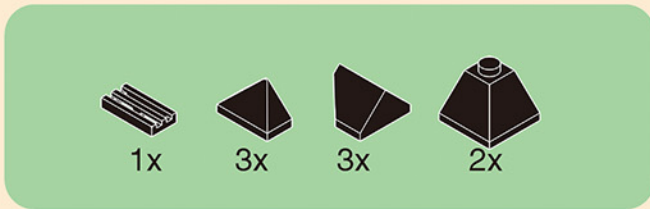
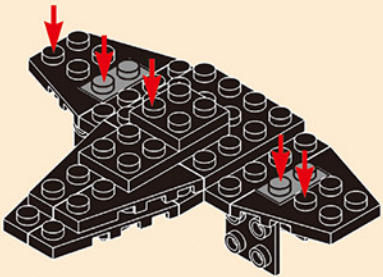

3-18.5

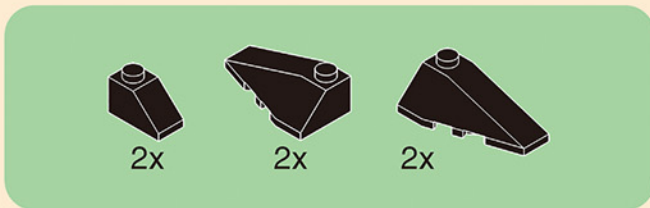
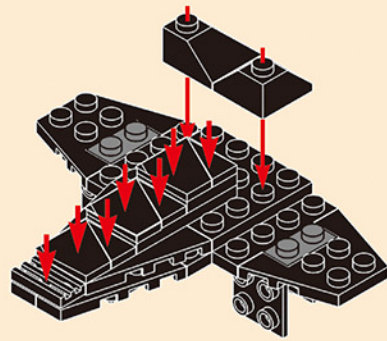

3-18.6

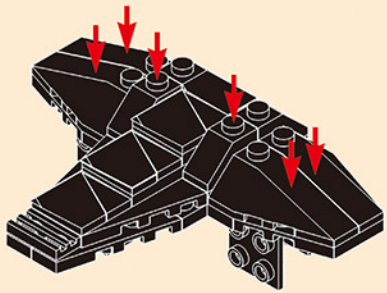



4x



6x



2x

3-18.7

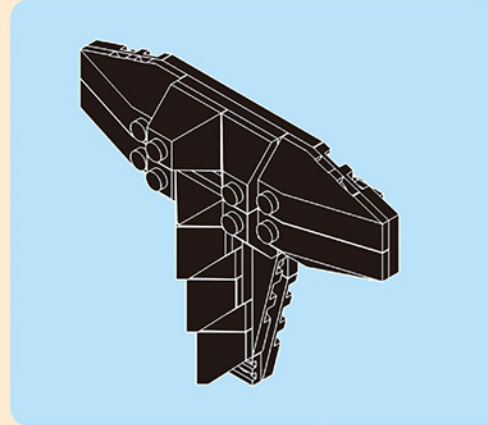
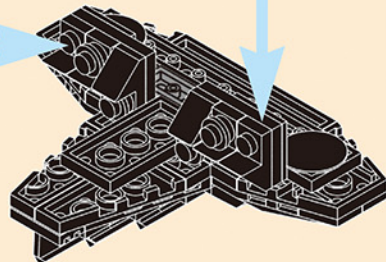
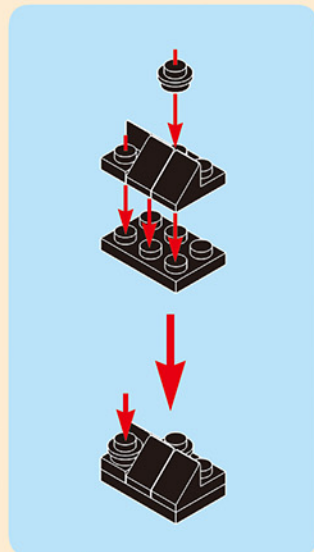
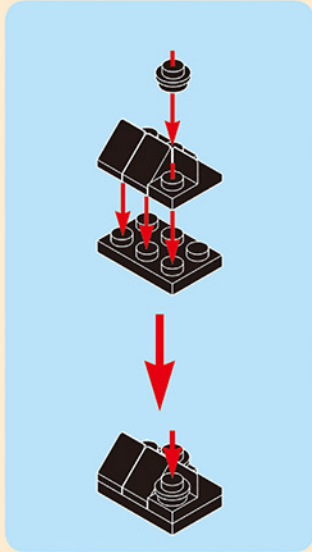

3-18

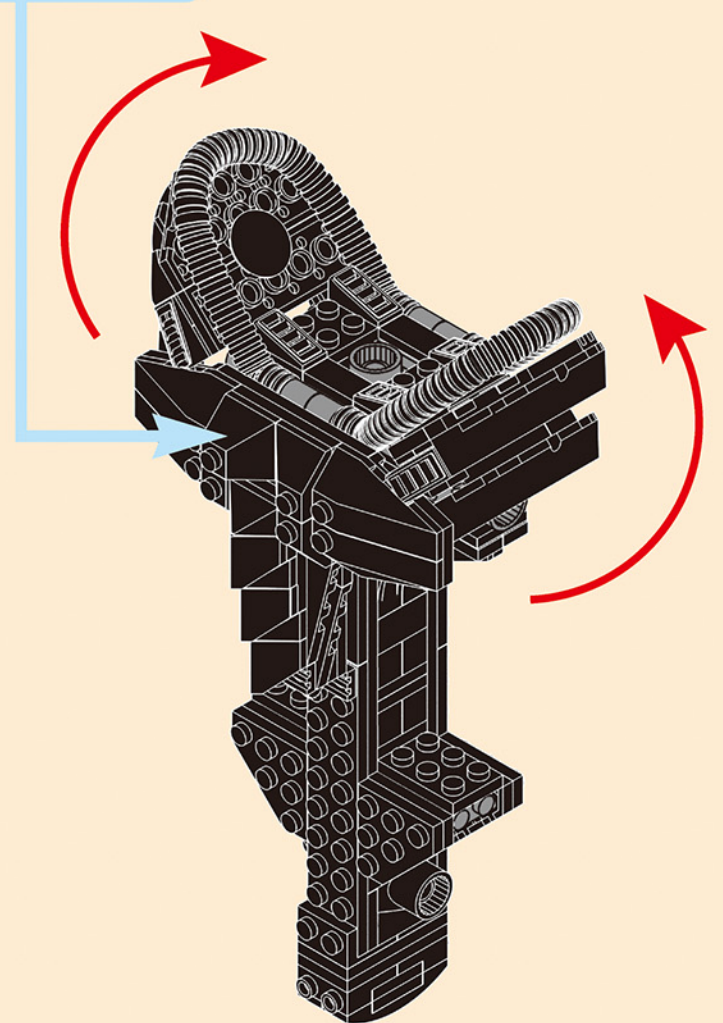

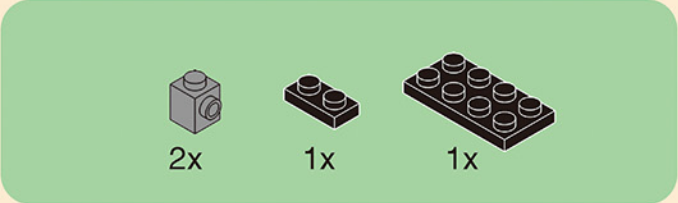

3-19

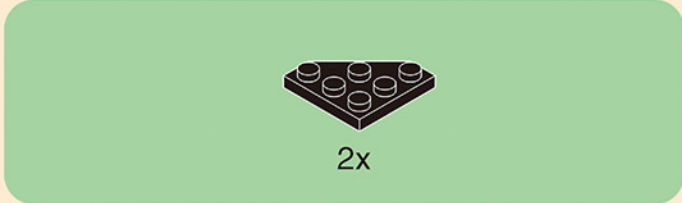
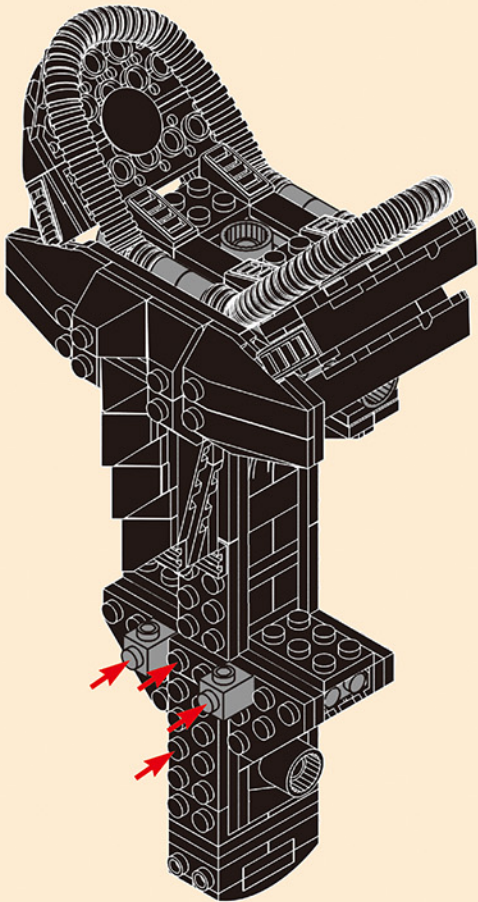

3-20

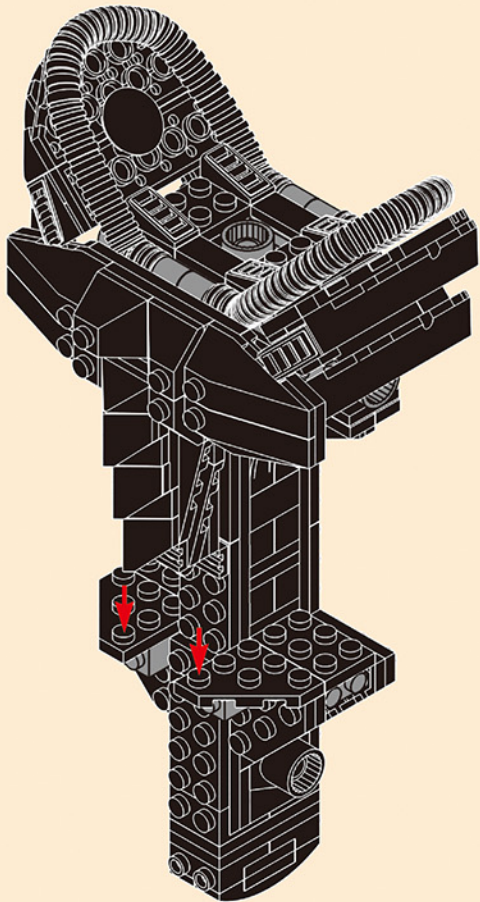



3-21

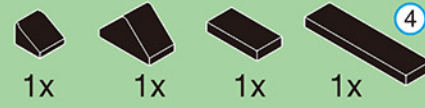
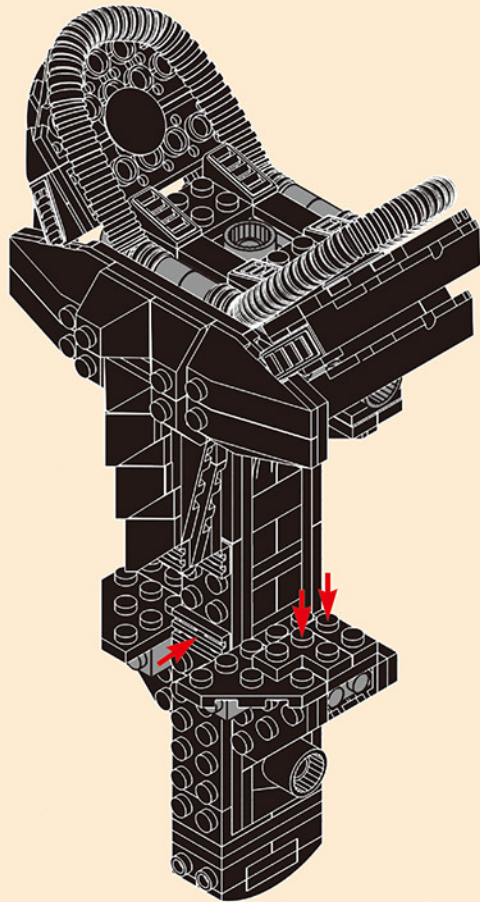

3-22

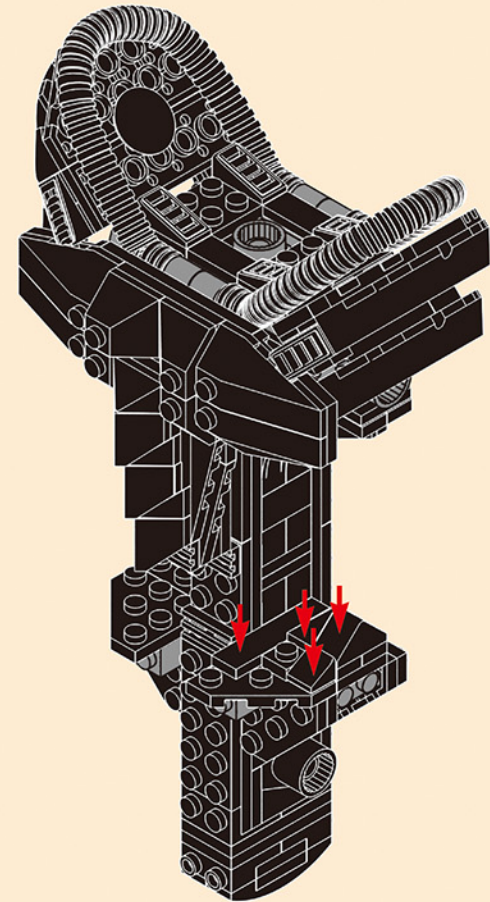

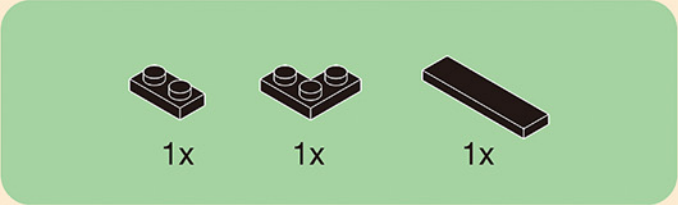

3-23

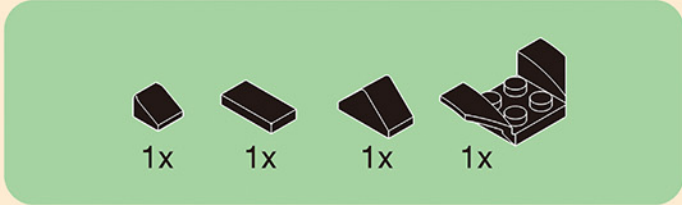
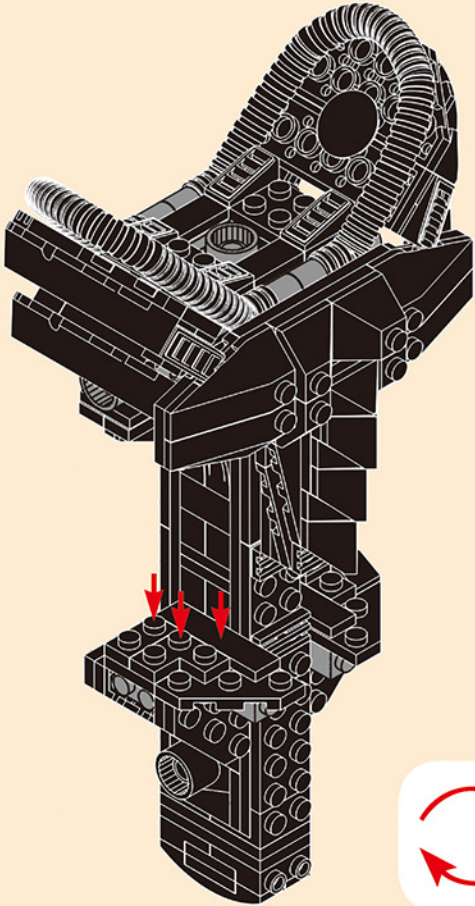

3-24

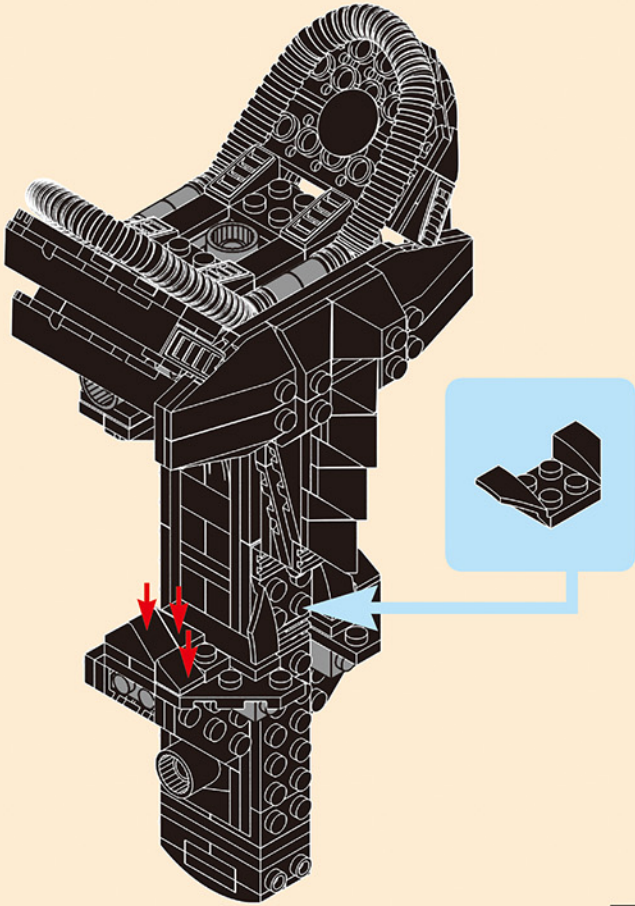

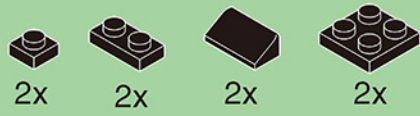

3-25

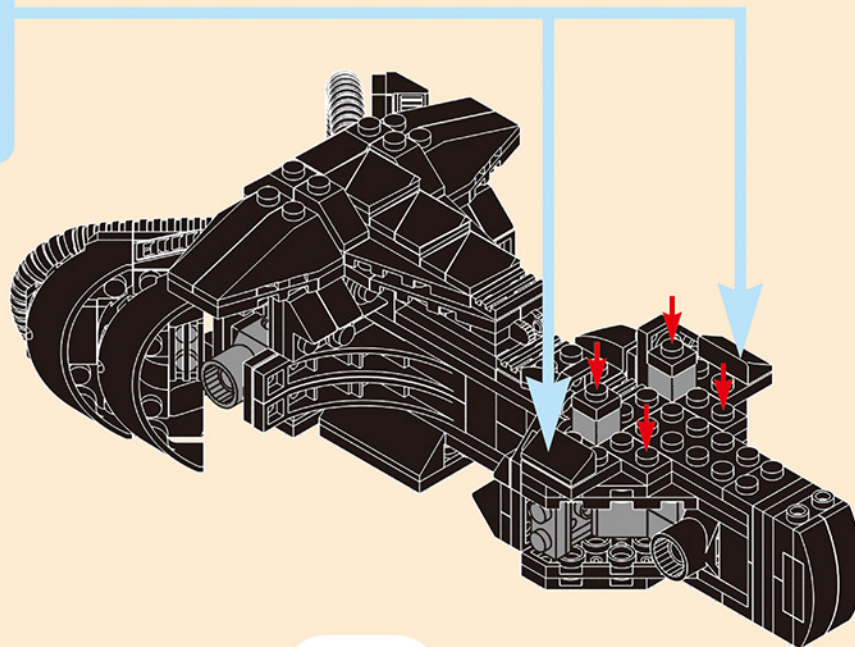
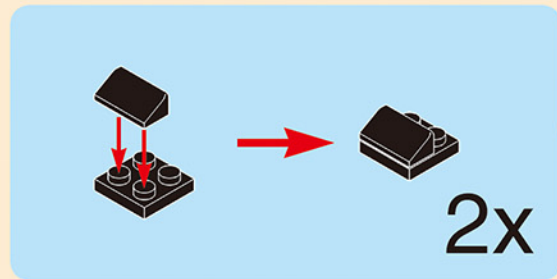

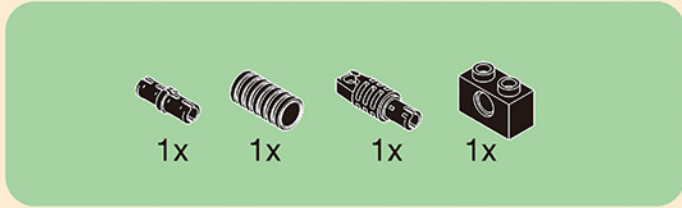

3-26

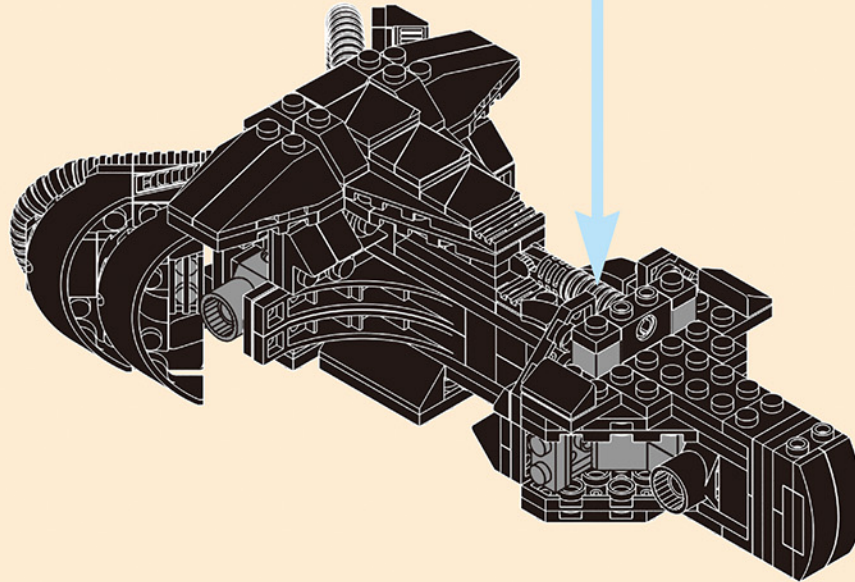
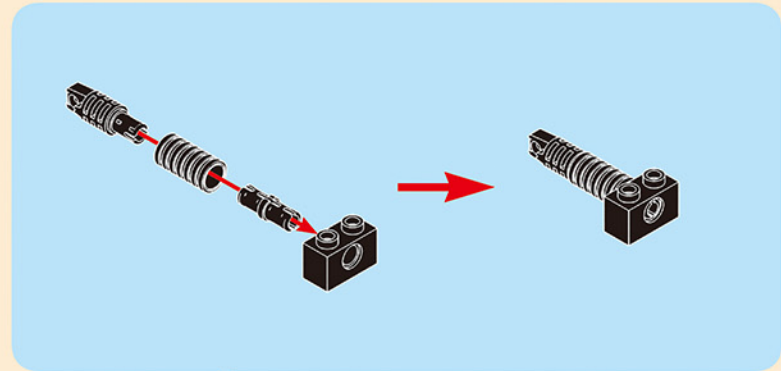

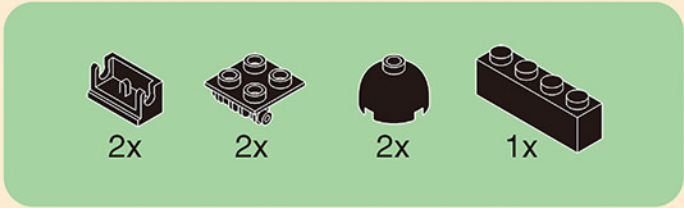

3-27

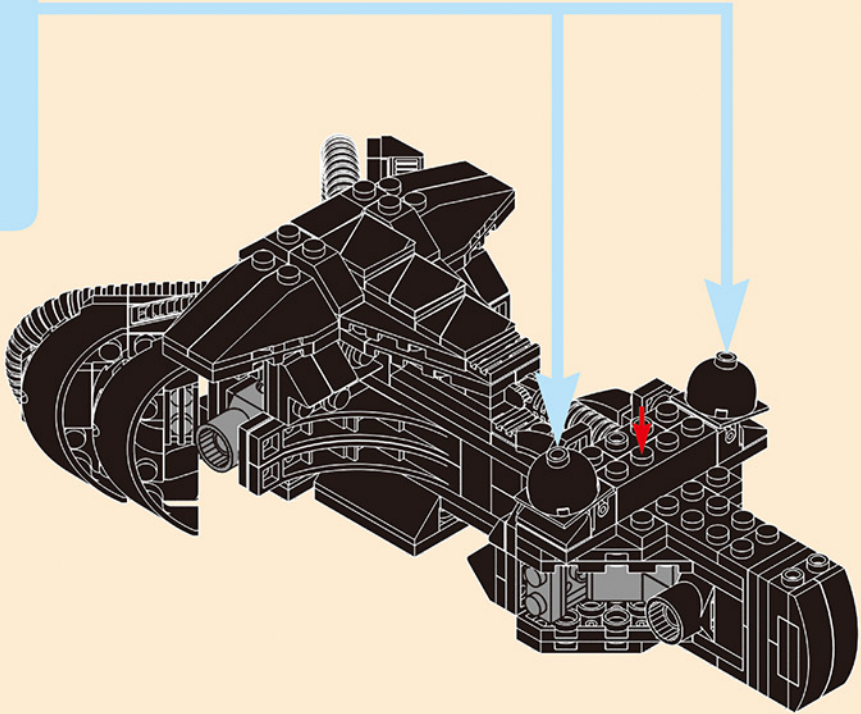
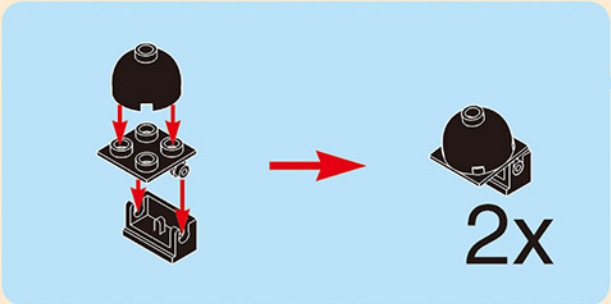

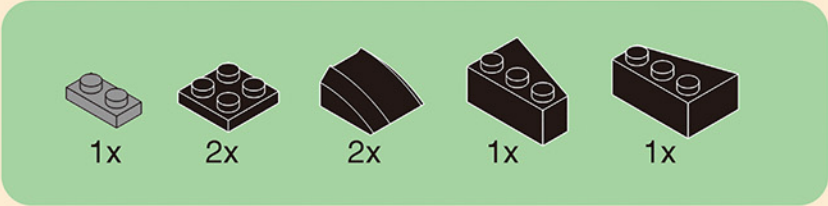

3-28

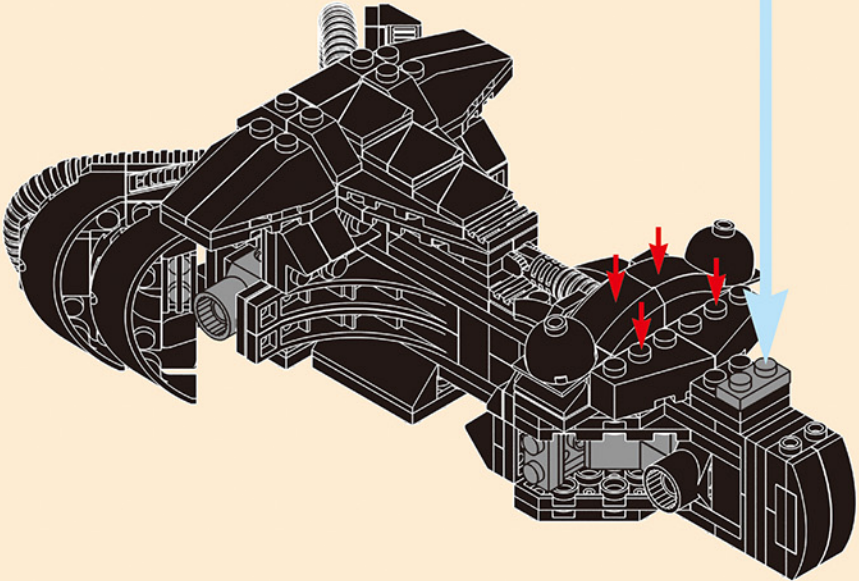
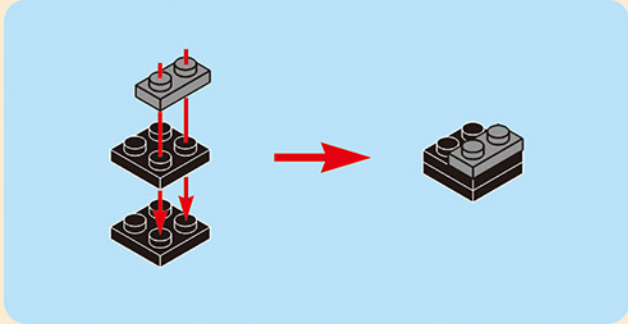

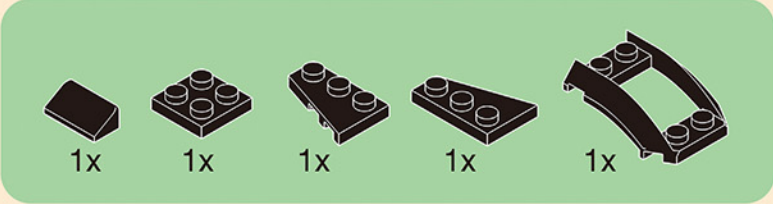

3-29

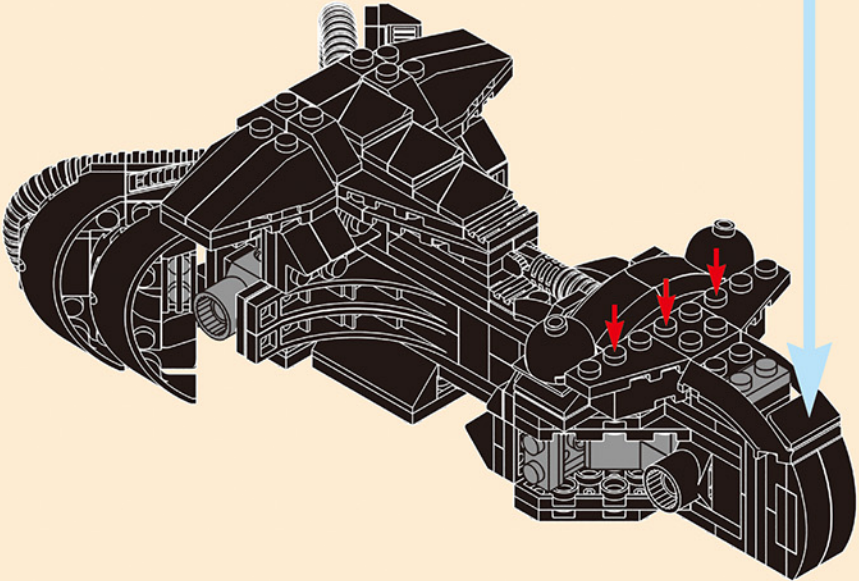
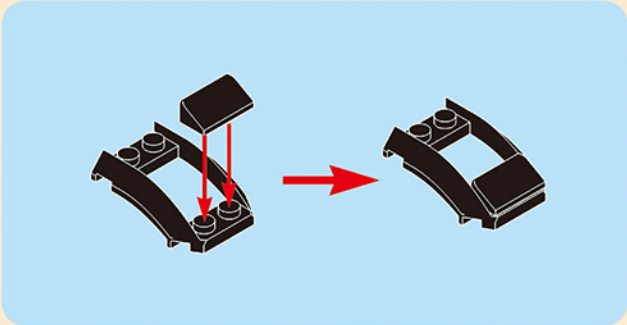

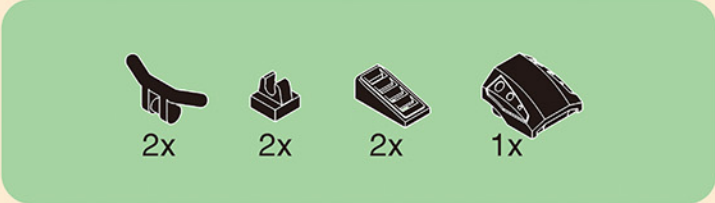

3-30

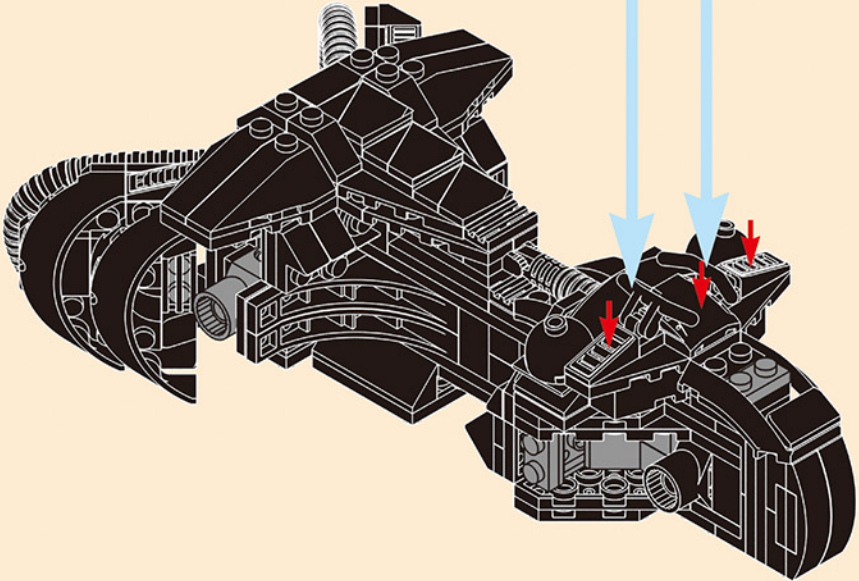
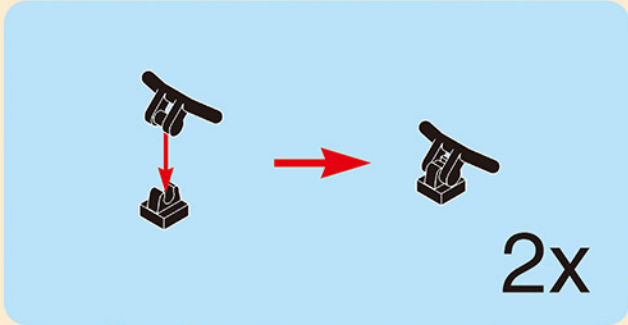

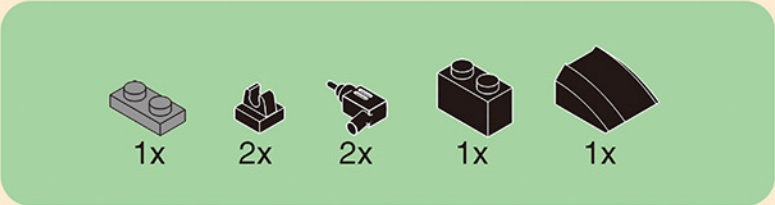

3-31

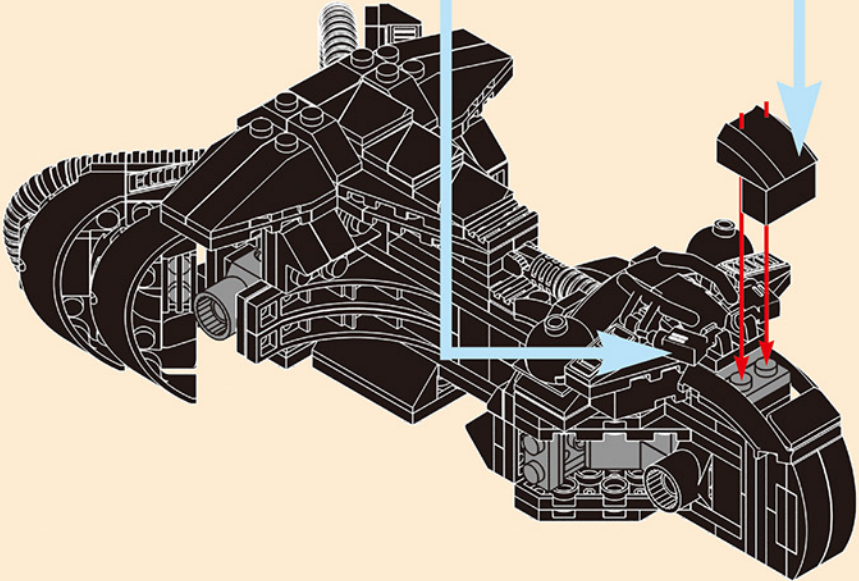
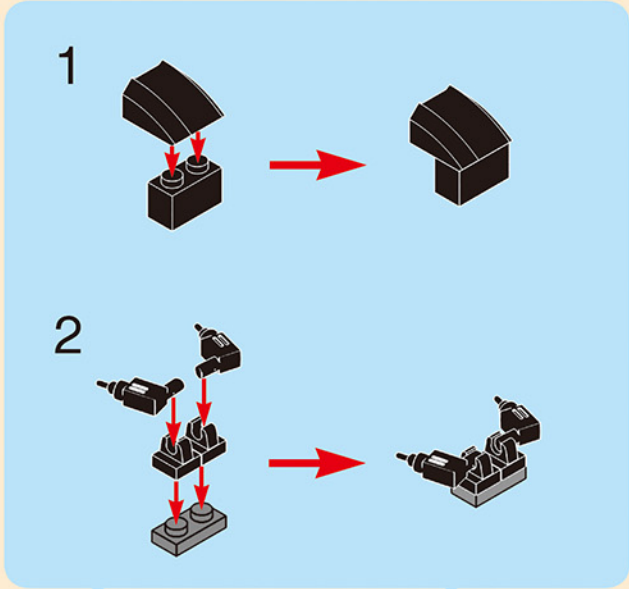

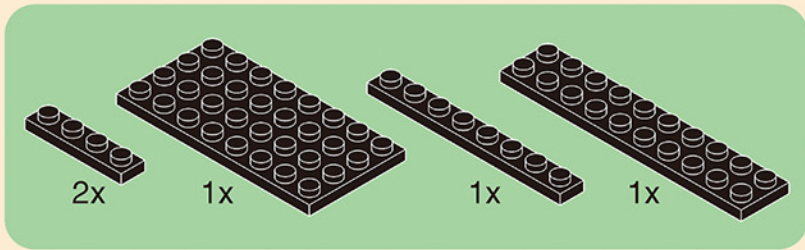

3-32.1

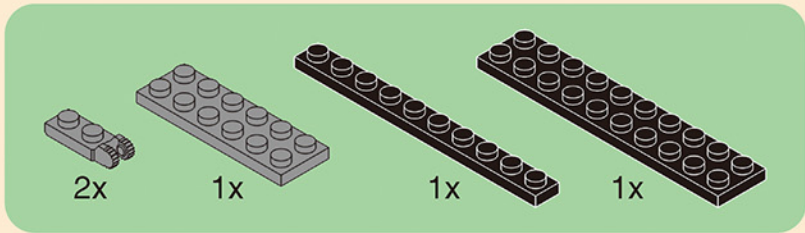
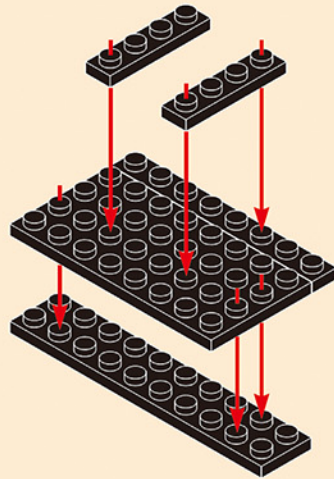

3-32.2

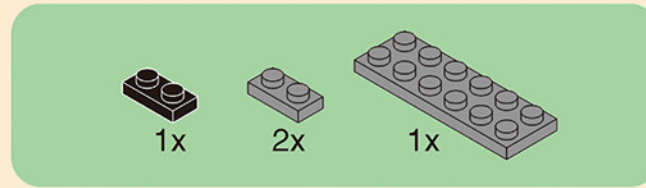
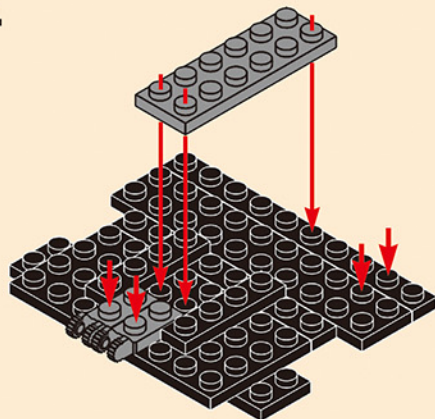

3-32.3

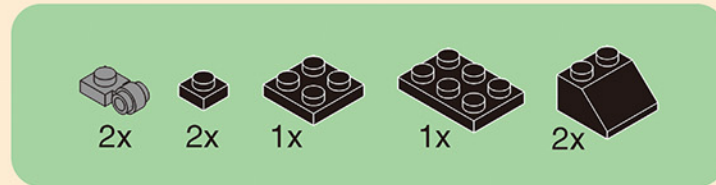
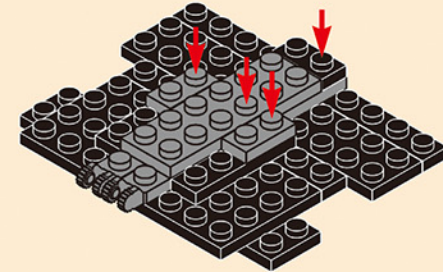

3-32.4

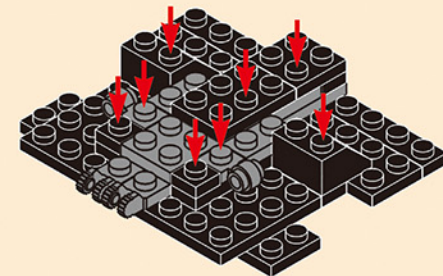

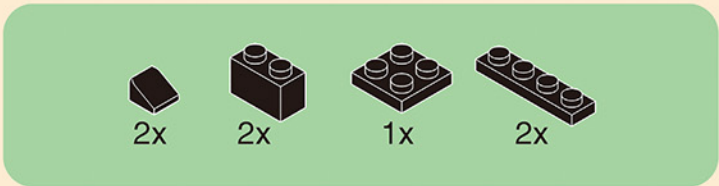

3-32.5

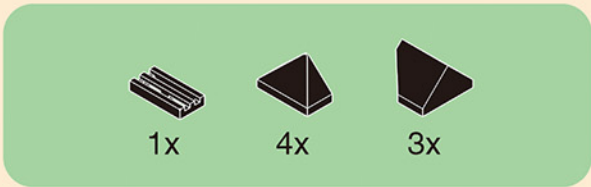
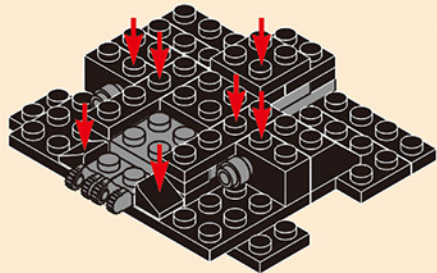

3-32.6

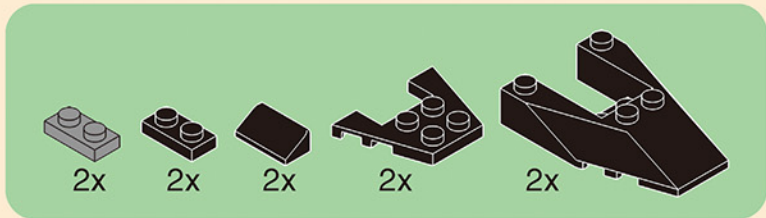
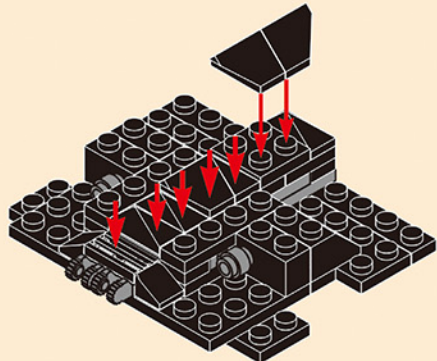

3-32.7

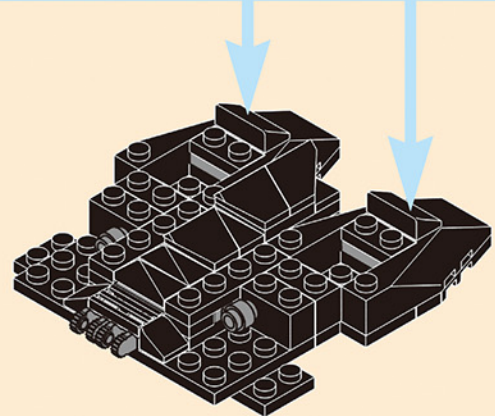
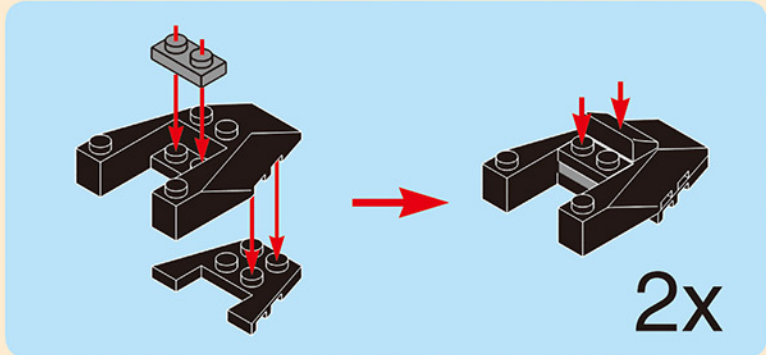

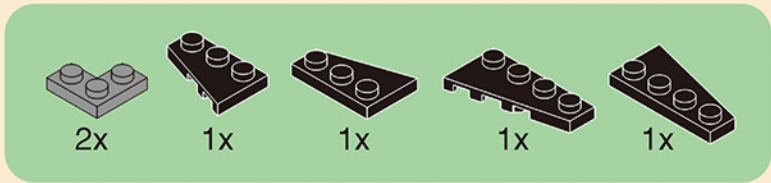

3-32.8

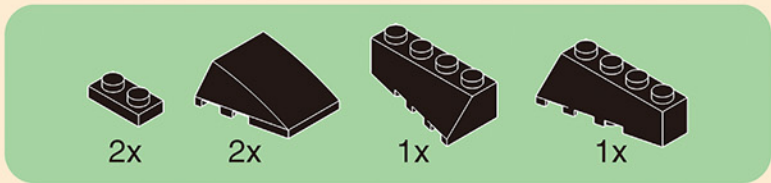
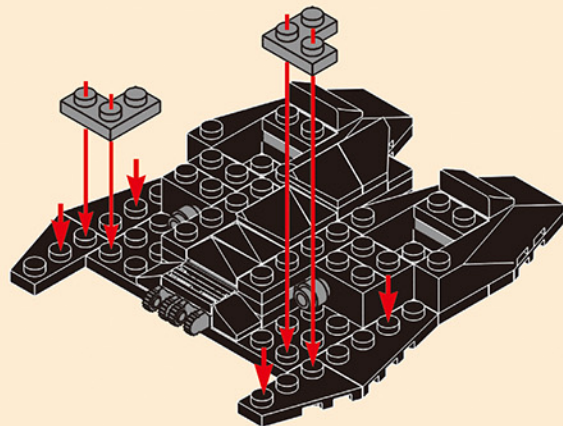

3-32.9

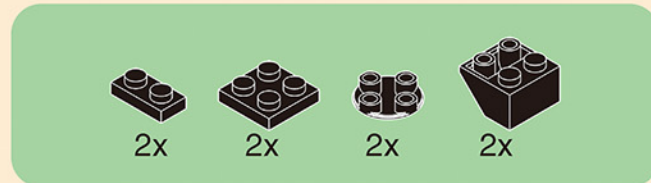
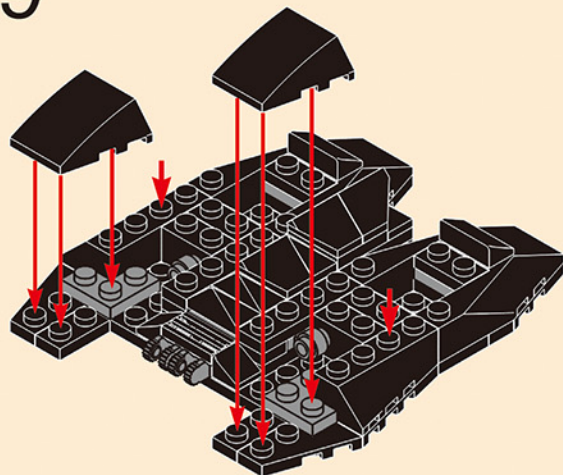

3-32.10

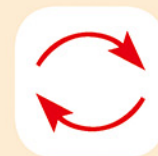
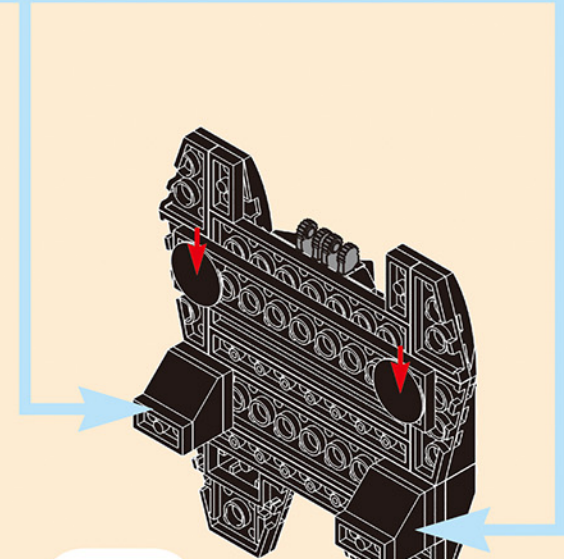
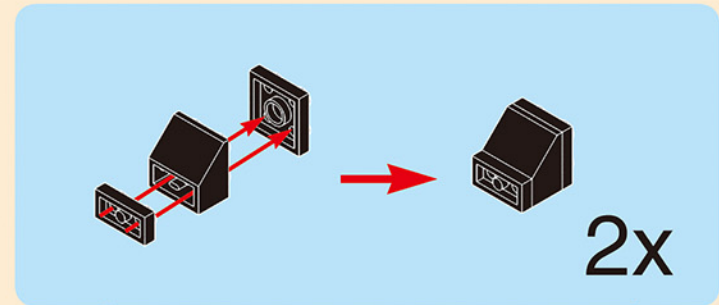

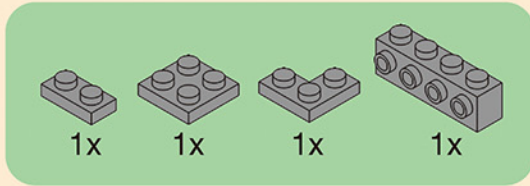

3-32.11.1

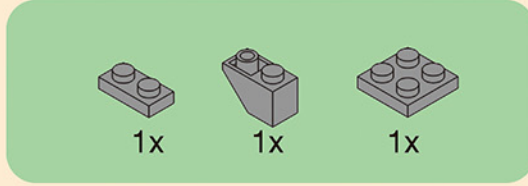
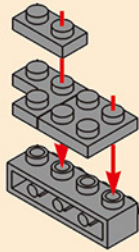

3-32.11.2

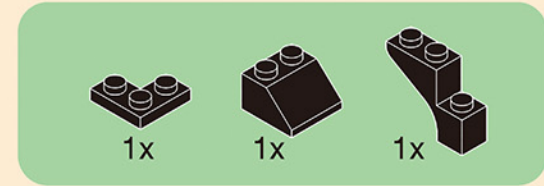
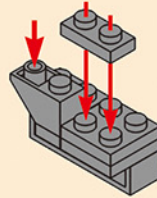

3-32.11.3

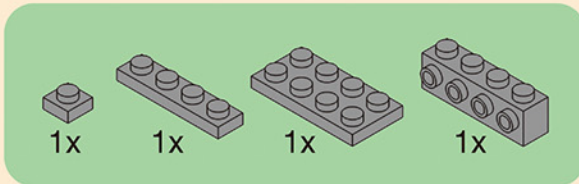
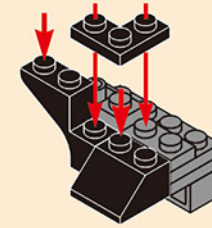

3-32.11.4

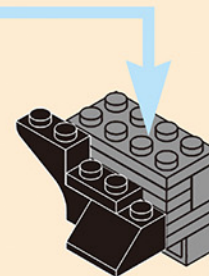
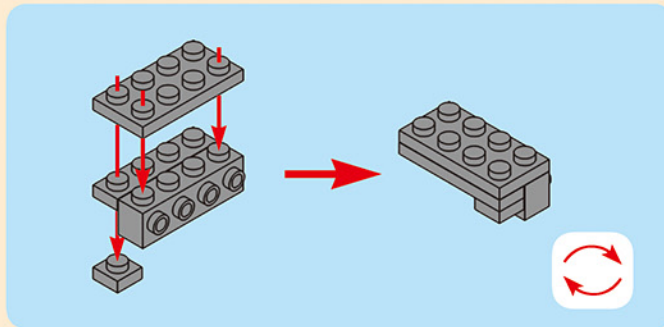

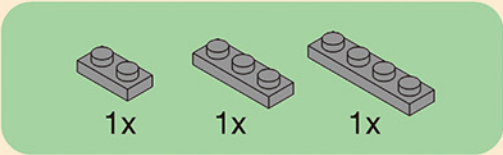

3-32.11.5

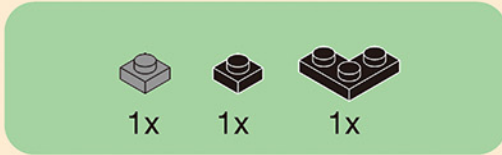
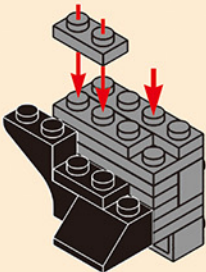

3-32.11.6

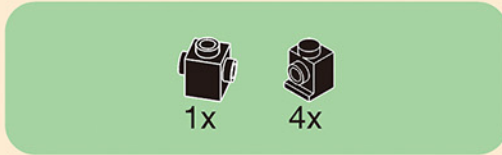
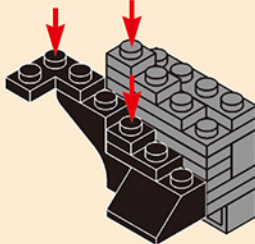

3-32.11.7

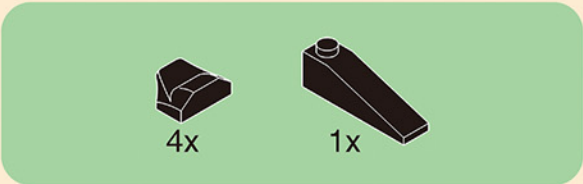
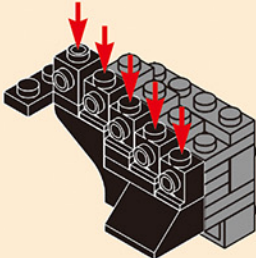

3-32.11.8

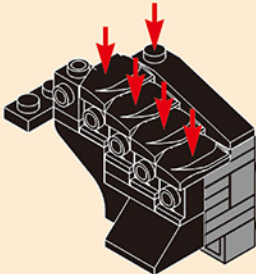

3-32.11

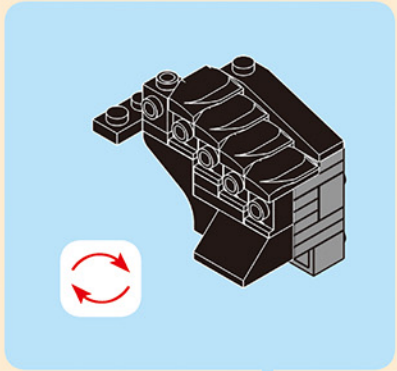
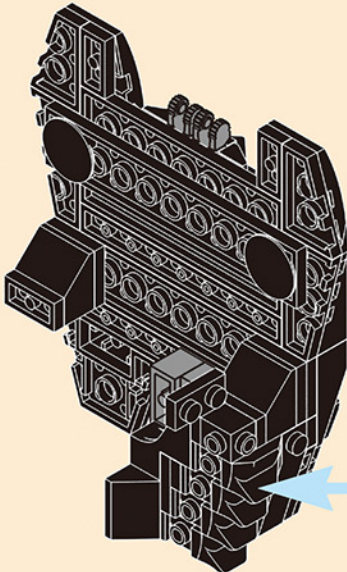

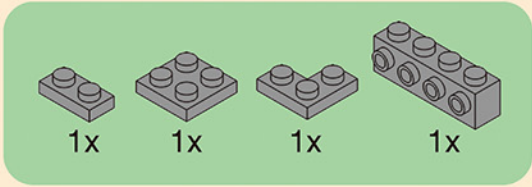

3-32.12.1

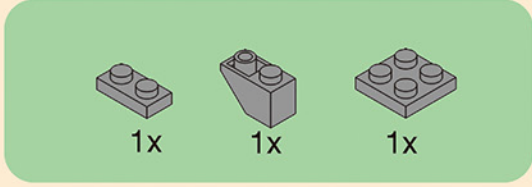
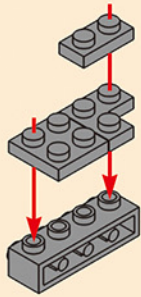

3-32.12.2

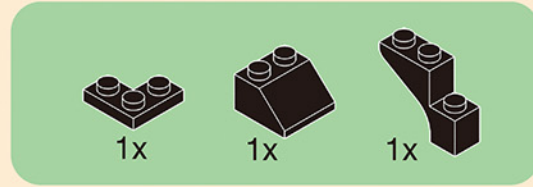
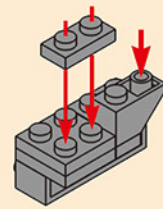

3-32.12.3

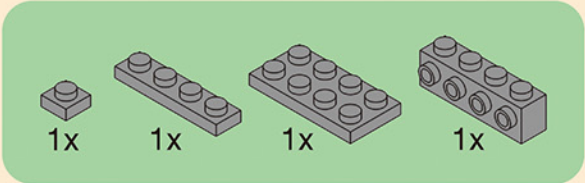
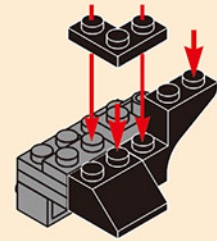

3-32.12.4

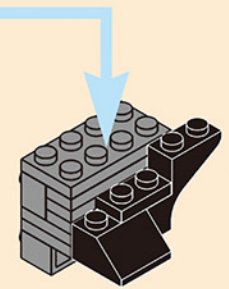
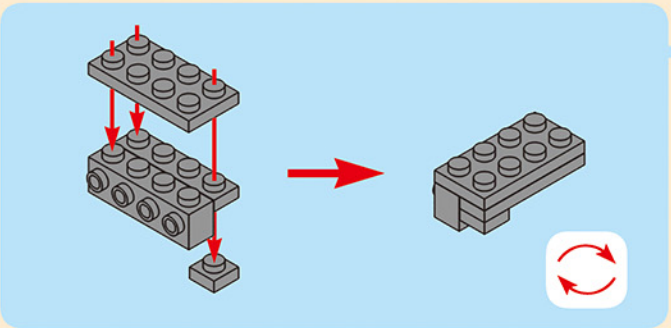

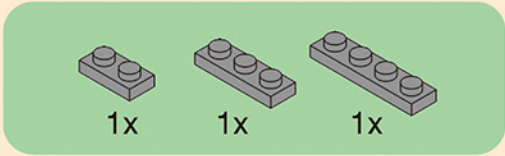

3-32.12.5

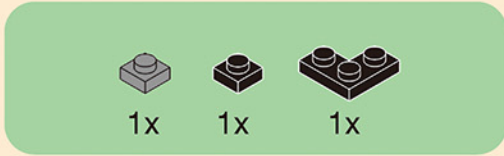
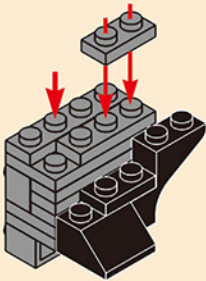

3-32.12.6

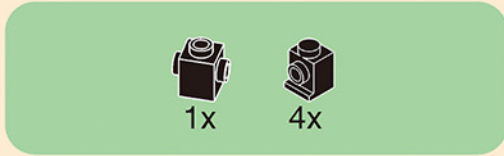
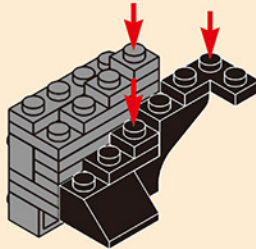

3-32.12.7

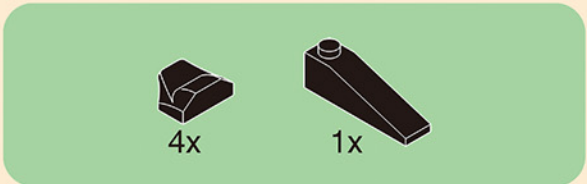
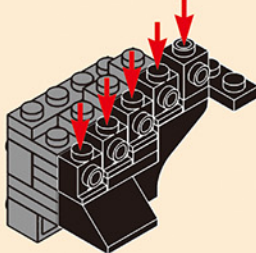

3-32.12.8

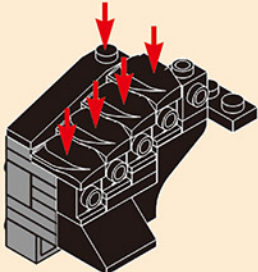

3-32.12

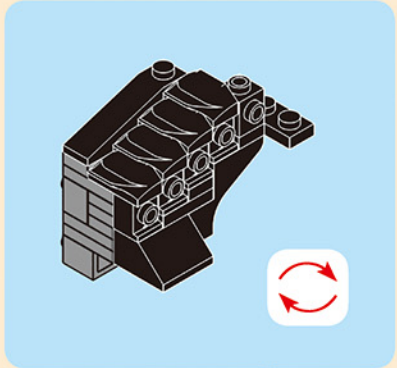
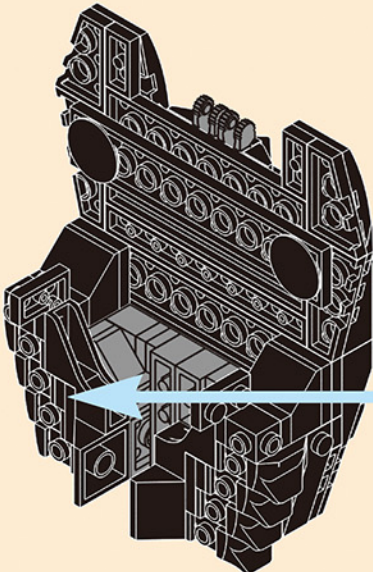

3-32

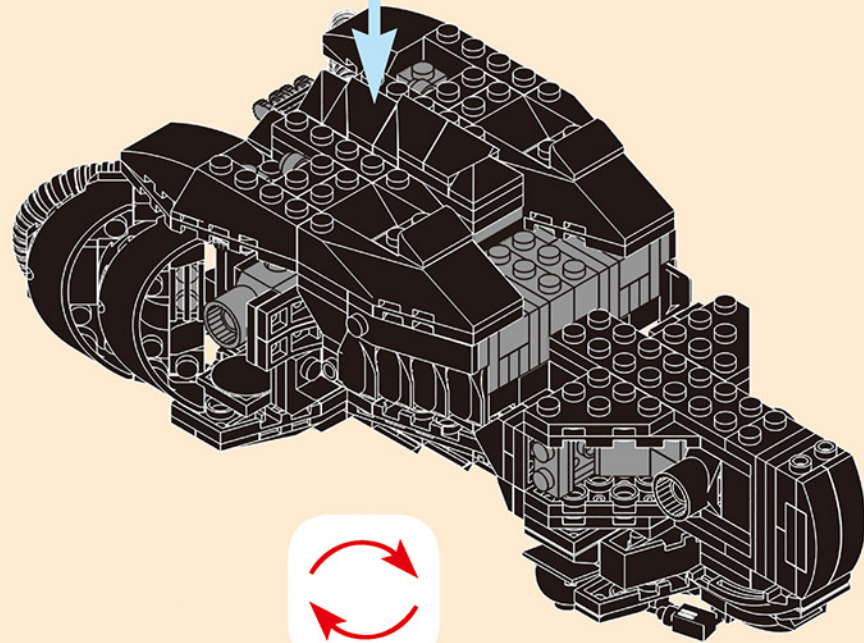
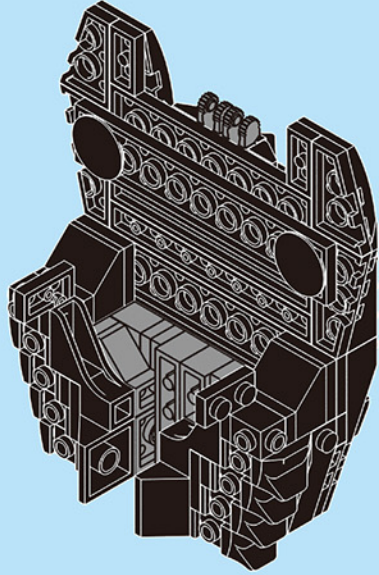

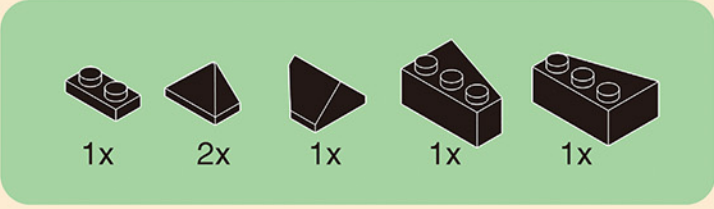

3-33

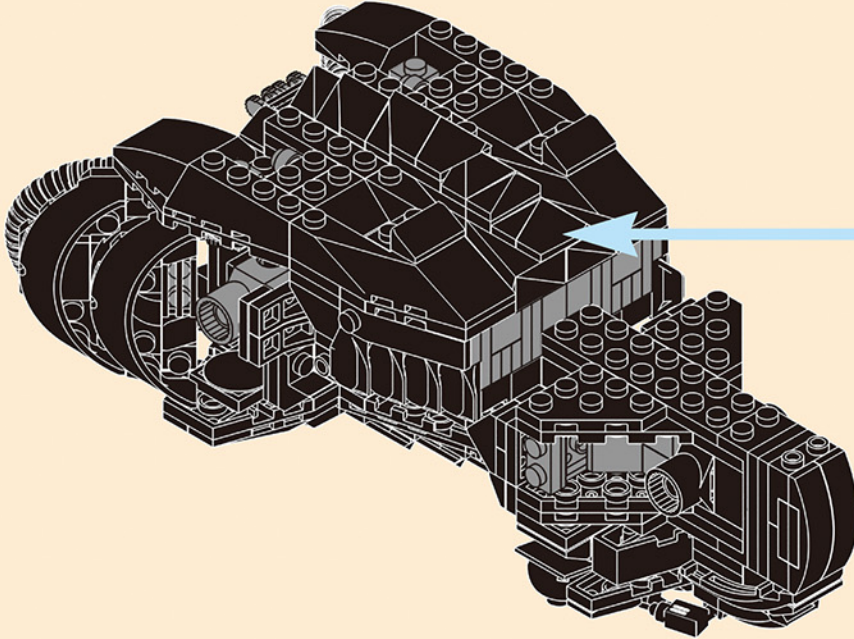
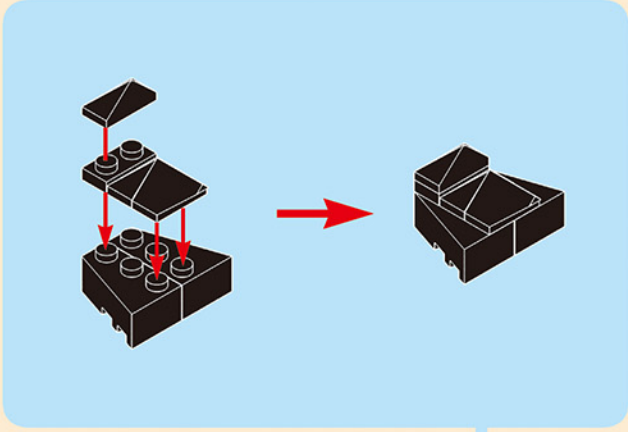

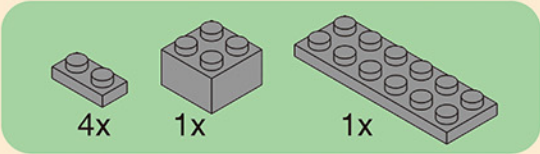

3-34.1

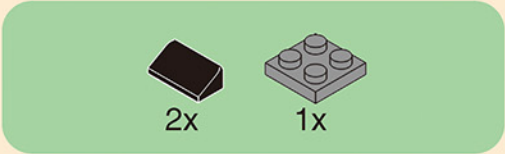
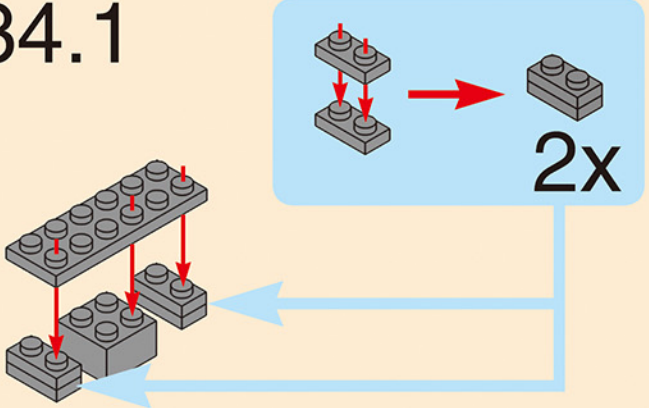

3-34.2

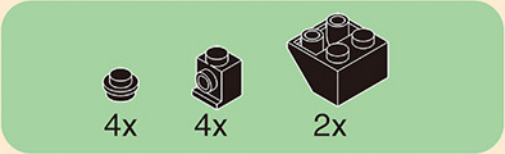
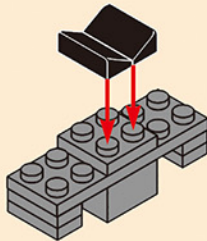

3-34.3

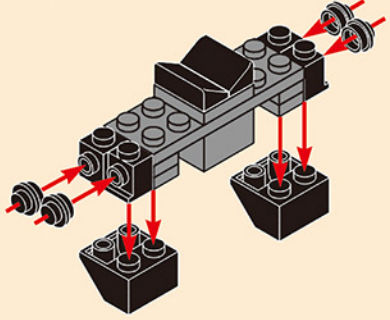

3-34.4

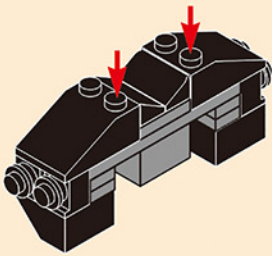

3-34

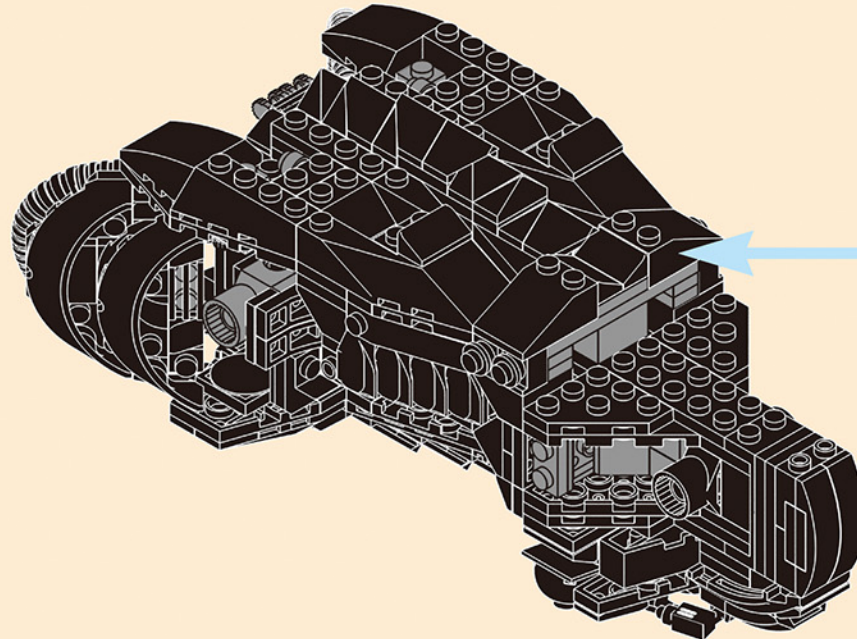
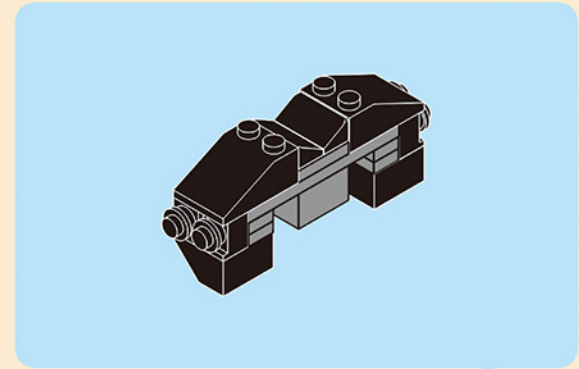

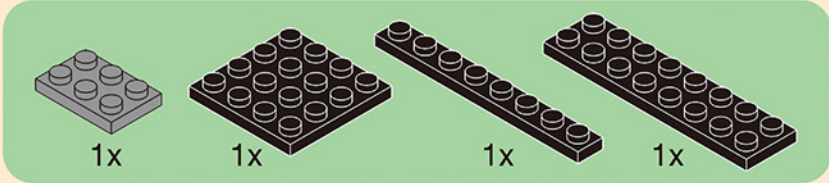

3-35.1

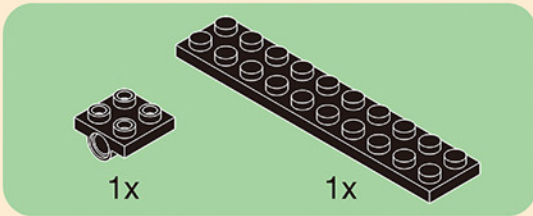
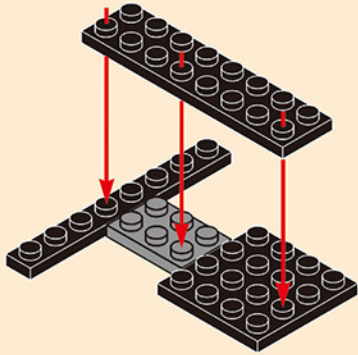

3-35.2

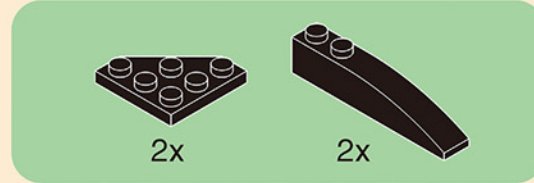
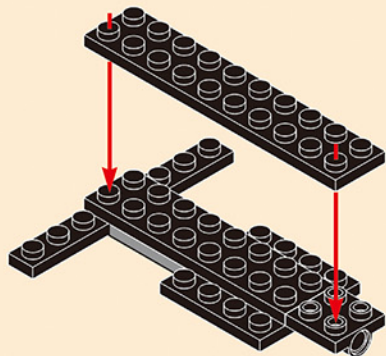

3-35.3

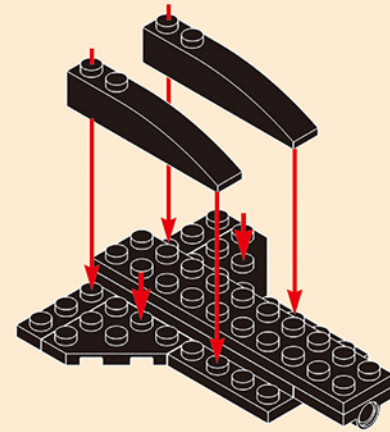

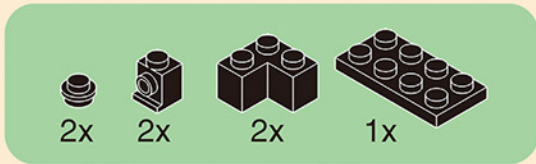

3-35.4

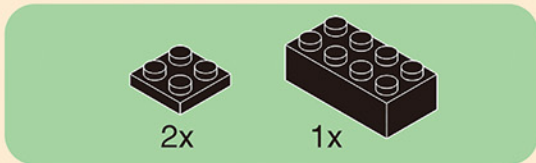
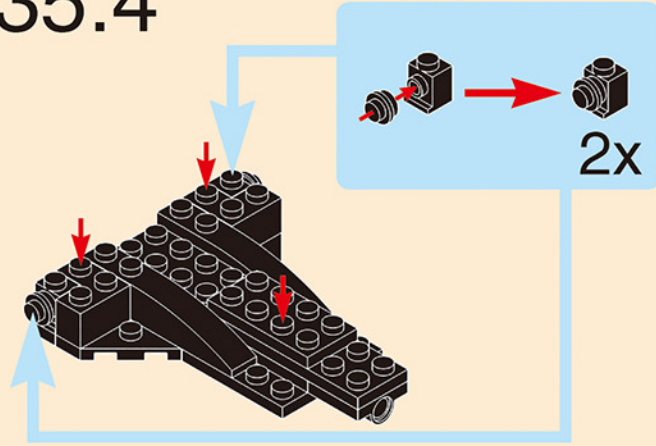

3-35.5

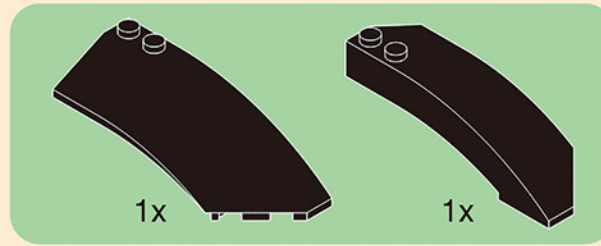
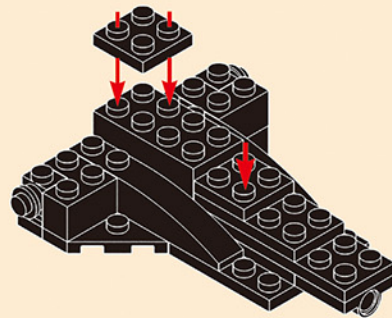

3-35.6

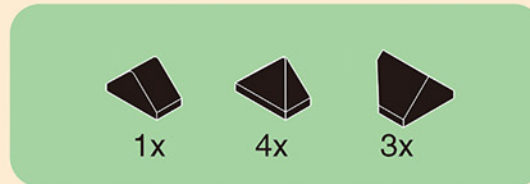
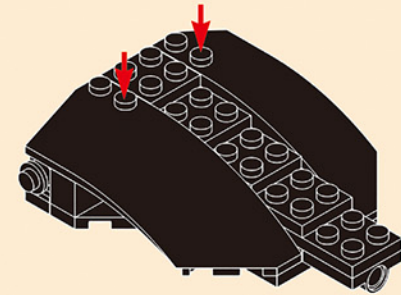

3-35.7

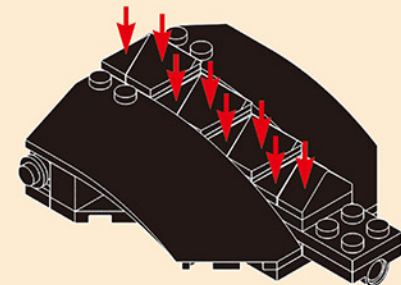

3-35

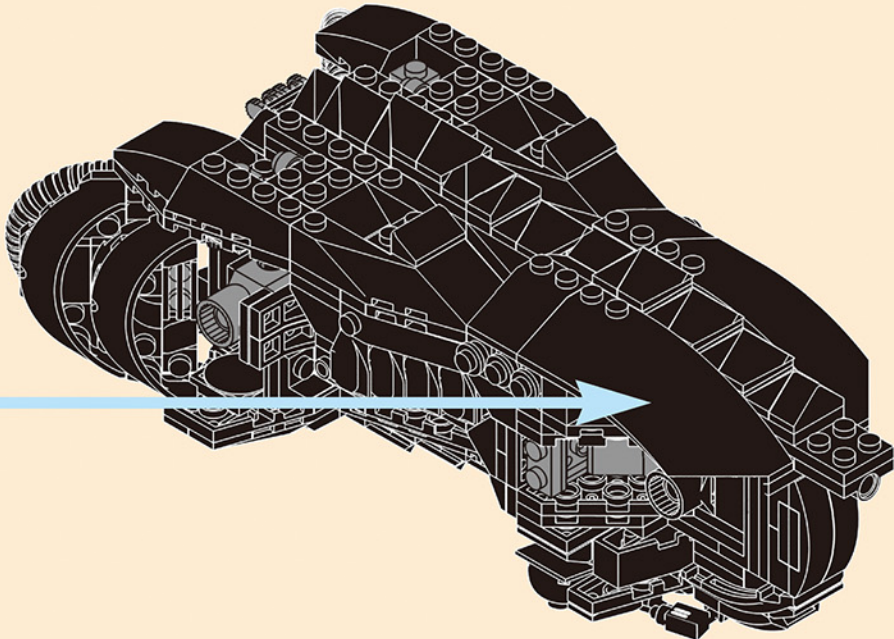
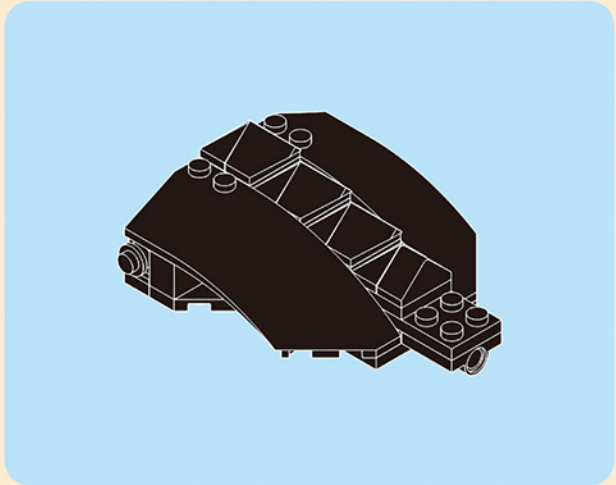

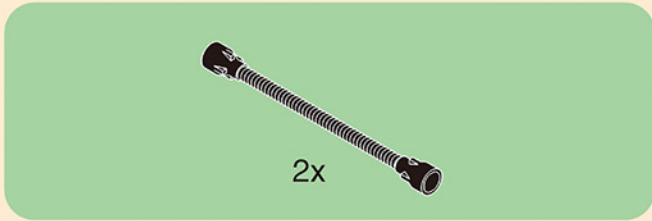

3-36

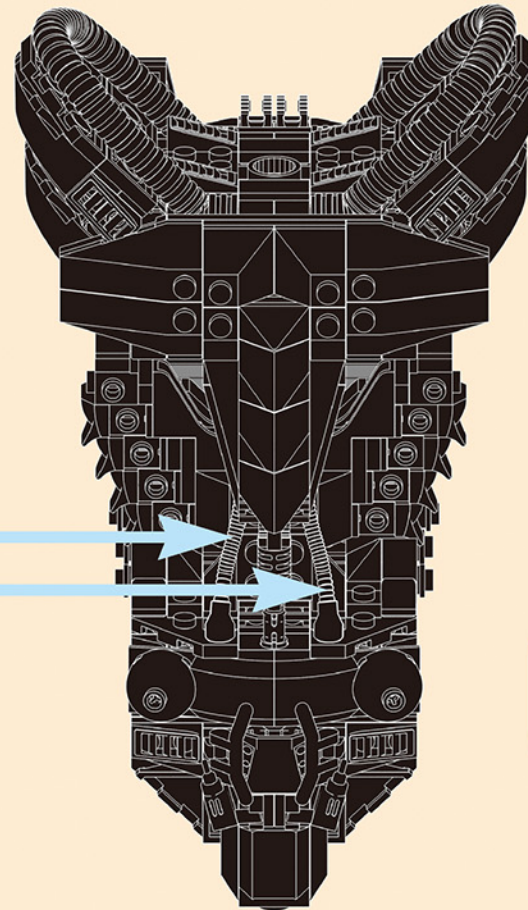
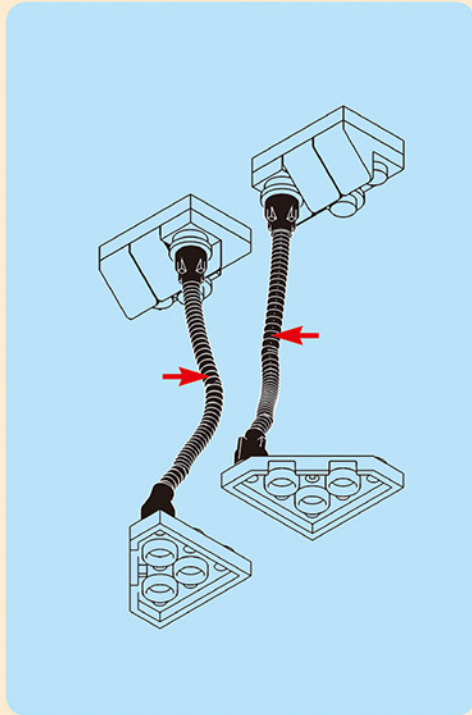

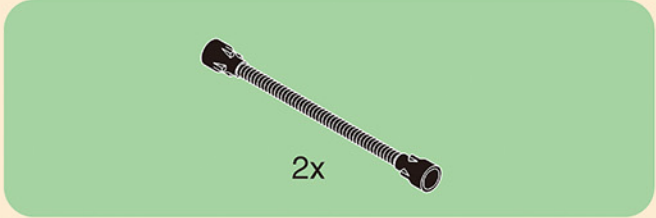

3-37

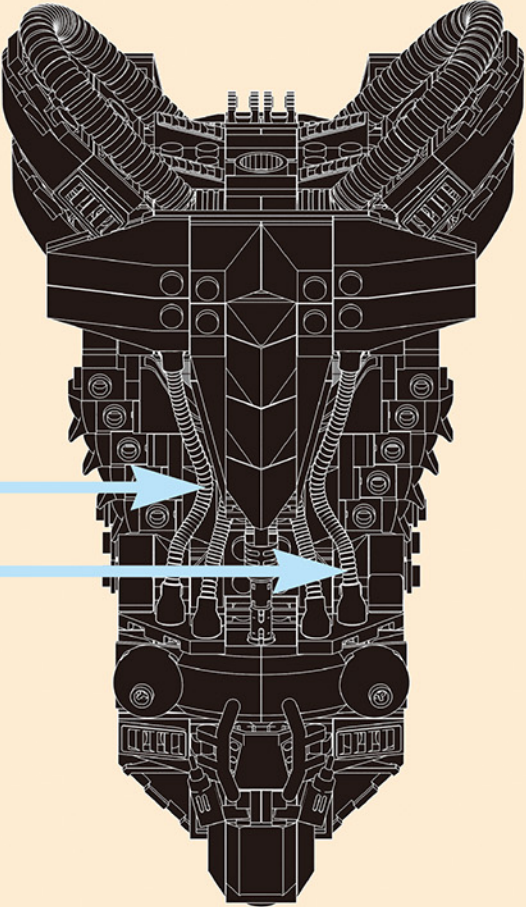
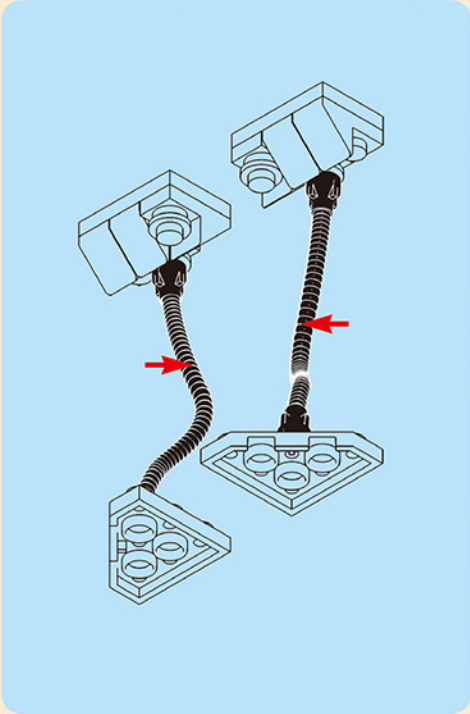

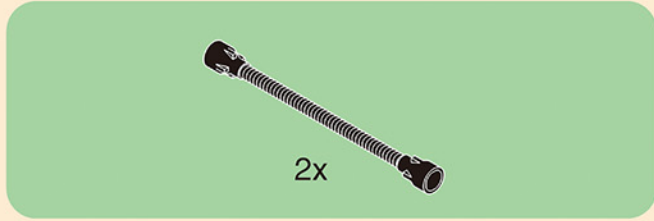

3-38

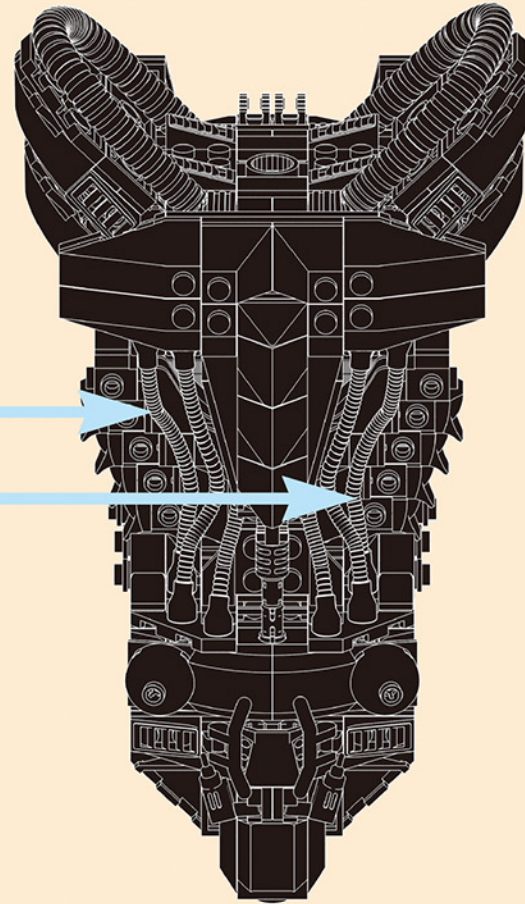
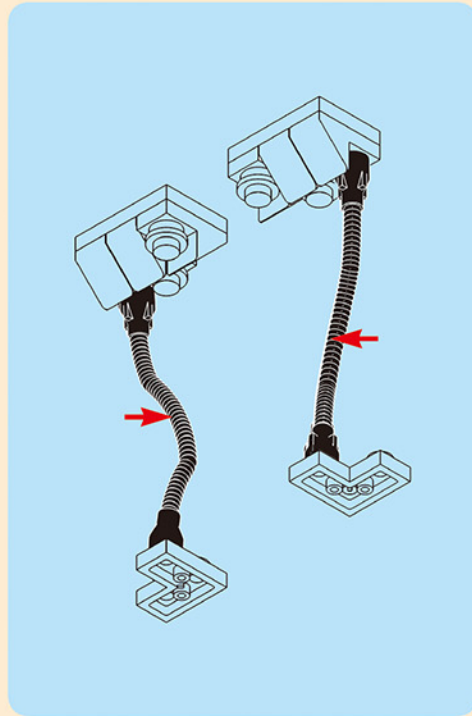

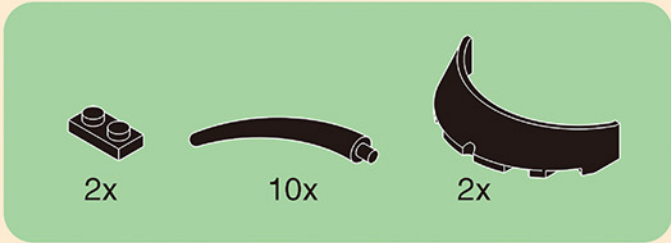

3-39

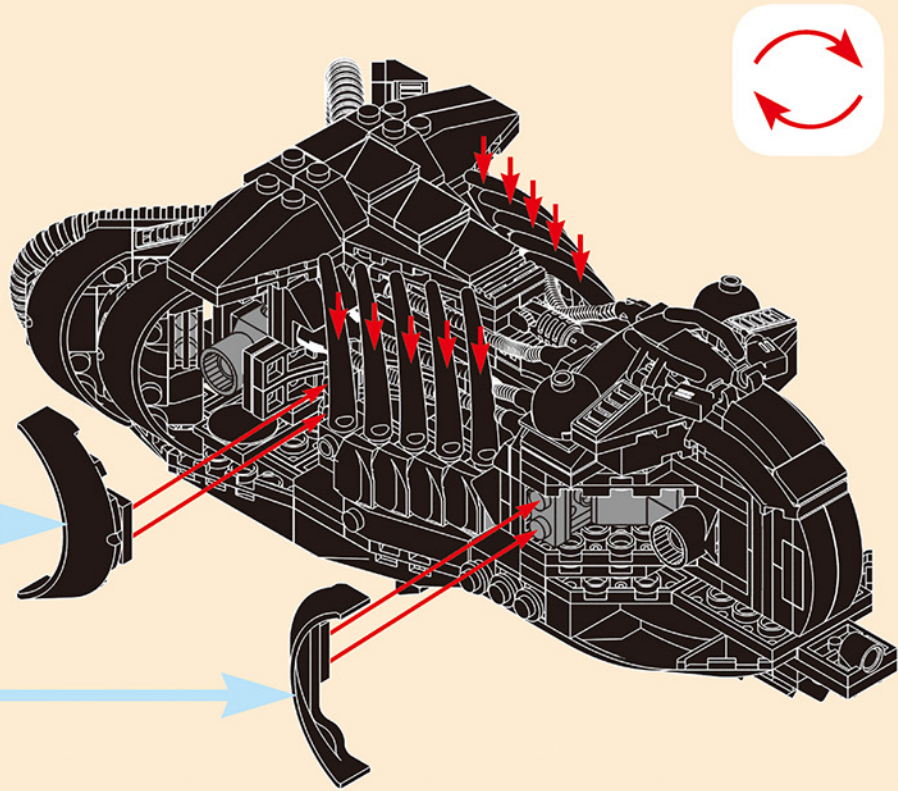
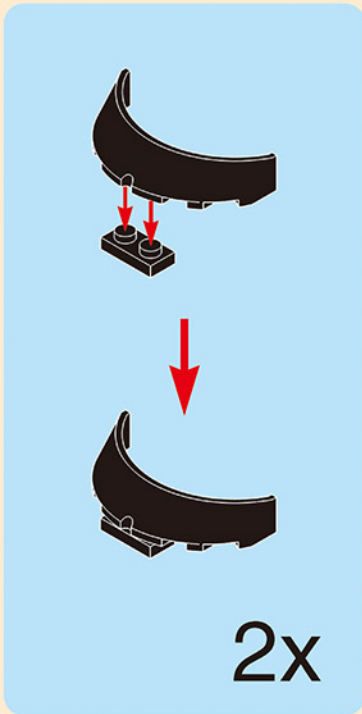

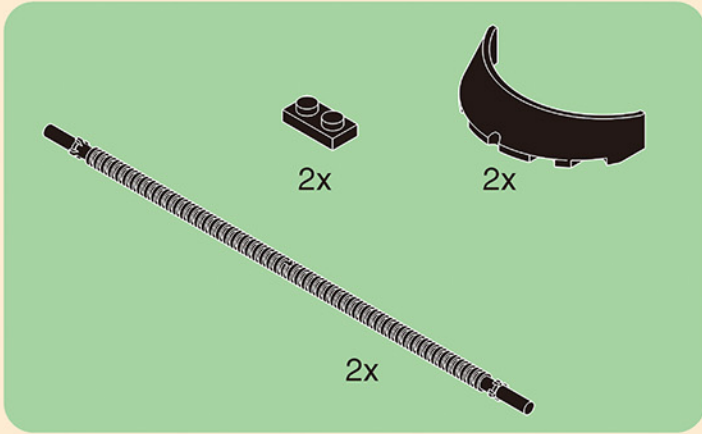

3-40

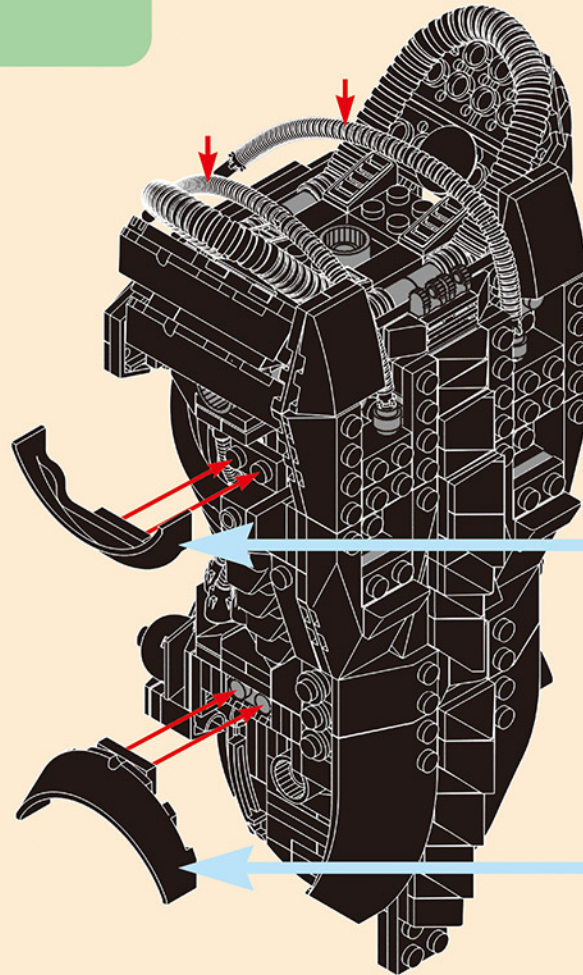
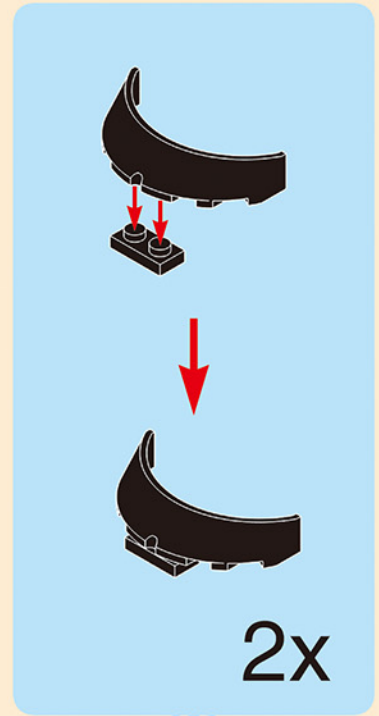

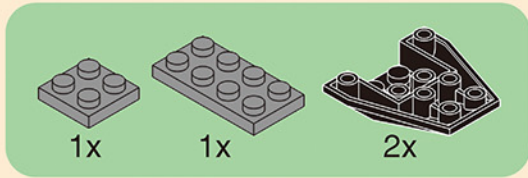

3-41.1

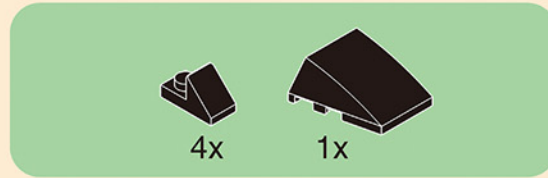
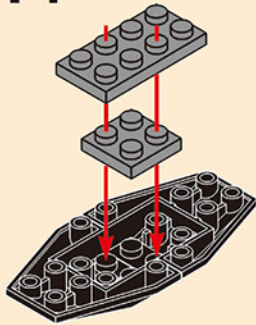

3-41.2

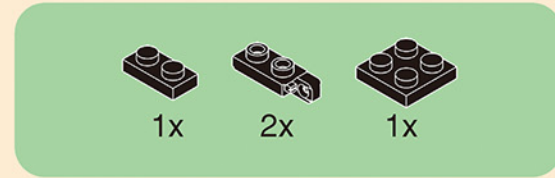
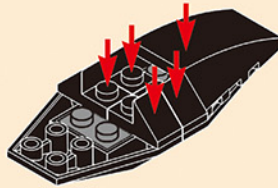

3-41.3

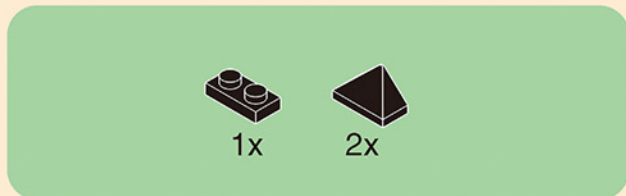
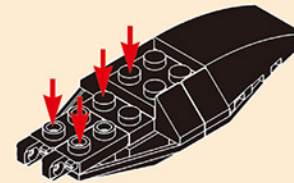

3-41.4

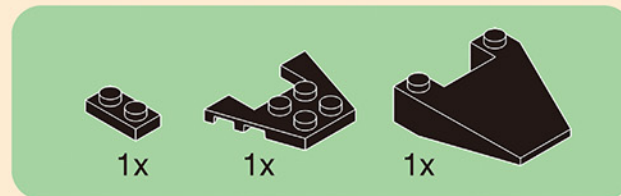
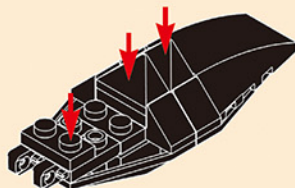

3-41.5

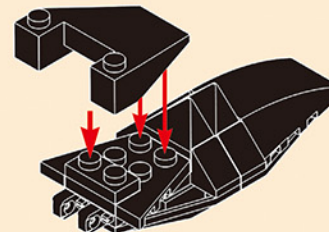



3-43

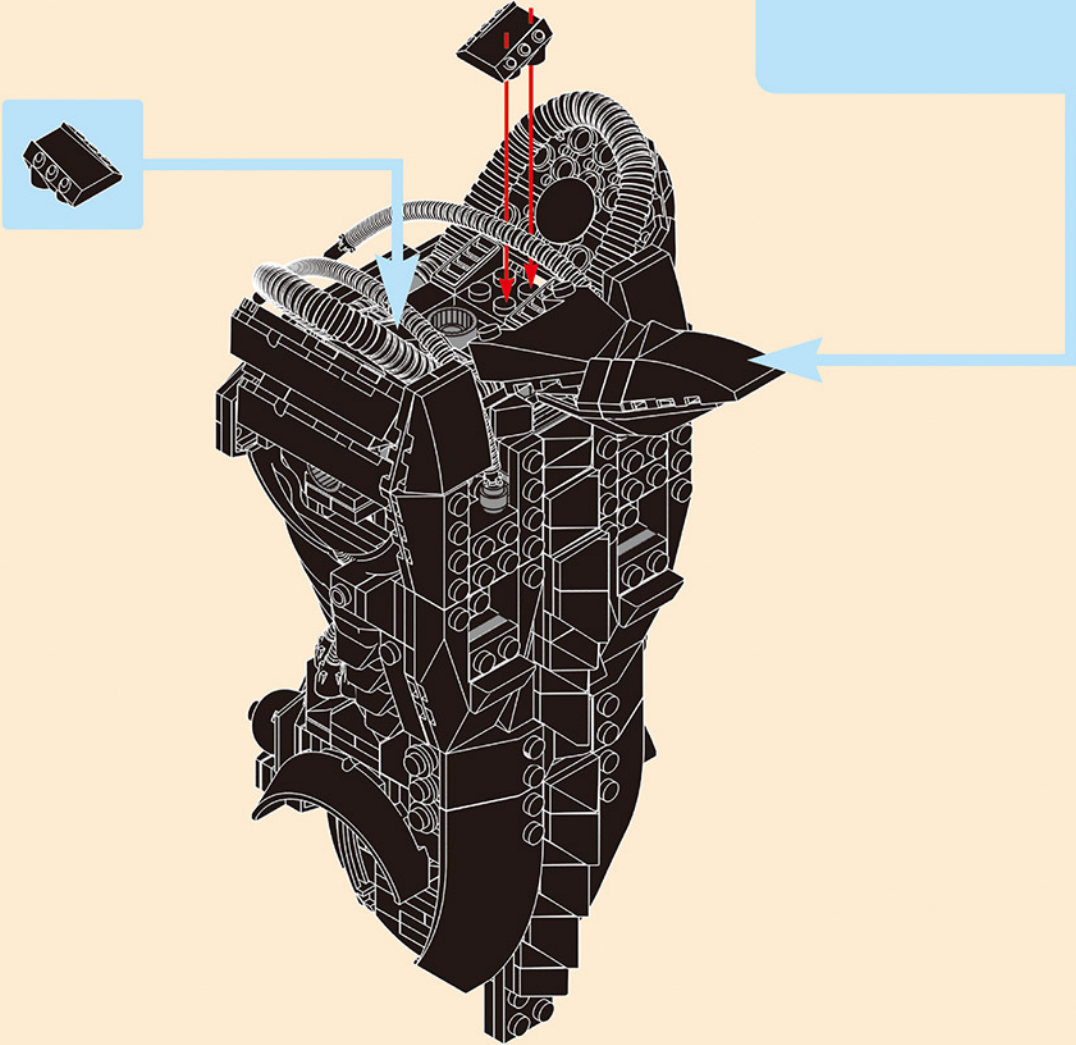
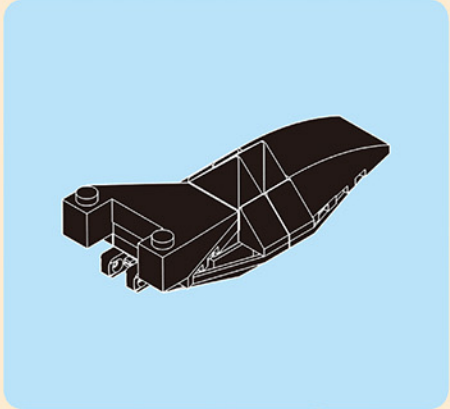

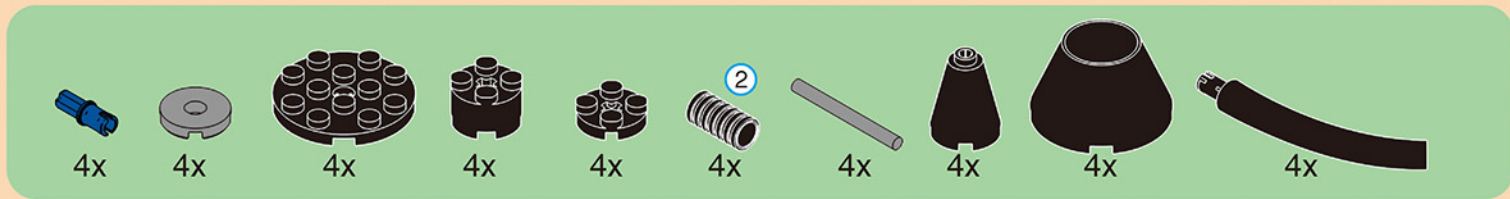

3-44A.1

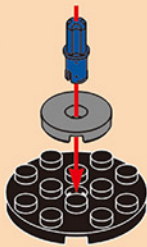

3-44A.3



3-44A.2

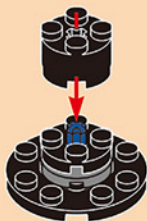

3-44A.4



4x

3-44A

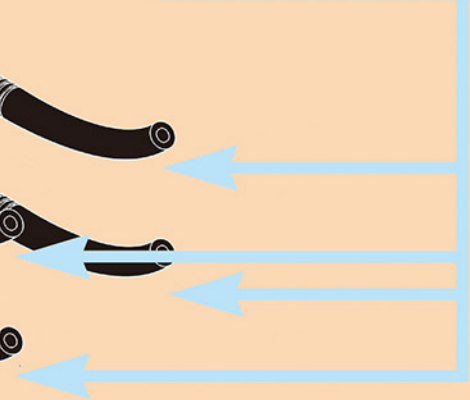
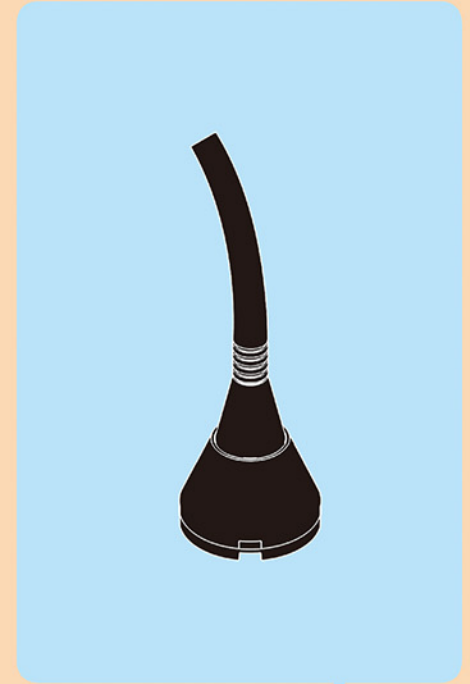
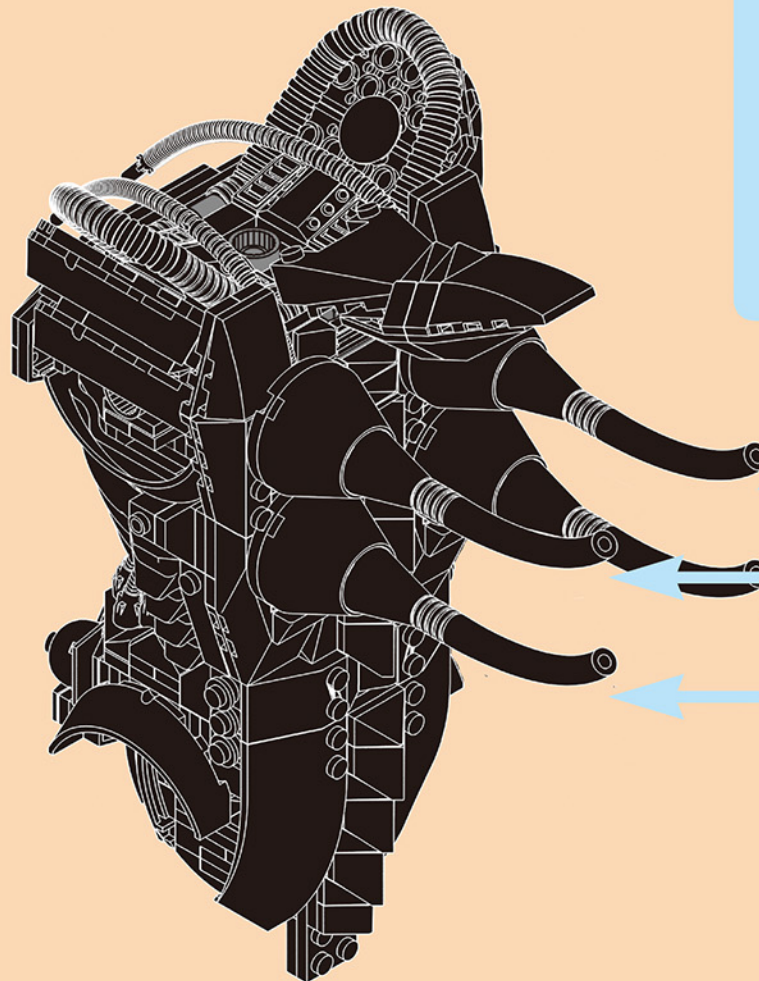

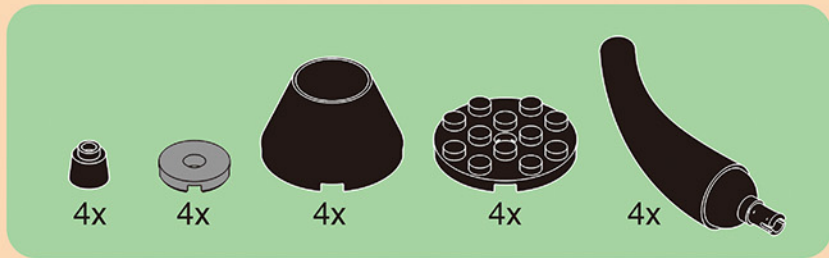

3-44B

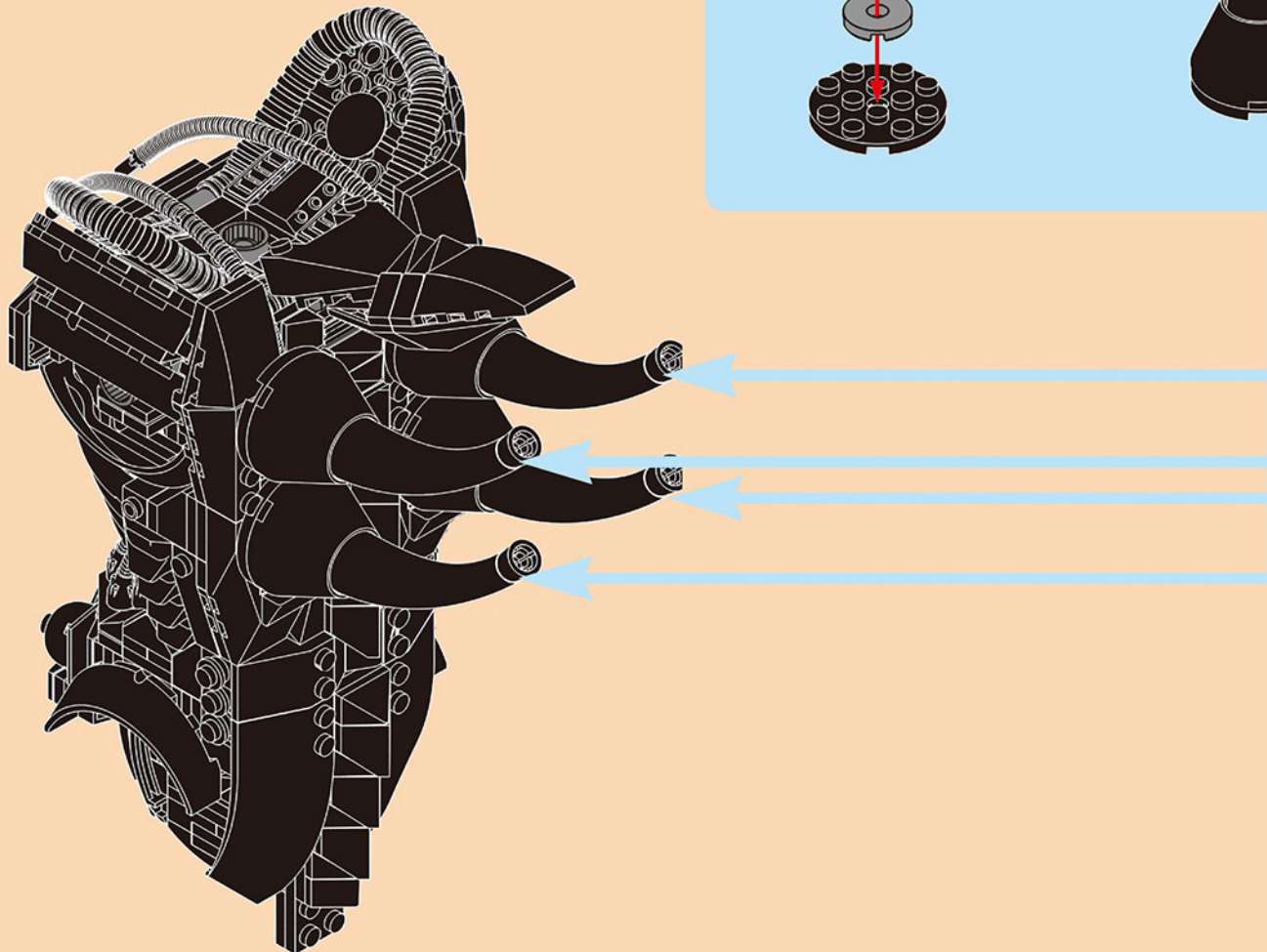
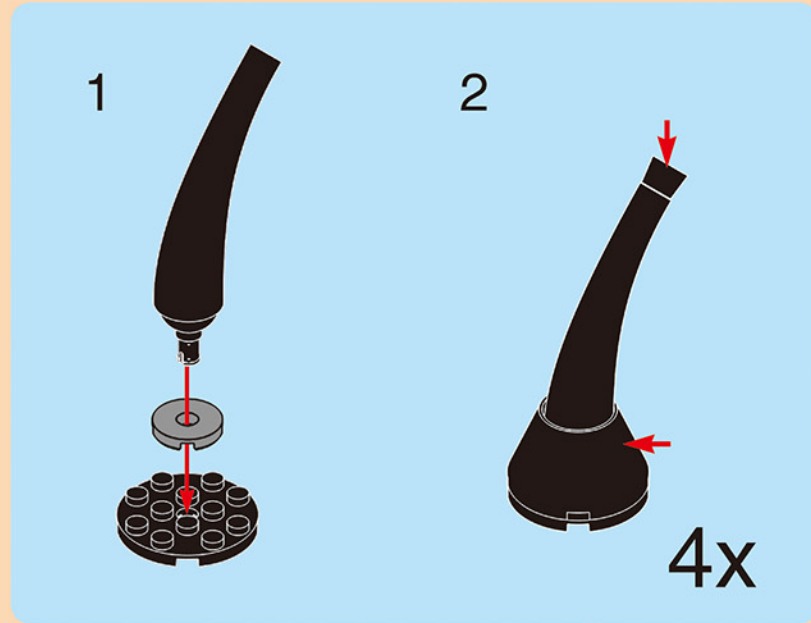

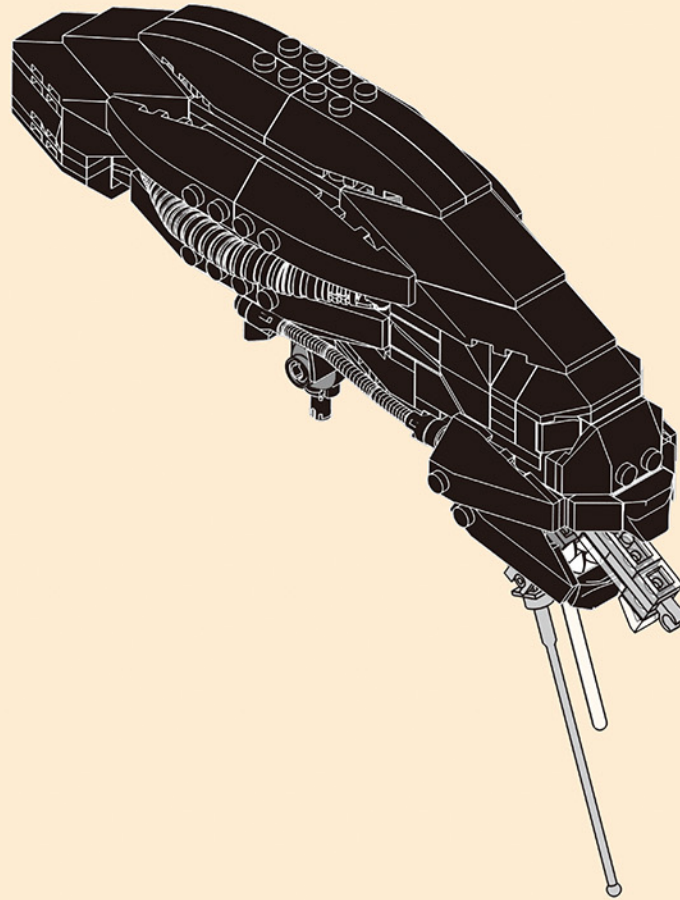

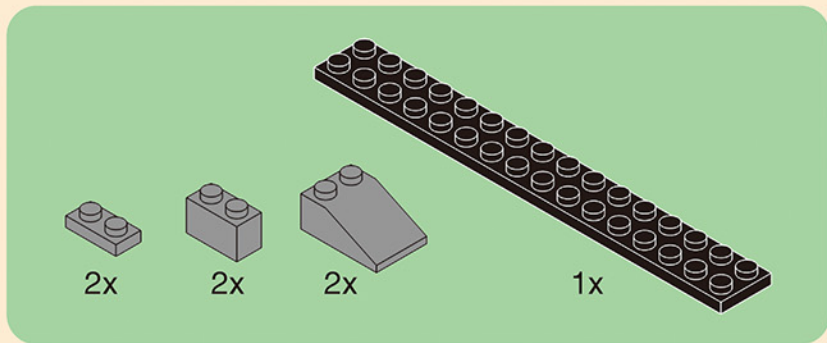

4-1

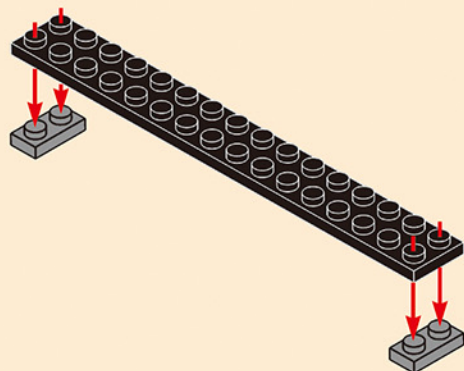

4-2

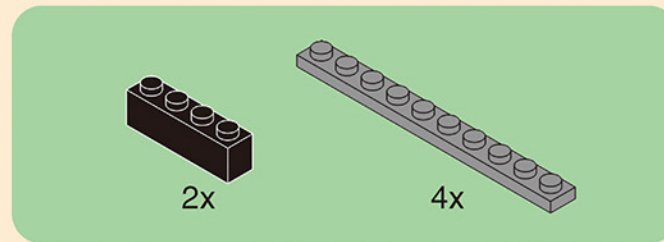
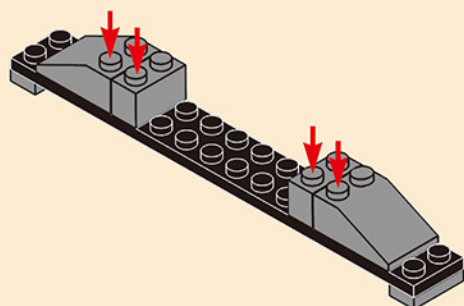

4-3

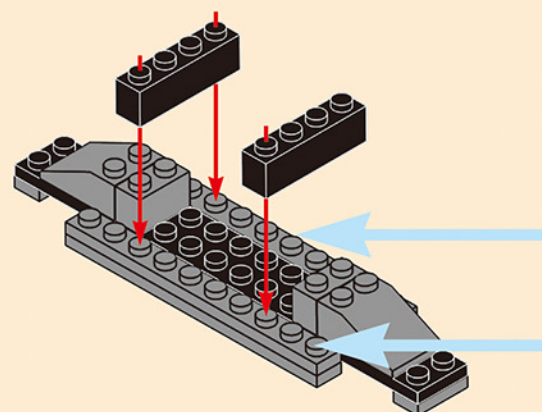
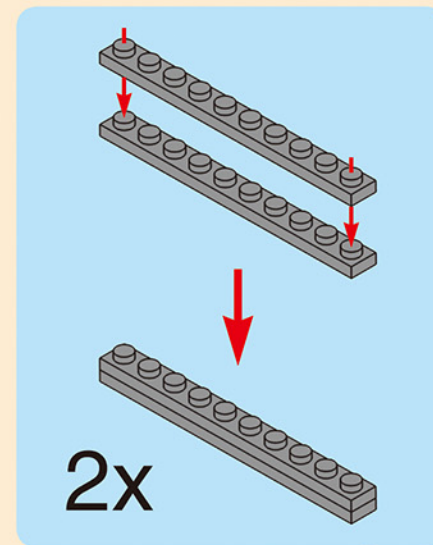

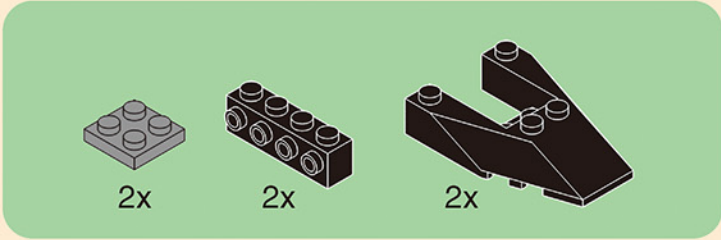

4-4

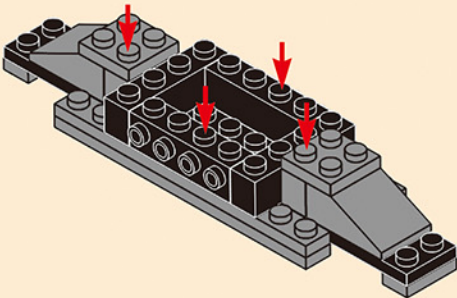

4-5

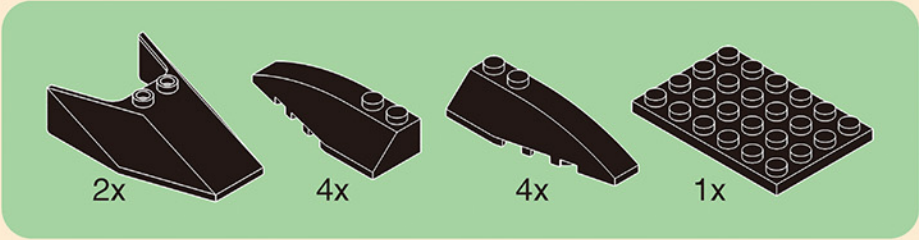
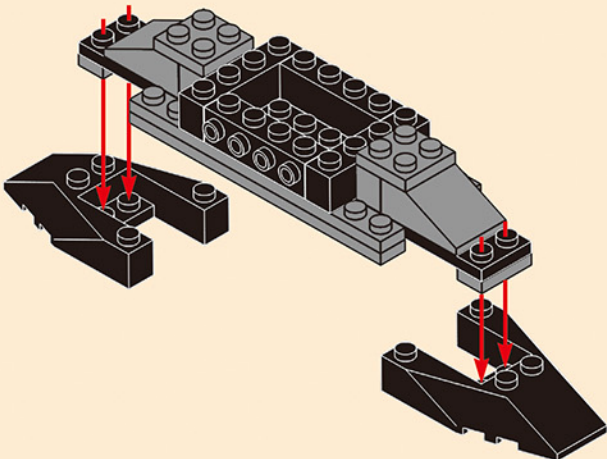

4-6

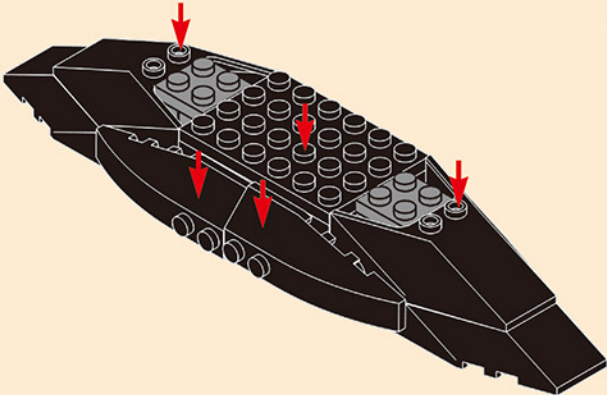

4-7

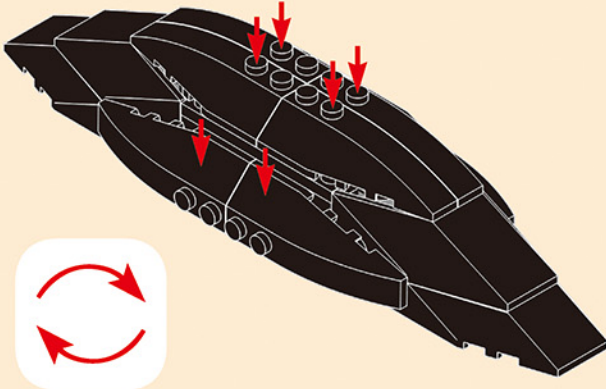

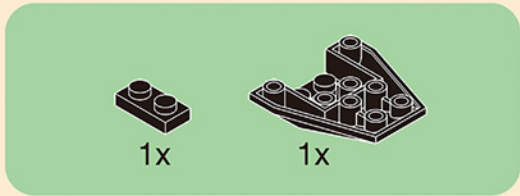

4-8.1

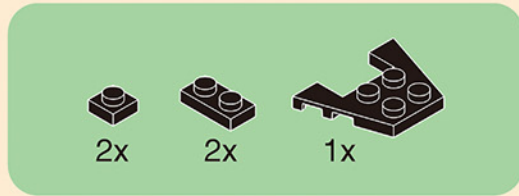
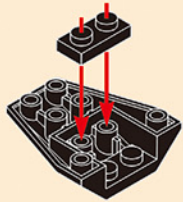

4-8.2

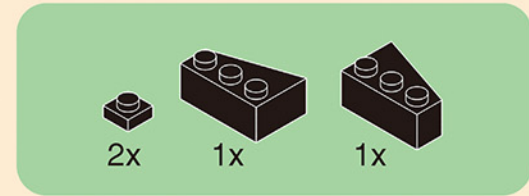
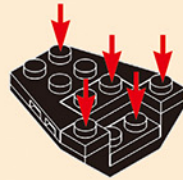

4-8.3

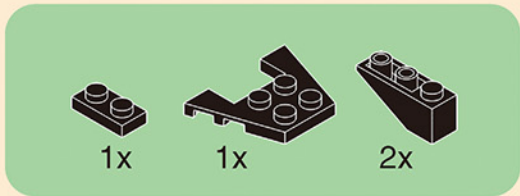
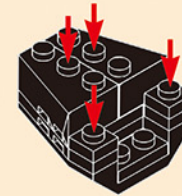

4-8.4

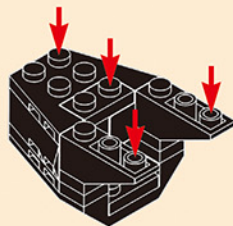

4-8

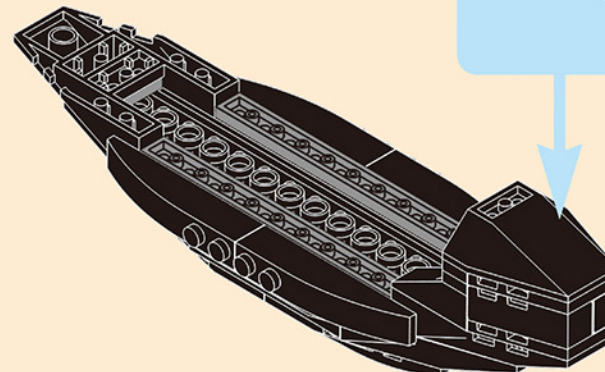
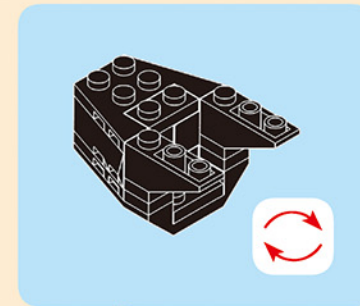

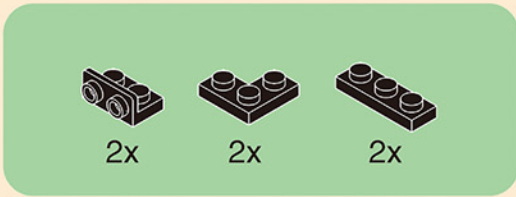

4-9.1

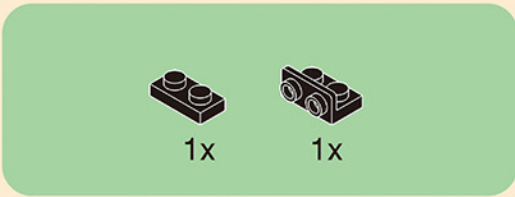
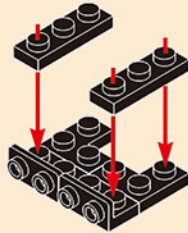

4-9.2

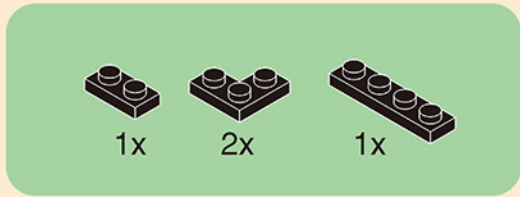
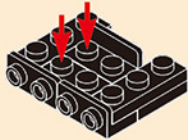

4-9.3

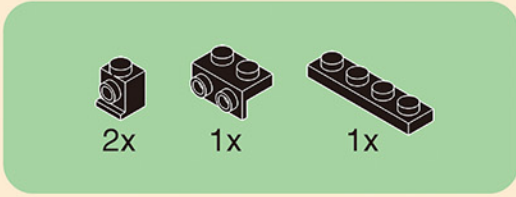
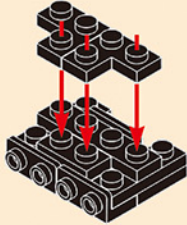

4-9.4

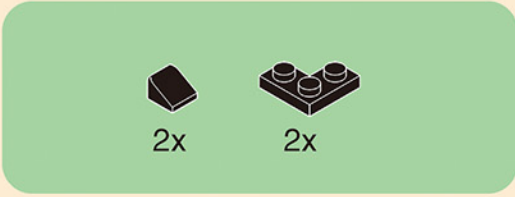
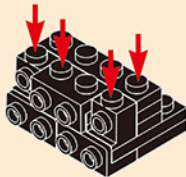

4-9.5

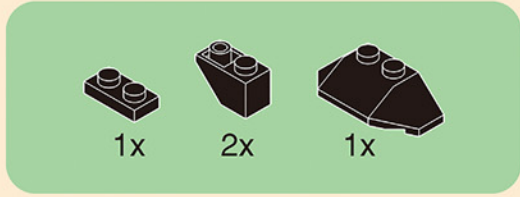
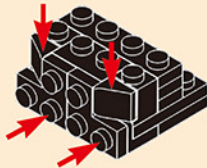

4-9.6

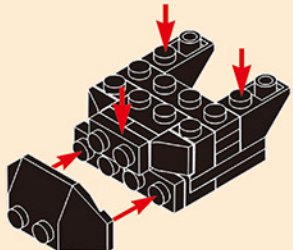

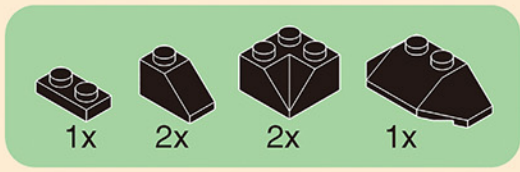

4-9.7

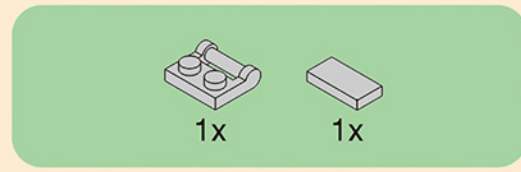
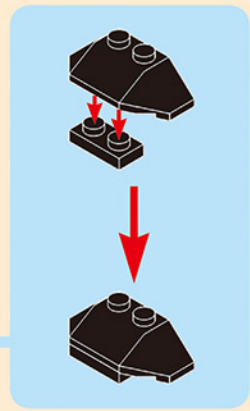
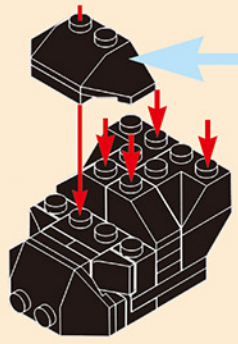

4-9.8

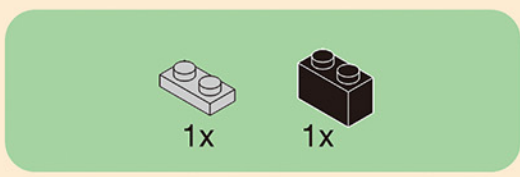
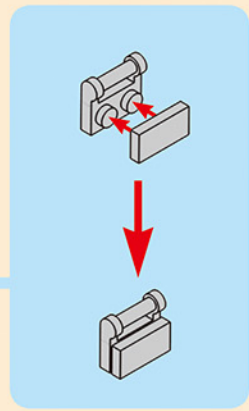
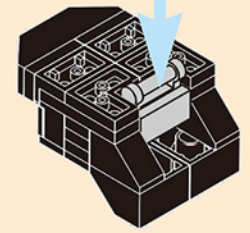

4-9.9

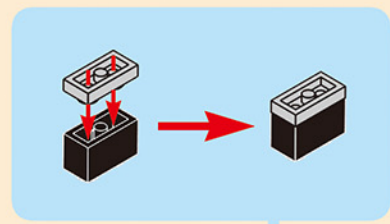
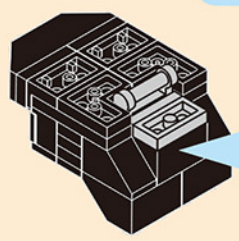

4-9

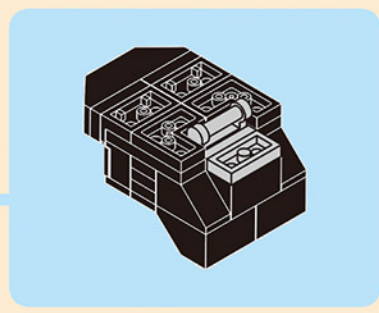
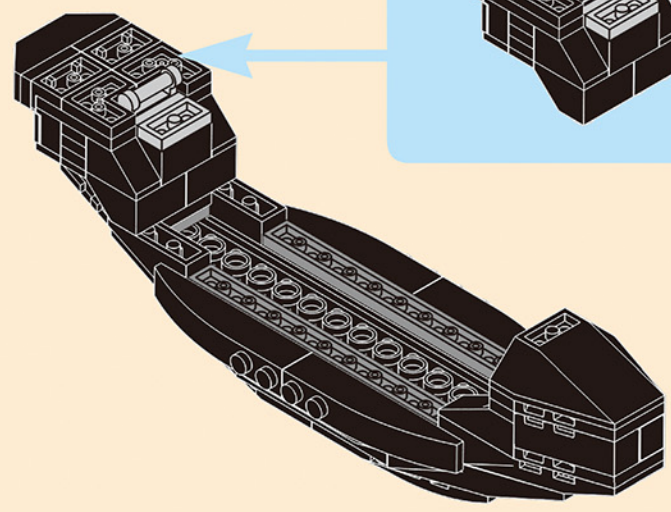

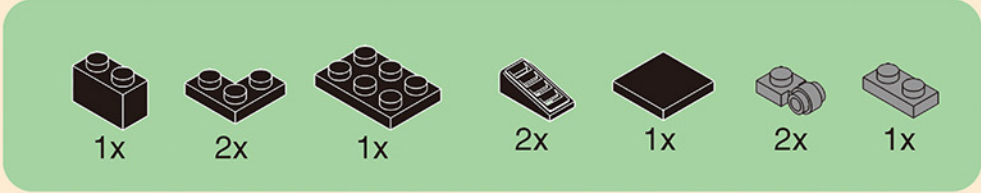

4-10.1

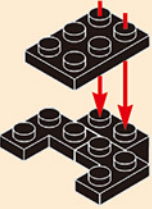

4-10.2

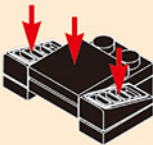

4-10.3

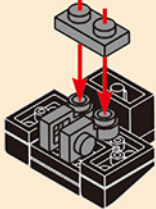

4-10

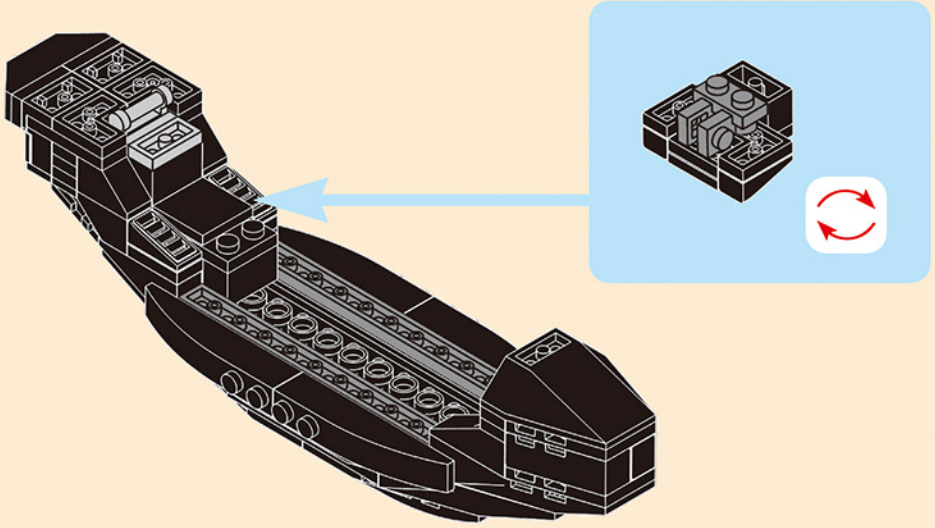

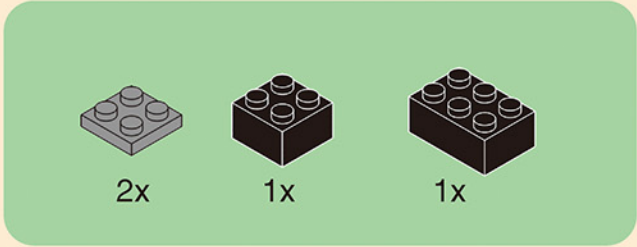

4-11

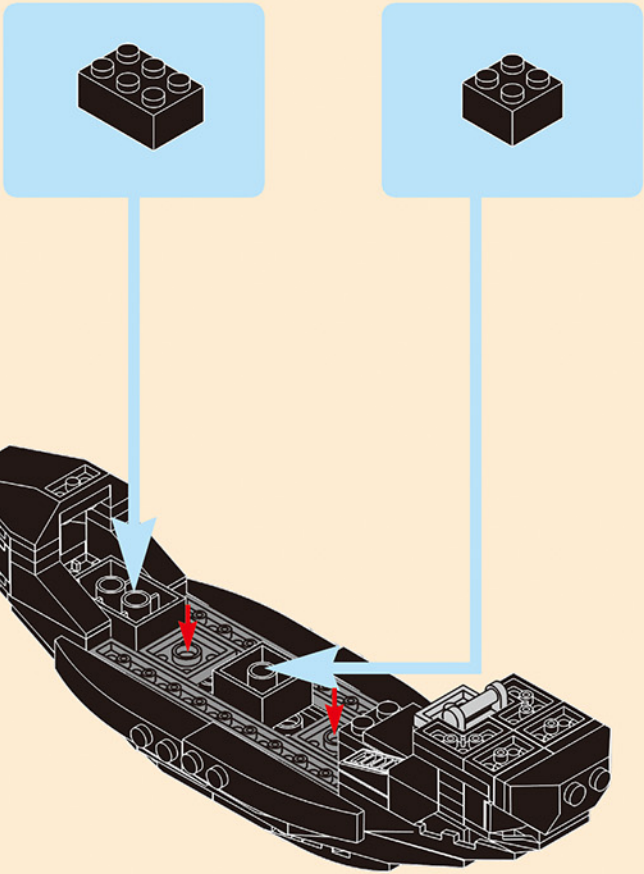

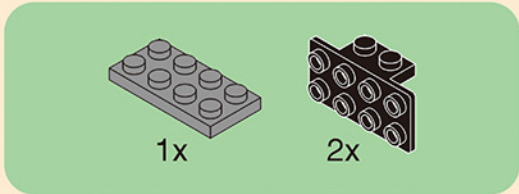

4-12.1

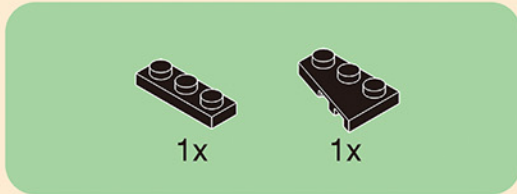
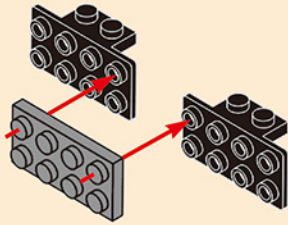

4-12.2

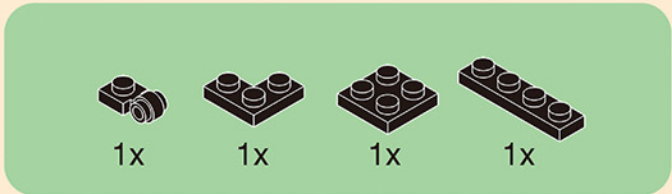
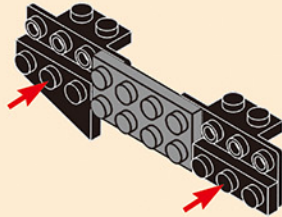

4-12.3

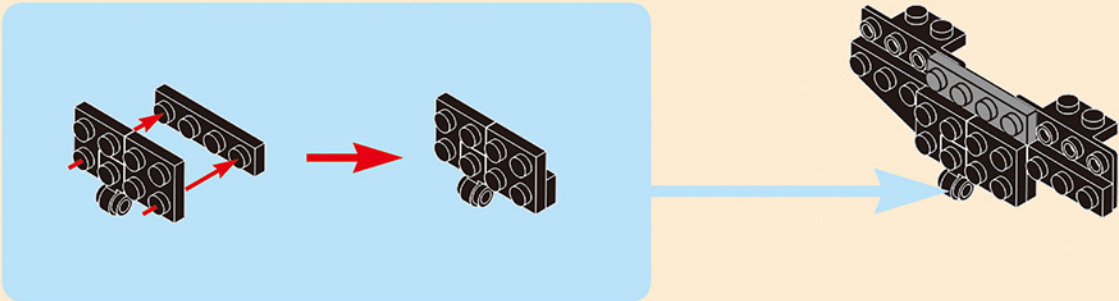

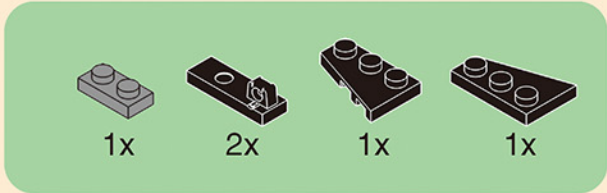

4-12.4

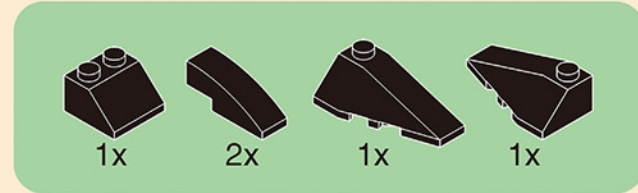
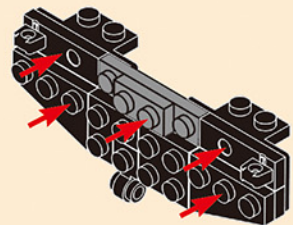

4-12.5

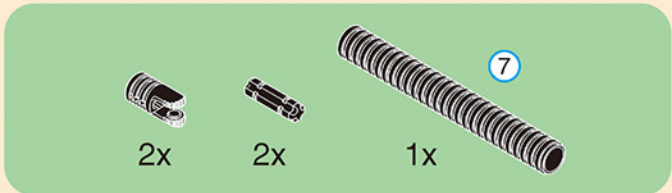
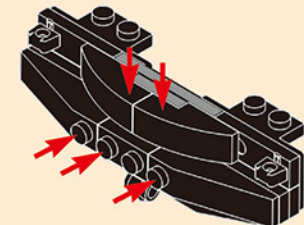

4-12.6

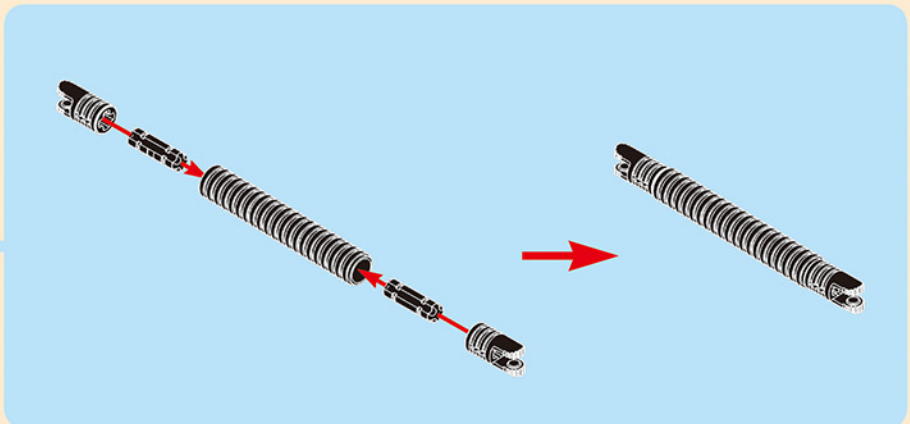
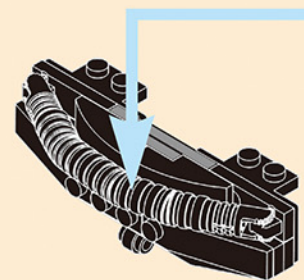

4-12

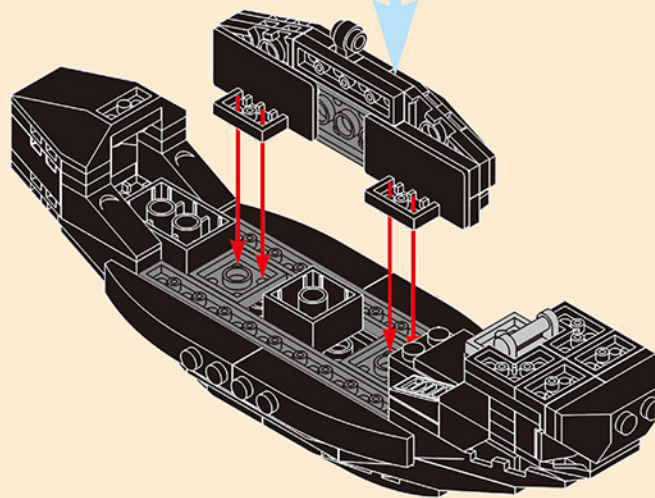
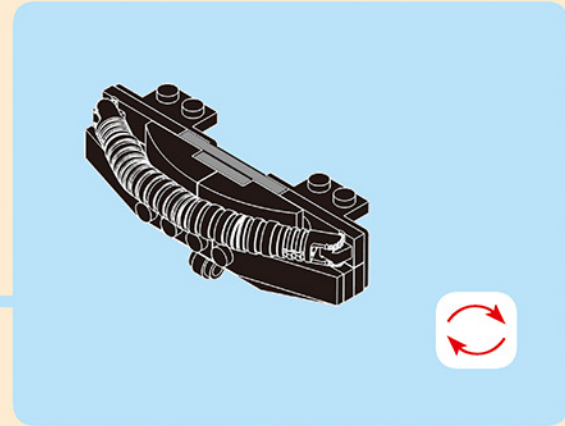

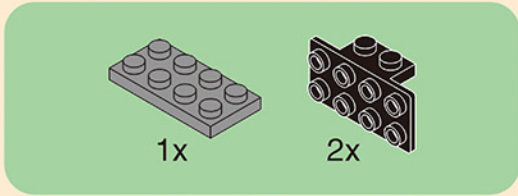

4-13.1

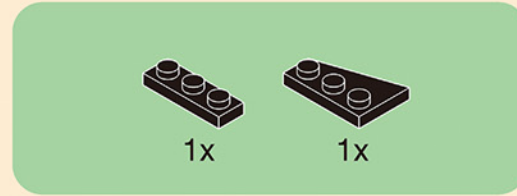
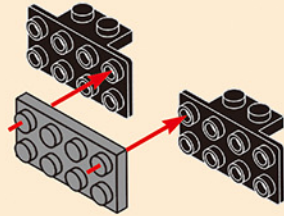

4-13.2

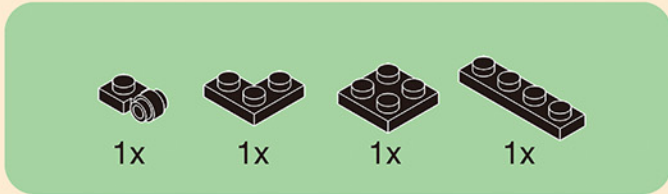
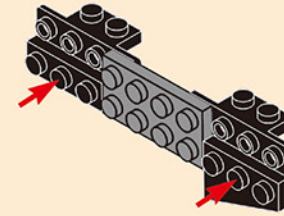

4-13.3

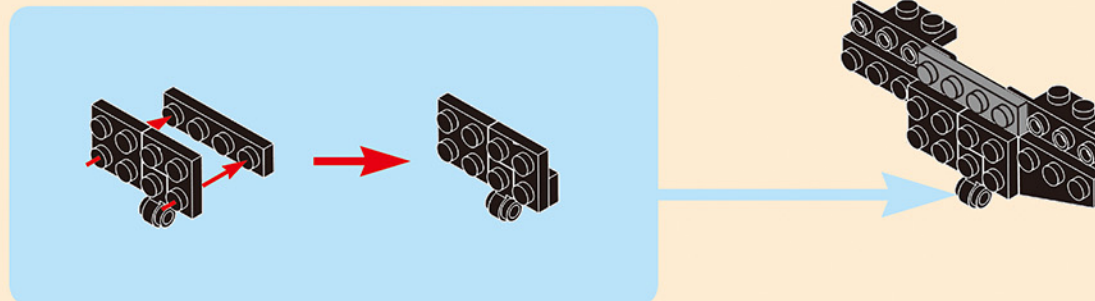

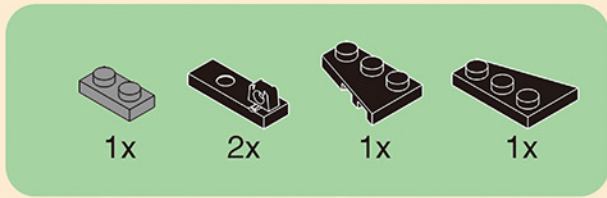

4-13.4

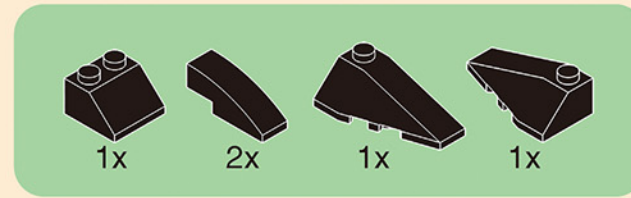
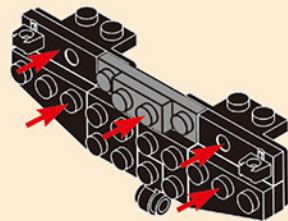

4-13.5

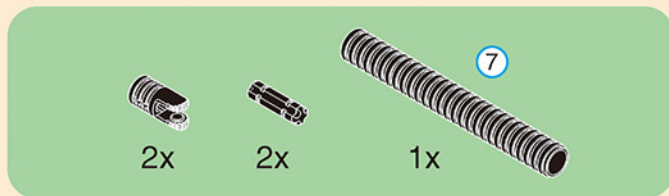
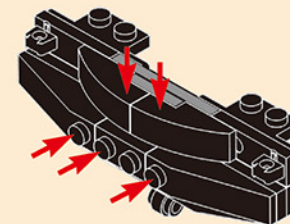

4-13.6

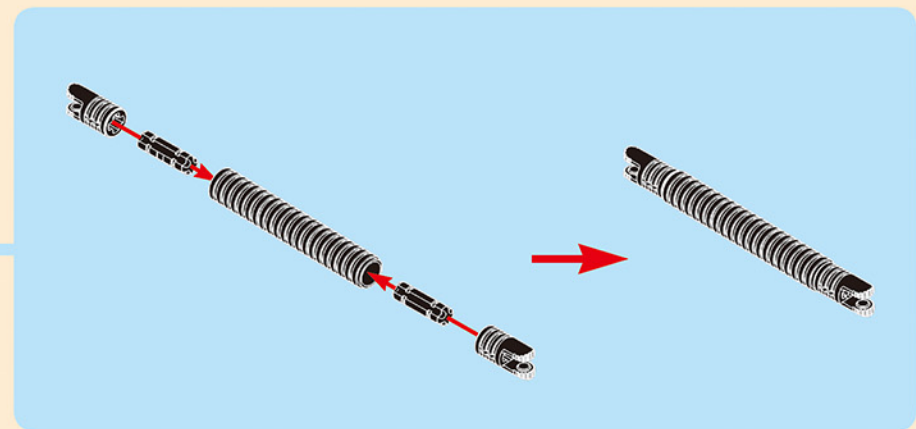
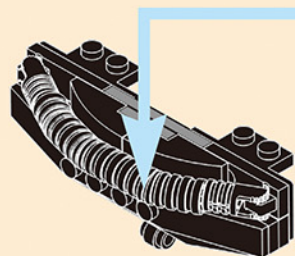

4-13

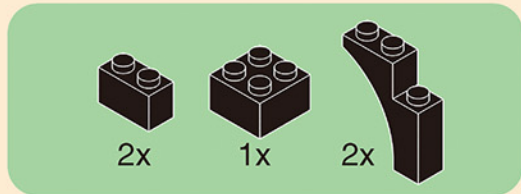
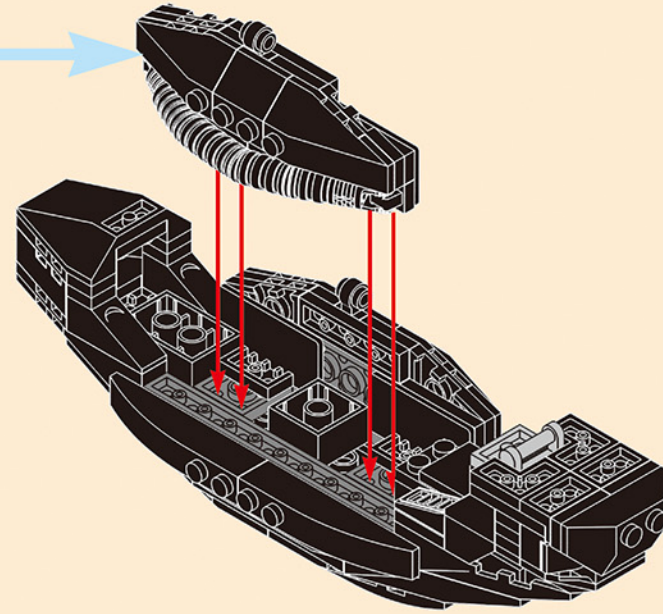
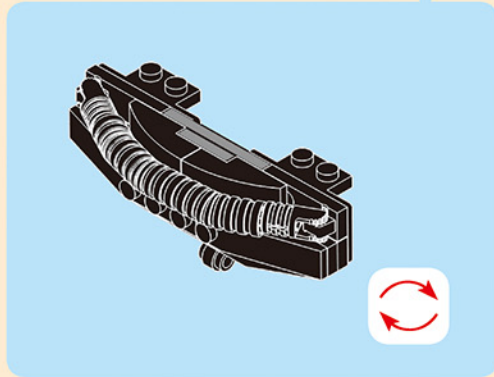

4-14.1

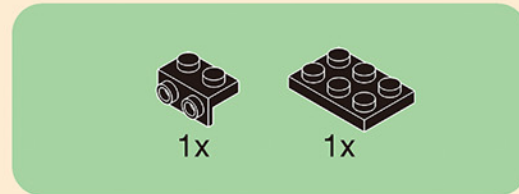
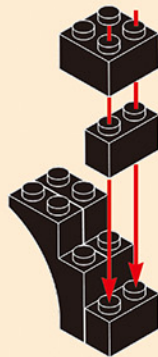

4-14.2

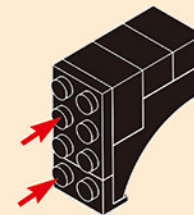

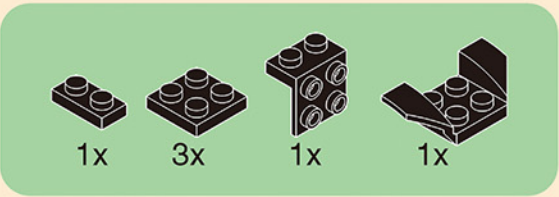

4-14.3

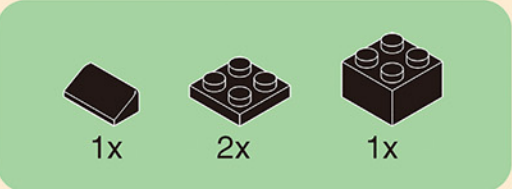
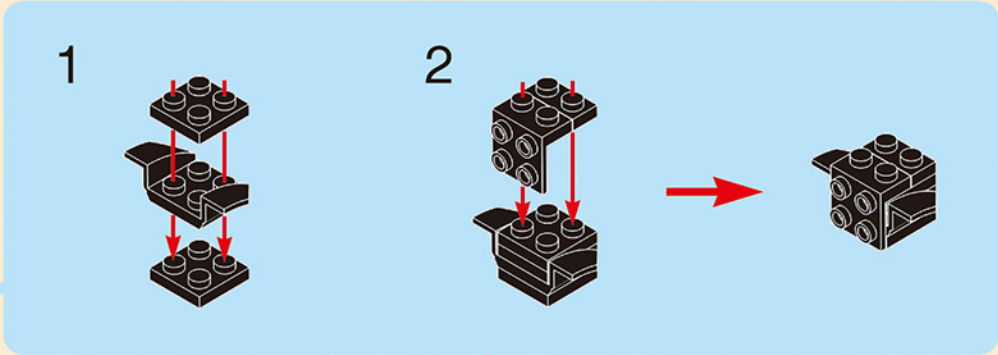
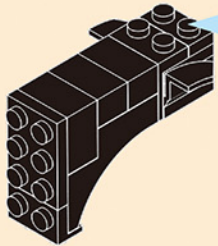

4-14.4

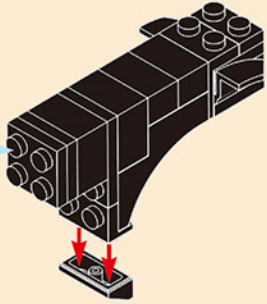
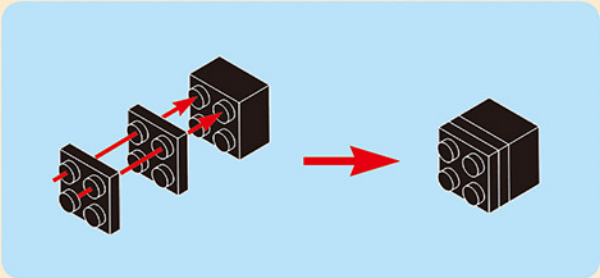

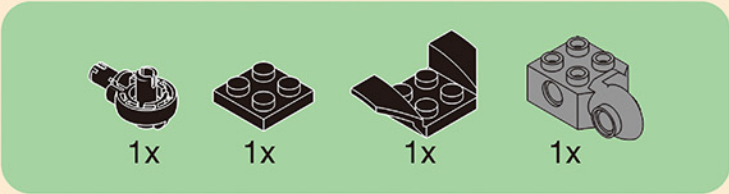

4-14.5

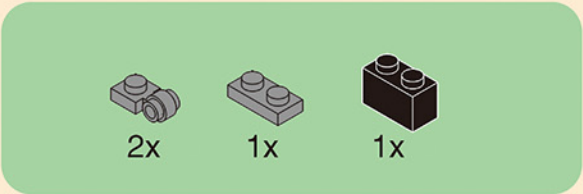
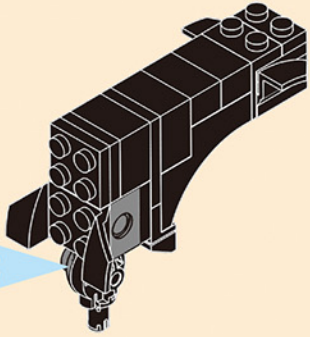
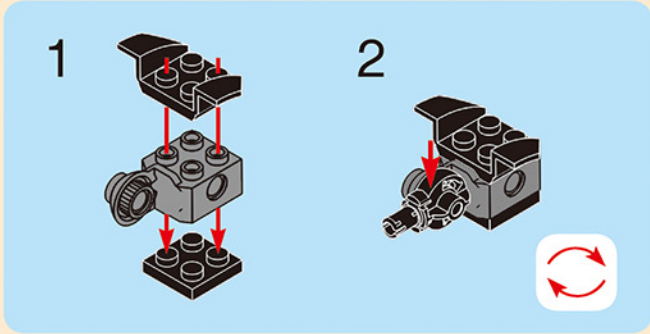

4-14.6.1

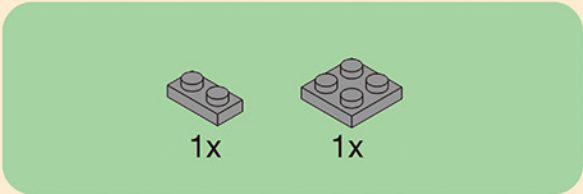

4-14.6.2

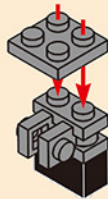

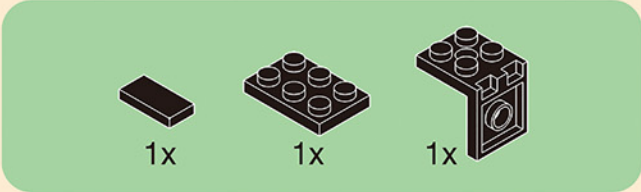

4-14.6.3

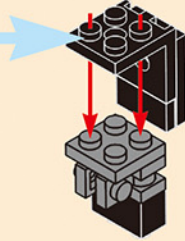
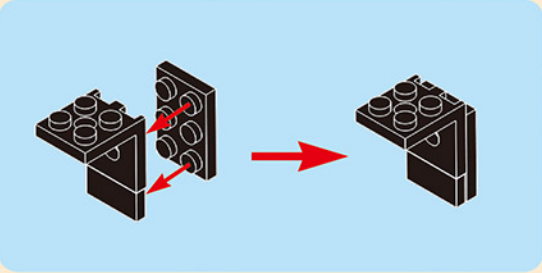

4-14.6

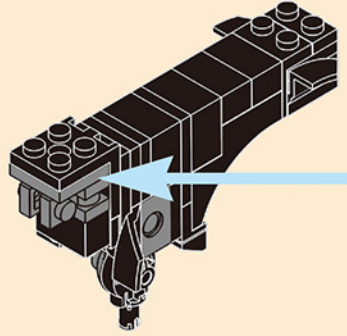
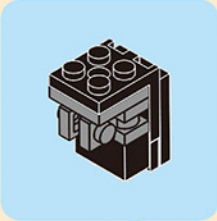

4-14

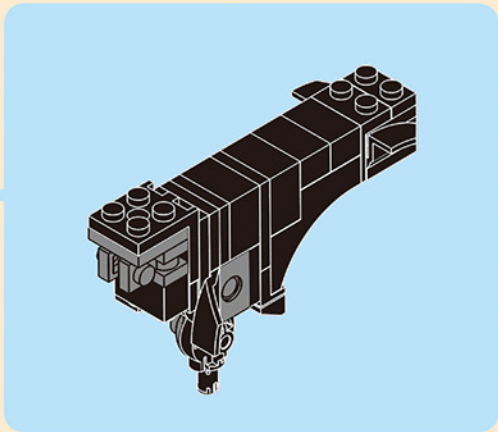
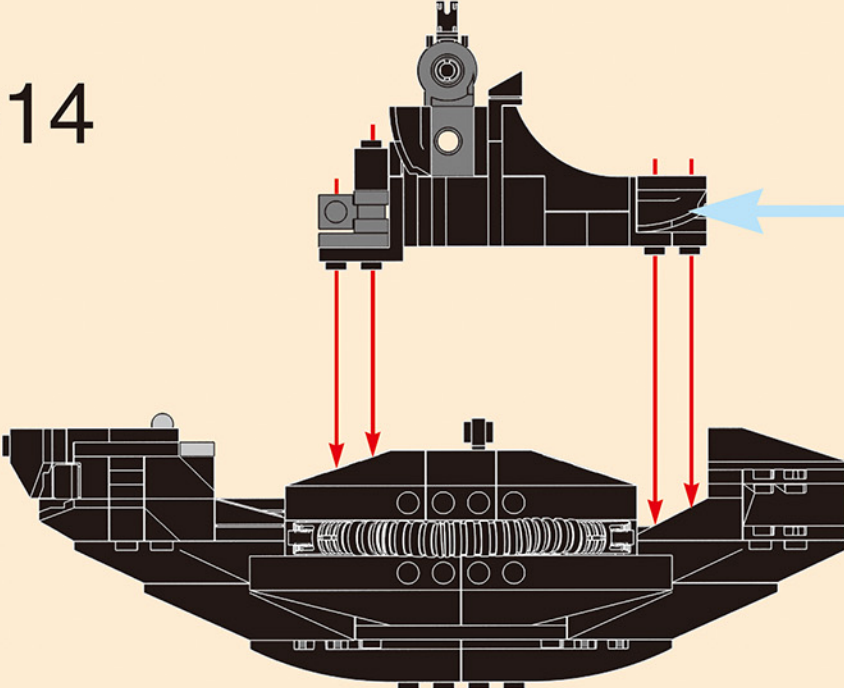

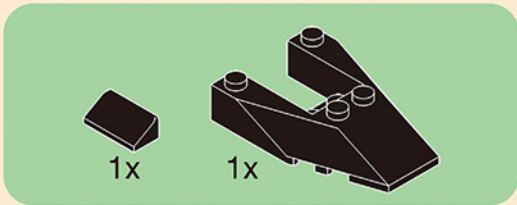

4-15.1

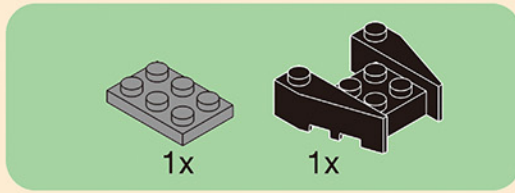
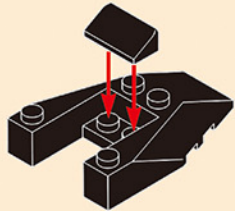

4-15.2

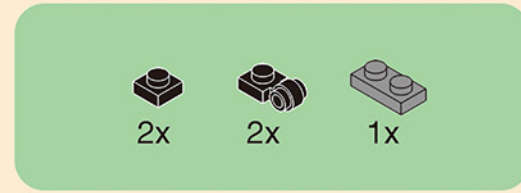
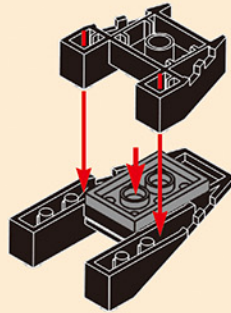

4-15.3

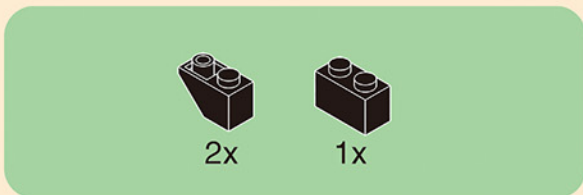
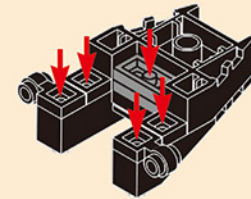

4-15.4

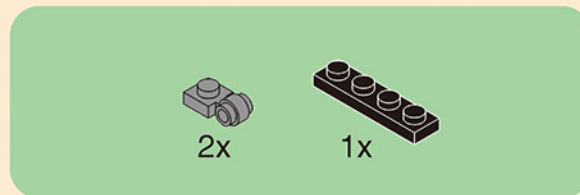
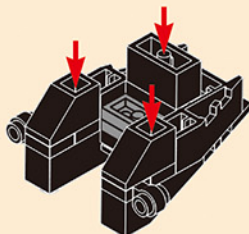

4-15.5

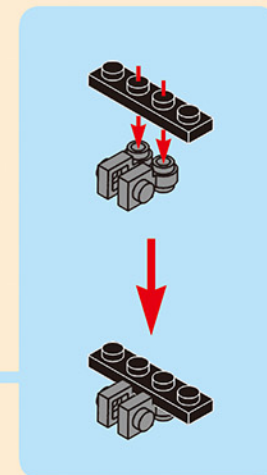
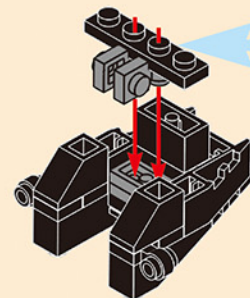

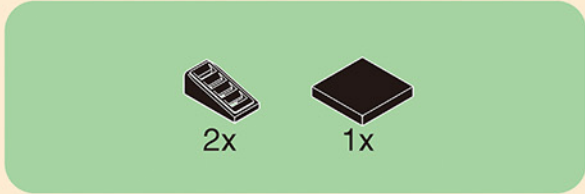

4-15.6

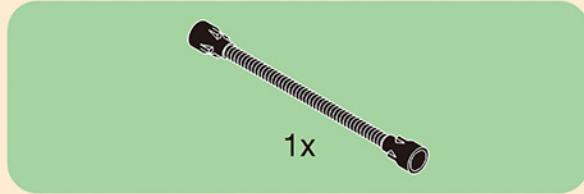

4-15

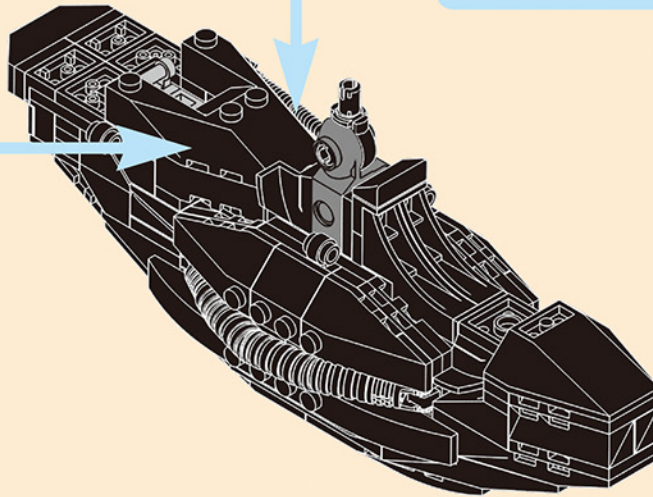
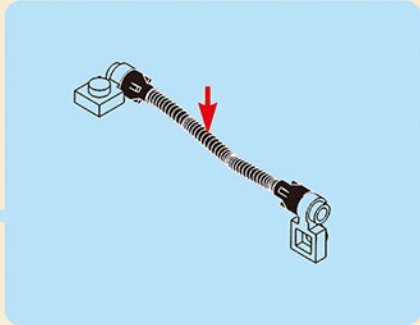
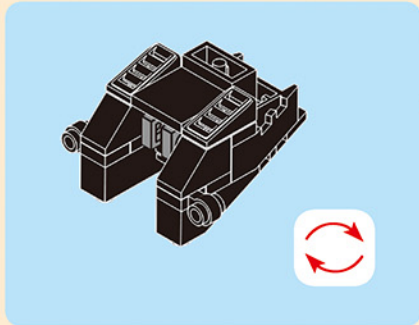
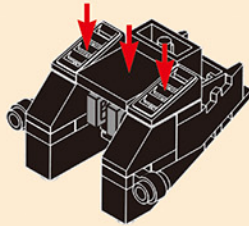

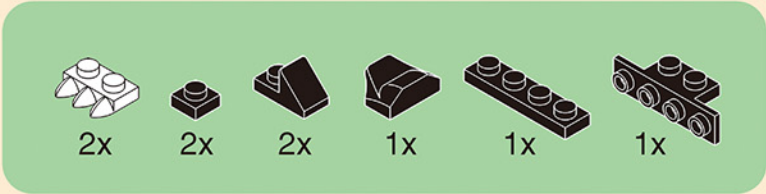

4-16.1

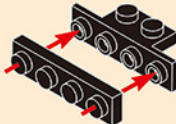

4-16.2

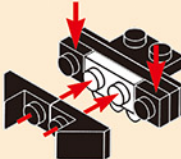

4-16.3

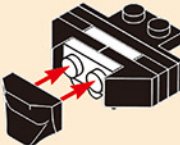

4-16

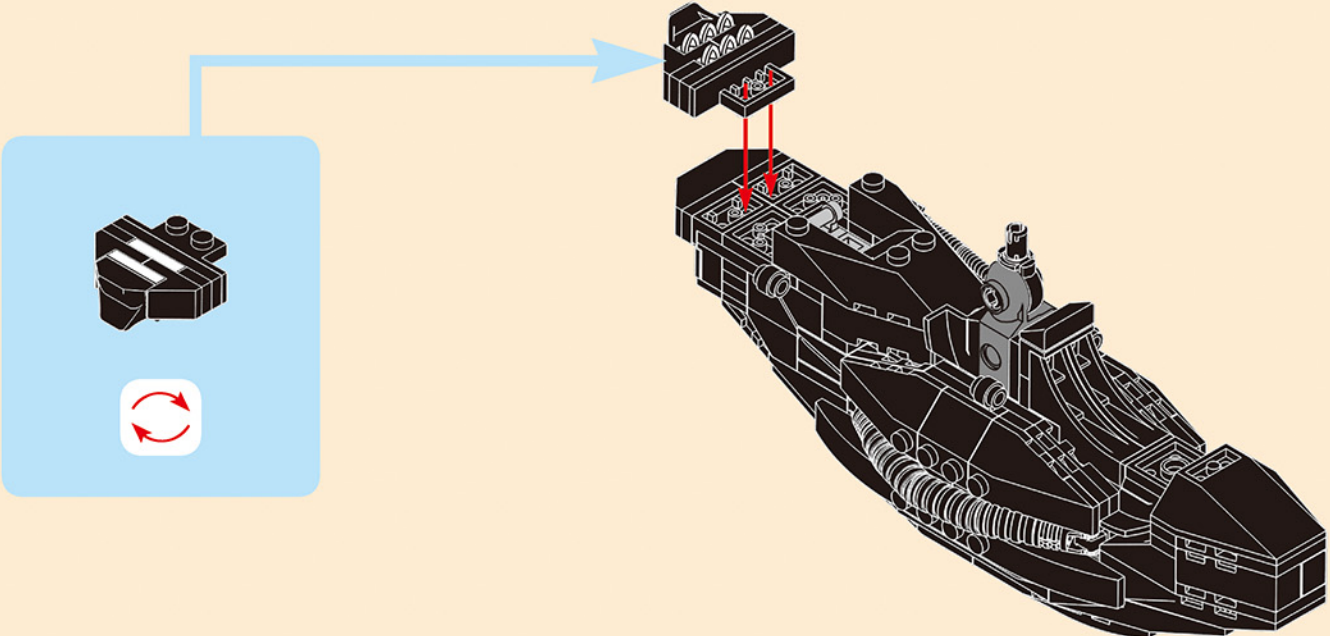

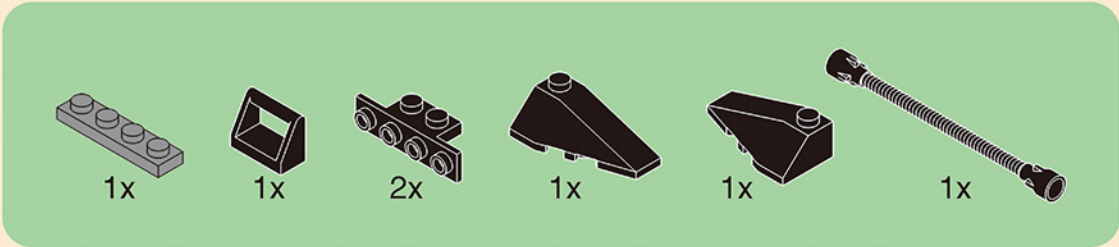

4-17

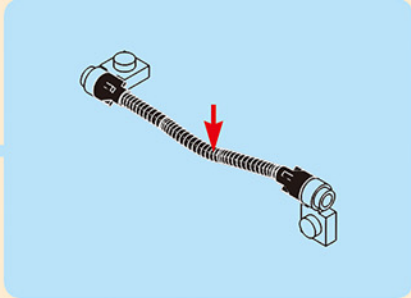
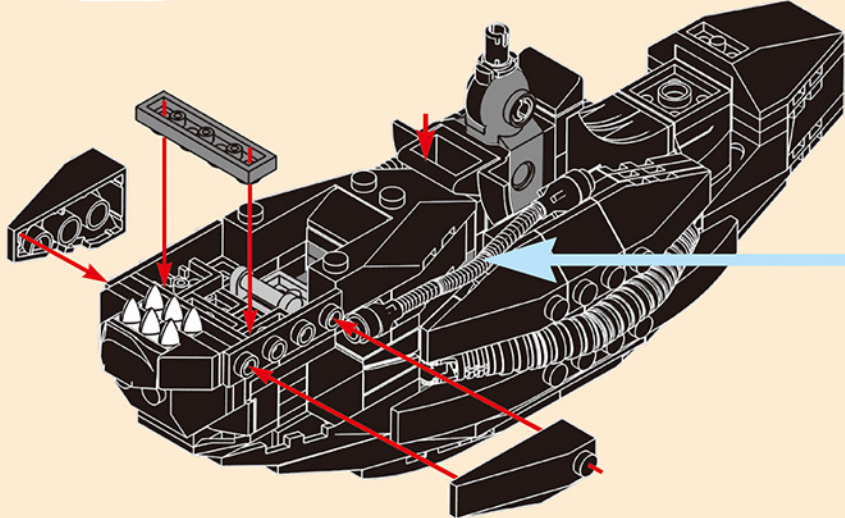

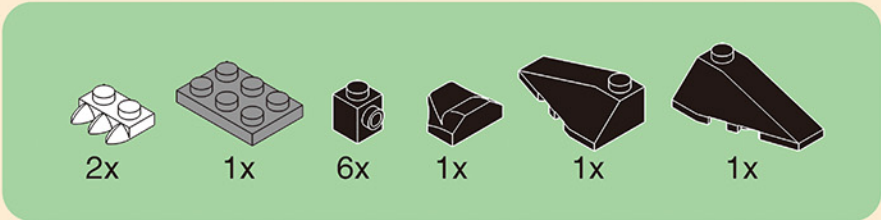

4-18.1

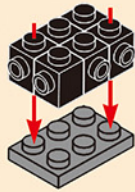

4-18.2

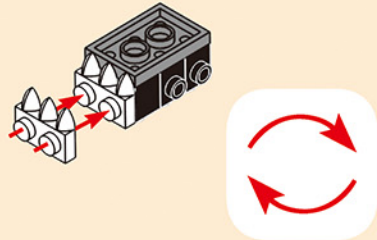

4-18.3

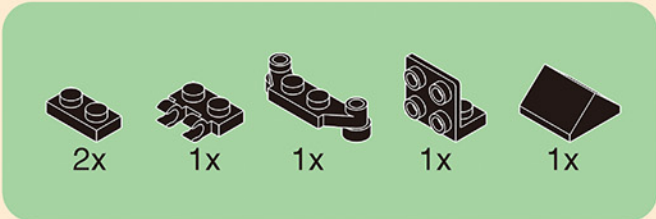
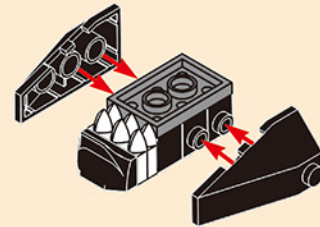

4-18.4

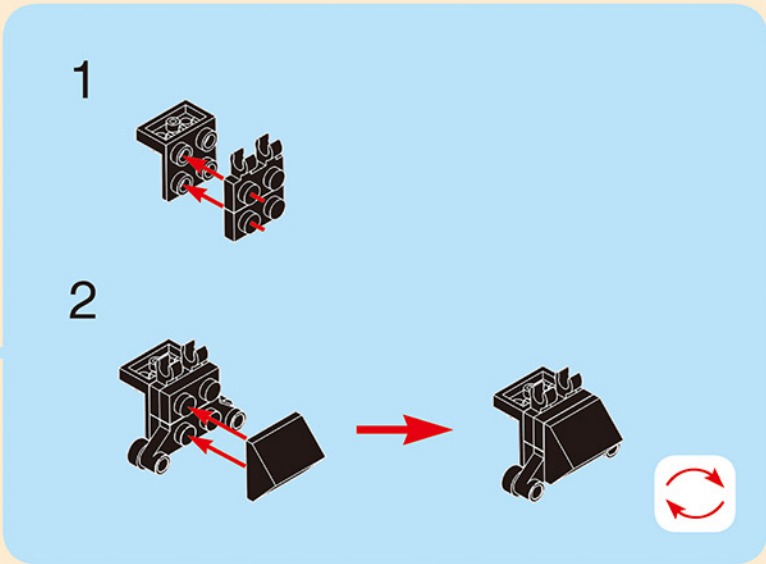
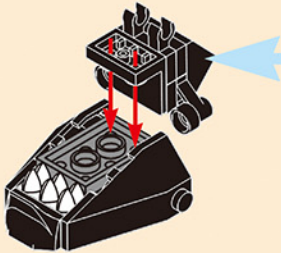

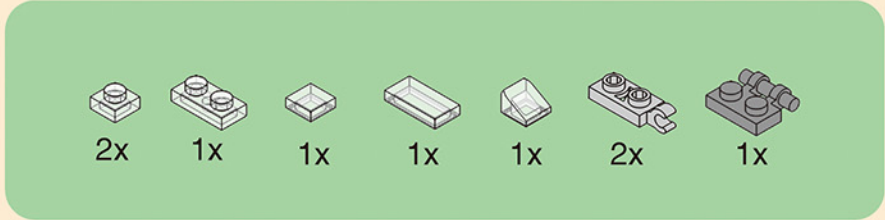

4-18.5

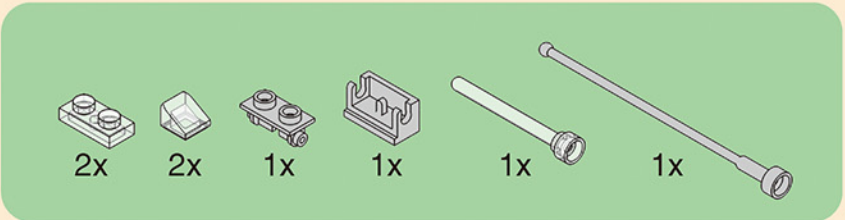
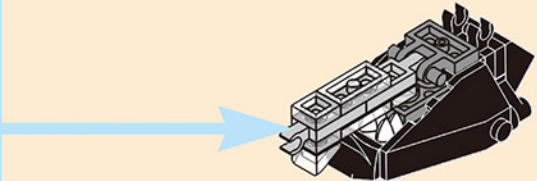
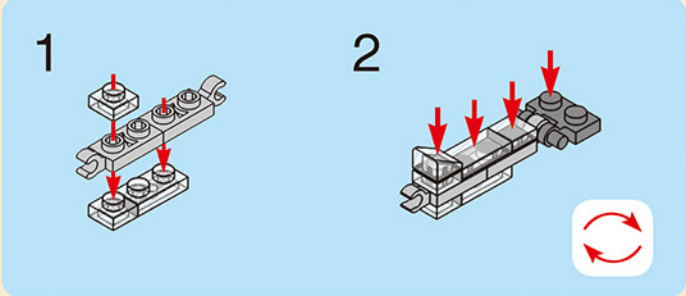

4-18.6

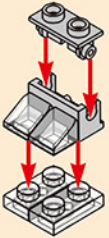

4-18.7

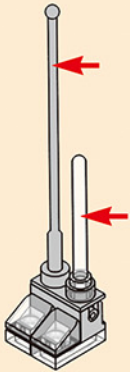

4-18

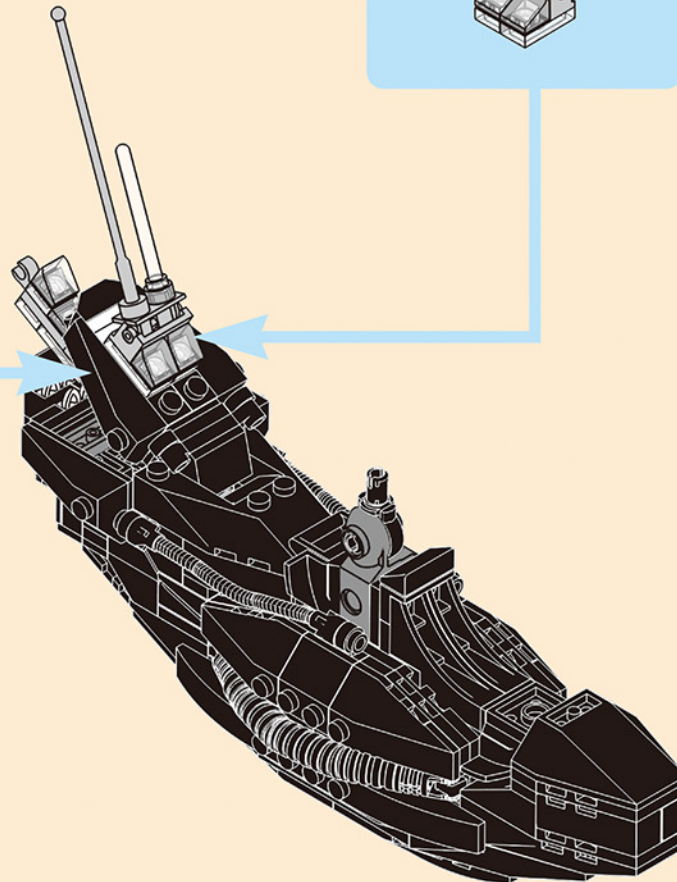
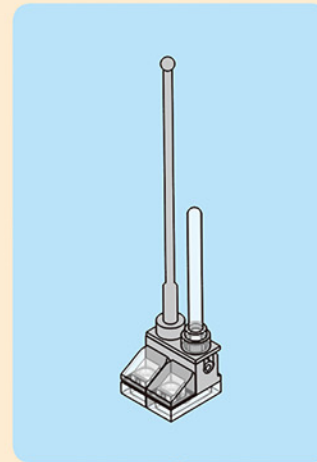
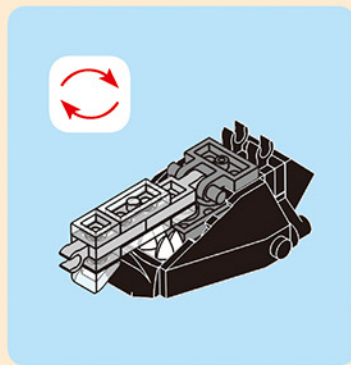

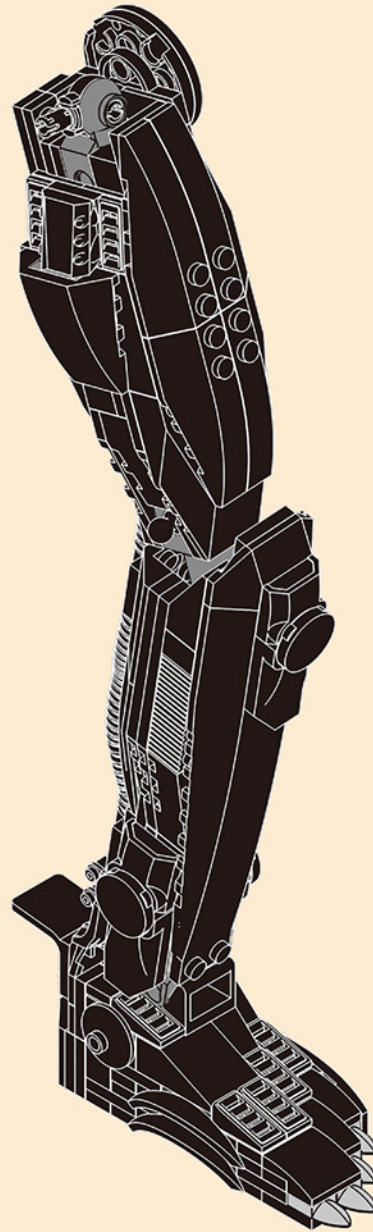

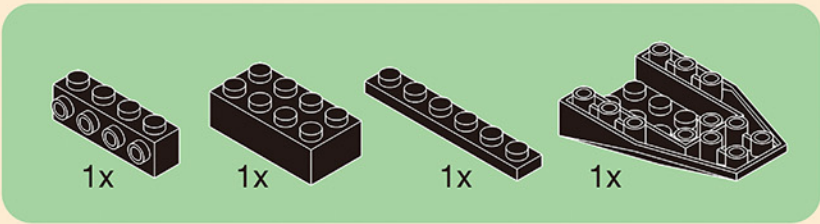

5-1

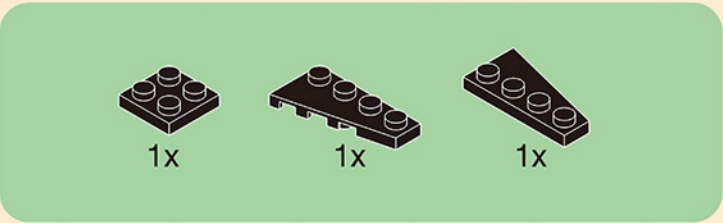
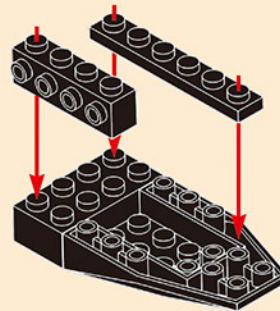

5-2

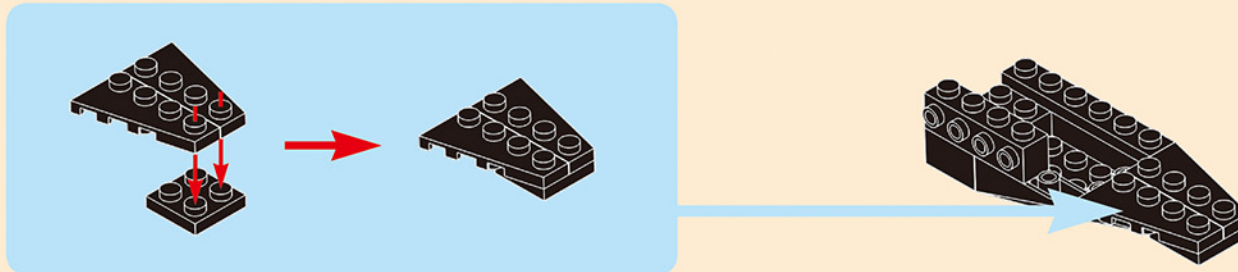

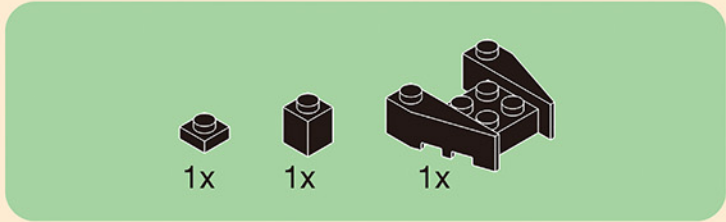

5-3

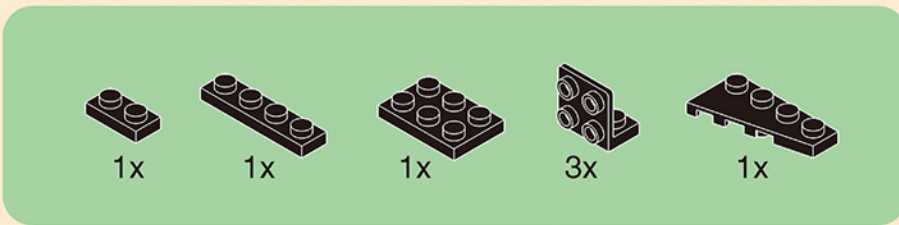
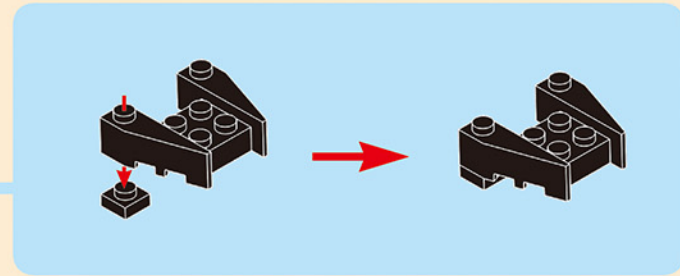
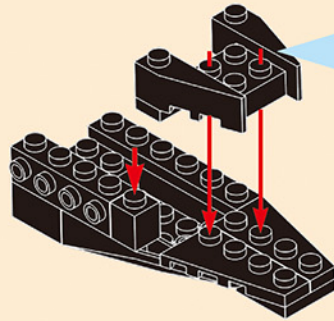

5-4.1

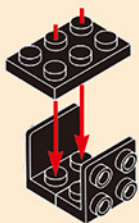

5-4.2

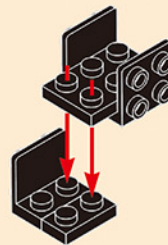

5-4.3

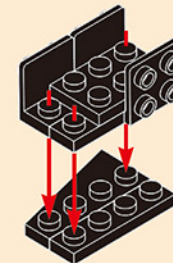

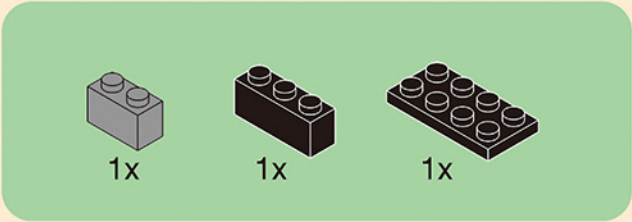

5-4.4

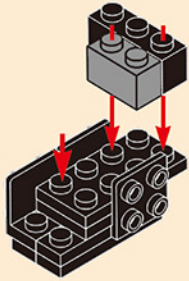

5-4

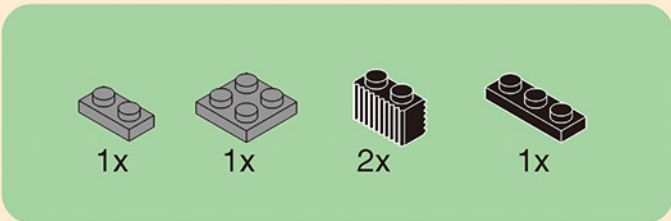
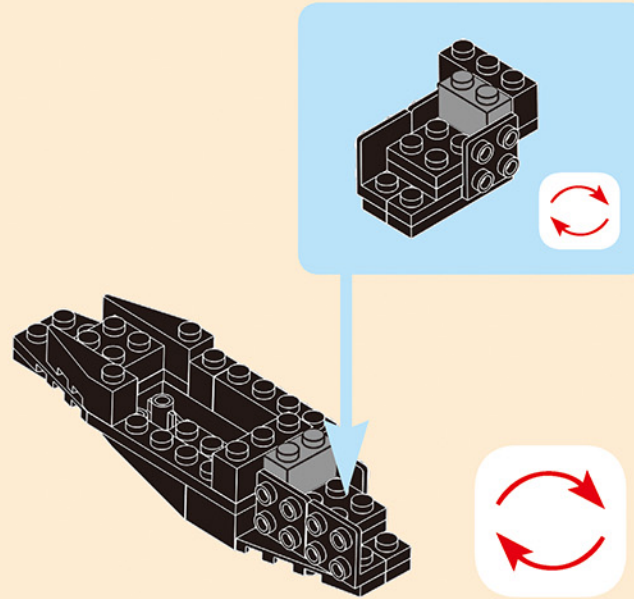

5-5

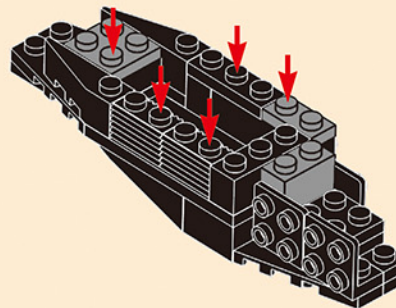

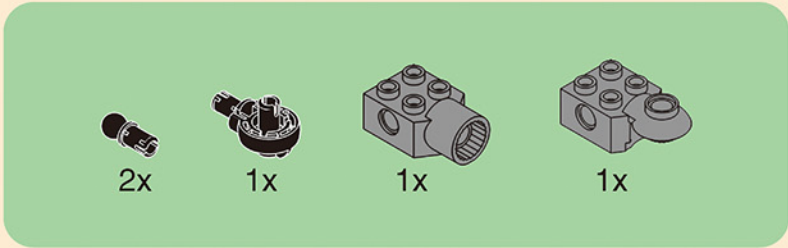

5-6

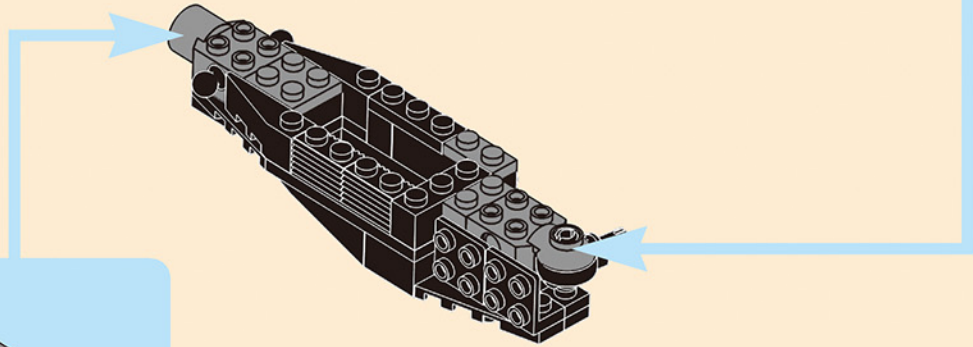
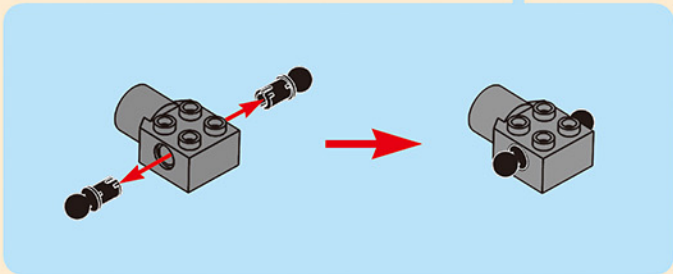
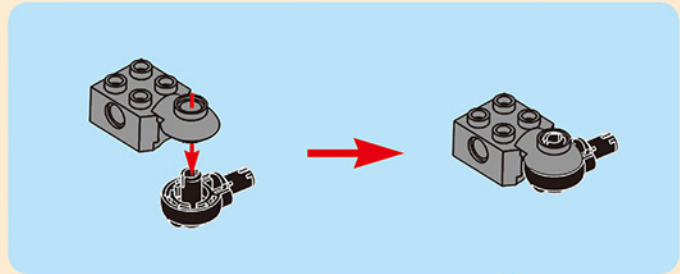

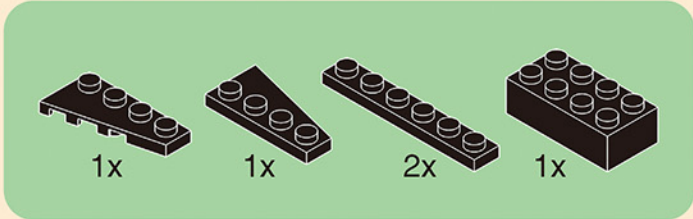

5-7

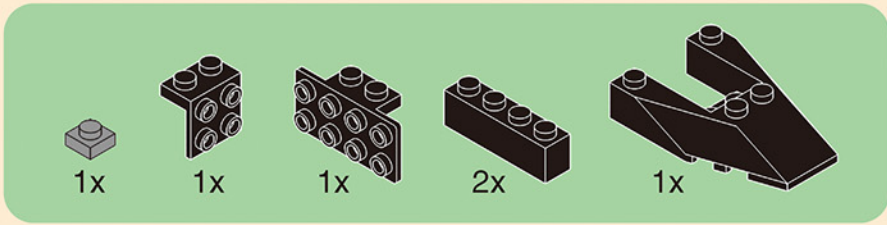
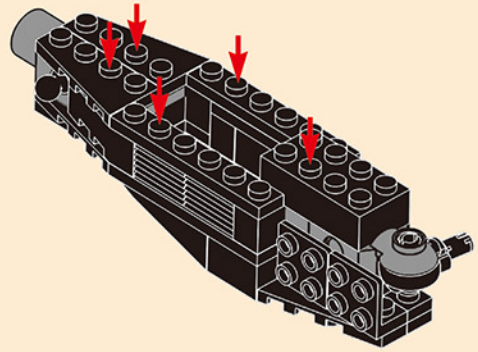

5-8

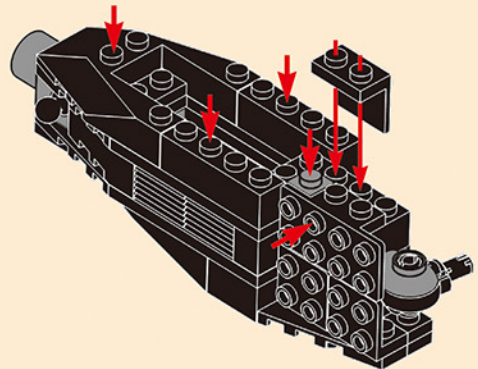

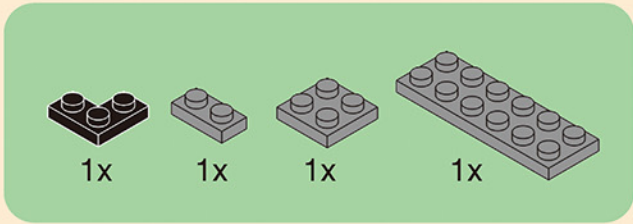

5-9

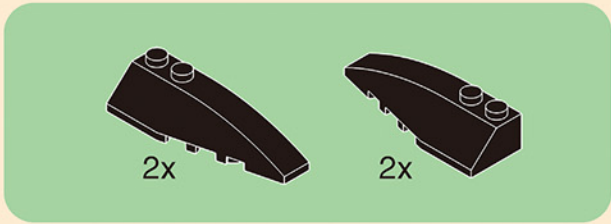
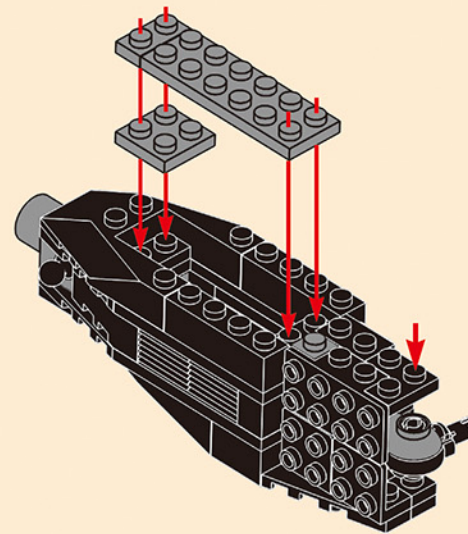

5-10

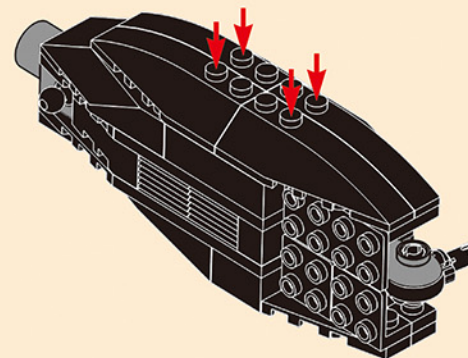



5-11

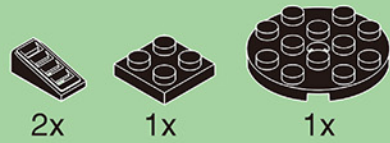
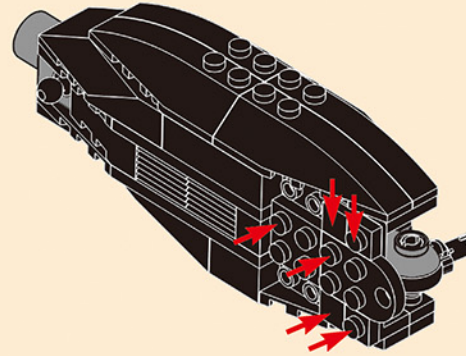

5-12

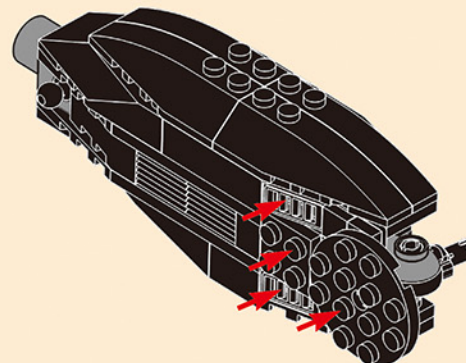

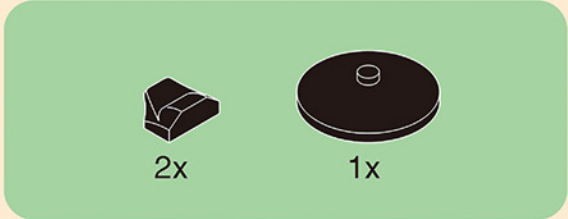

5-13

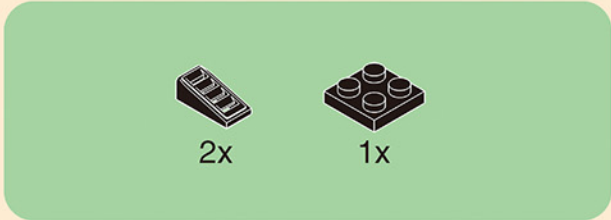
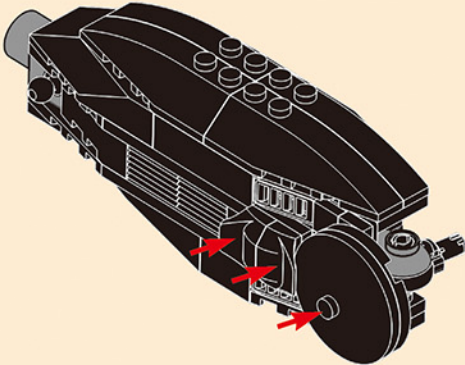

5-14

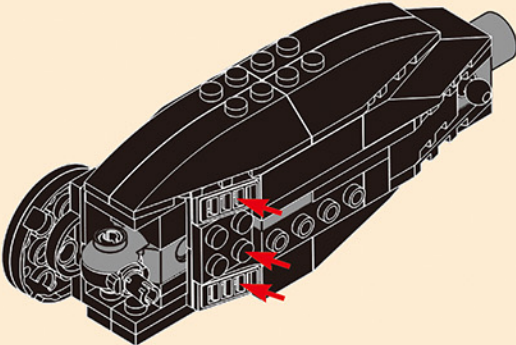

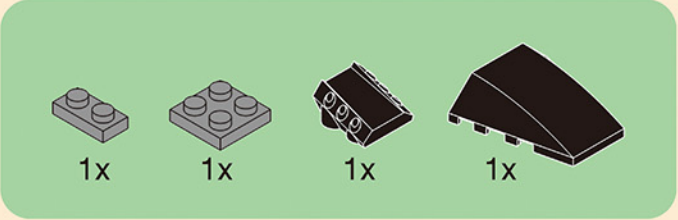

5-15

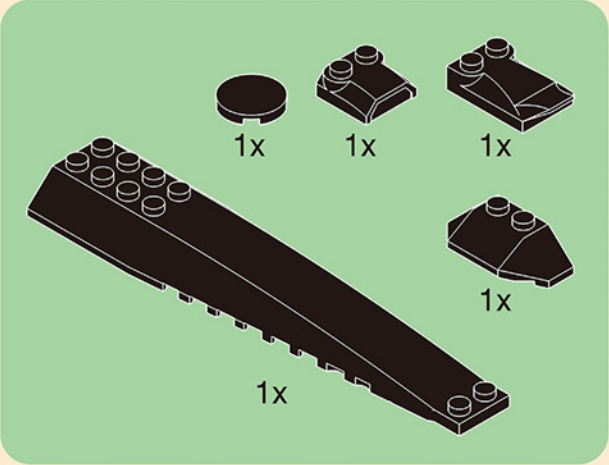
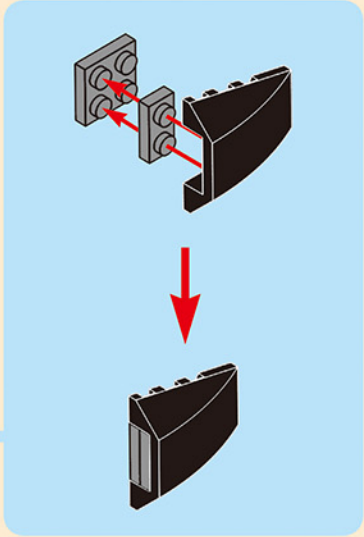
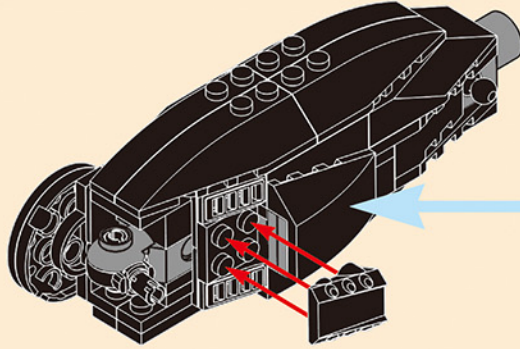

5-16

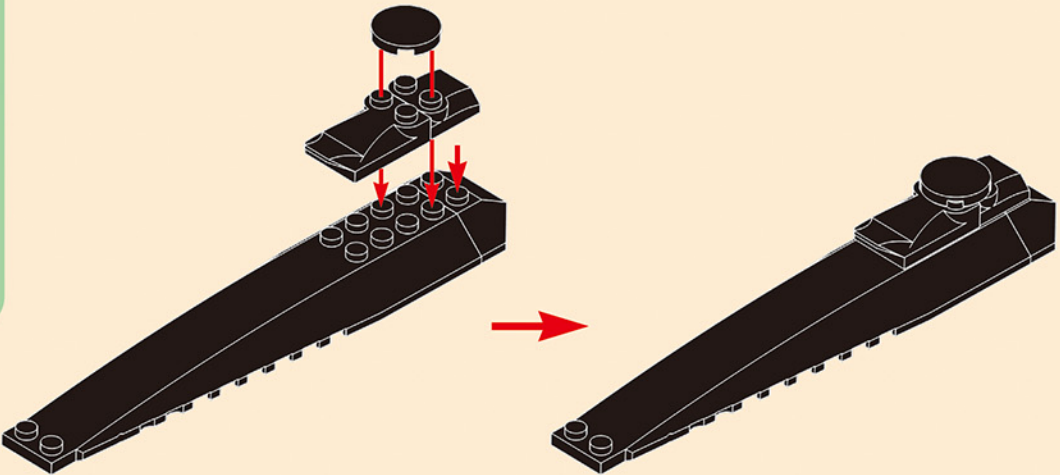

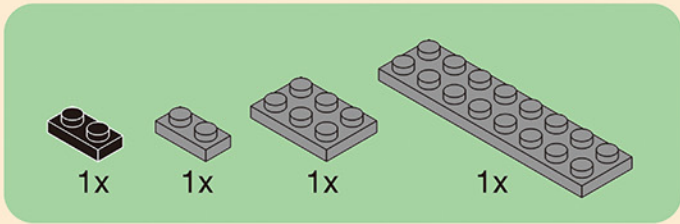

5-17

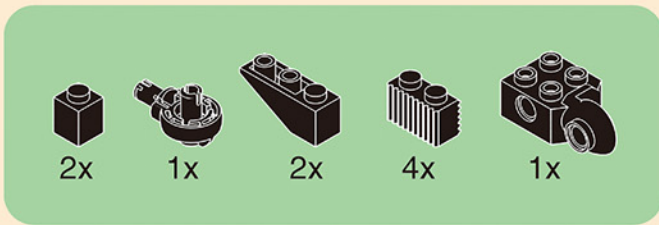
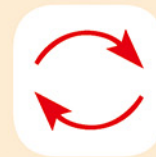
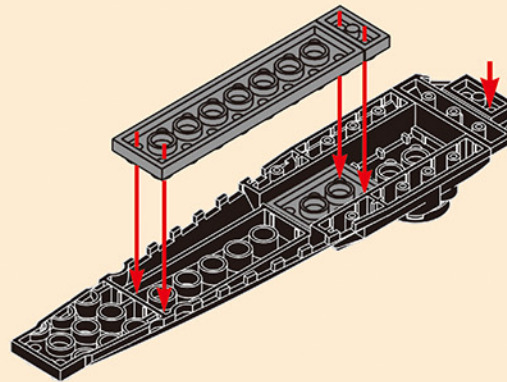

5-18

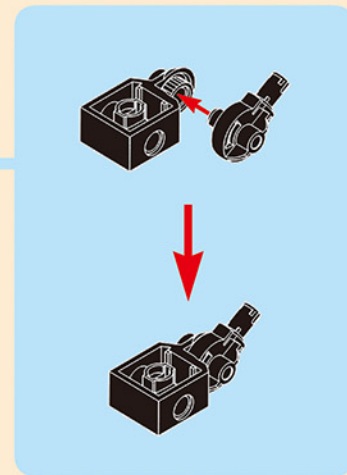
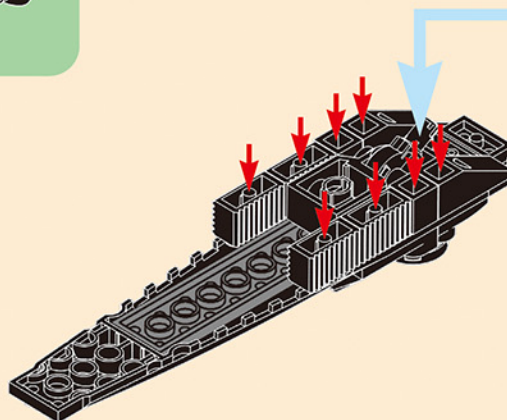

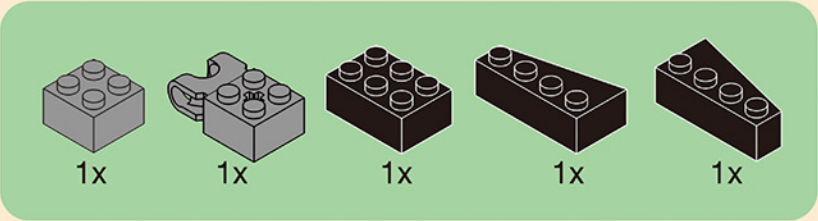

5-19

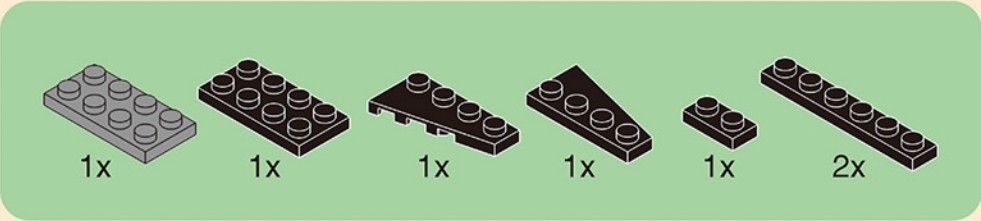
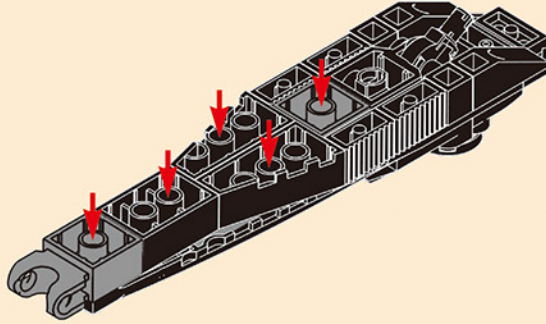

5-20

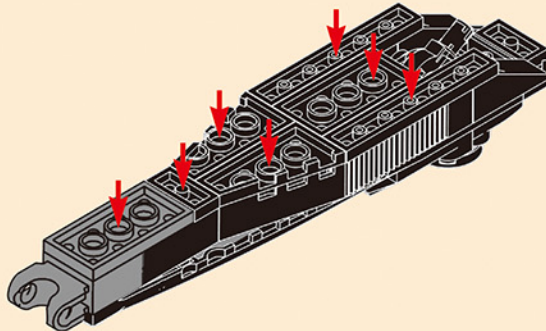

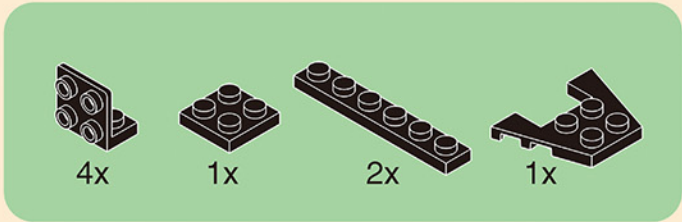

5-21

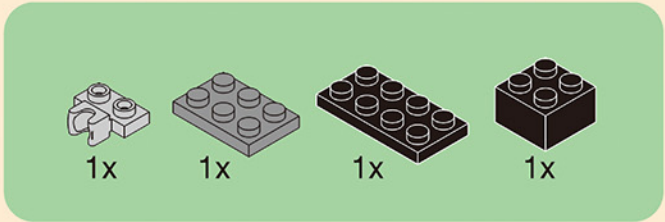
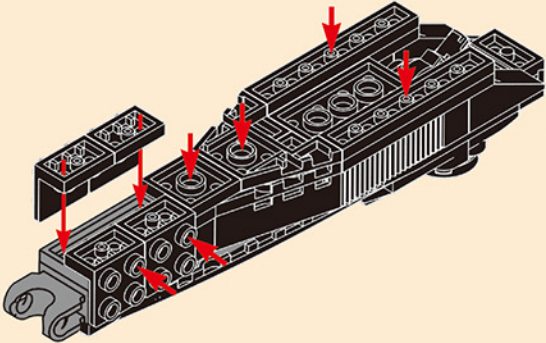

5-22

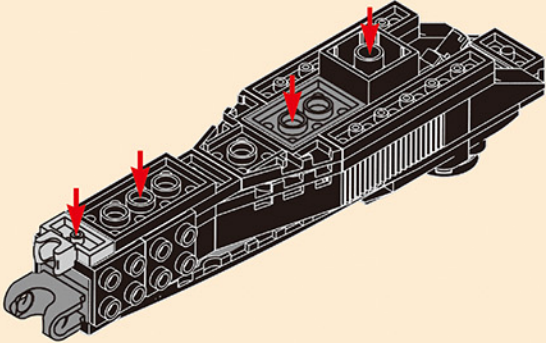

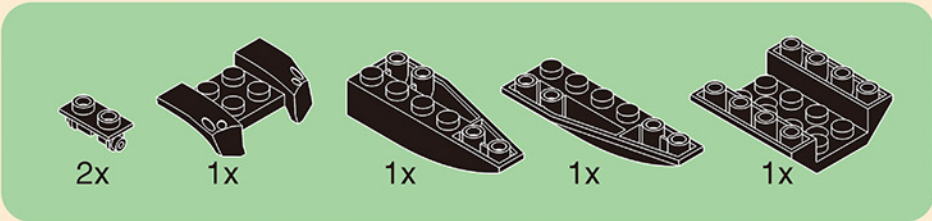

5-23

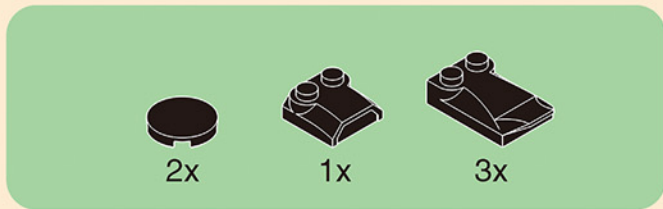
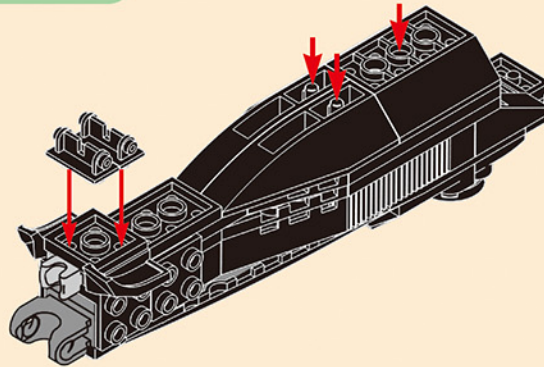

5-24

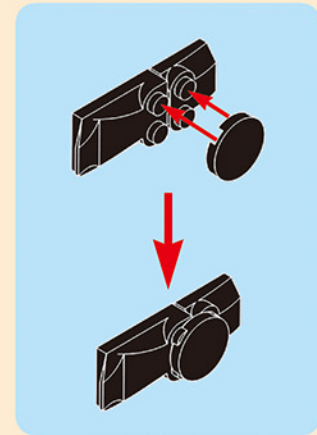
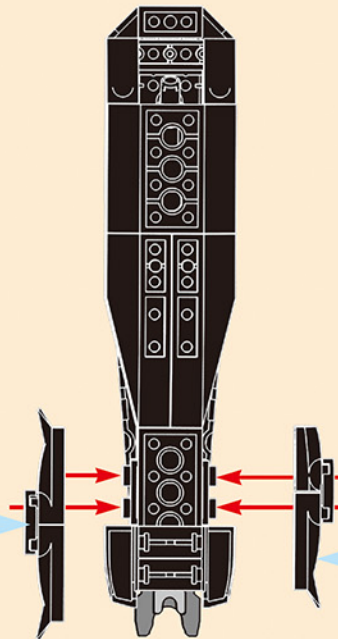
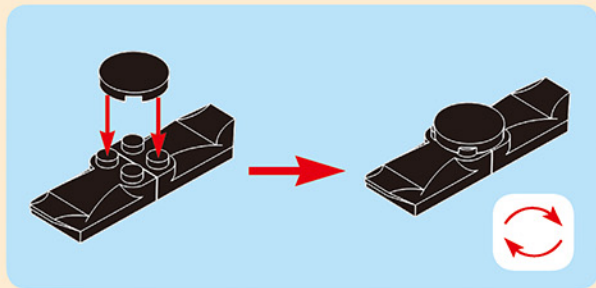

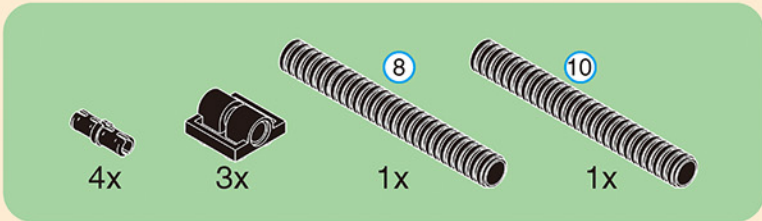
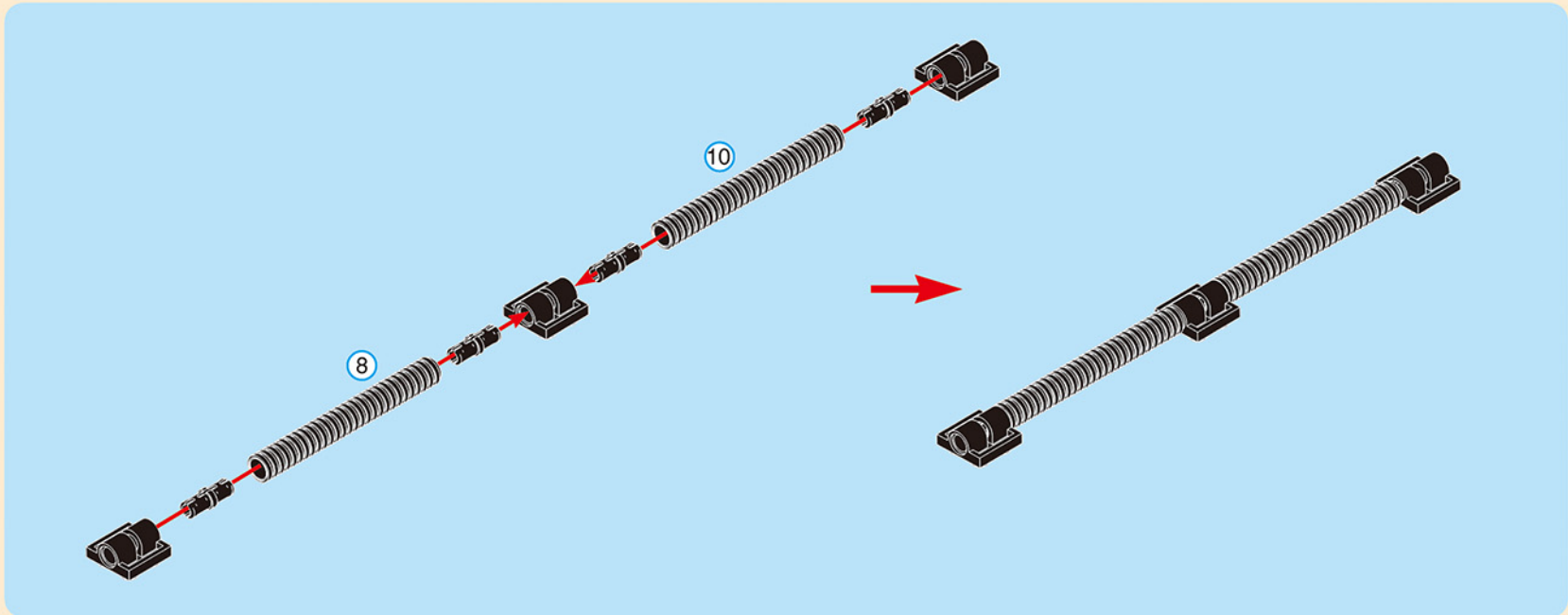

5-25

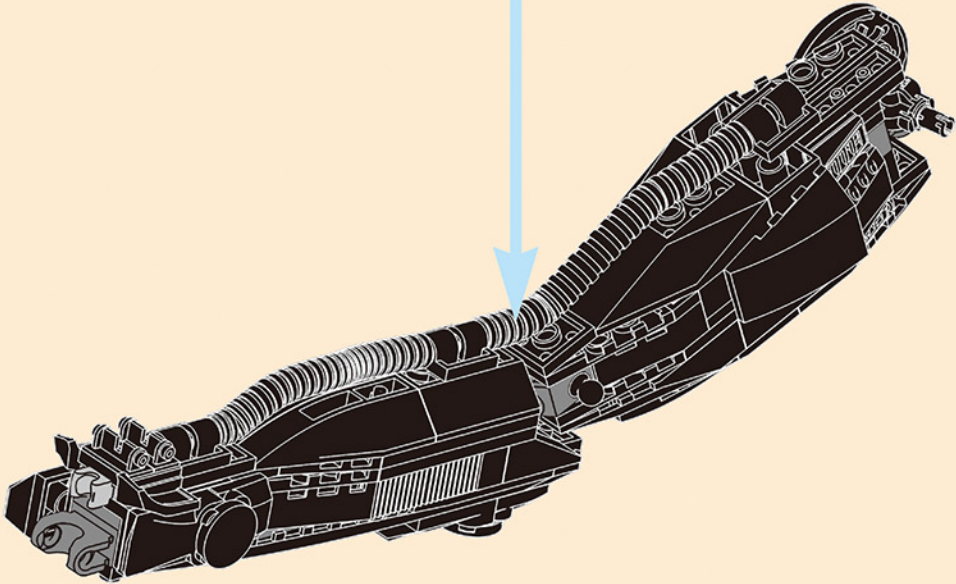

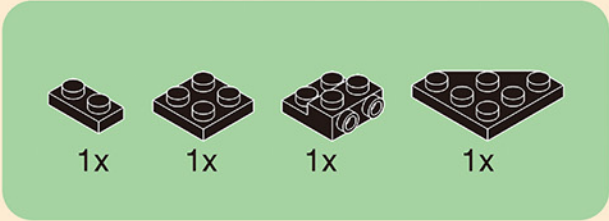

5-26.1

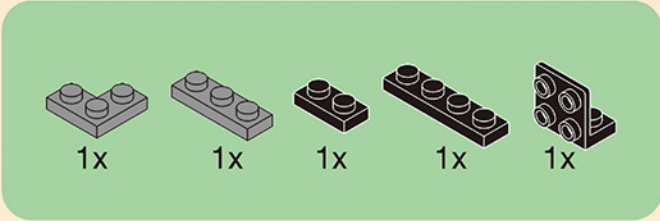
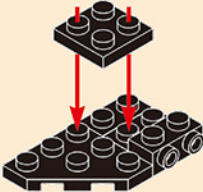

5-26.2

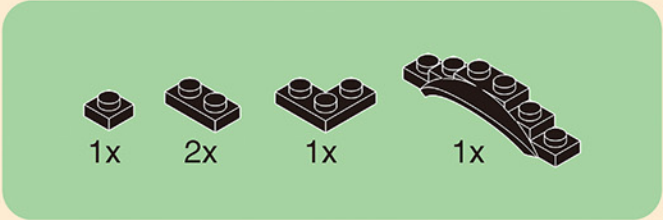
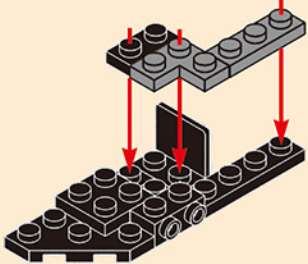

5-26.3

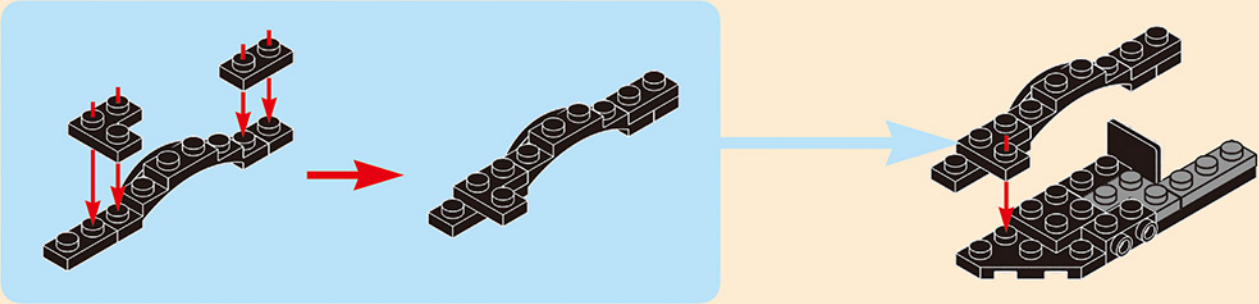

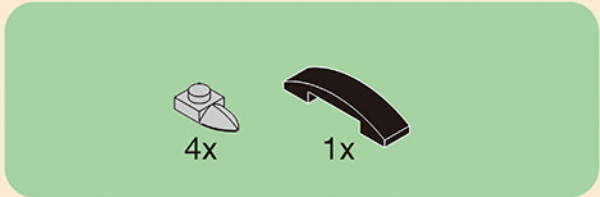

5-26.4

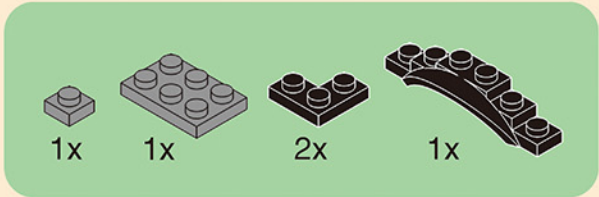
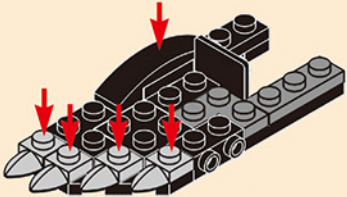

5-26.5

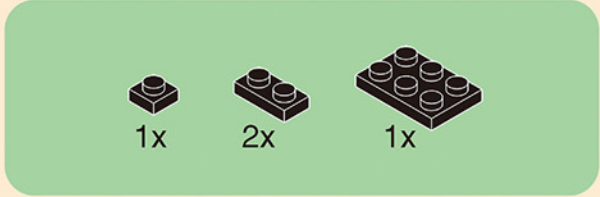
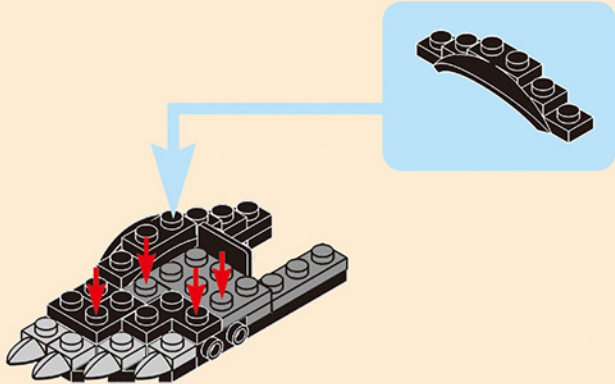

5-26.6

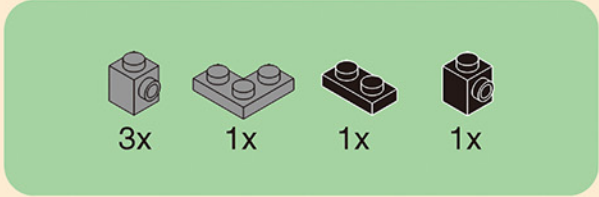
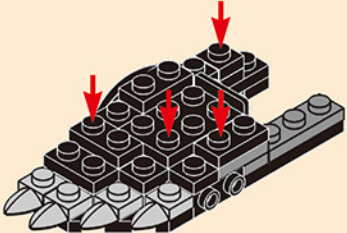

5-26.7

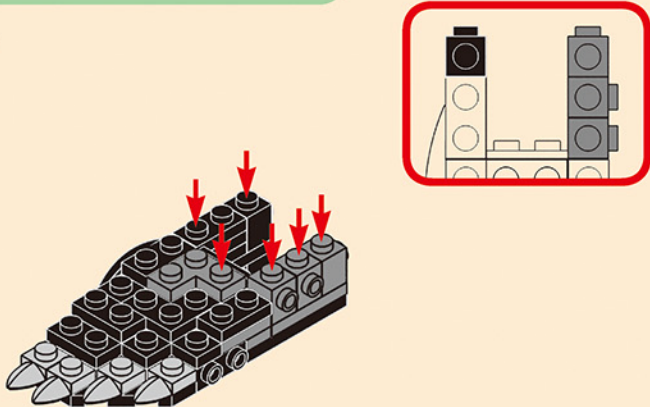



4x



2x



1x

5-26.8

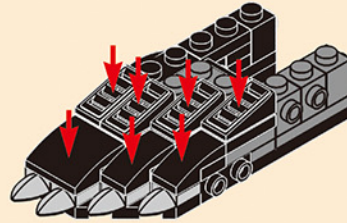

1x



1x



1x



1x



1x

5-26.9

1



2

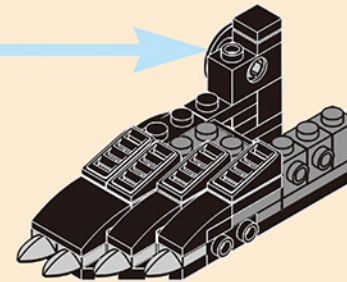
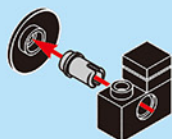

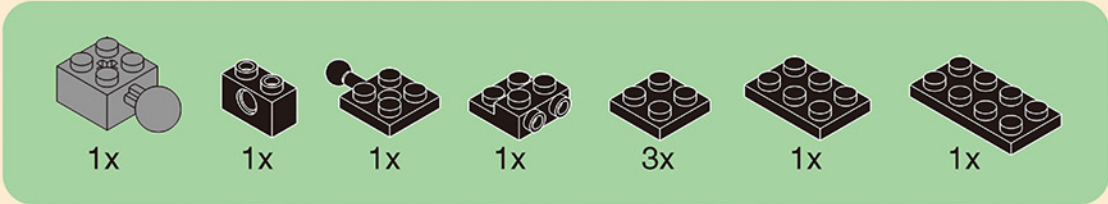

5-26.10.1

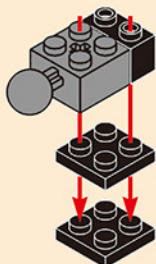

5-26.10.2

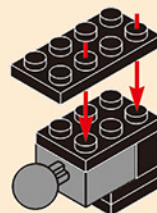

5-26.10.3

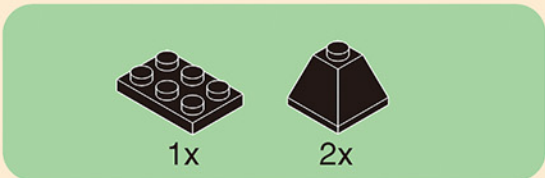
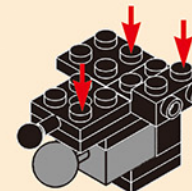

5-26.10.4

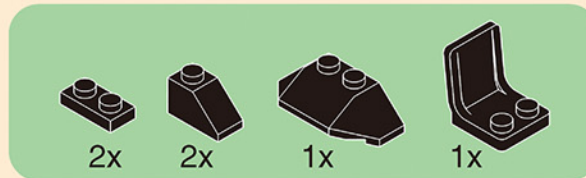
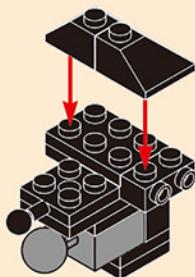

5-26.10.5

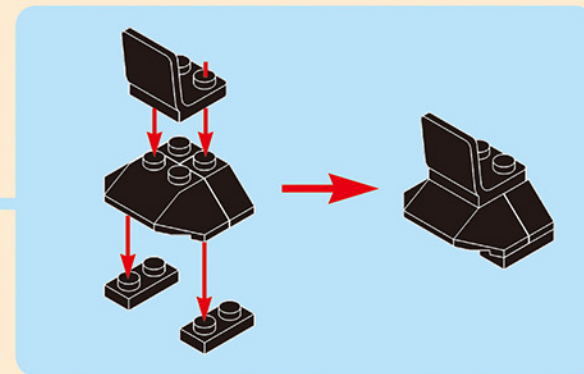
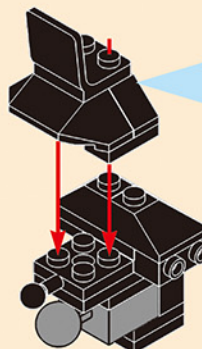

5-26.10

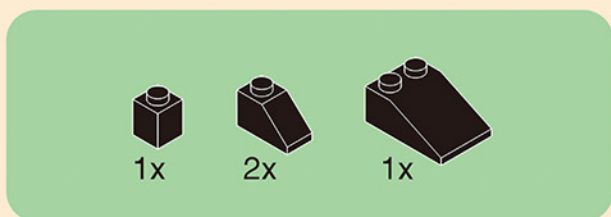
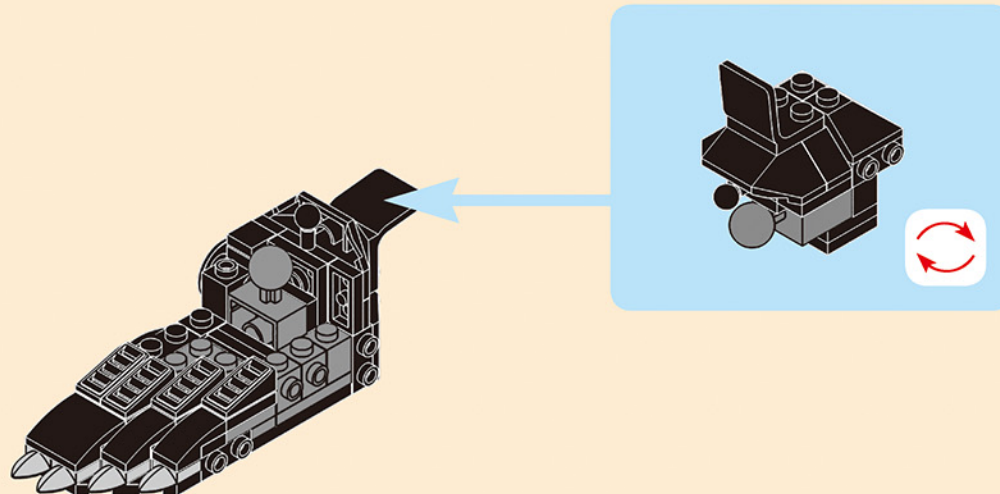

5-26.11

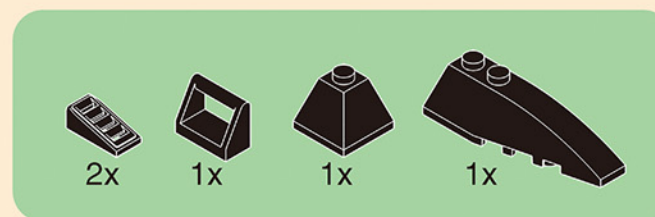
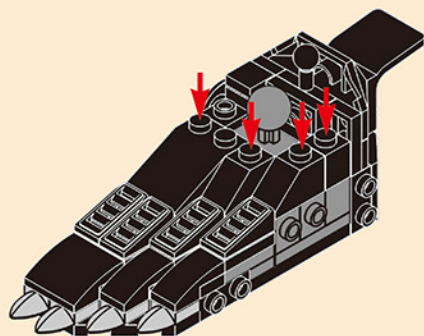

5-26.12

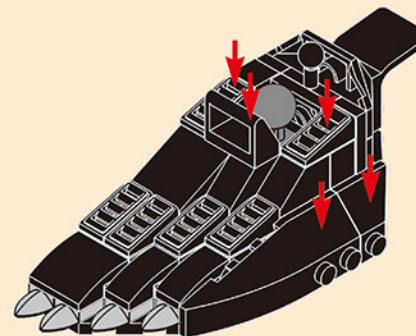

5-26.13

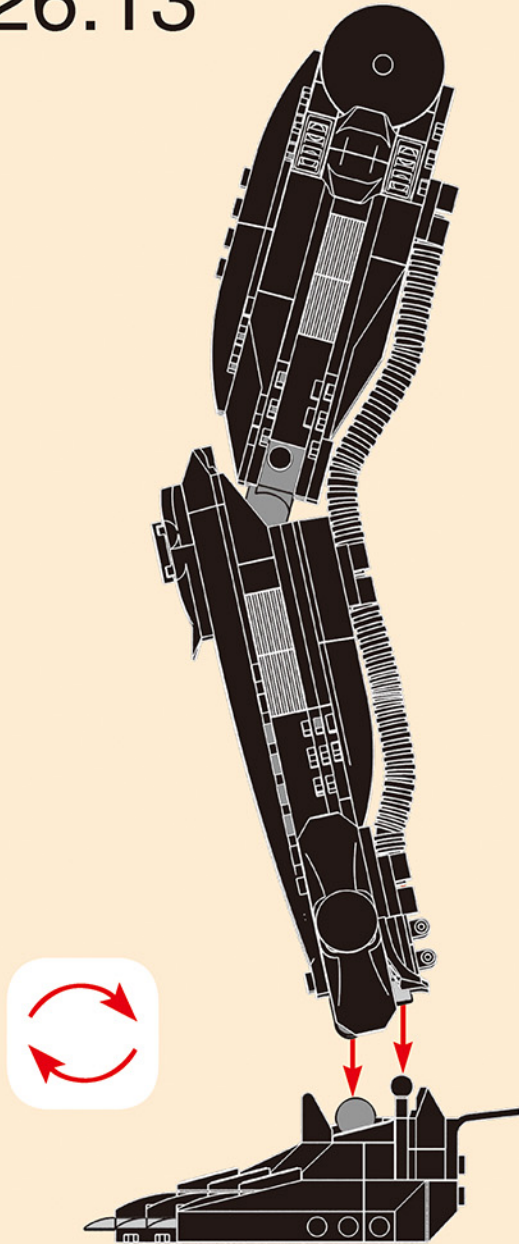

5-26

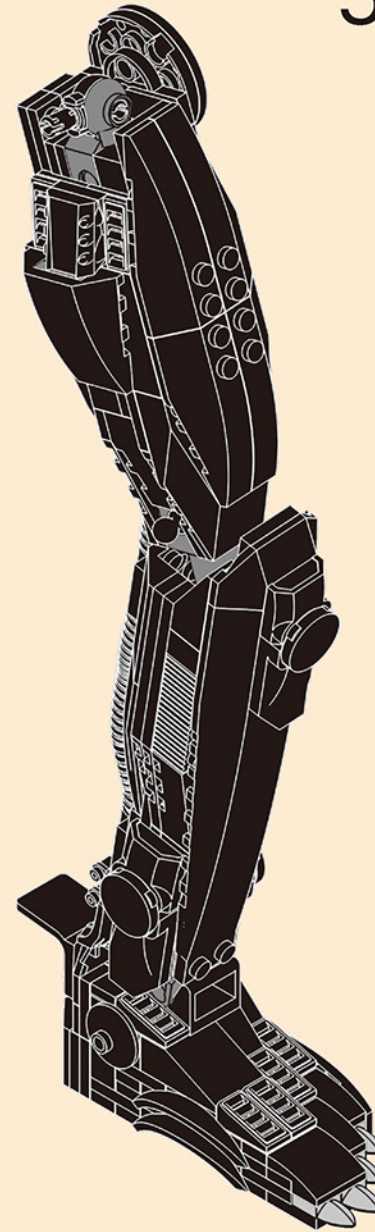

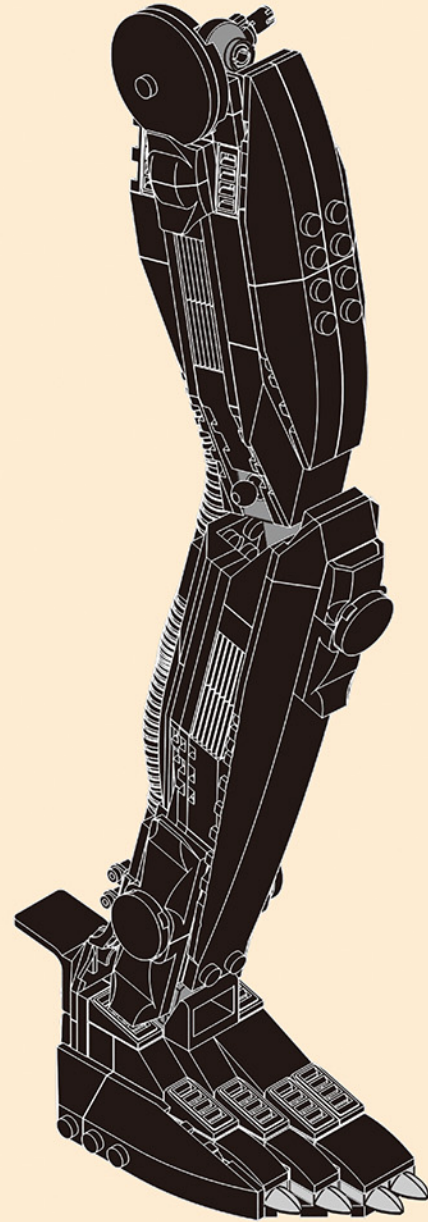

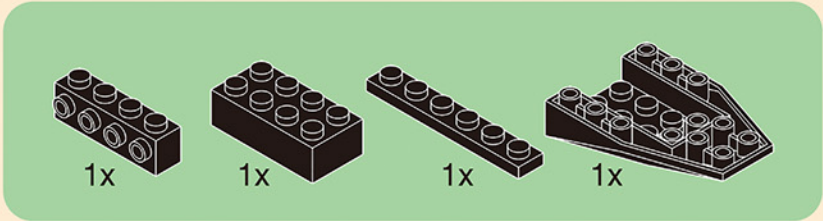

6-1

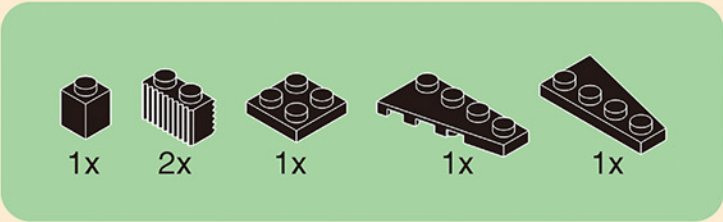
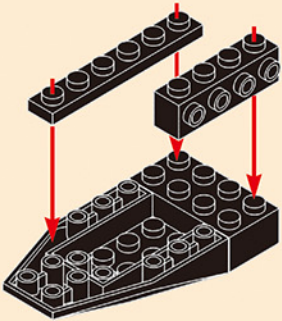

6-2

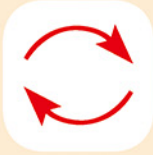
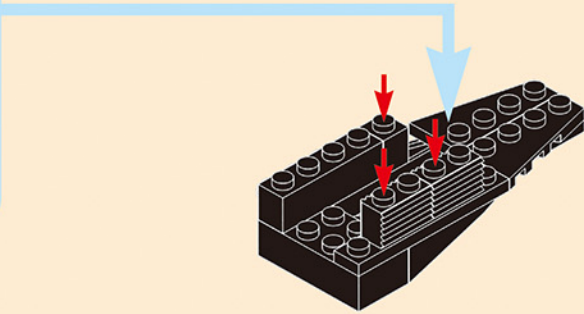
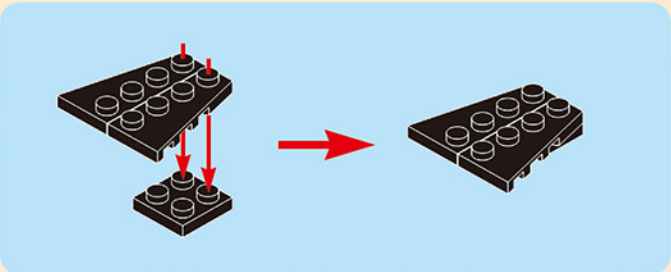

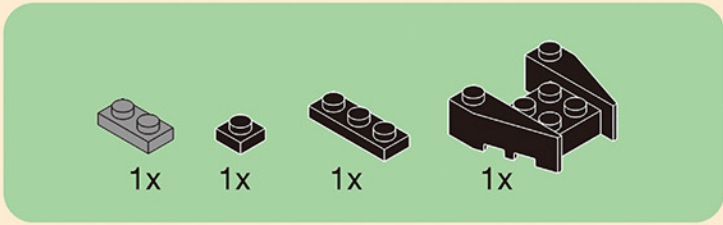

6-3

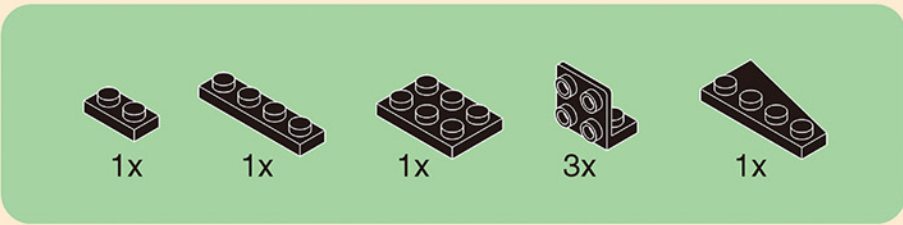
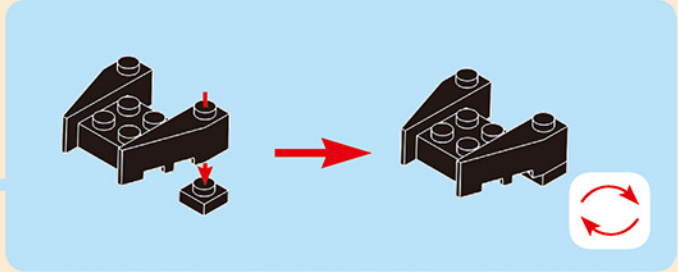
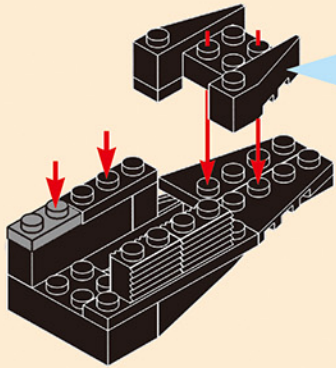

6-4.1

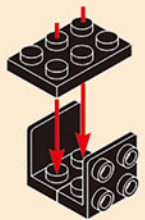

6-4.2

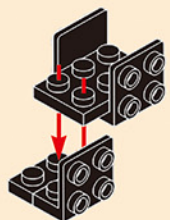

6-4.3

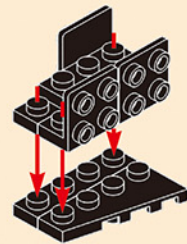

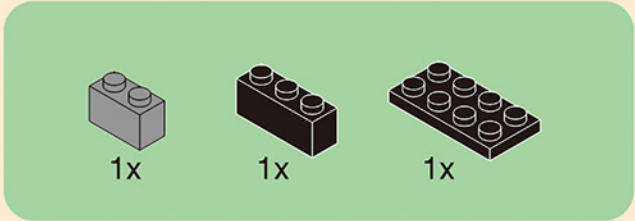

6-4.4

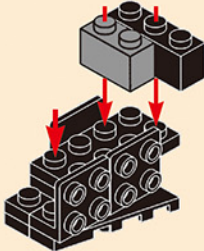

6-4

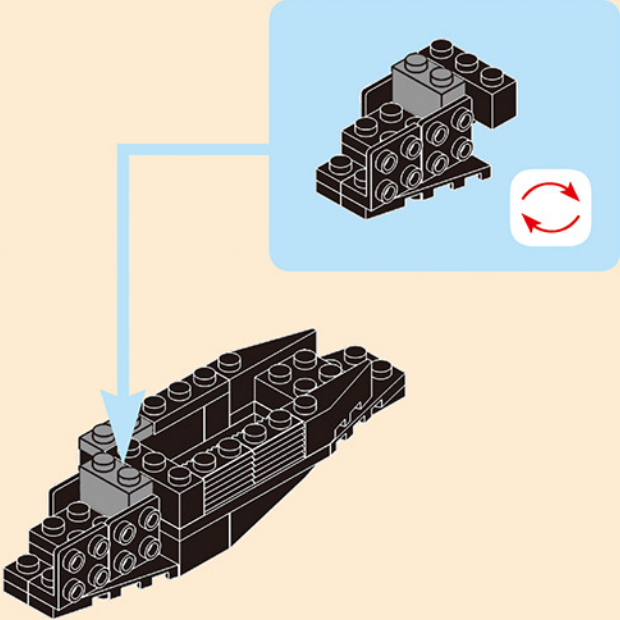

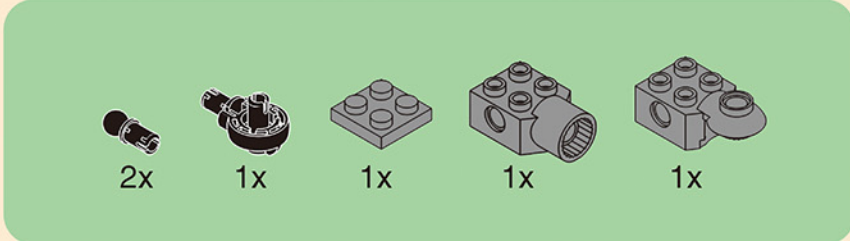

6-5

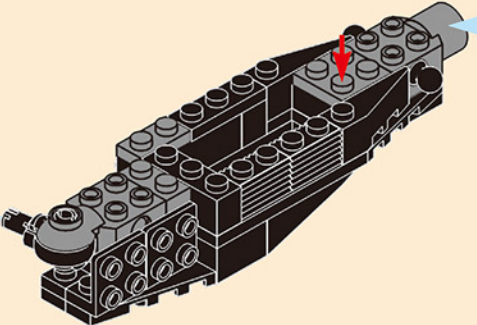
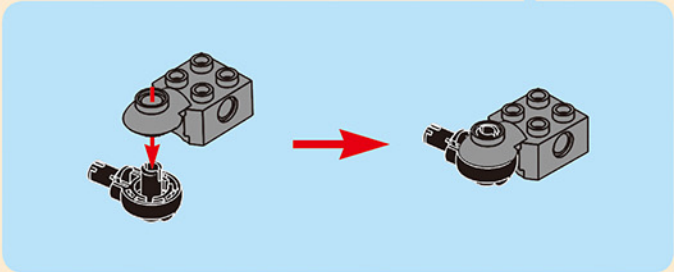
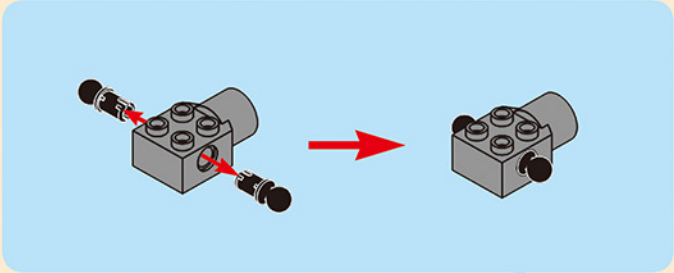

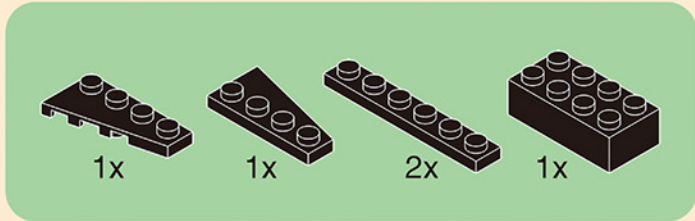

6-6

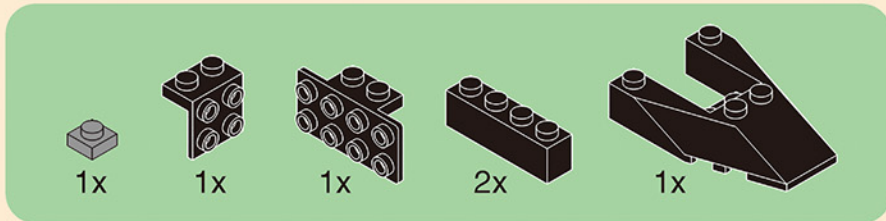
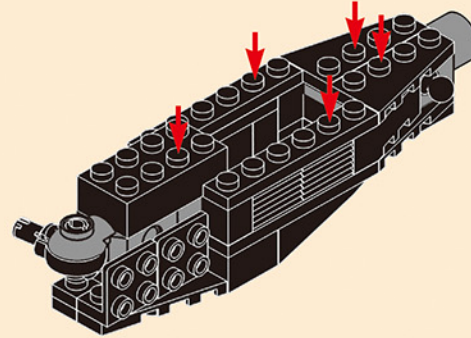

6-7

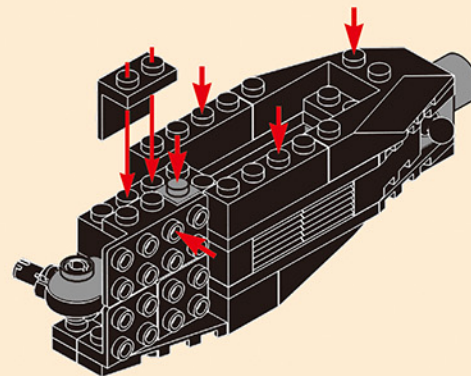

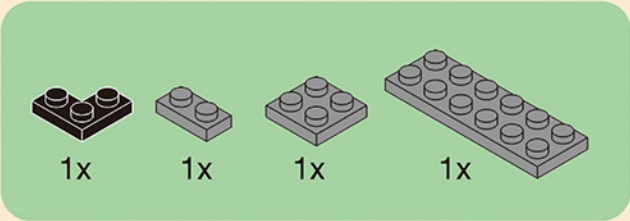

6-8

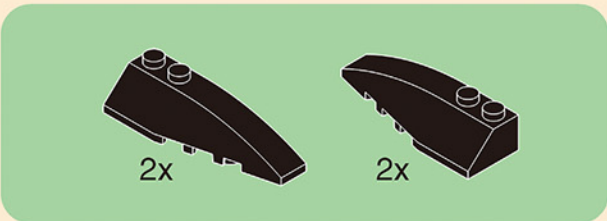
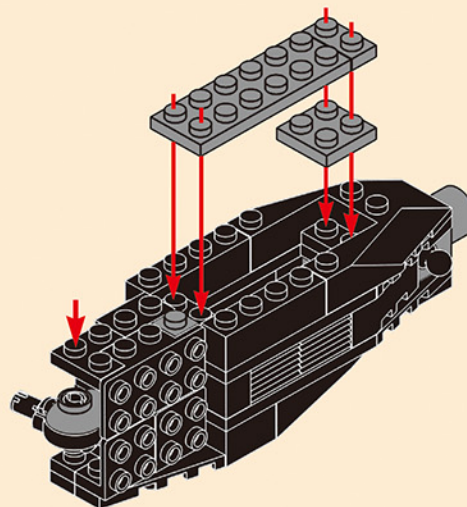

6-9

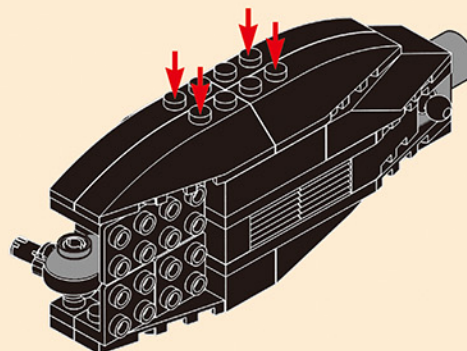

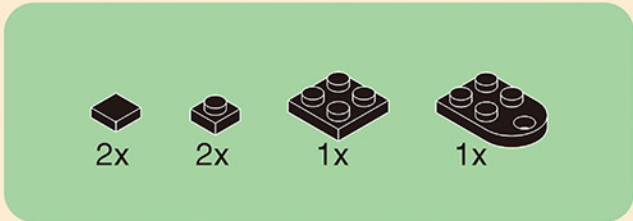

6-10

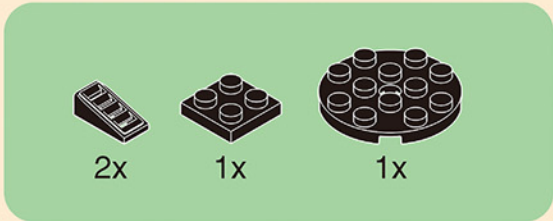
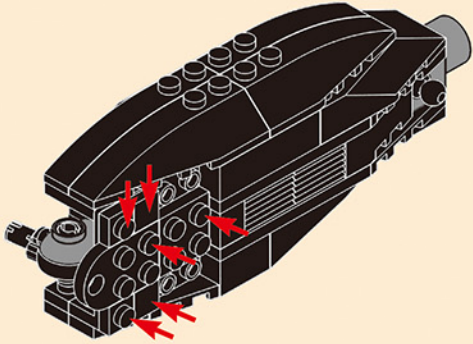

6-11

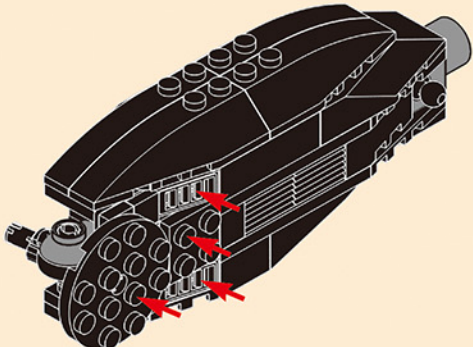

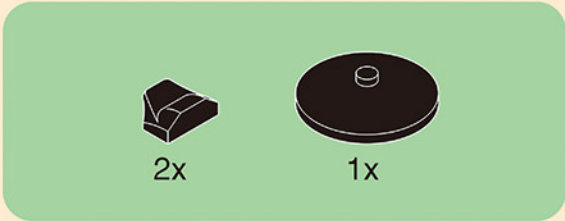

6-12

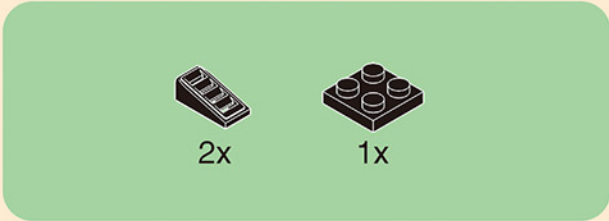
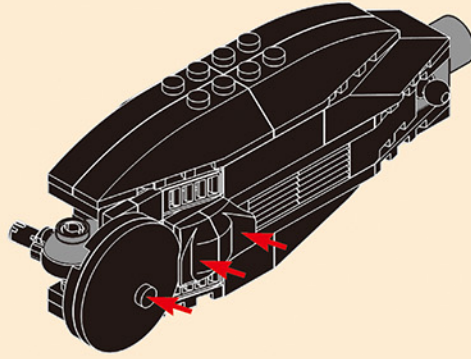

6-13

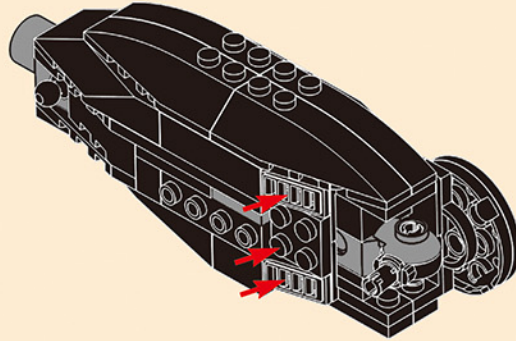

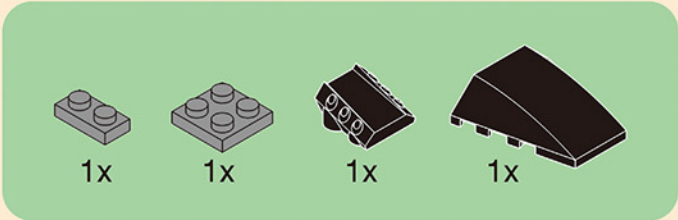

6-14

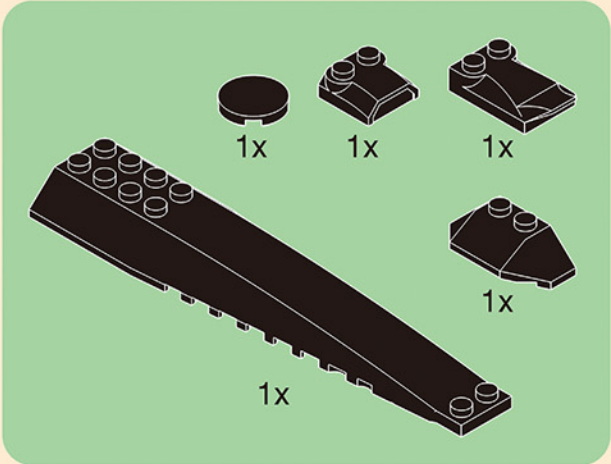
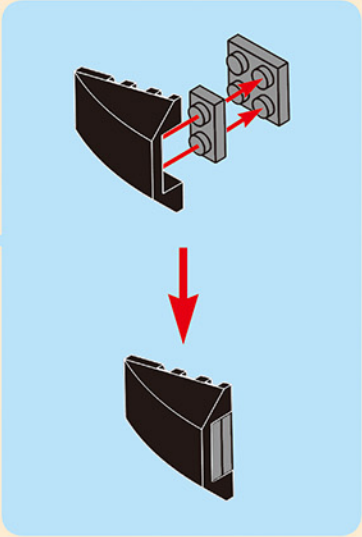
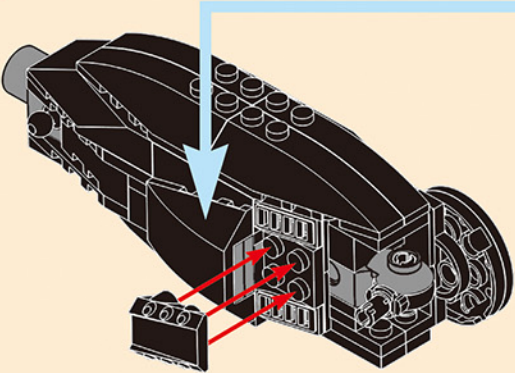

6-15

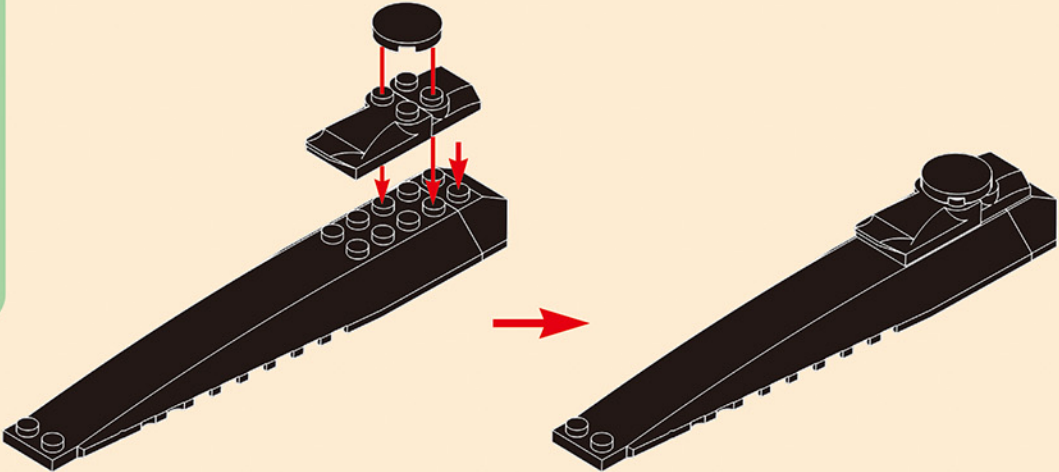

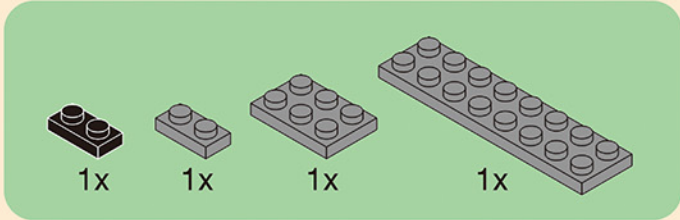

6-16

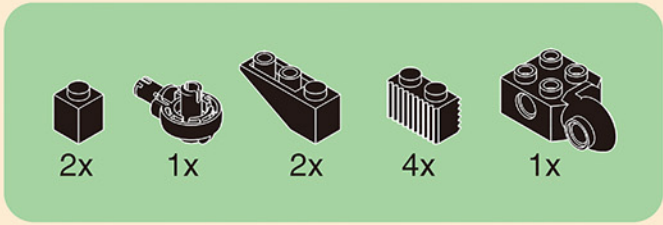
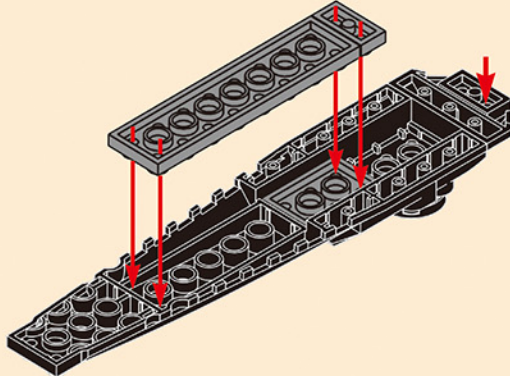

6-17

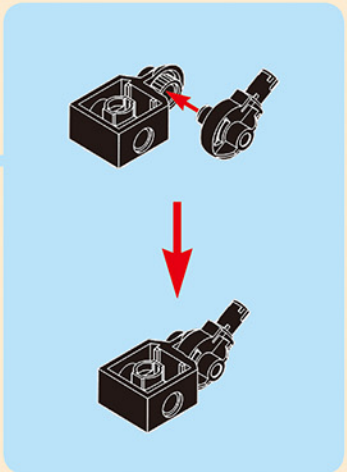
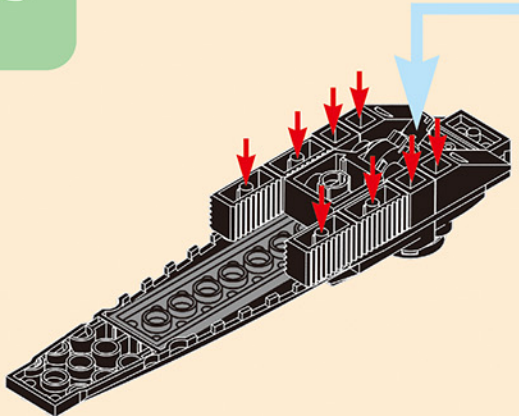

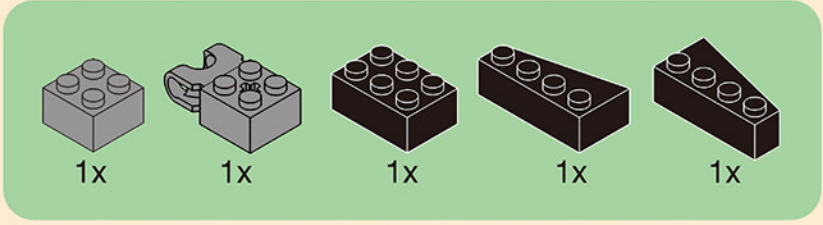

6-18

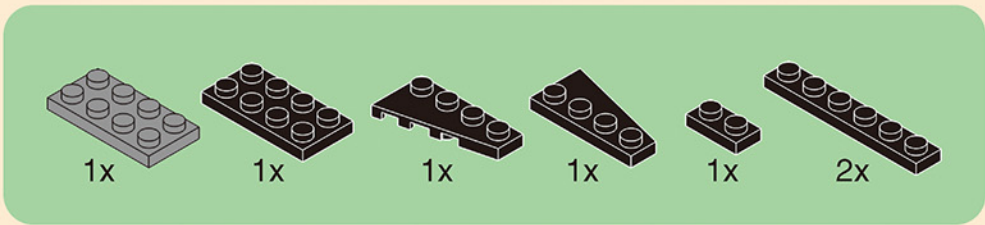
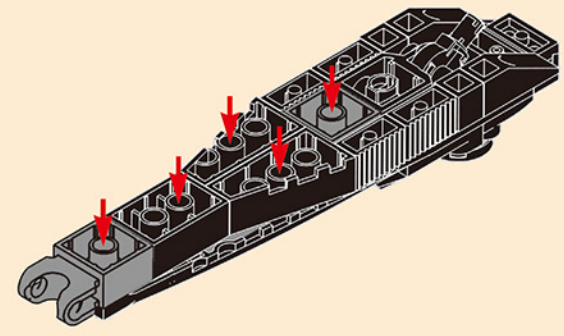

6-19

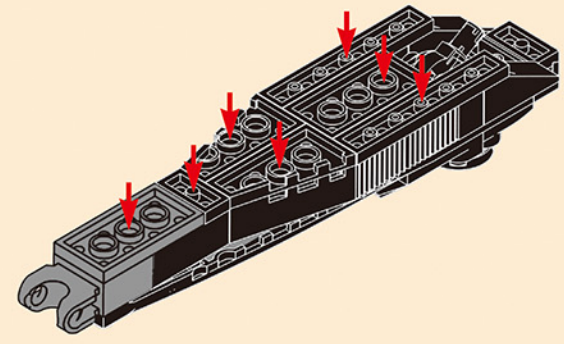

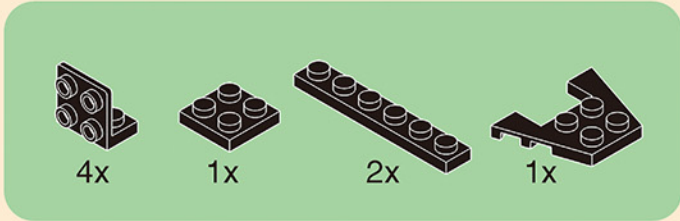

6-20

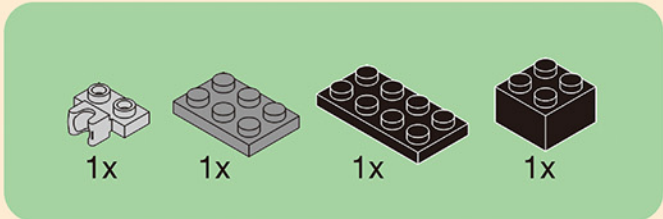
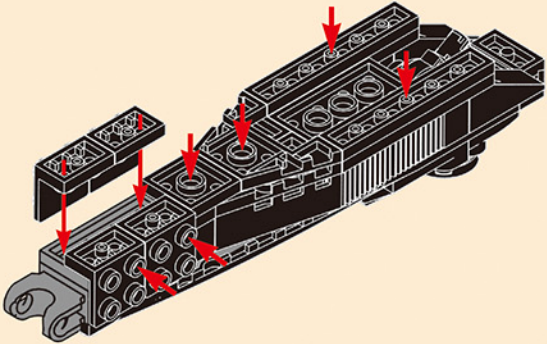

6-21

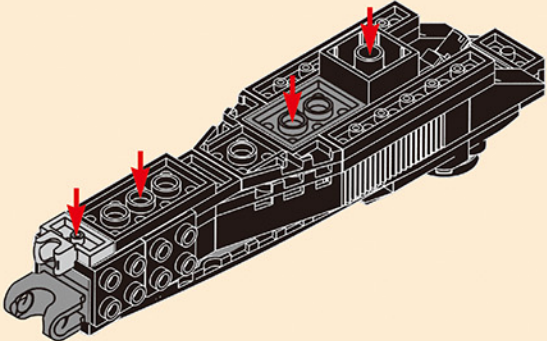

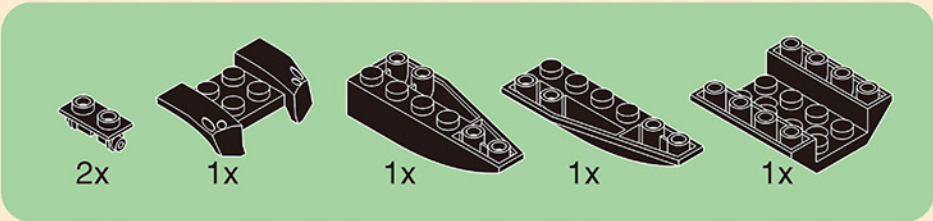

6-22

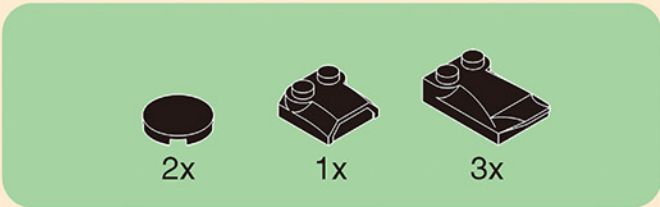
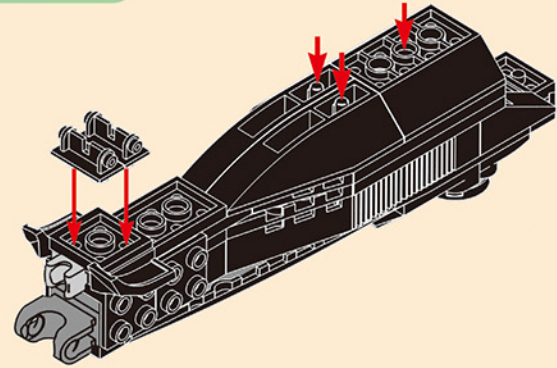

6-23

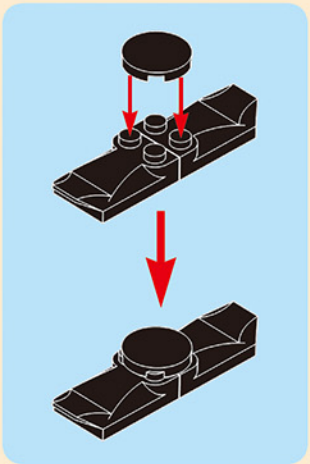
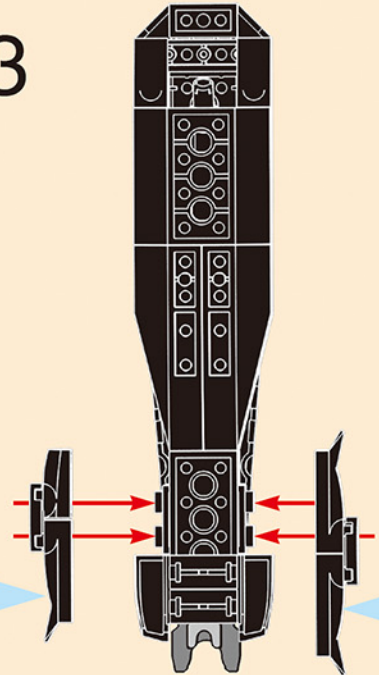
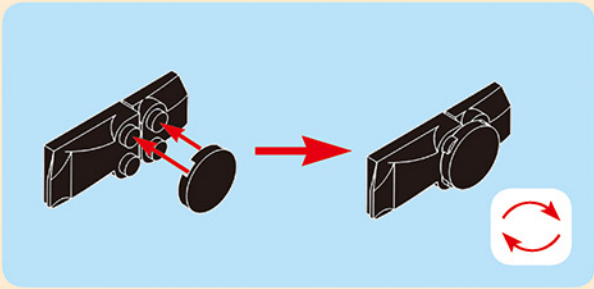

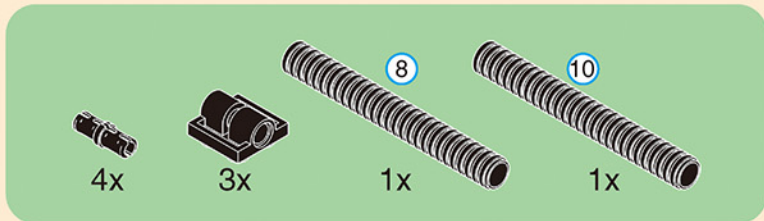
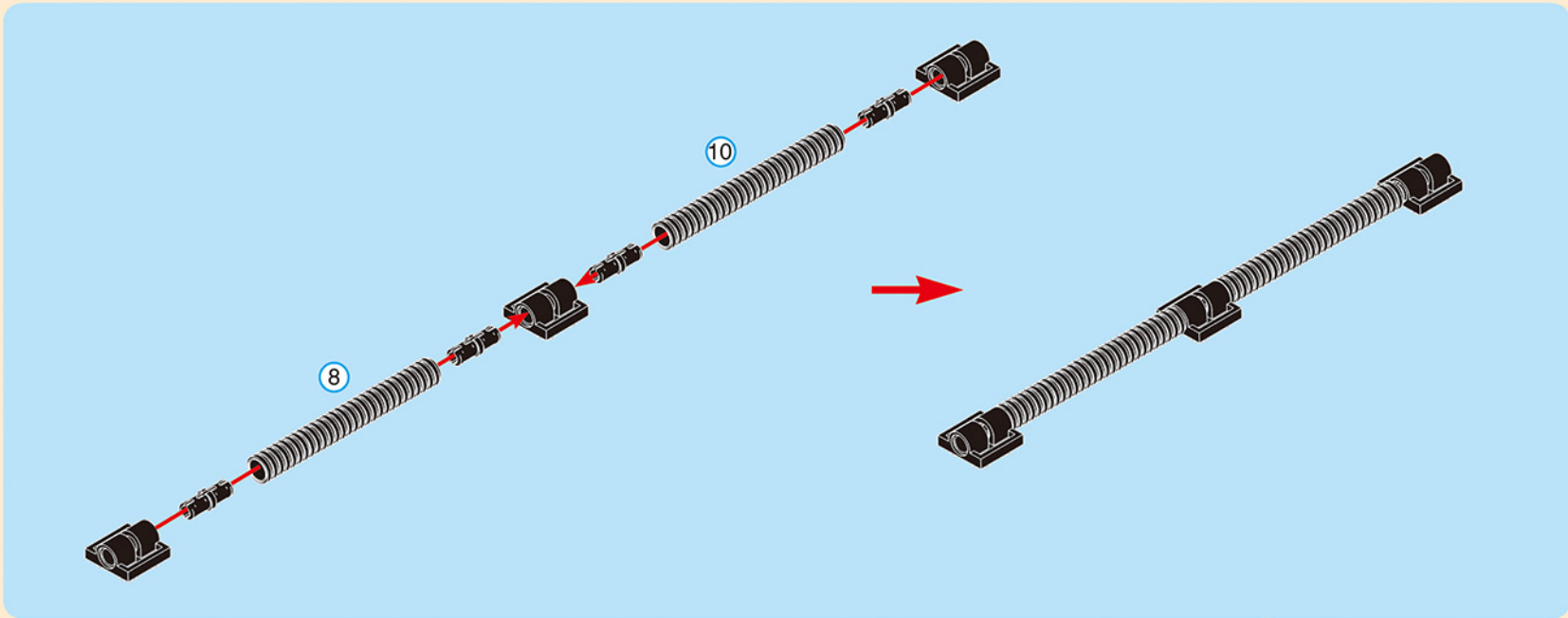

6-24

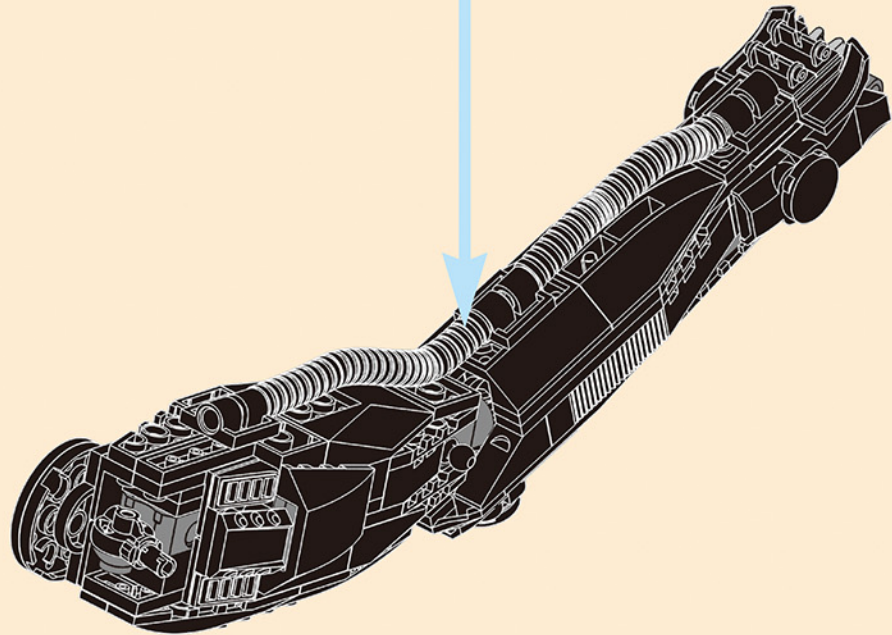

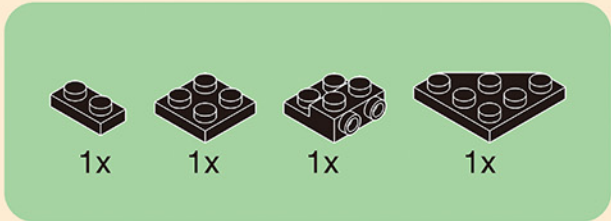

6-25.1

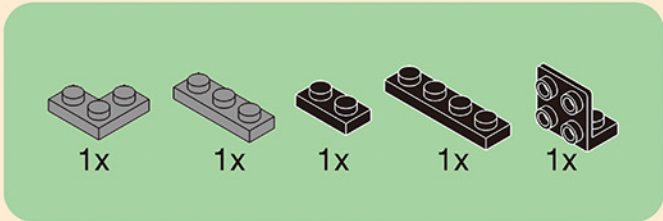
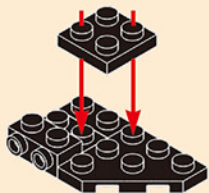

6-25.2

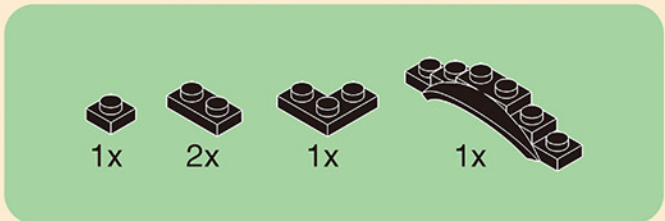
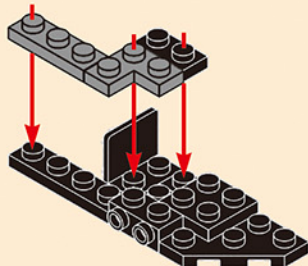

6-25.3

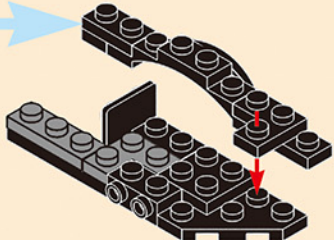
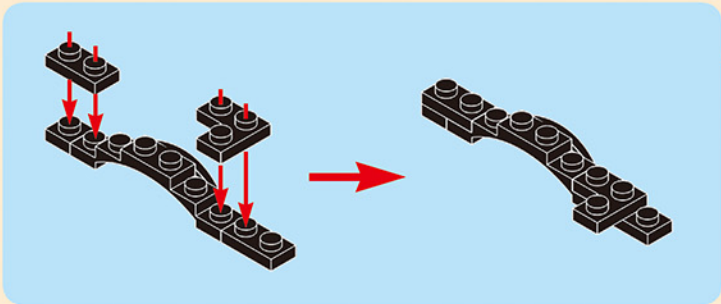

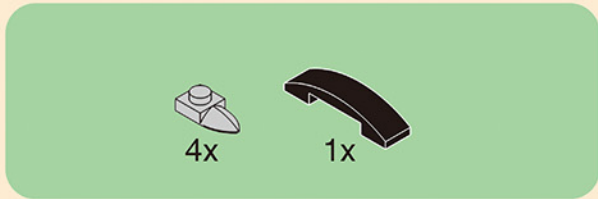

6-25.4

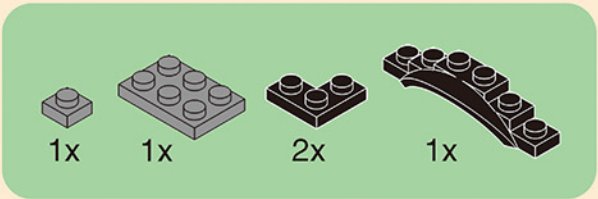
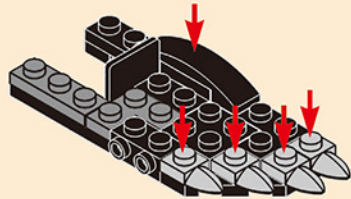

6-25.5

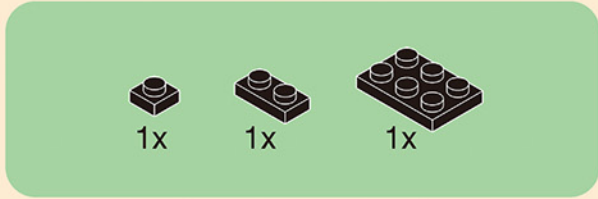
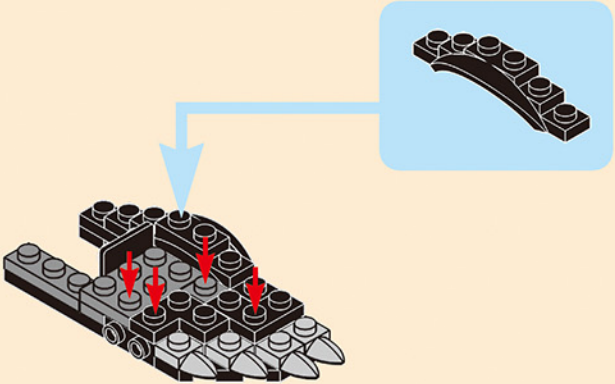

6-25.6

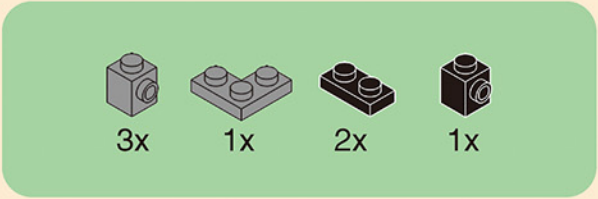
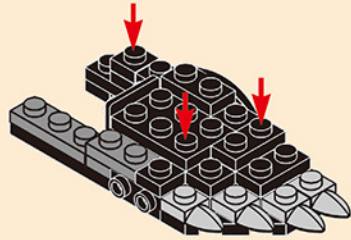

6-25.7

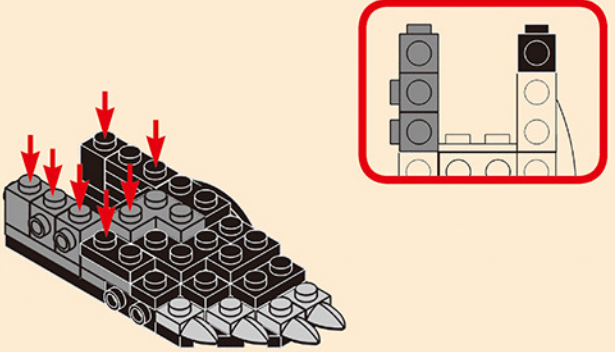

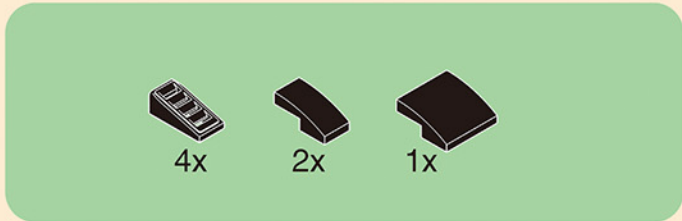

6-25.8

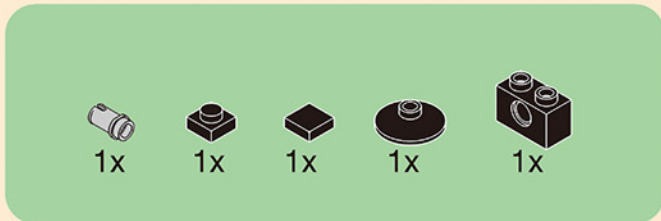
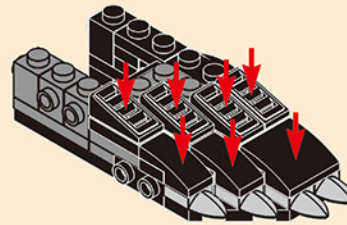

6-25.9

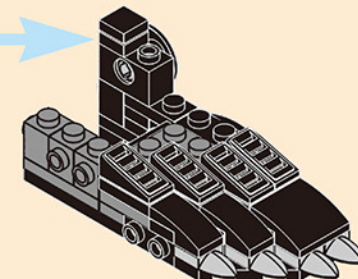
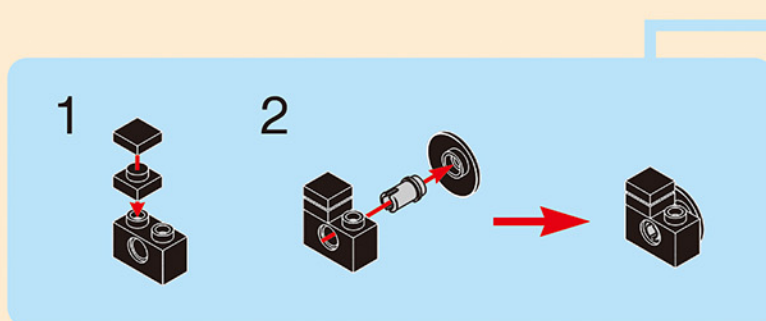

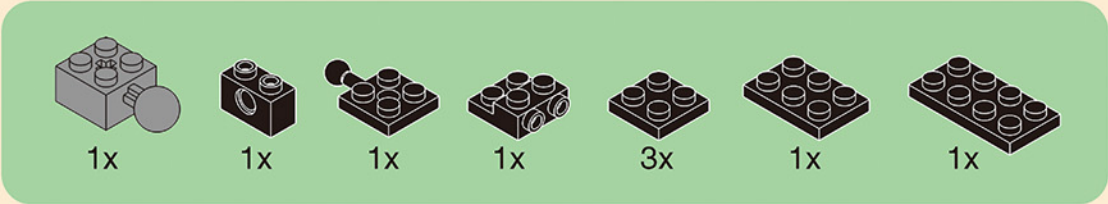

6-25.10.1

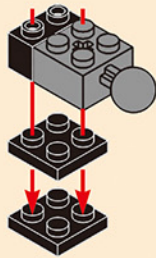

6-25.10.2

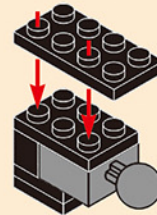

6-25.10.3

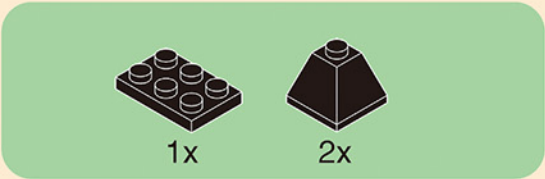
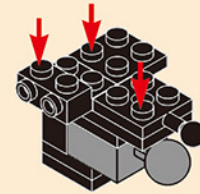

6-25.10.4

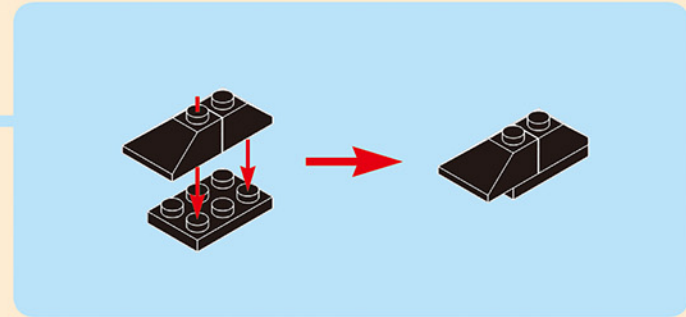
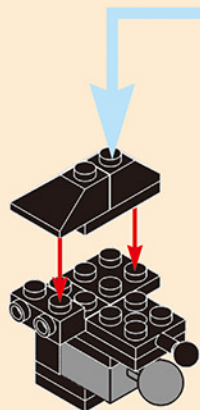

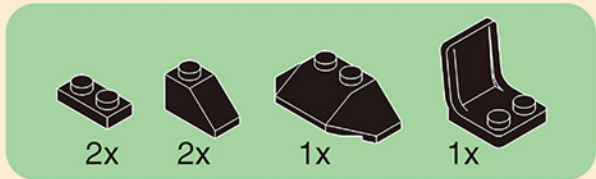

6-25.10.5

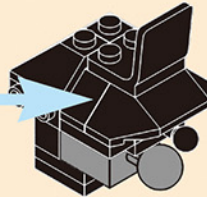
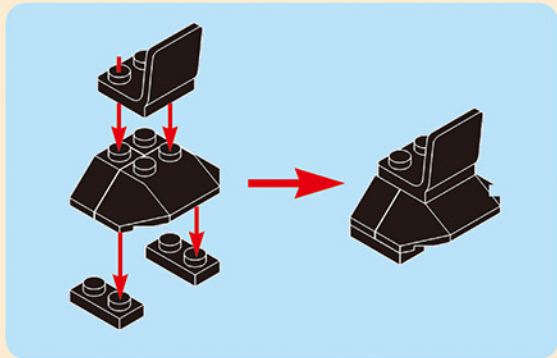

6-25.10

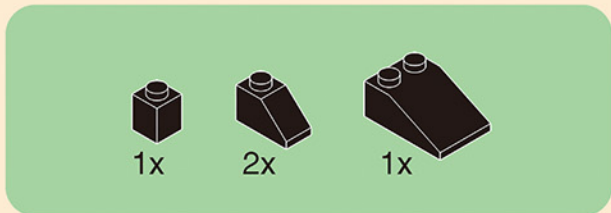
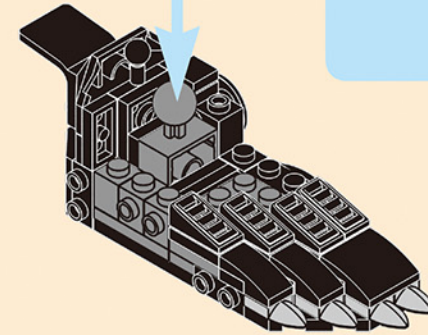
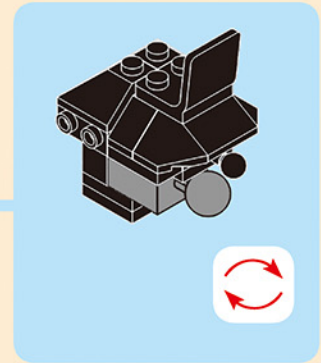

6-25.11

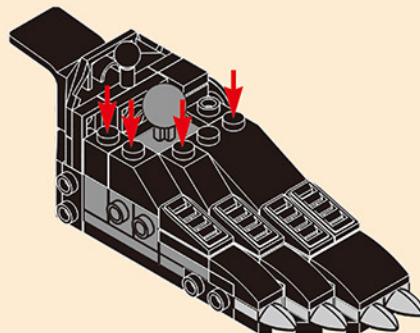

6-25.12

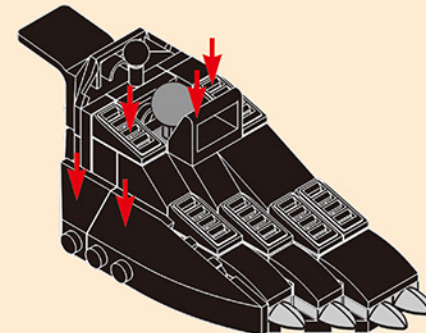

6-25.13

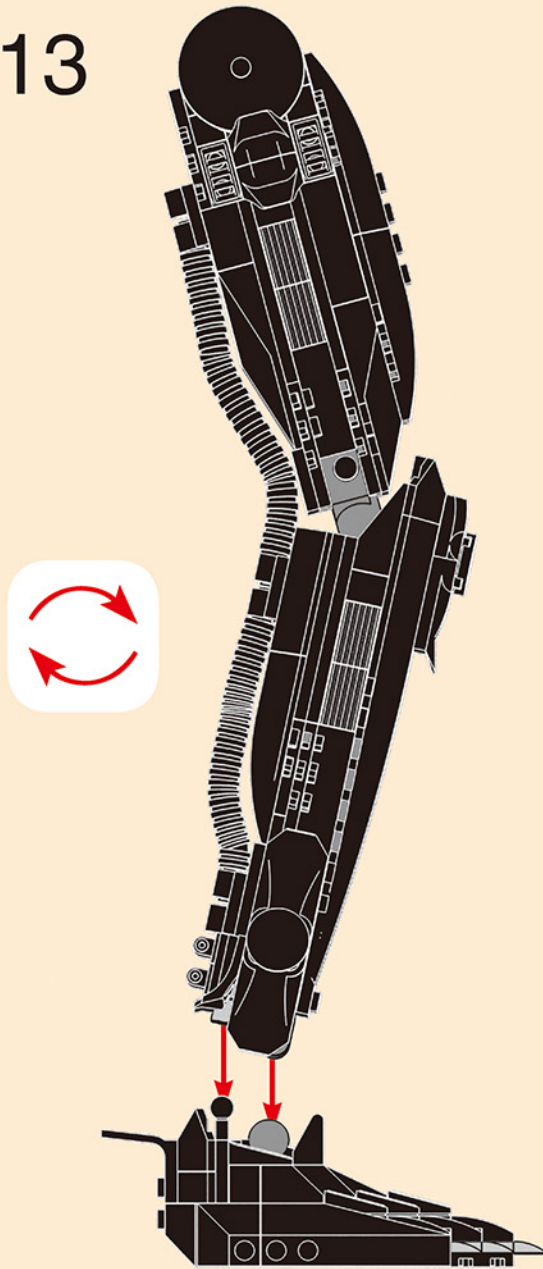

6-25

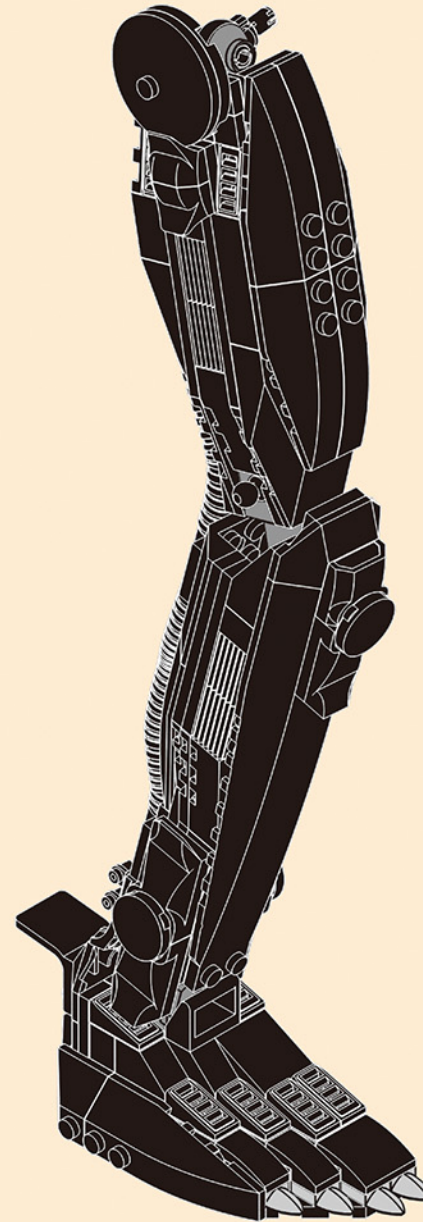

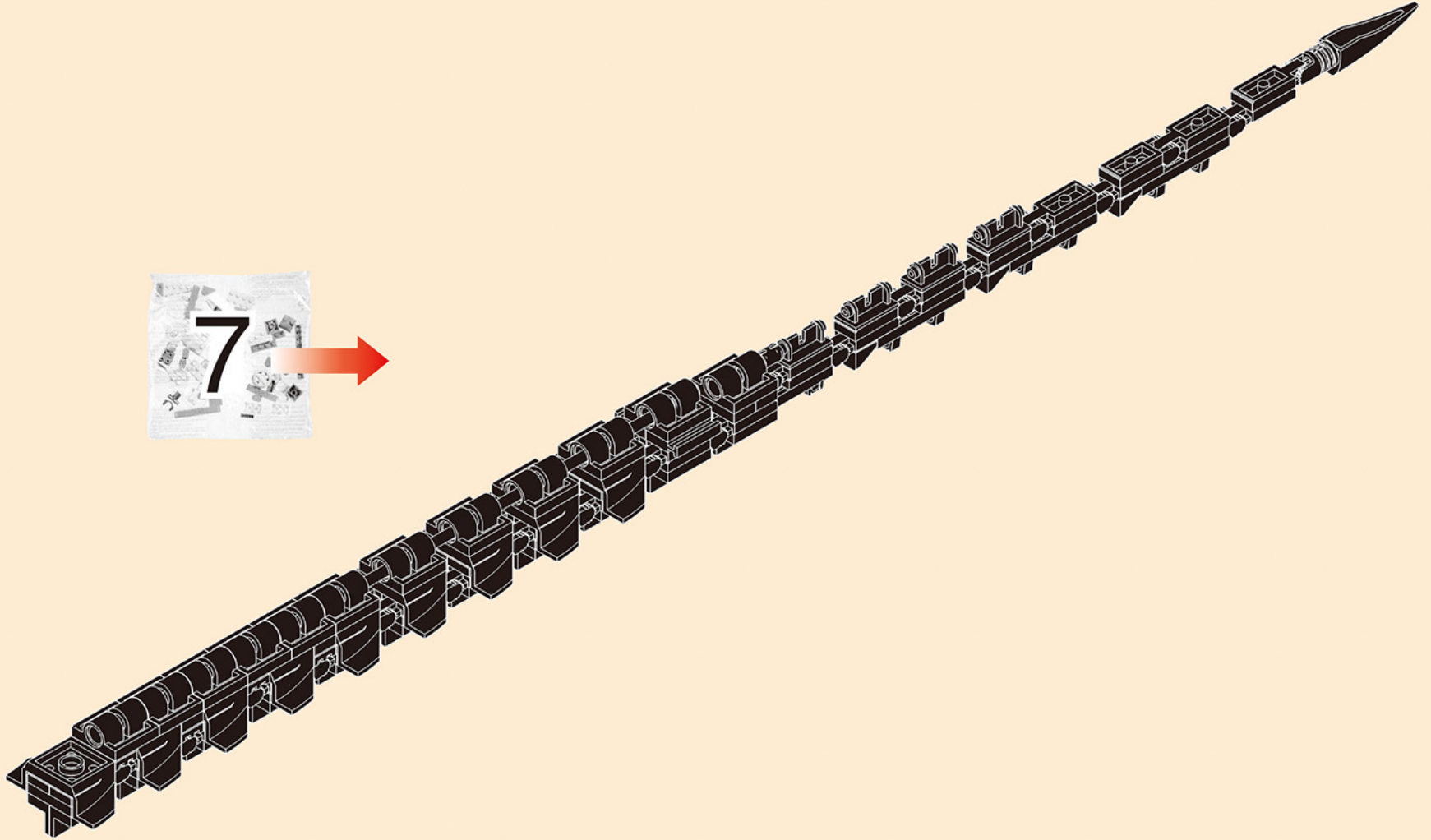

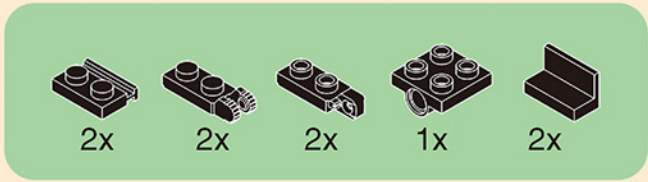

7-1

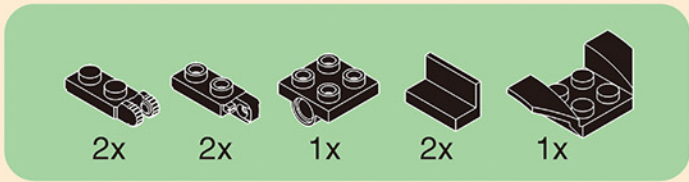
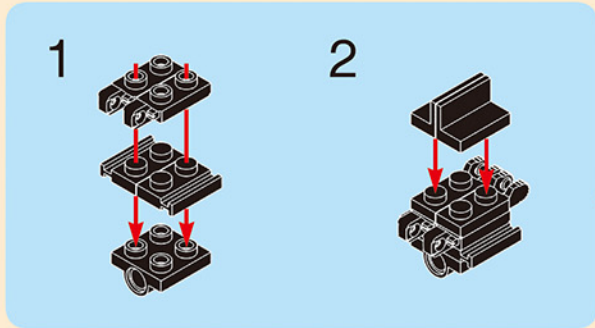

7-2

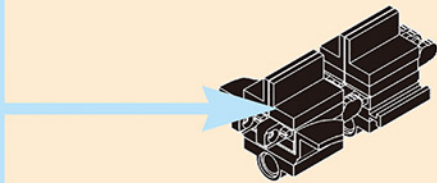
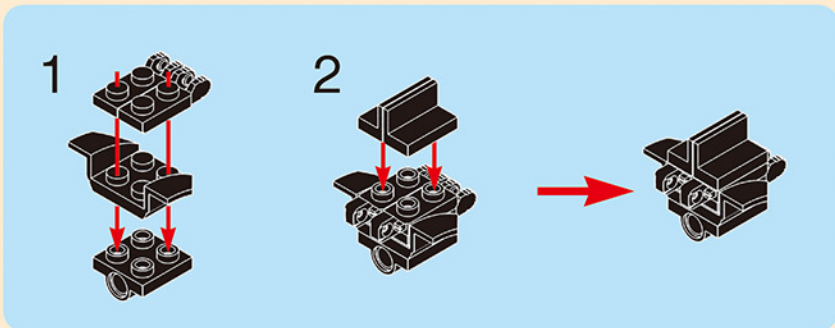

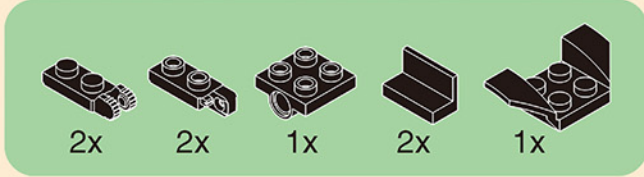

7-3

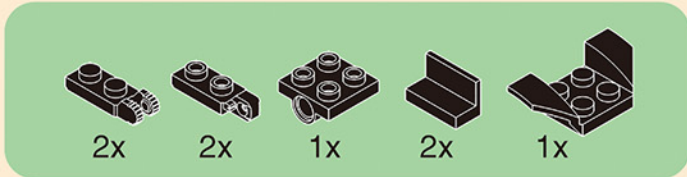
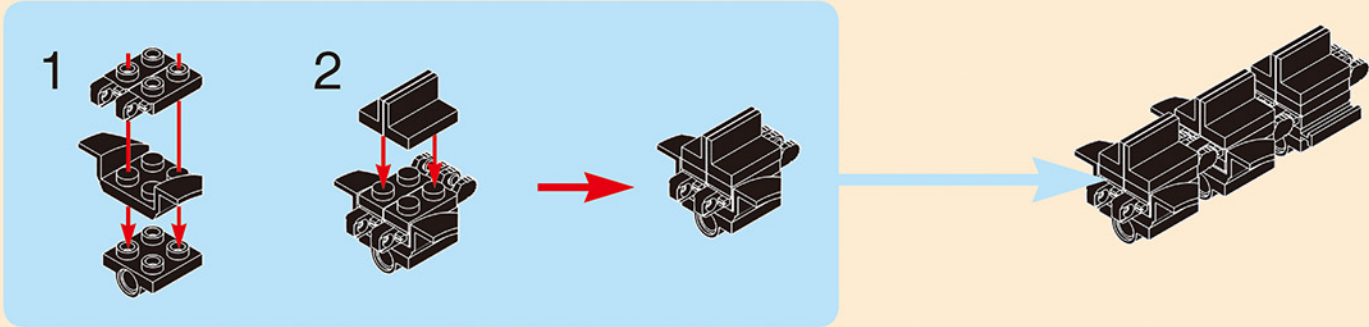

7-4

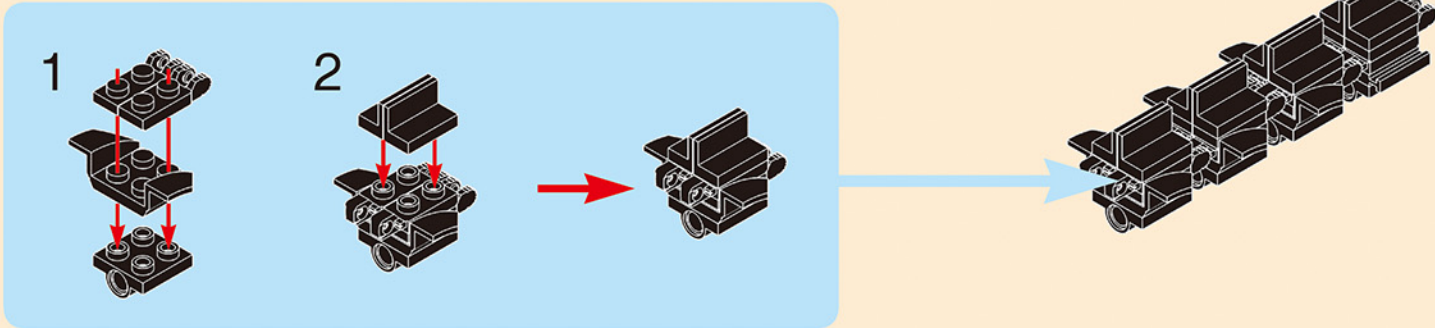

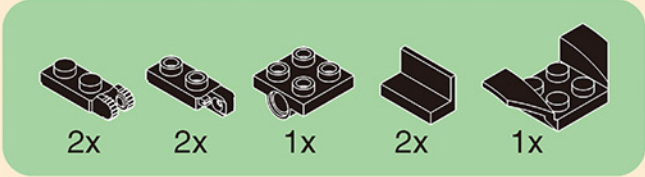

7-5

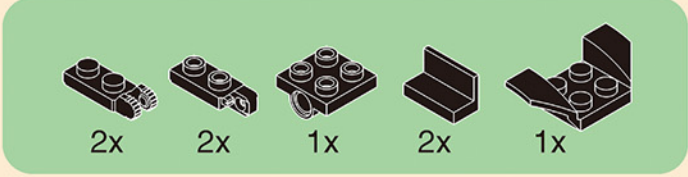
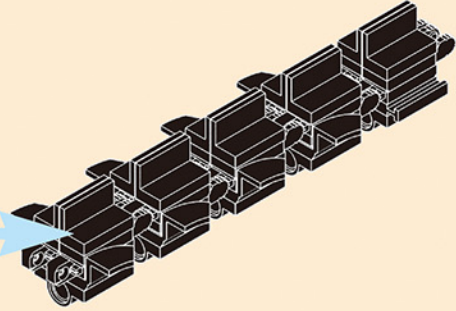
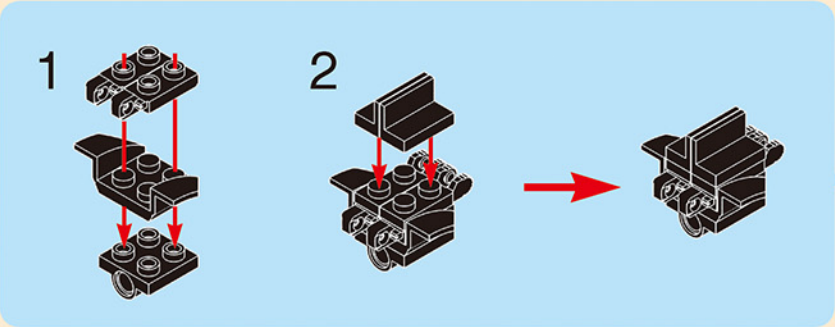

7-6

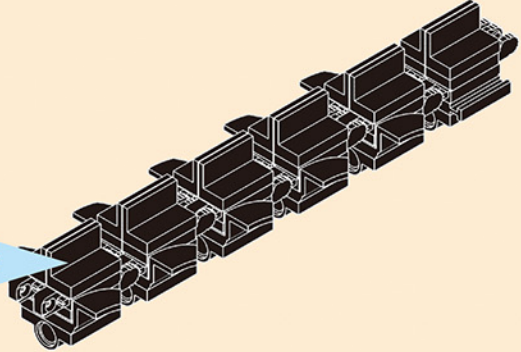
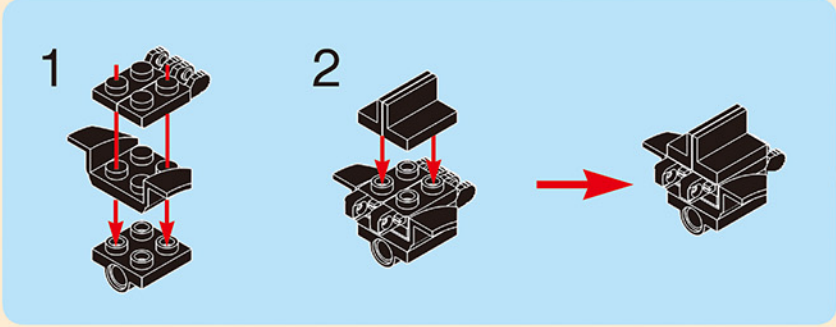

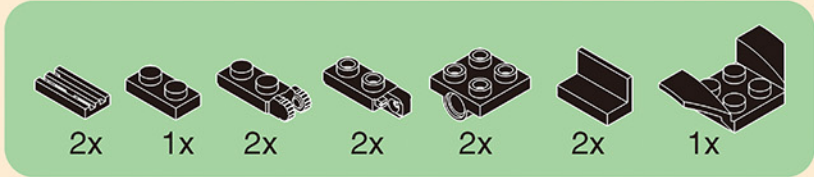

7-7

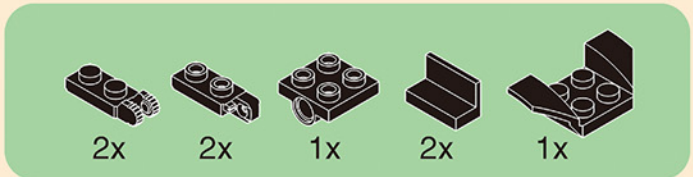
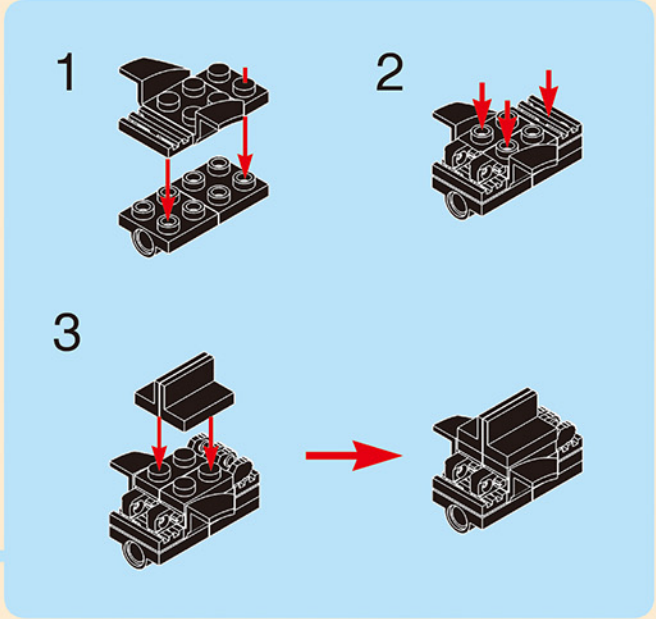
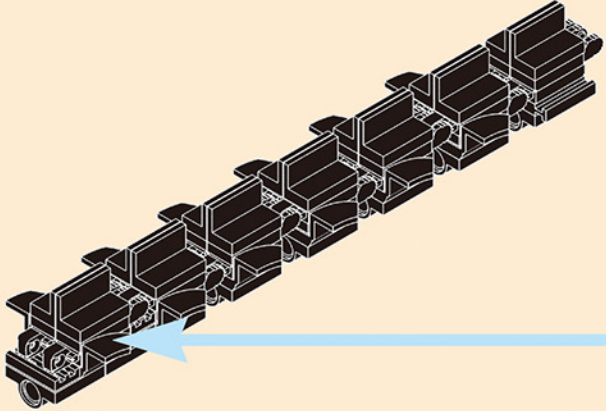

7-8

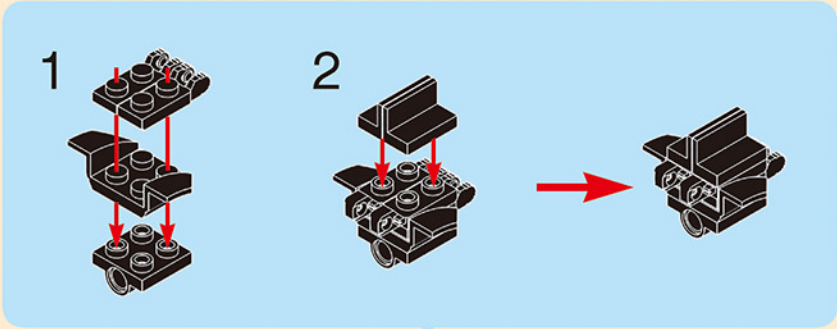
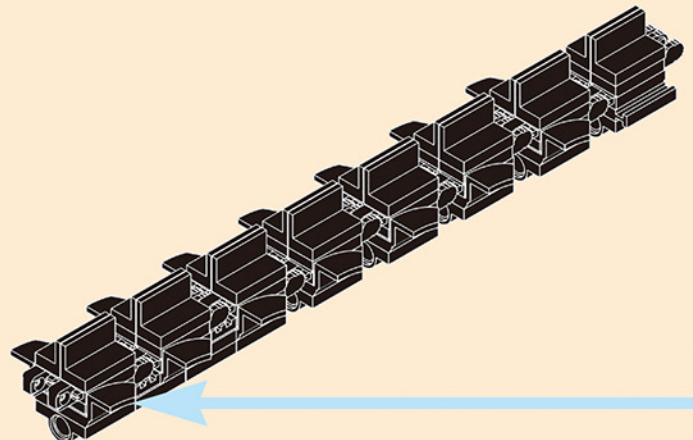

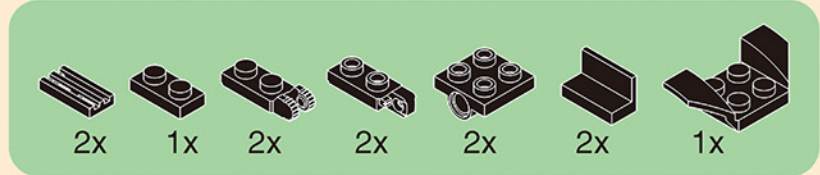

7-9

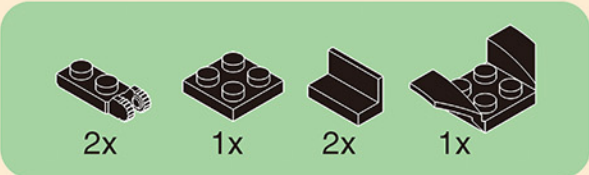
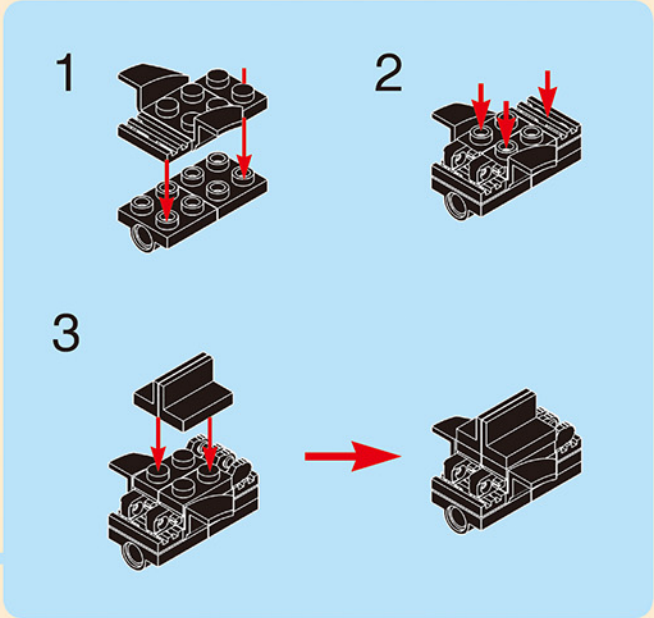
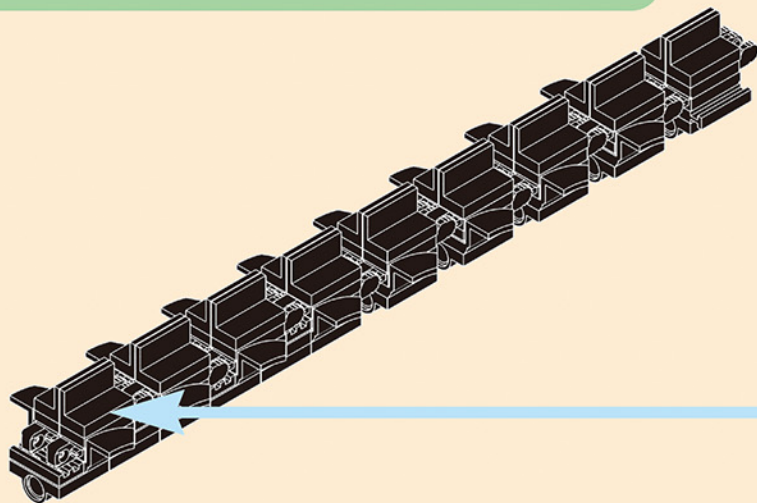

7-10

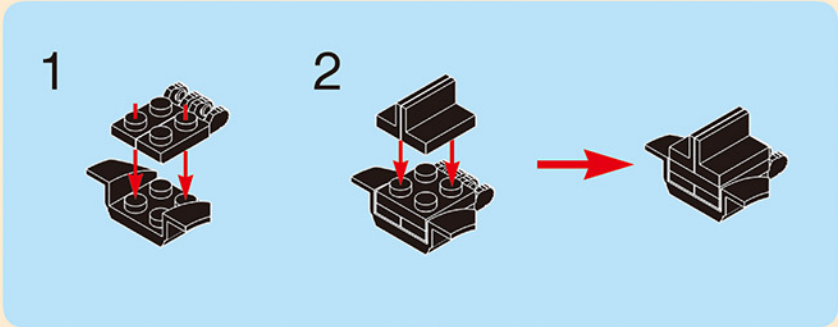
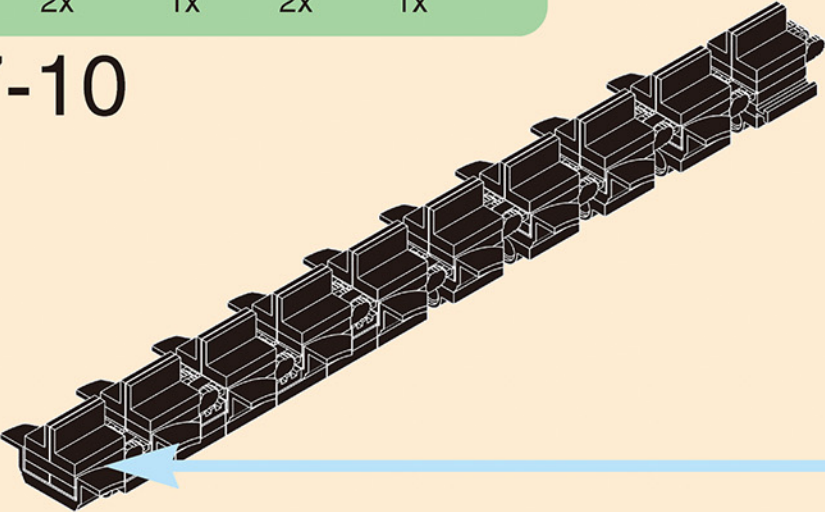

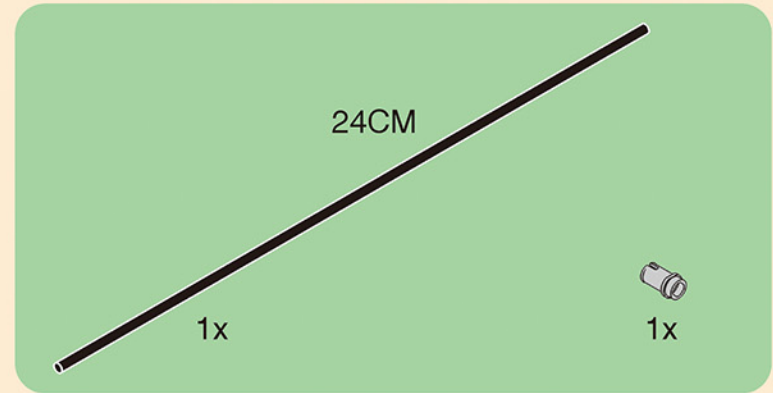
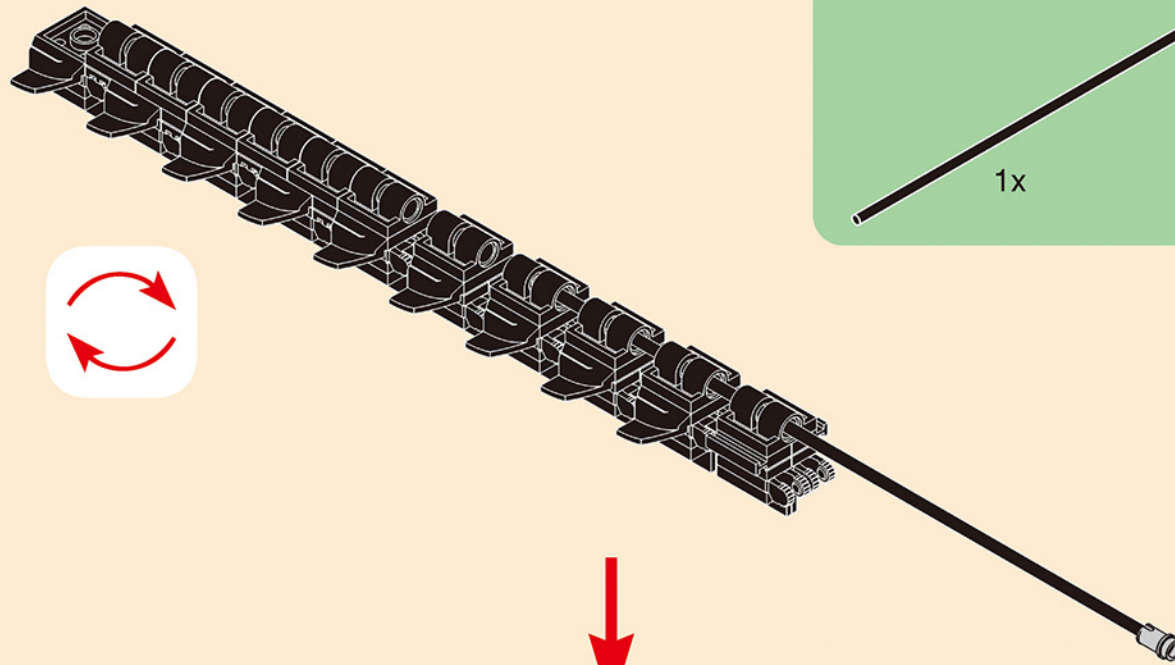

7-11

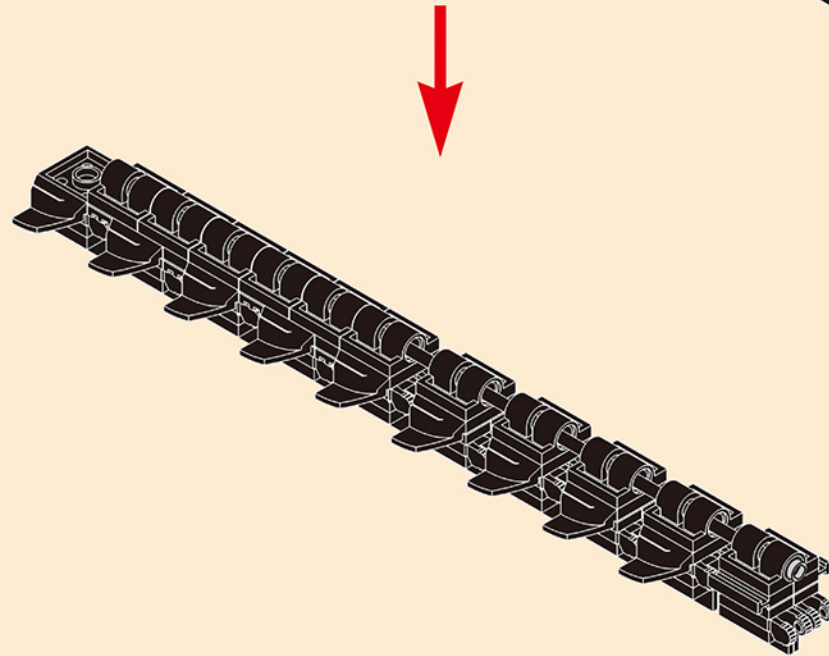

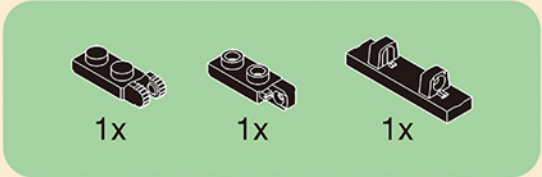

7-12.1

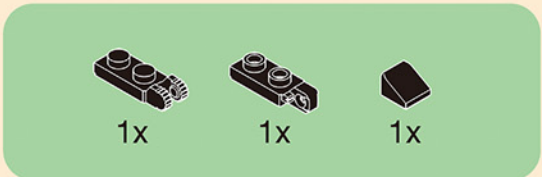
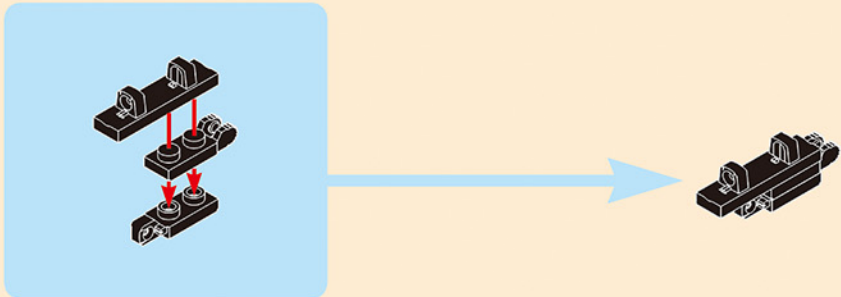

7-12.2

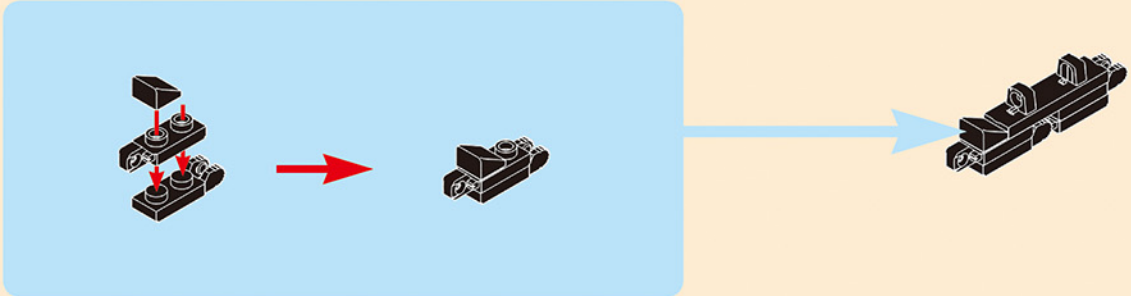

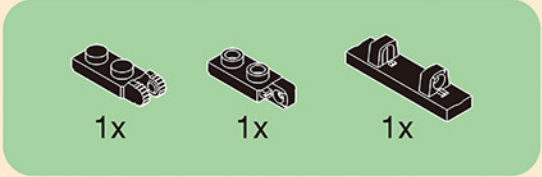

7-12.3

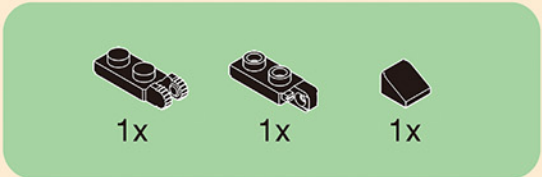
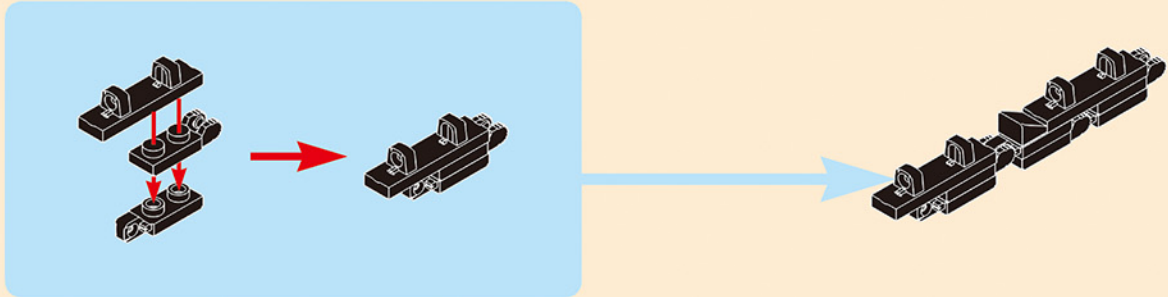

7-12.4

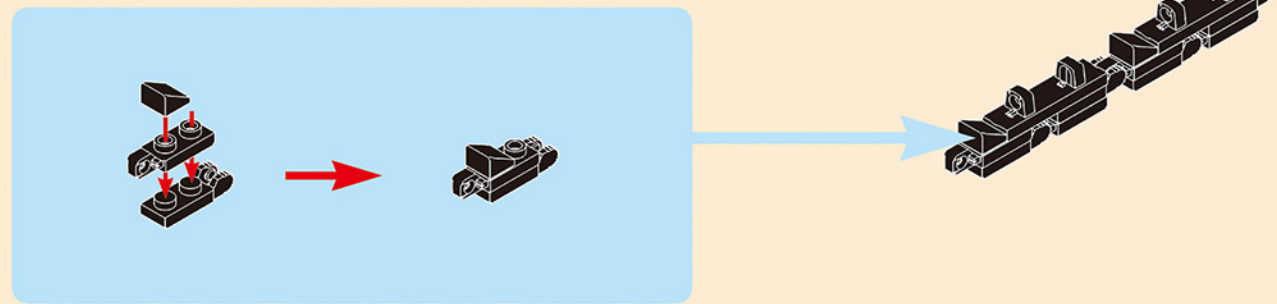

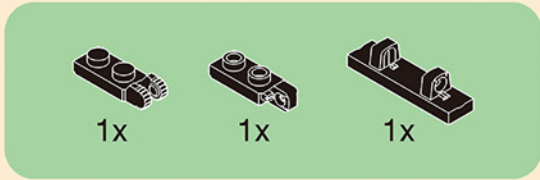

7-12.5

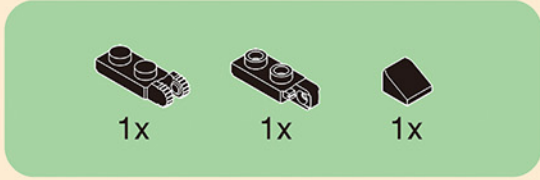
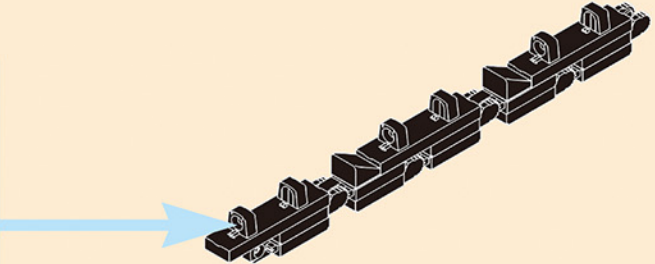
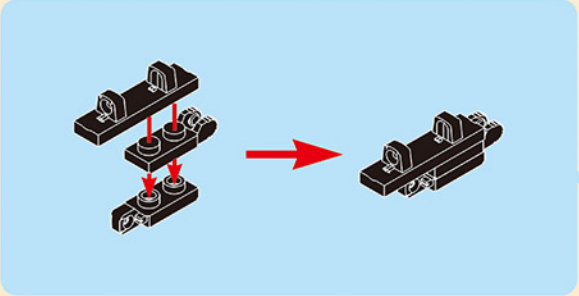

7-12.6

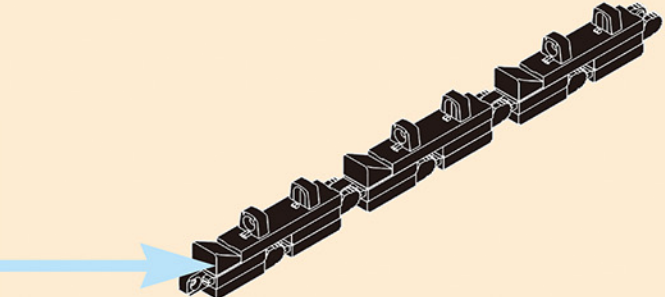
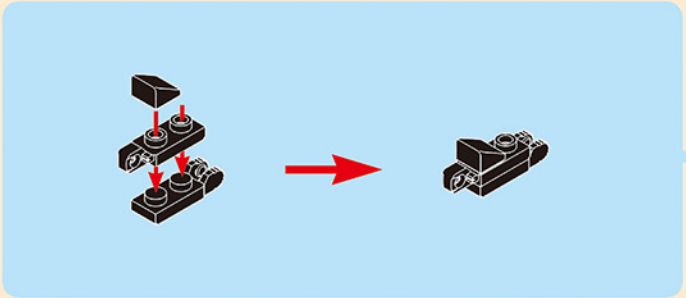

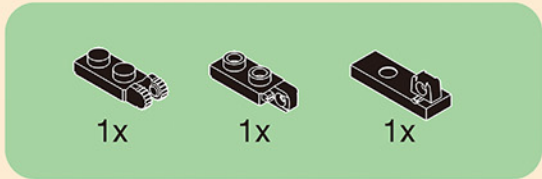

7-12.7

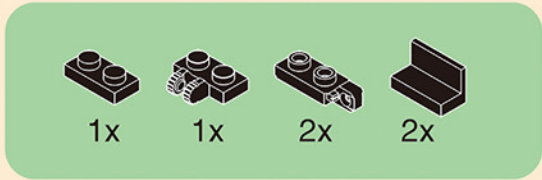
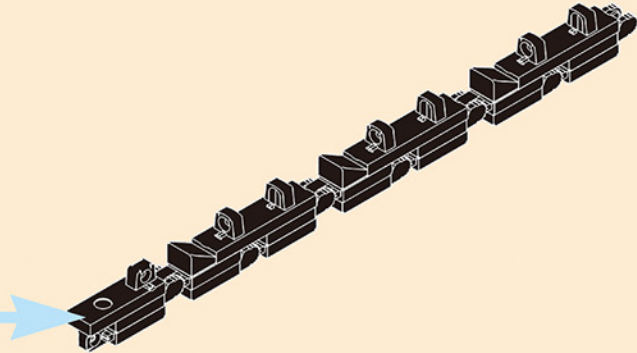
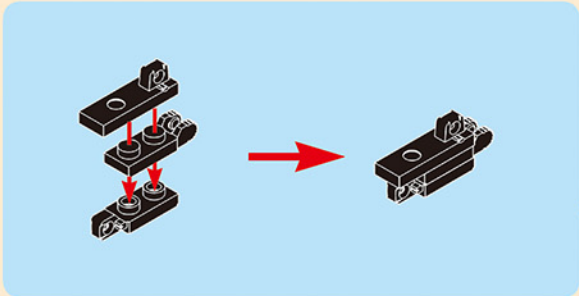

7-12.8

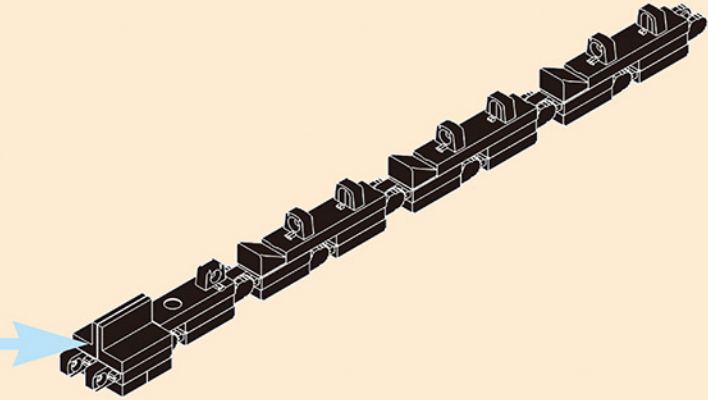
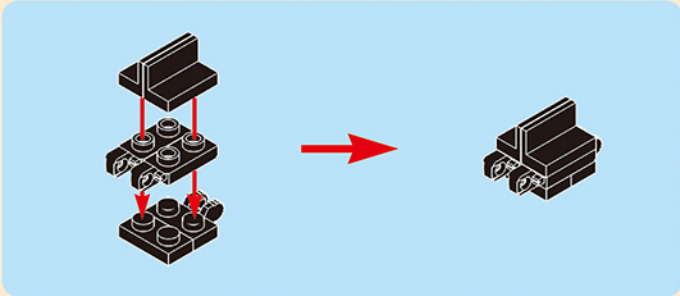

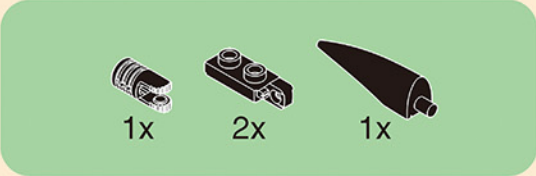

7-12.9

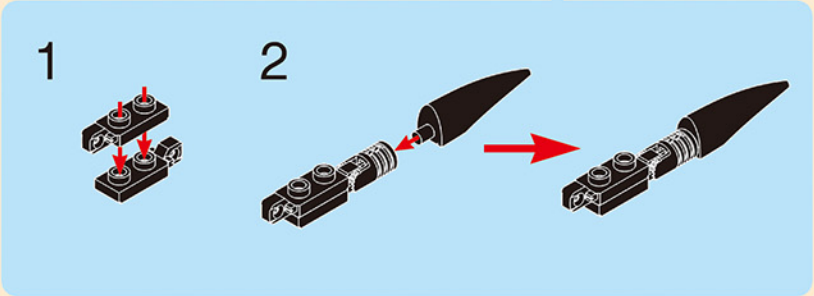
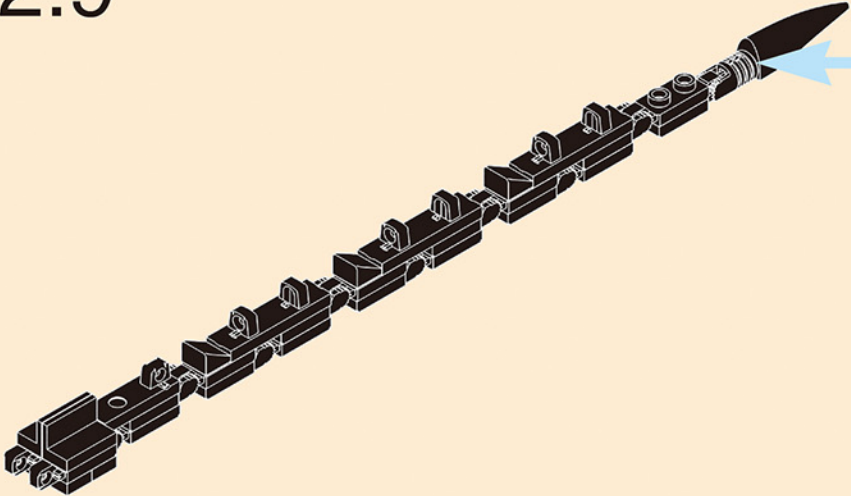

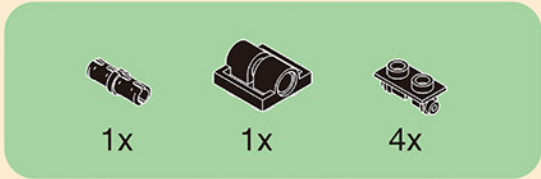

7-12

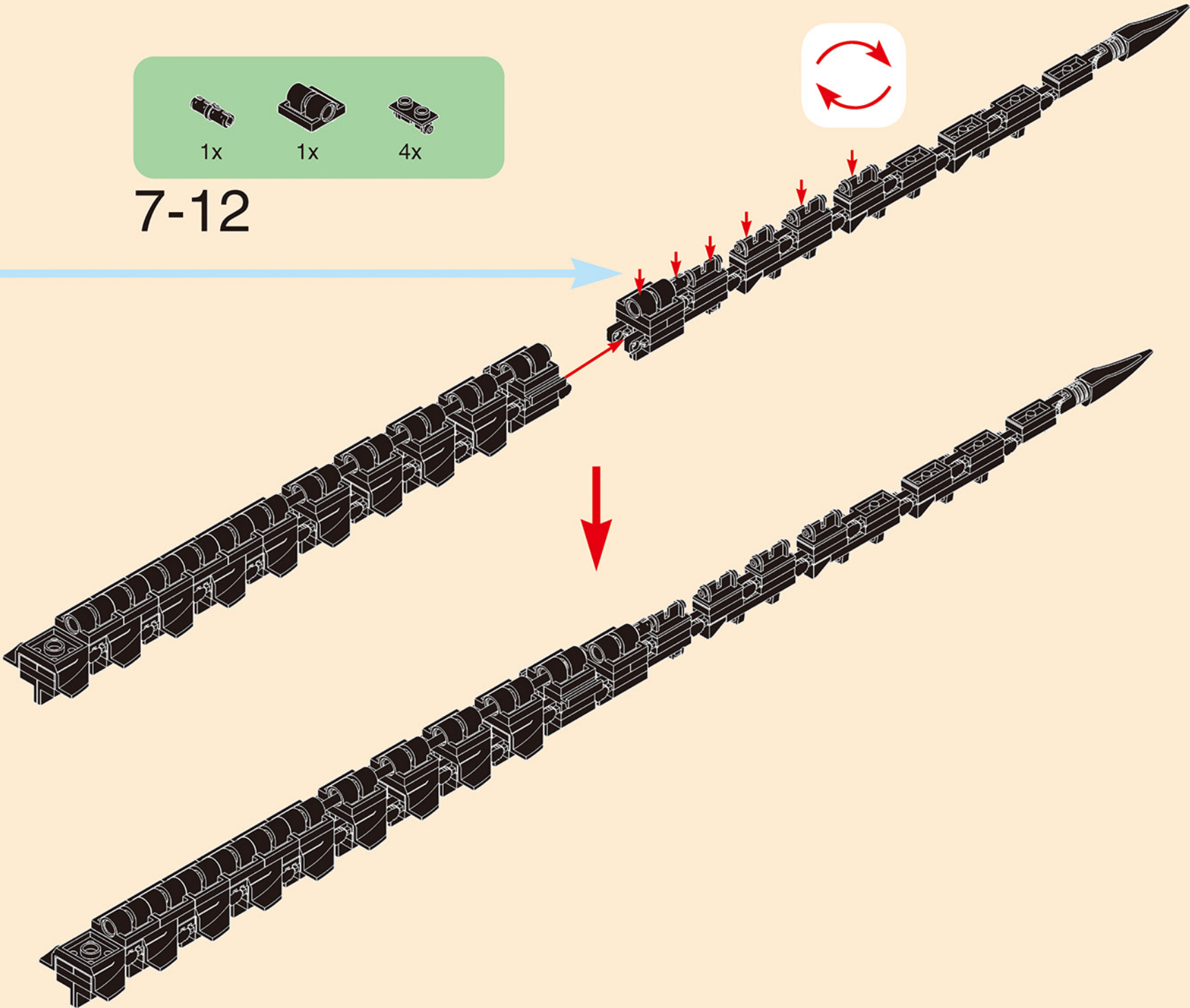

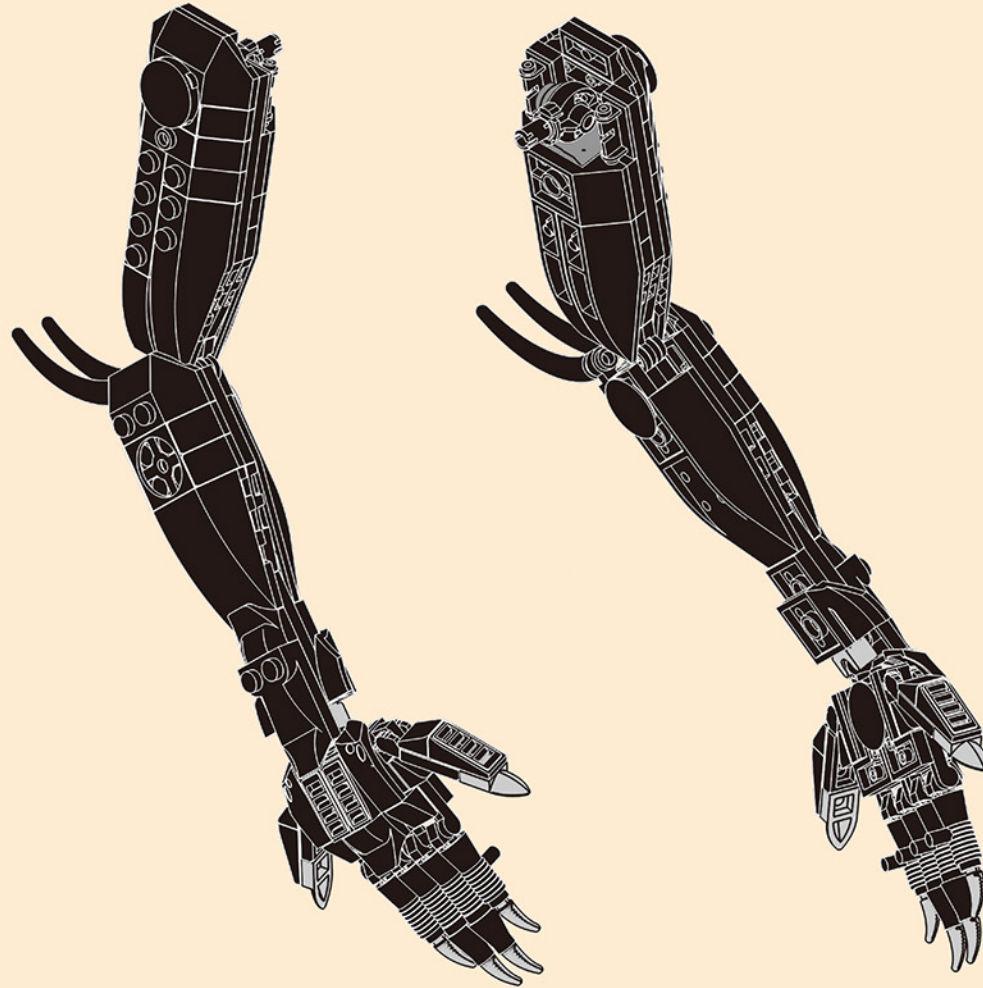

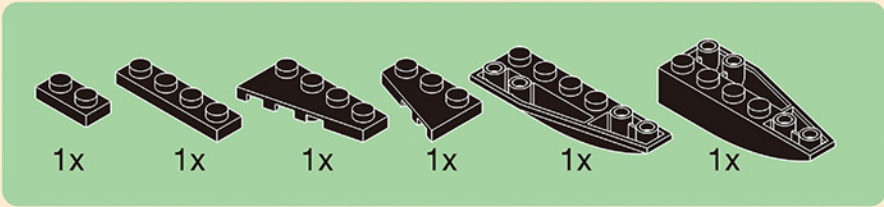

8-1

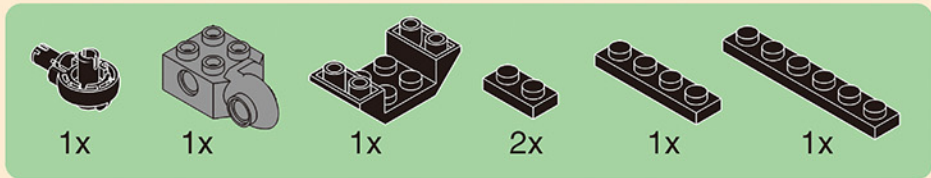
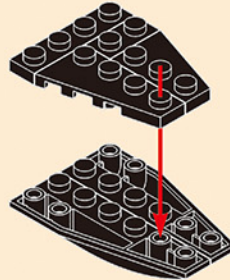

8-2

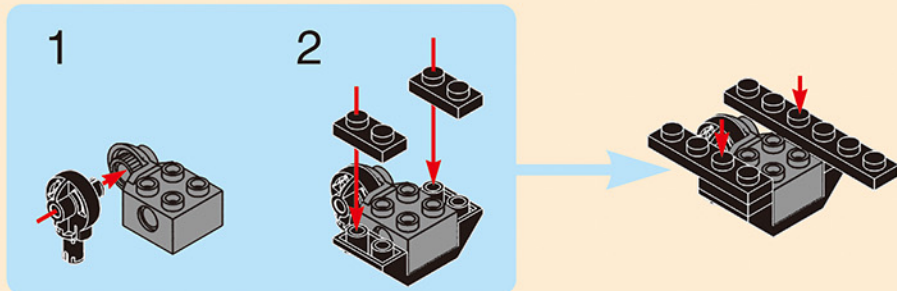

8-3

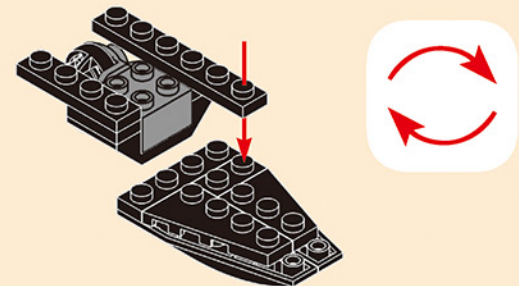

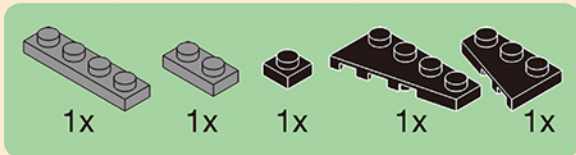

8-4

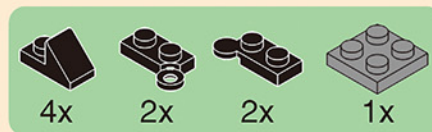
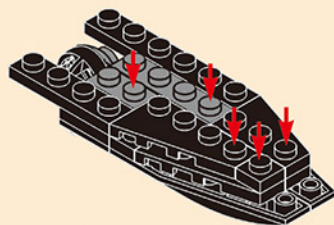

8-5

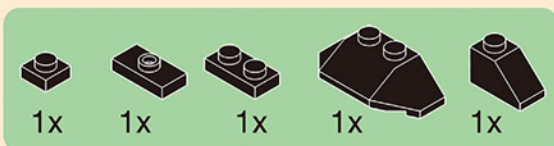
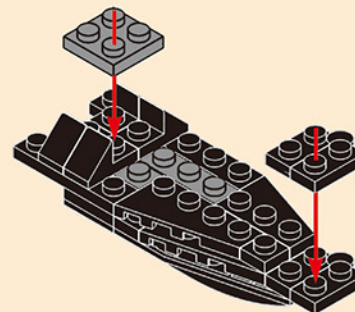
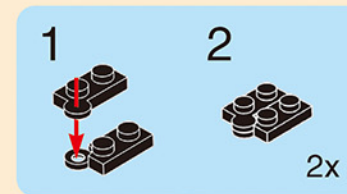

8-6

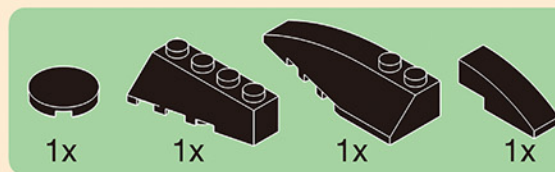
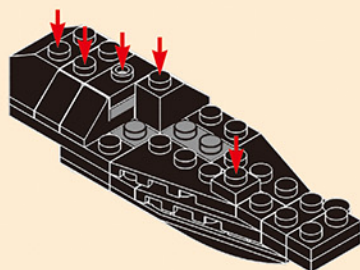

8-7

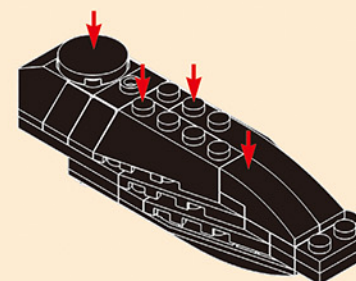

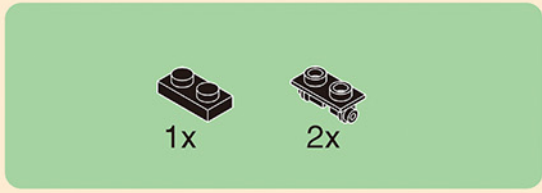

8-8

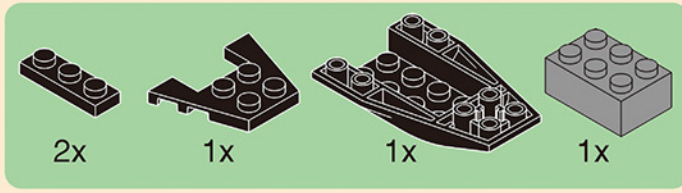
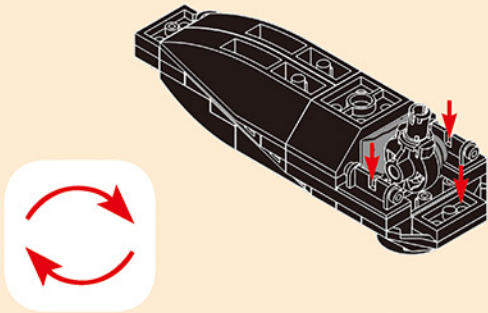

8-9

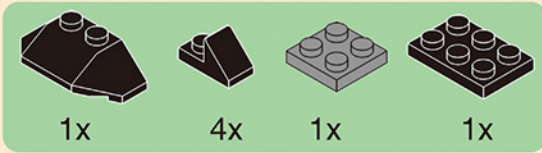
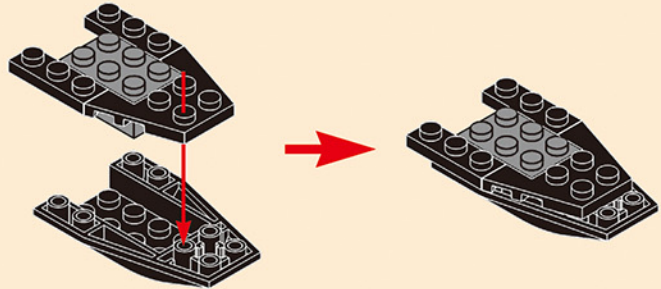

8-10

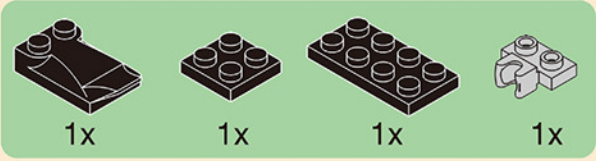
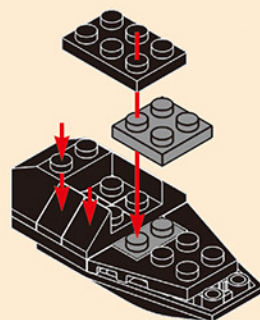

8-11

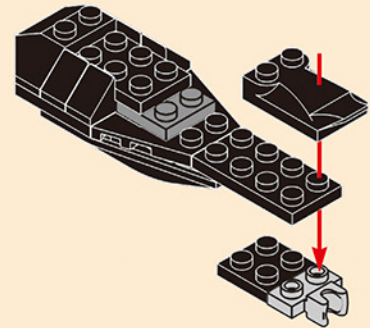



1x



1x



1x



1x

8-12

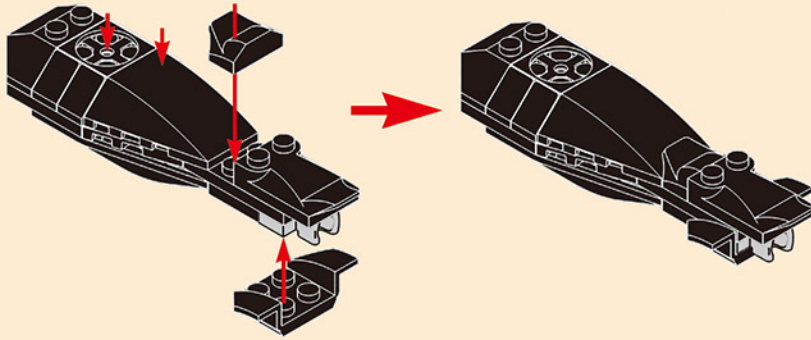

1x



2x



2x

8-13

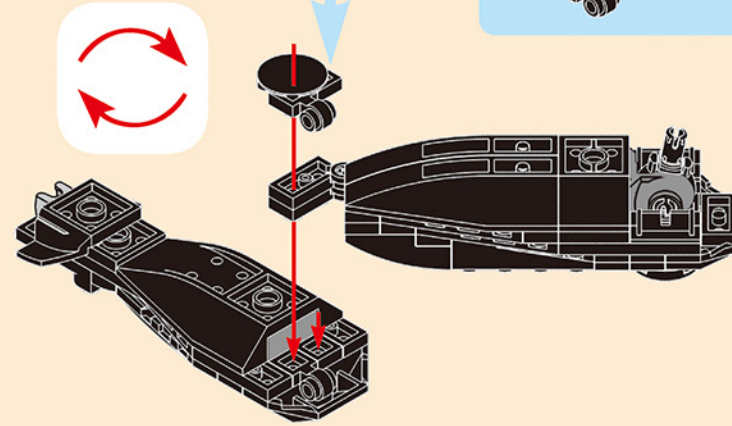

2x

8-14

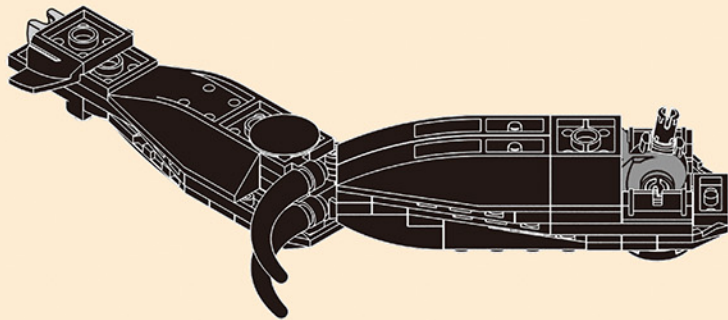

2x



1x



1x



2x



2x

8-15

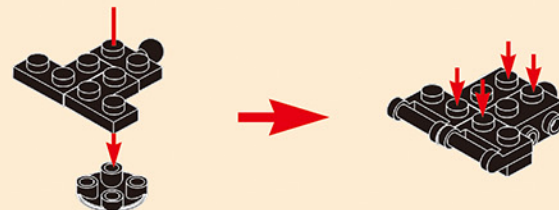

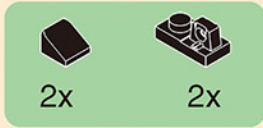

8-16

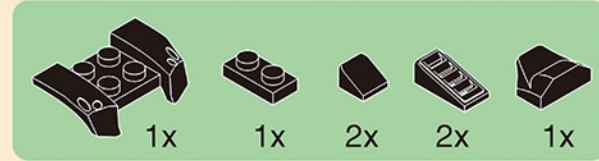
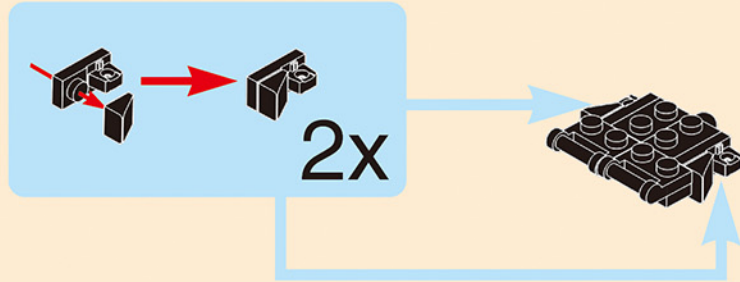

8-17

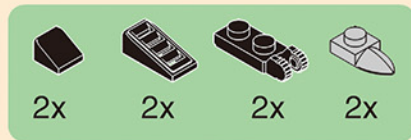

8-18

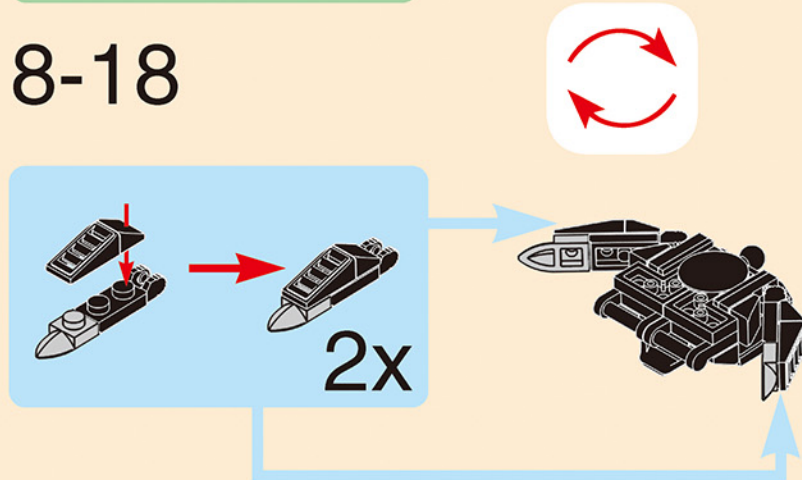

8-19

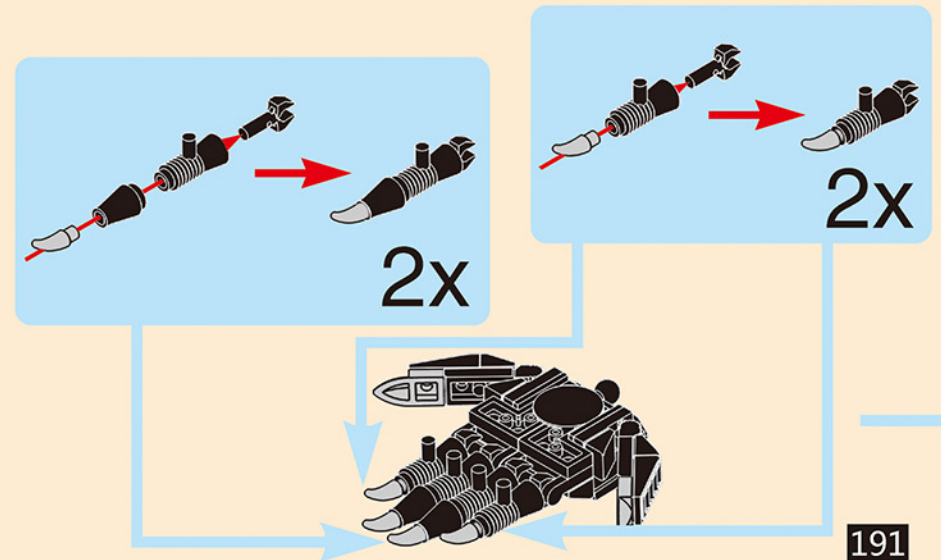

8-20

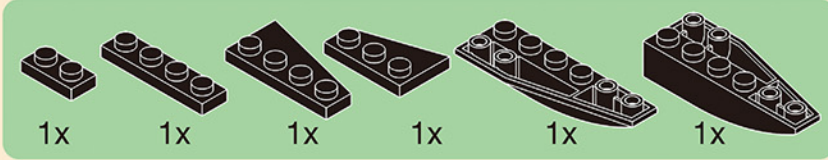
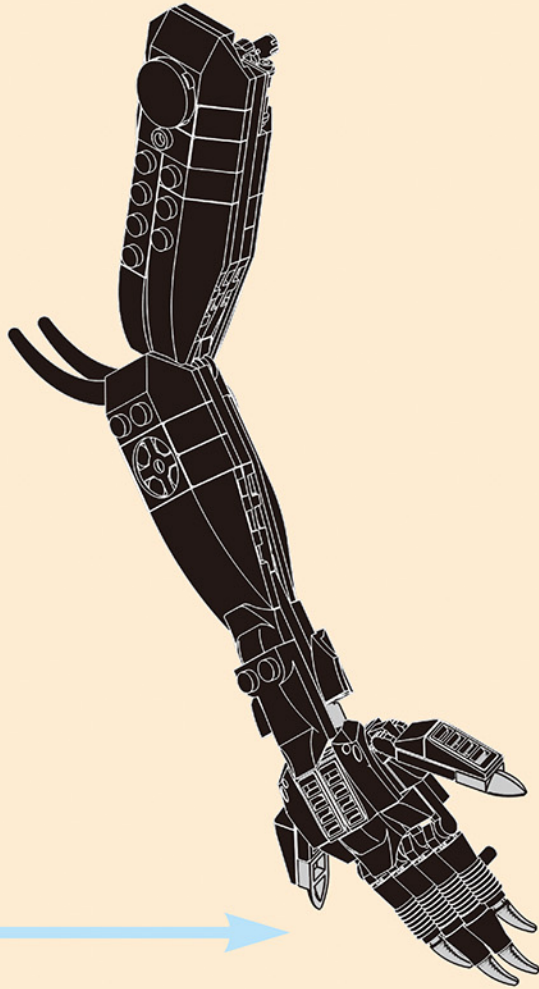

8-21

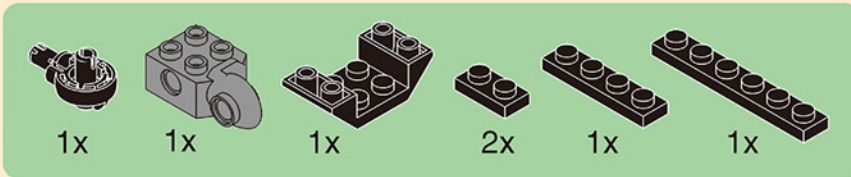
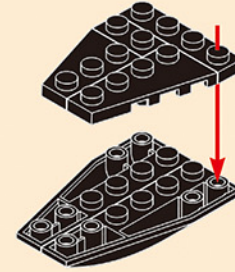

8-22

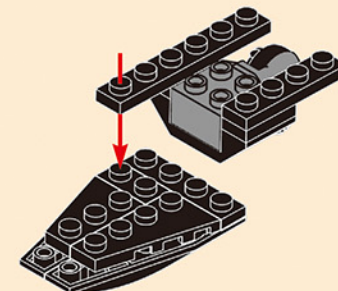
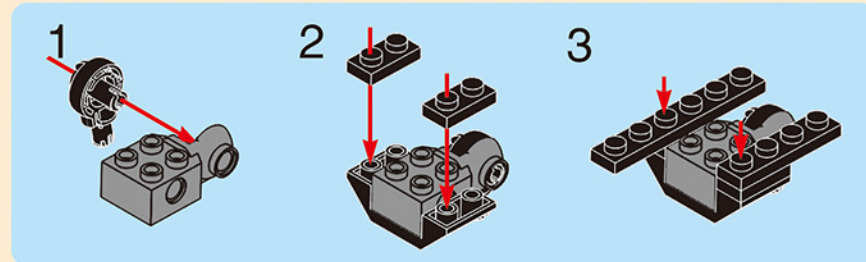

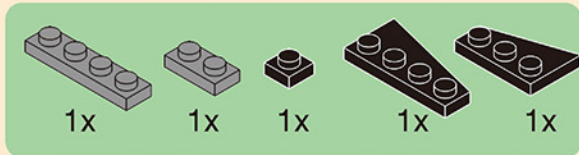

8-23

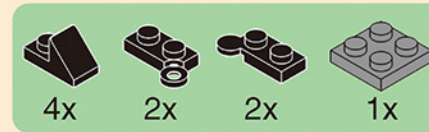
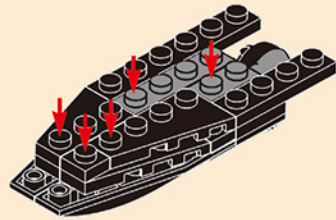

8-24

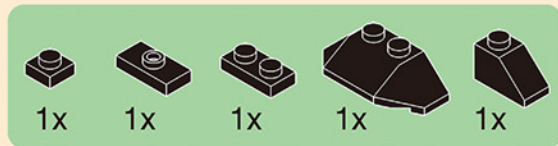
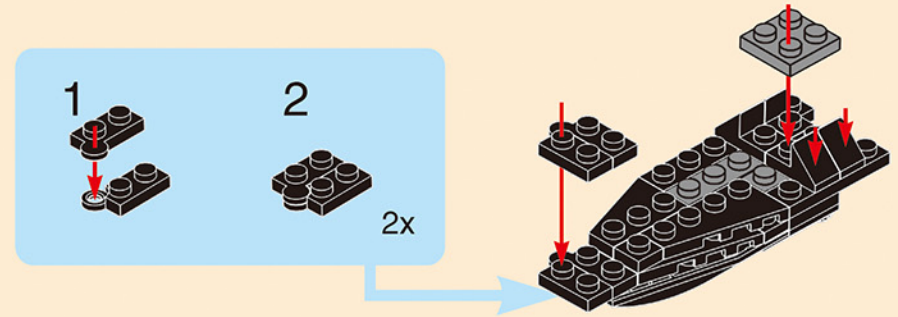

8-25

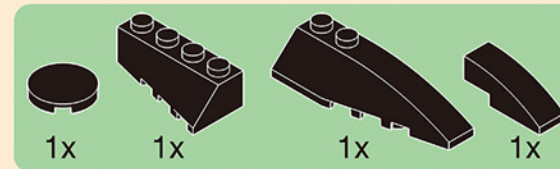
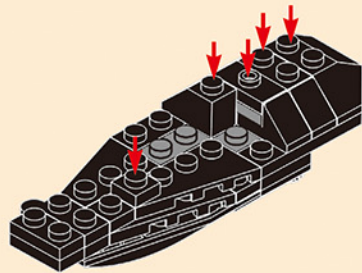

8-26

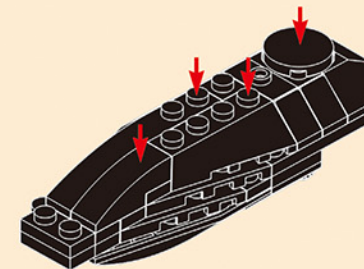



8-27

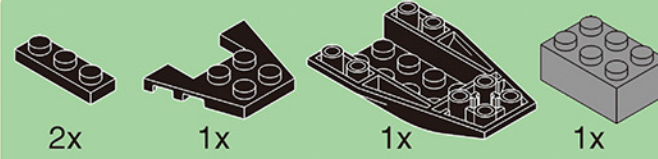
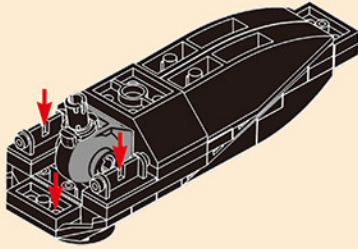

8-28

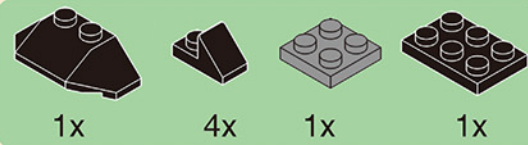
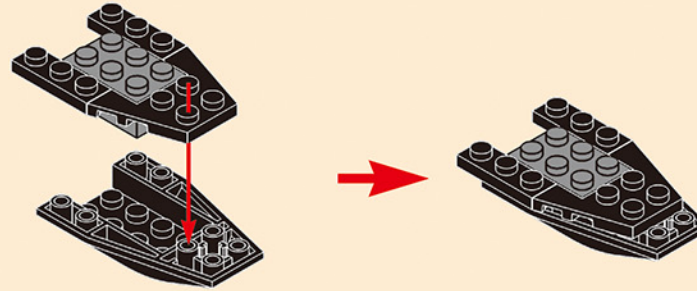

8-29

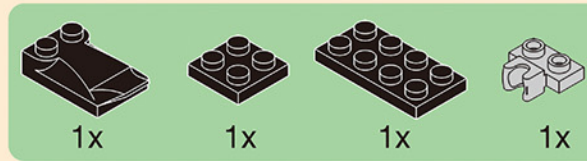
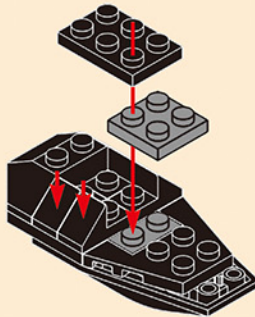

8-30

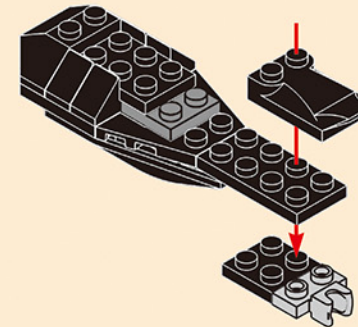

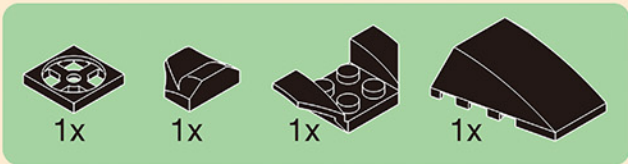

8-31

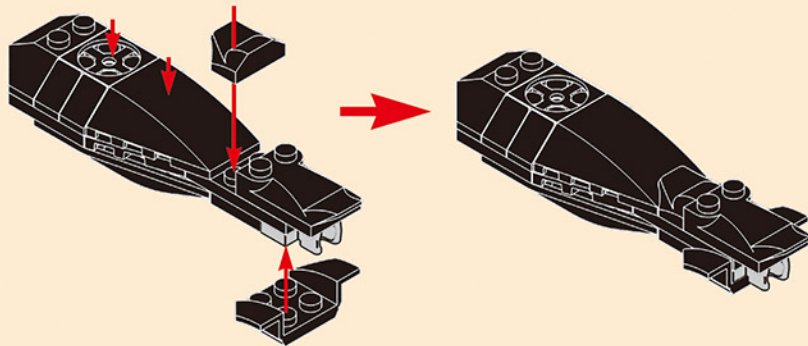

8-32

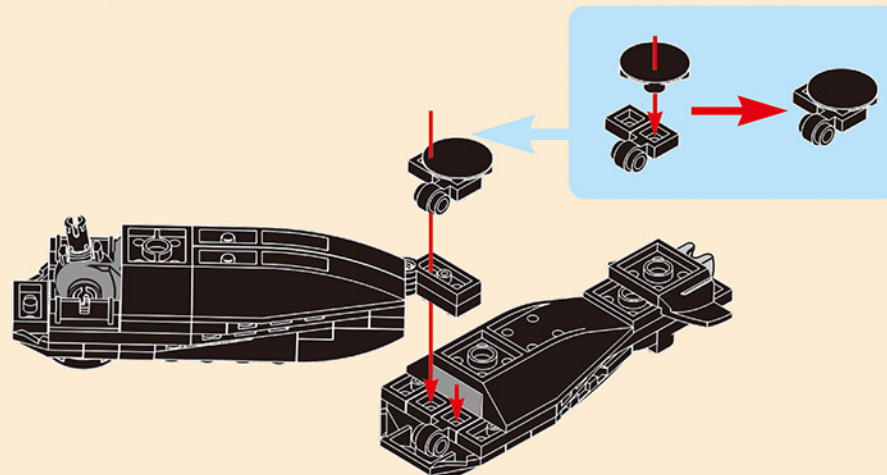

8-33

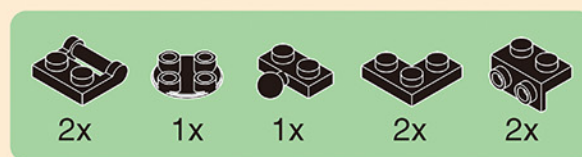
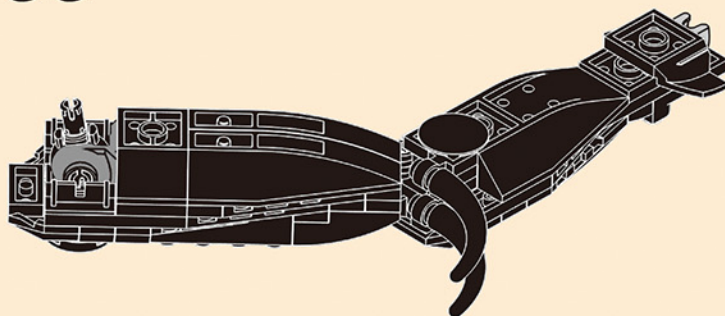

8-34

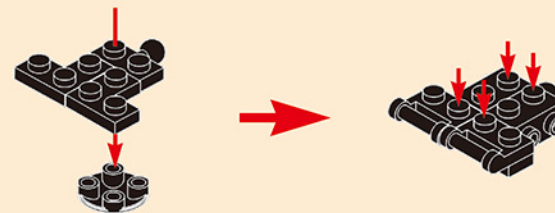

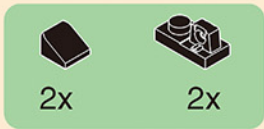

8-35

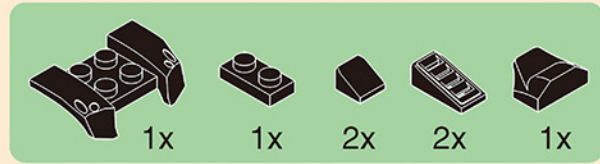
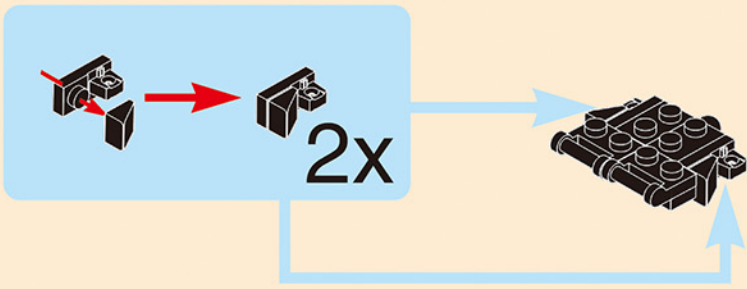

8-36

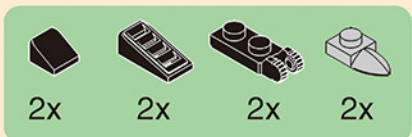
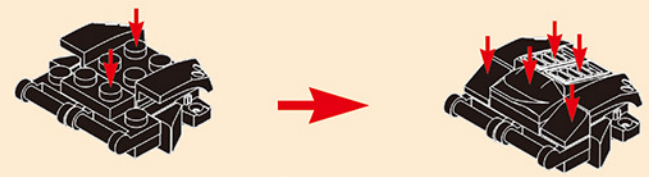

8-37

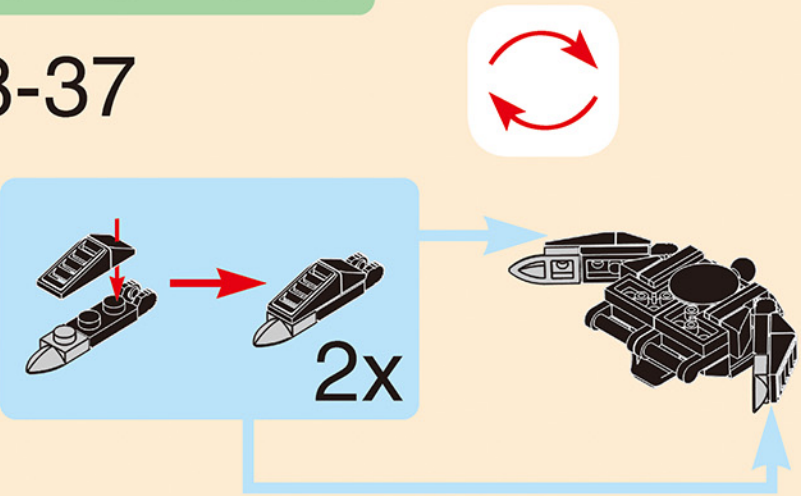

8-38

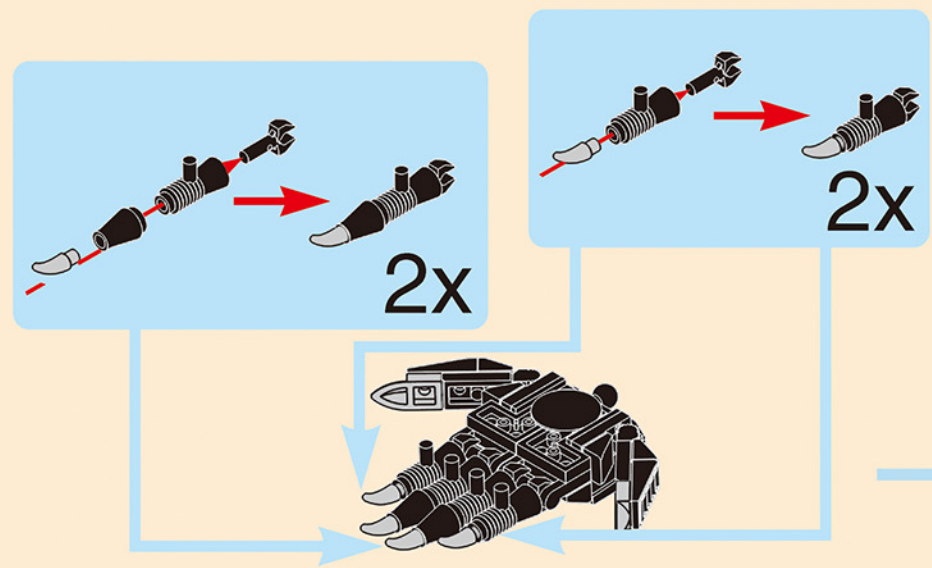

8-39

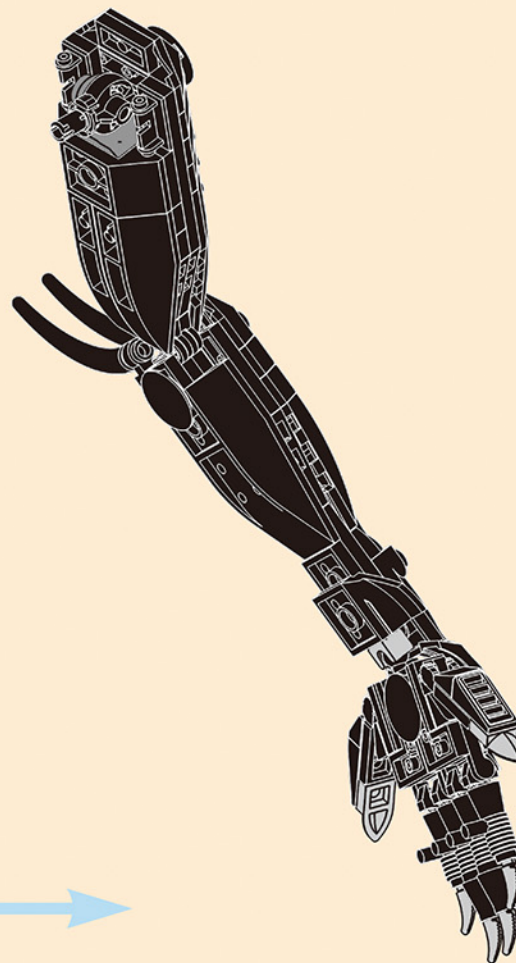

9-1

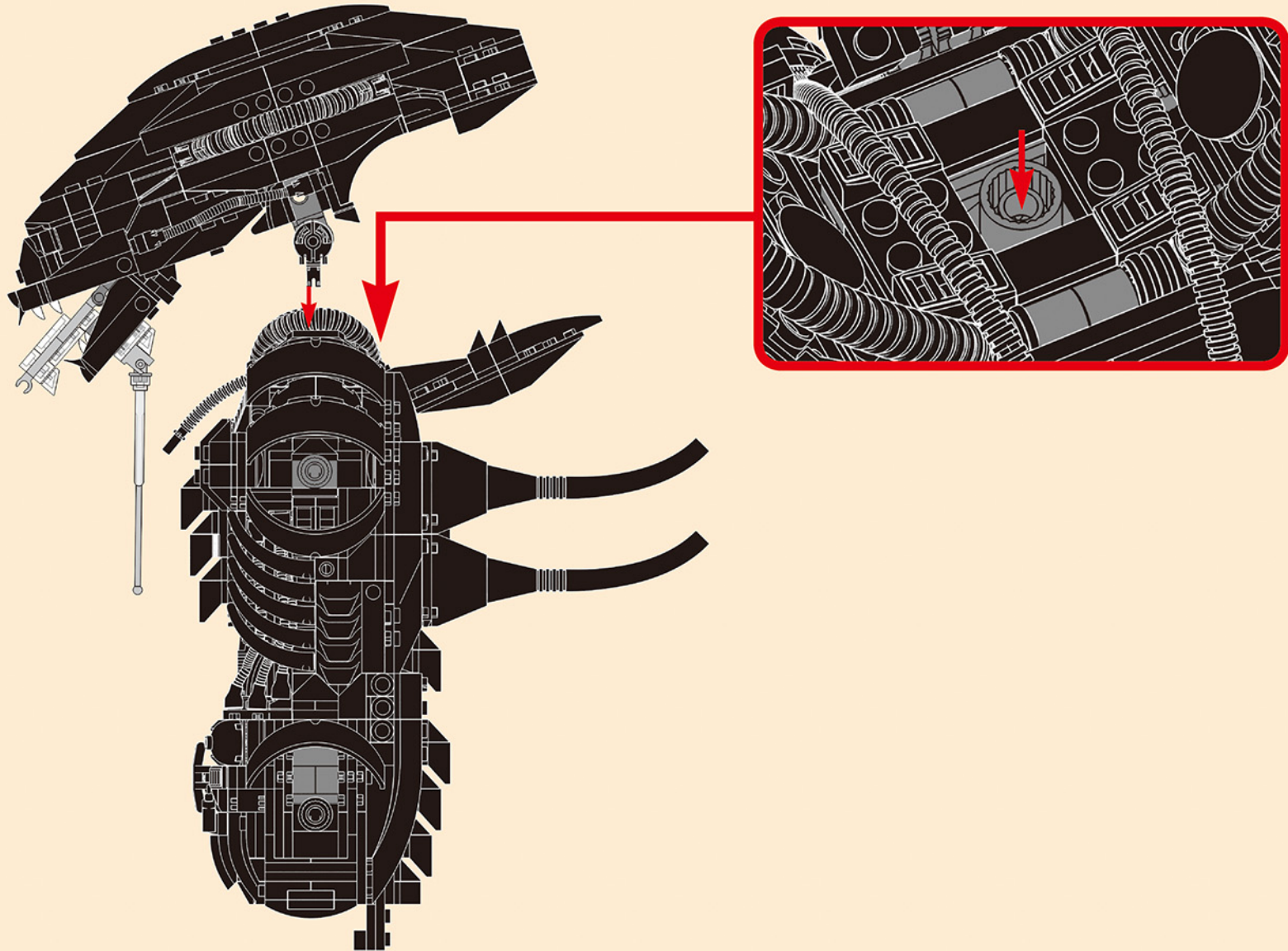

9-2

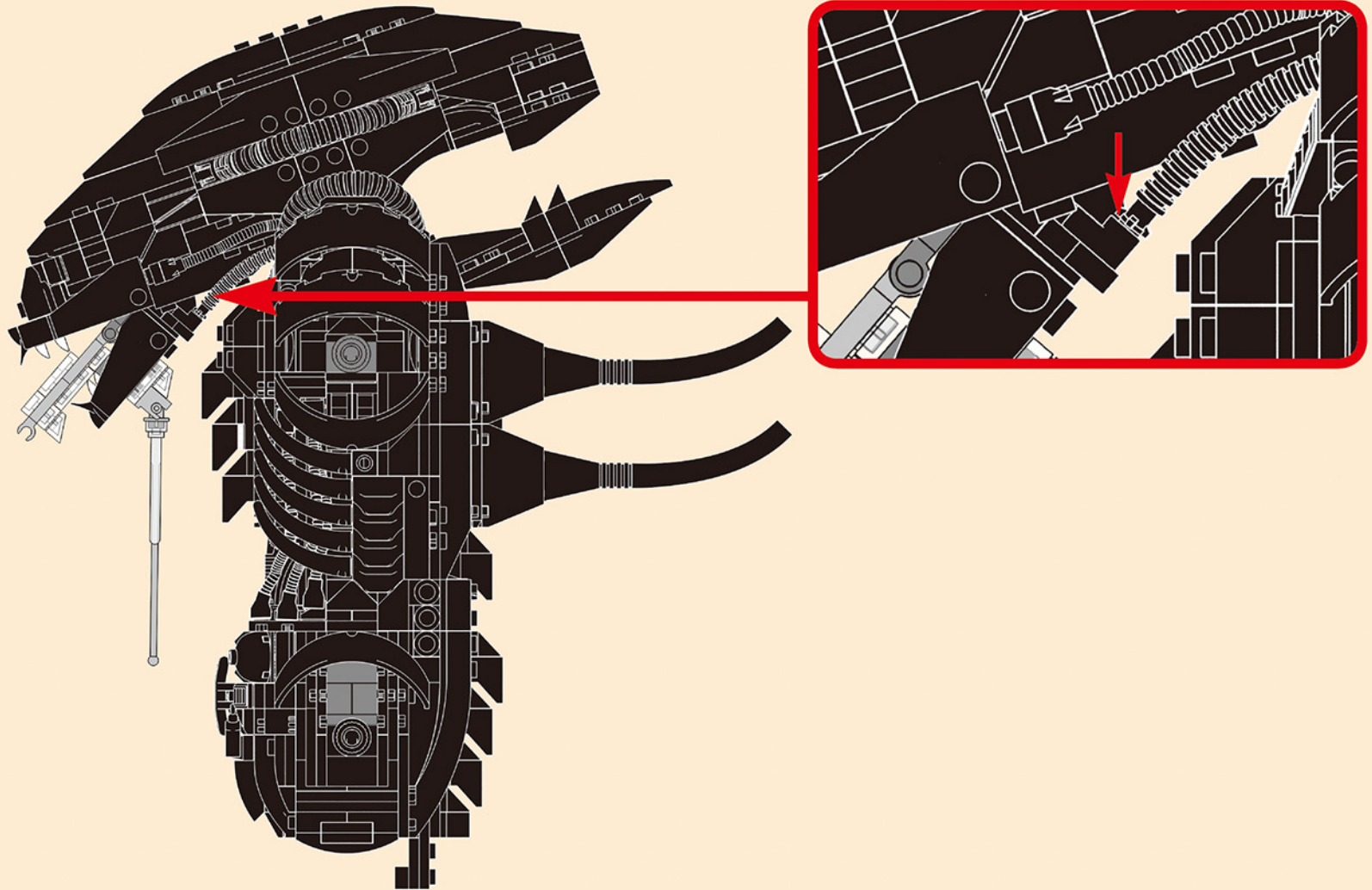

9-3

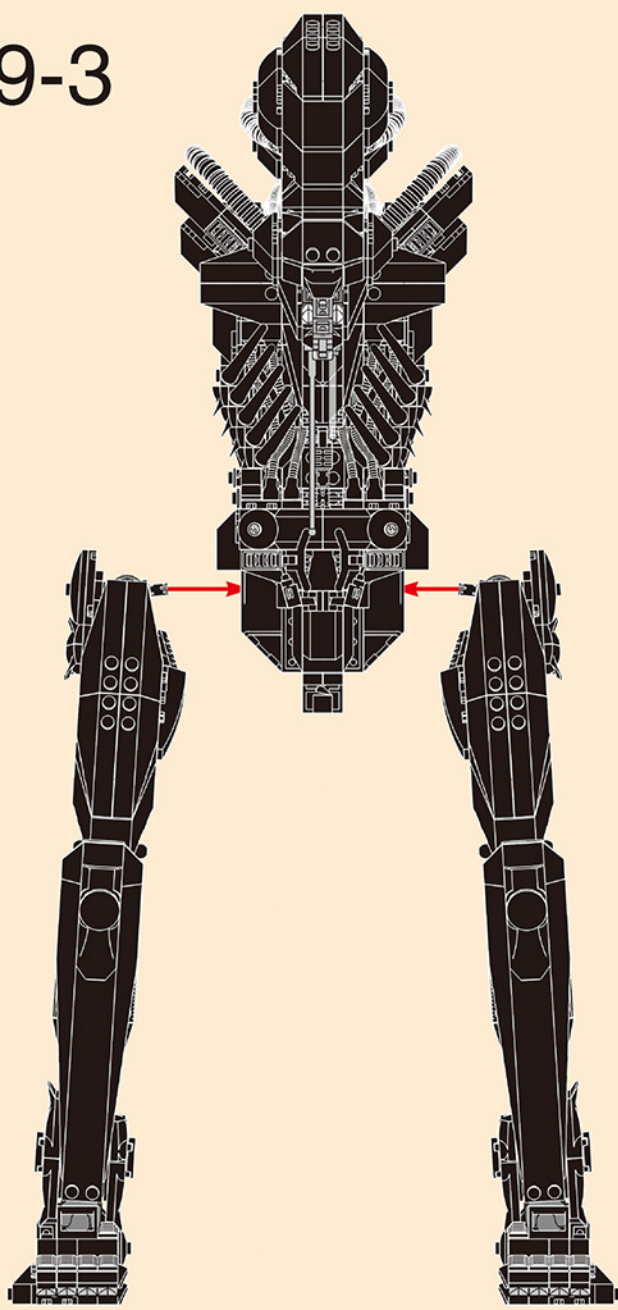

9-4

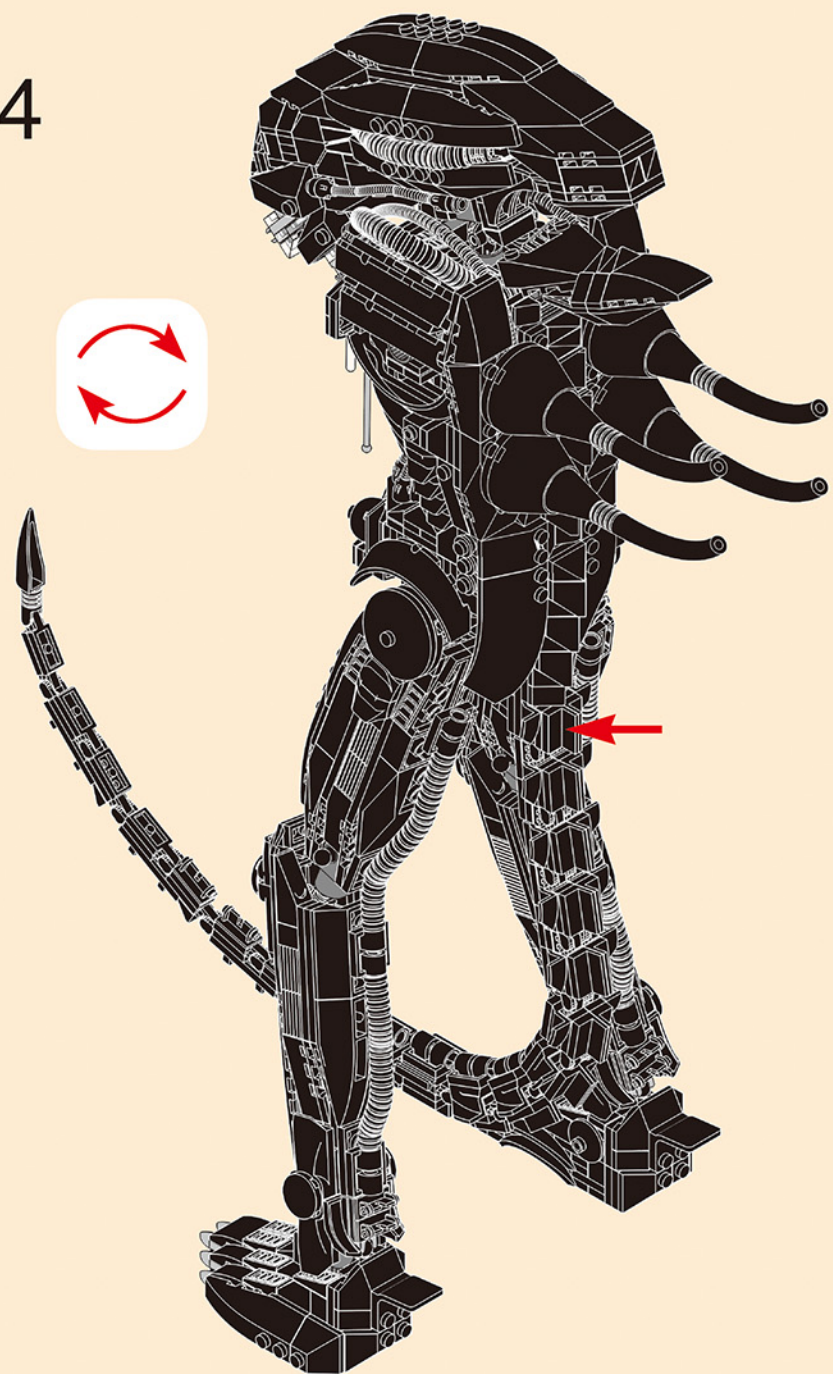

9-5

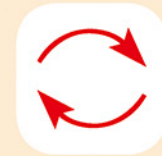
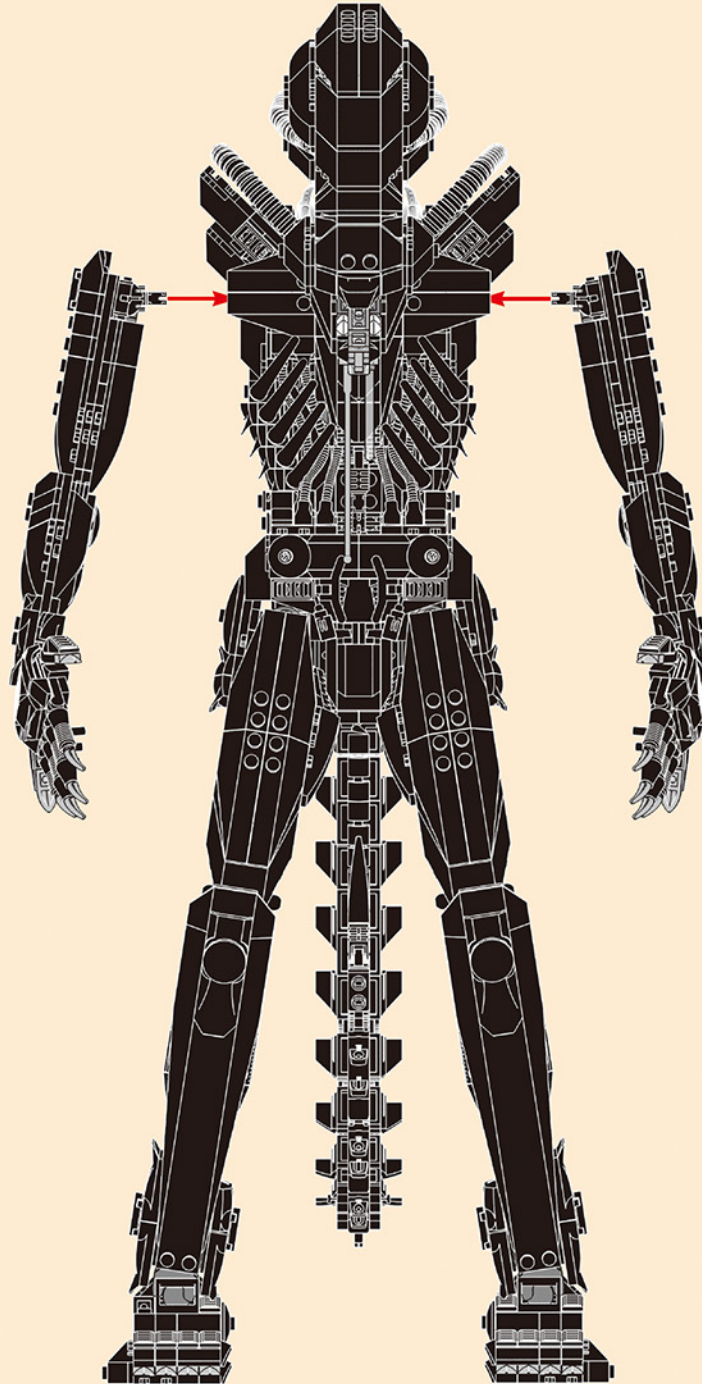

9-6

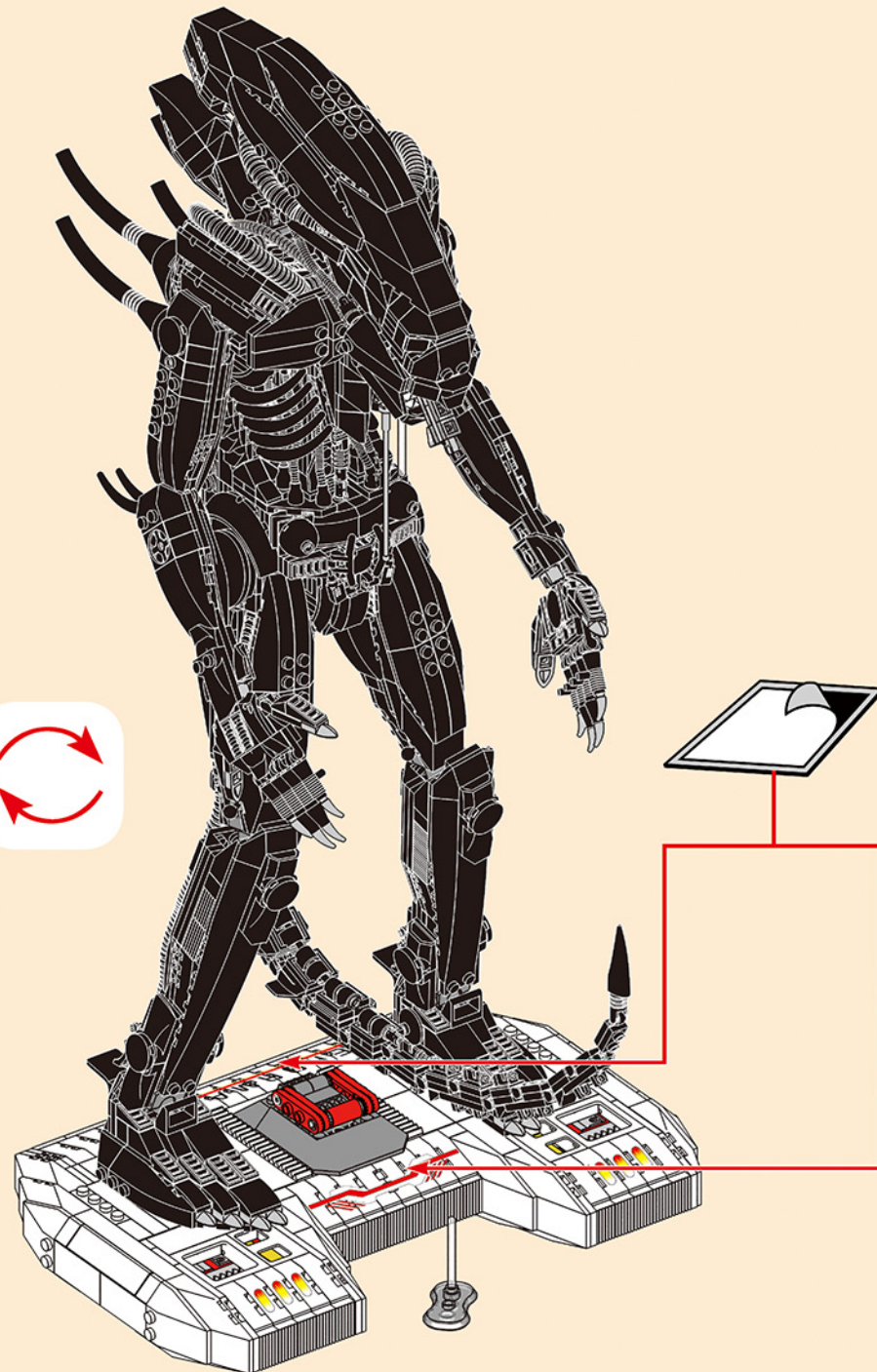
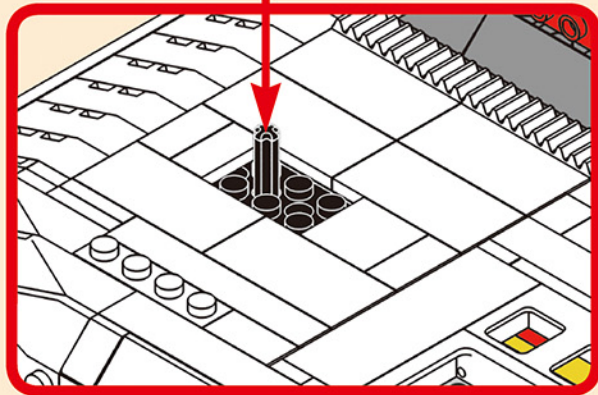
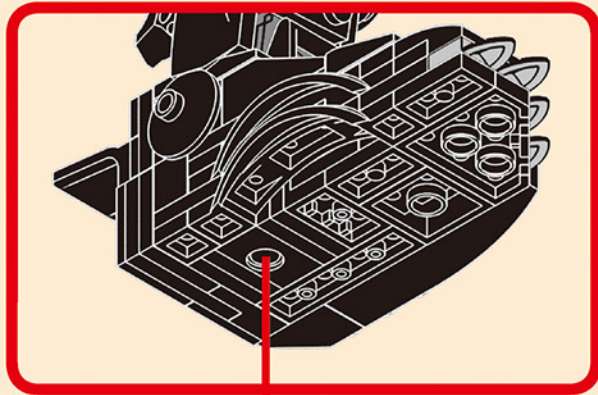

A

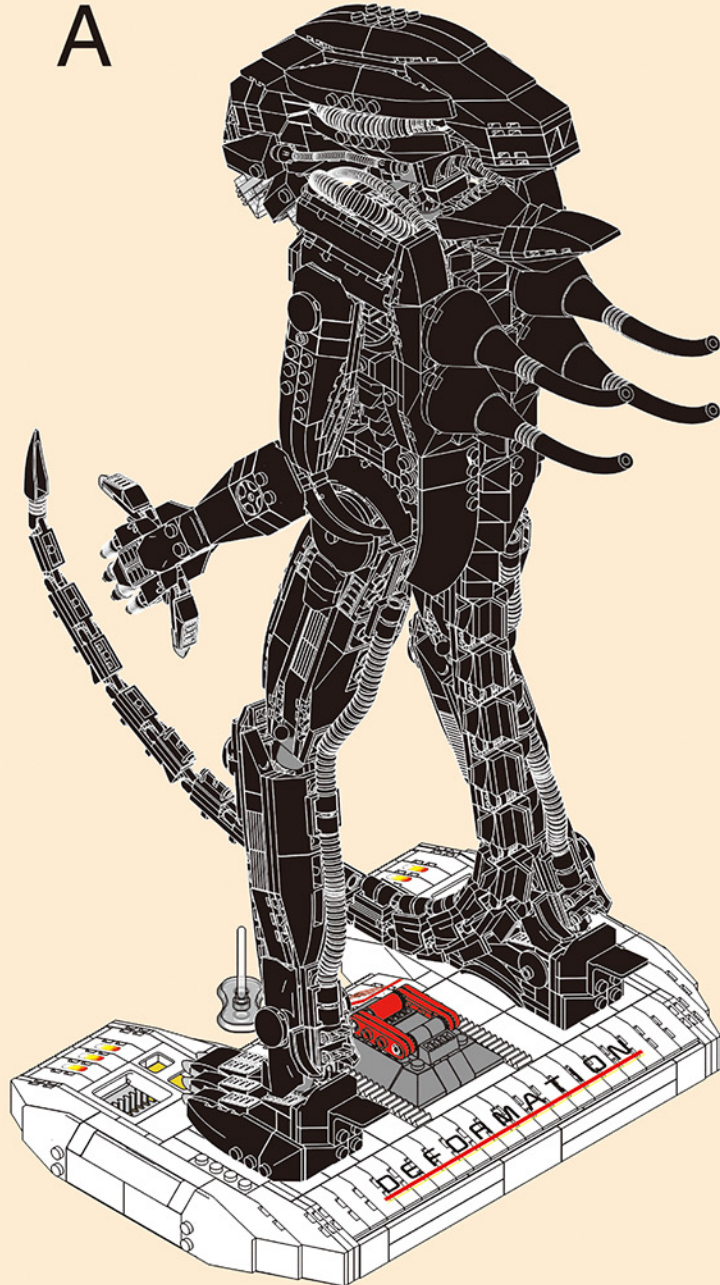

B

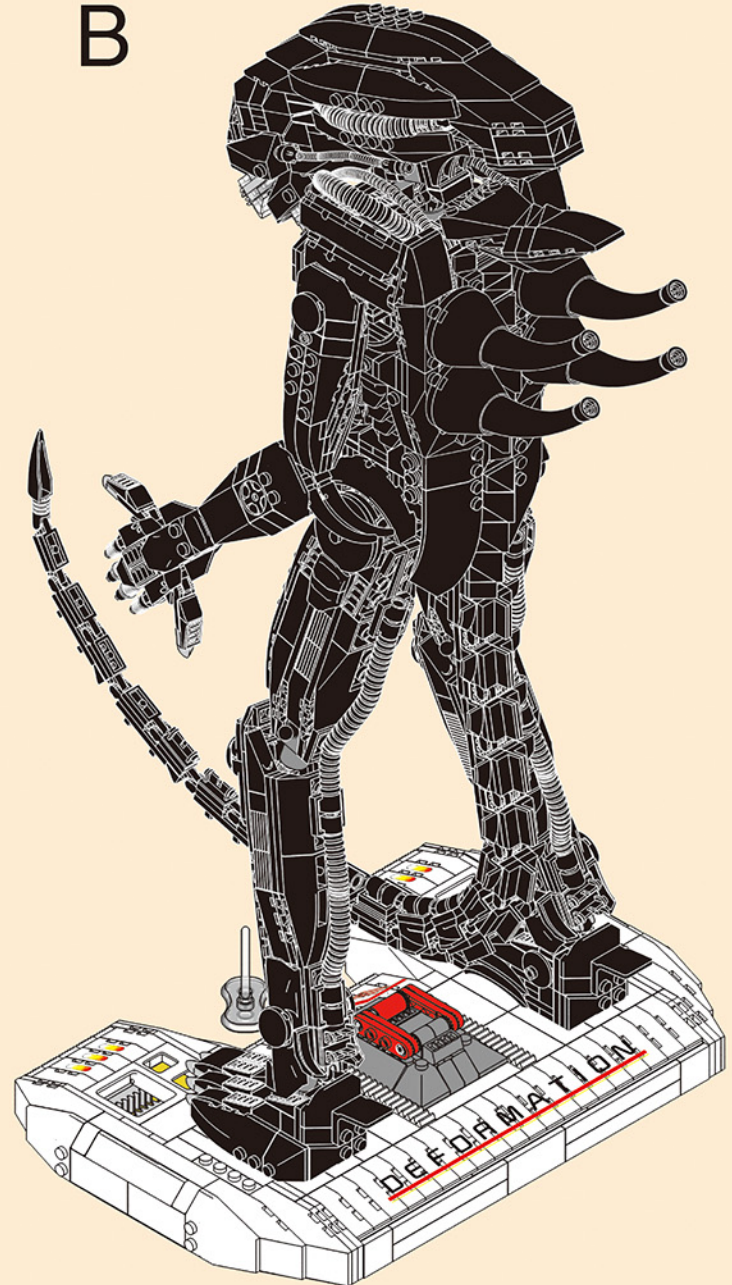



ALSENS

