

1-1

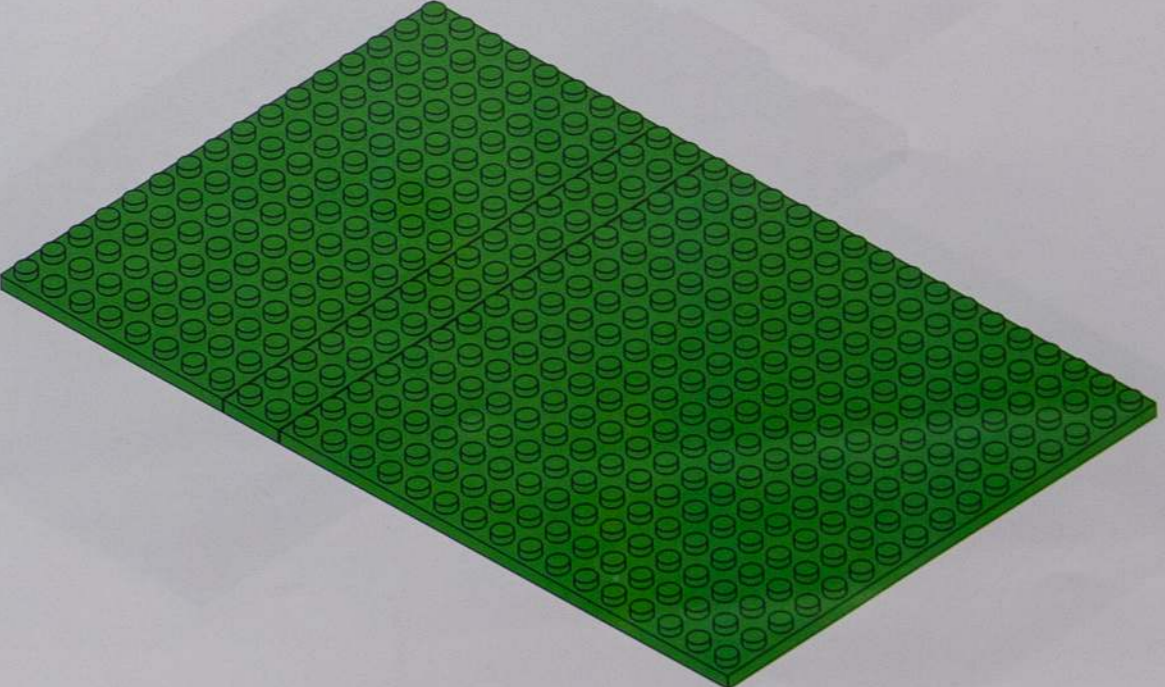

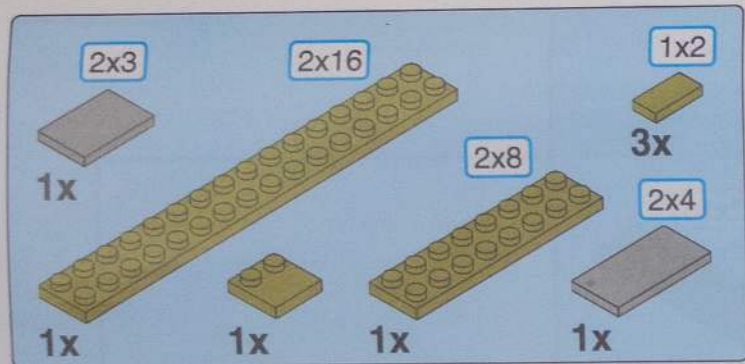

1-2

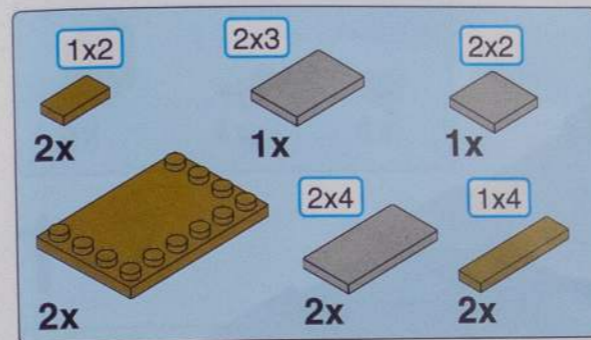
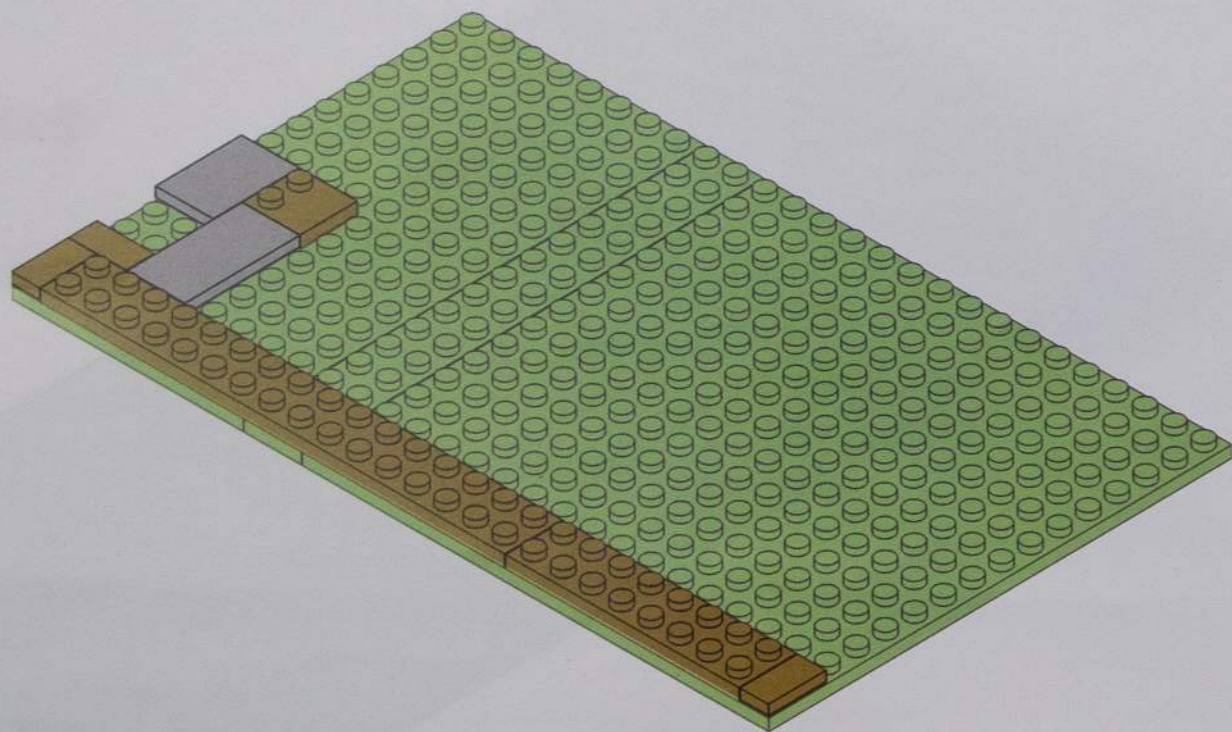

1-3

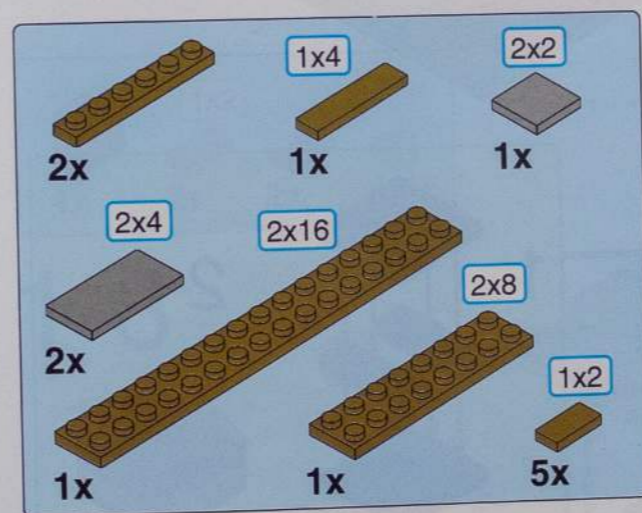
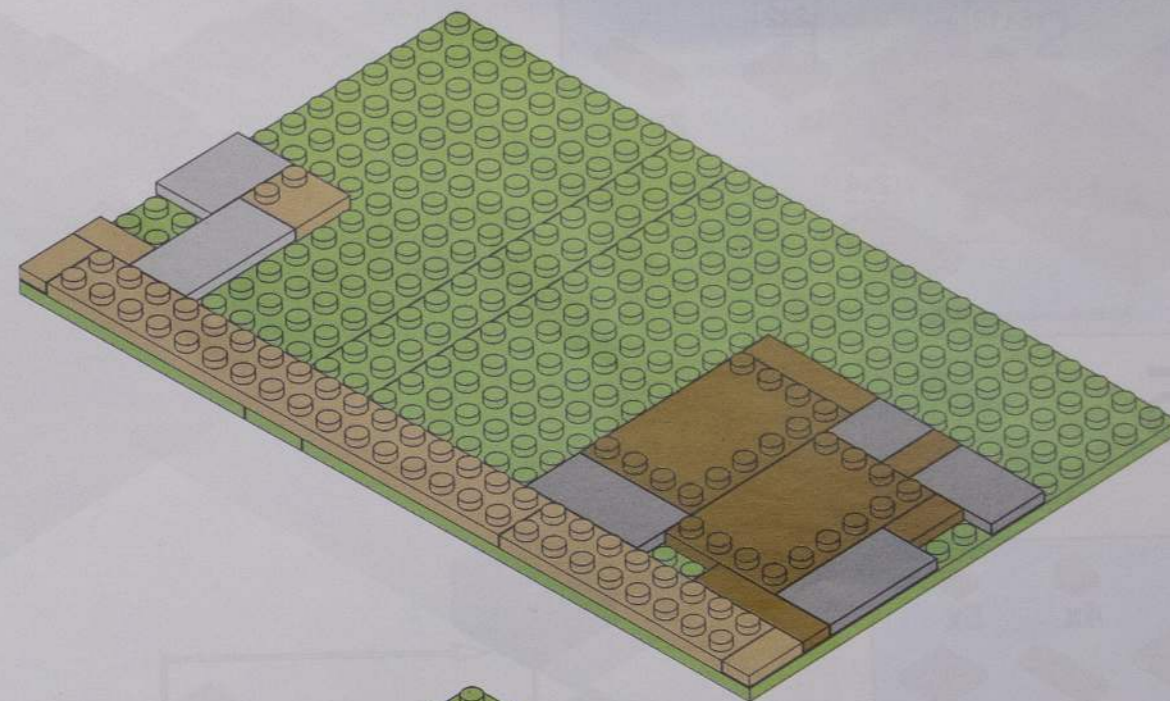

1-4



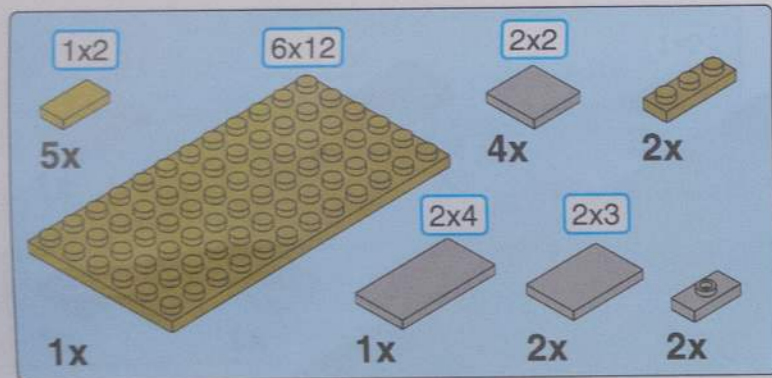

1-5

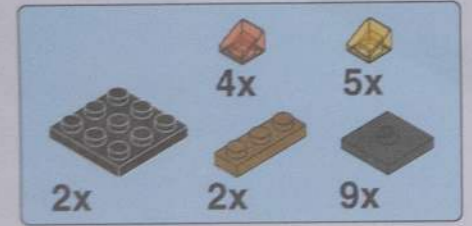
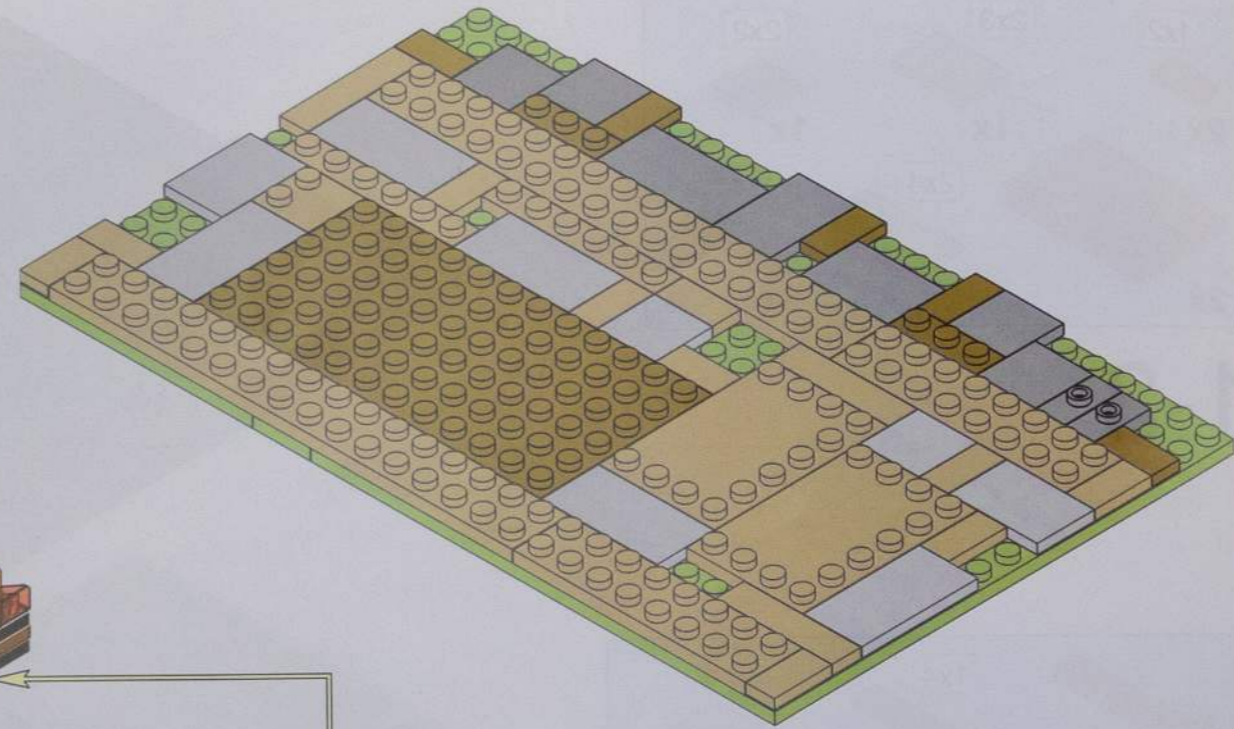

1-6

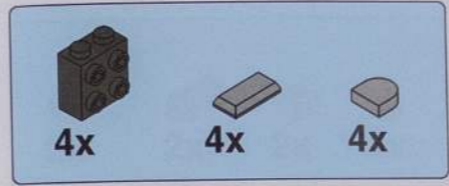
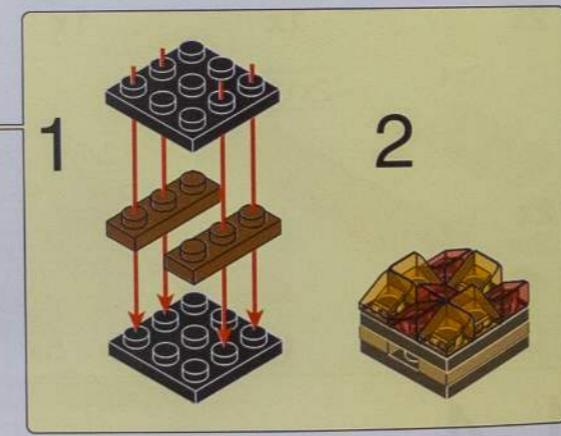
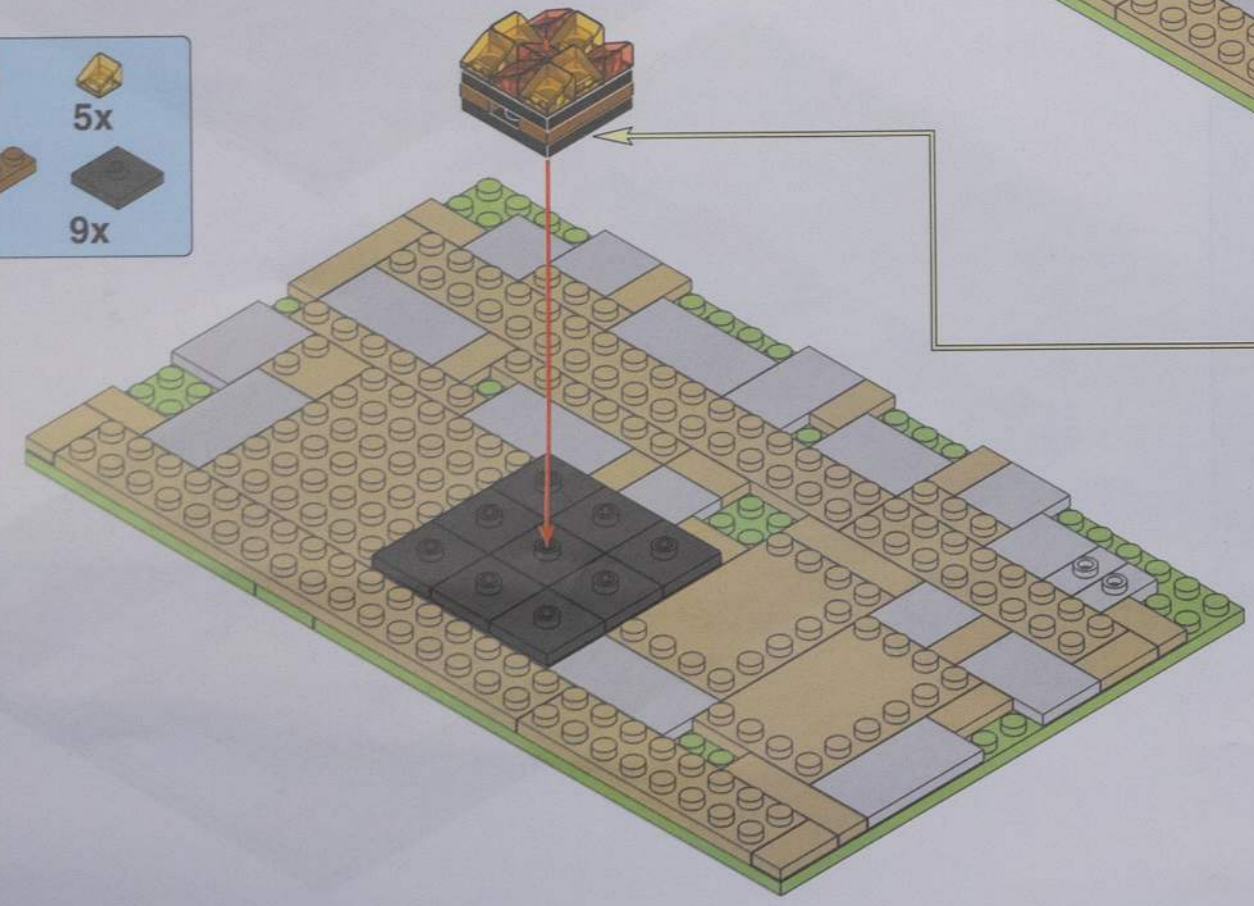

1-7

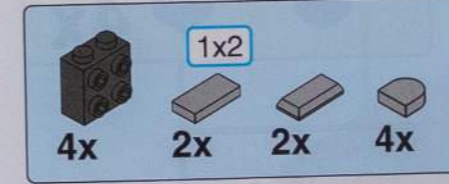
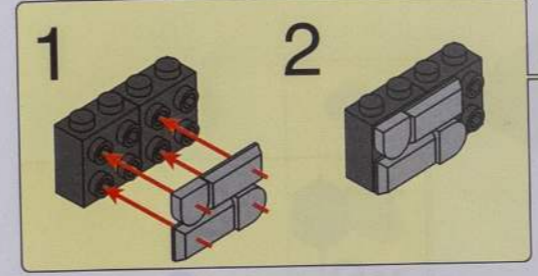

1-8

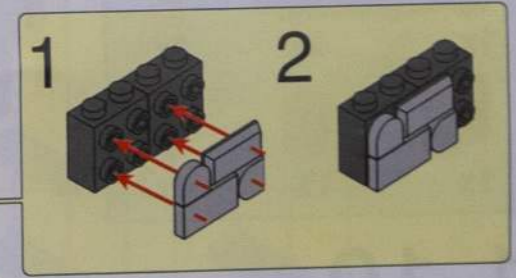
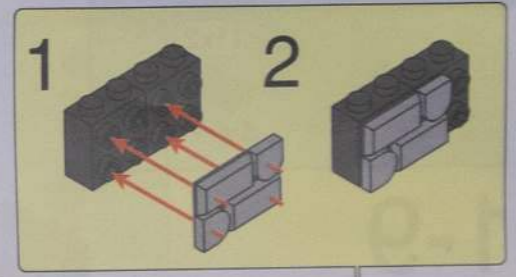
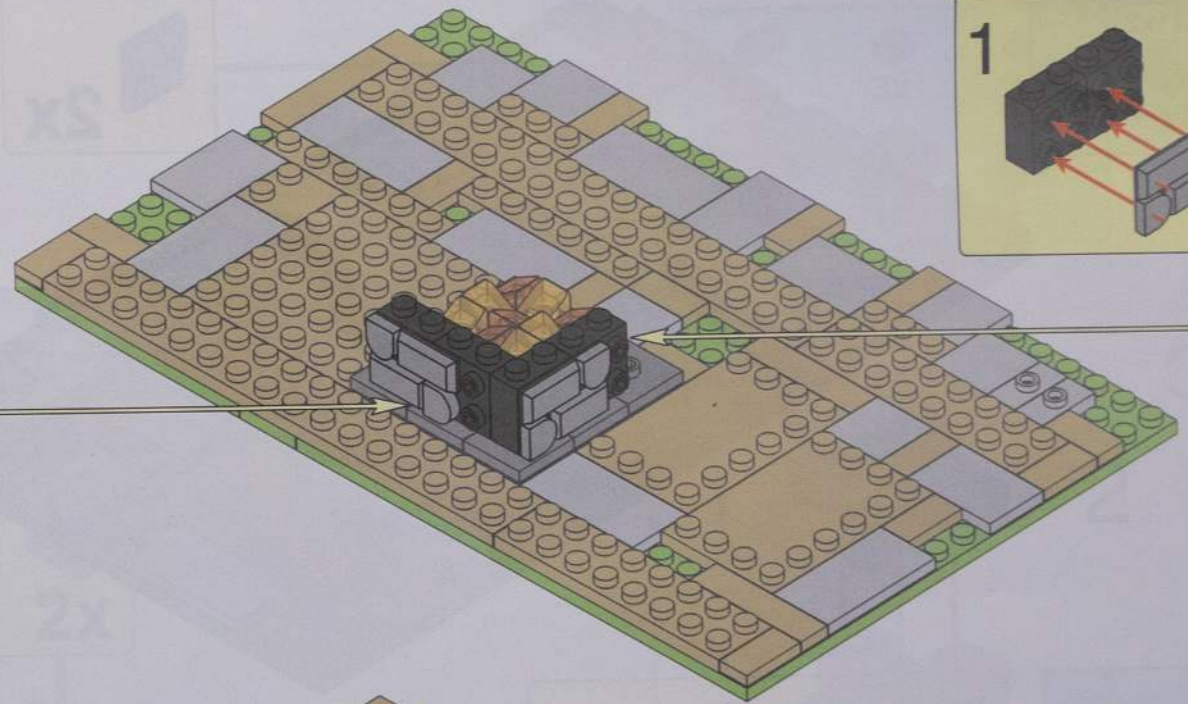
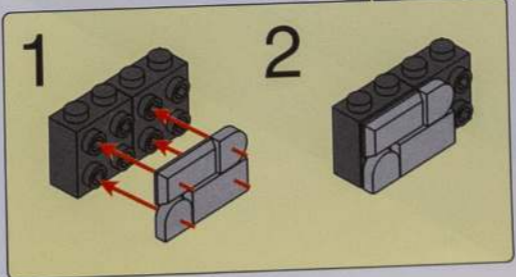

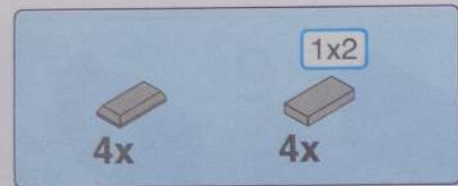

1-9

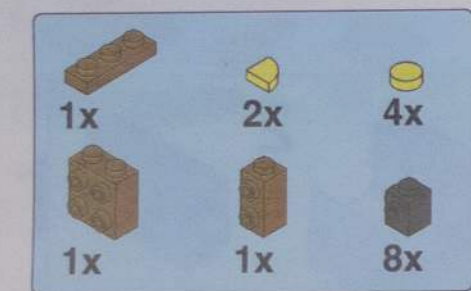
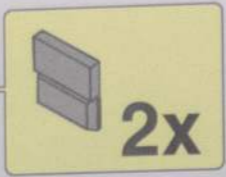
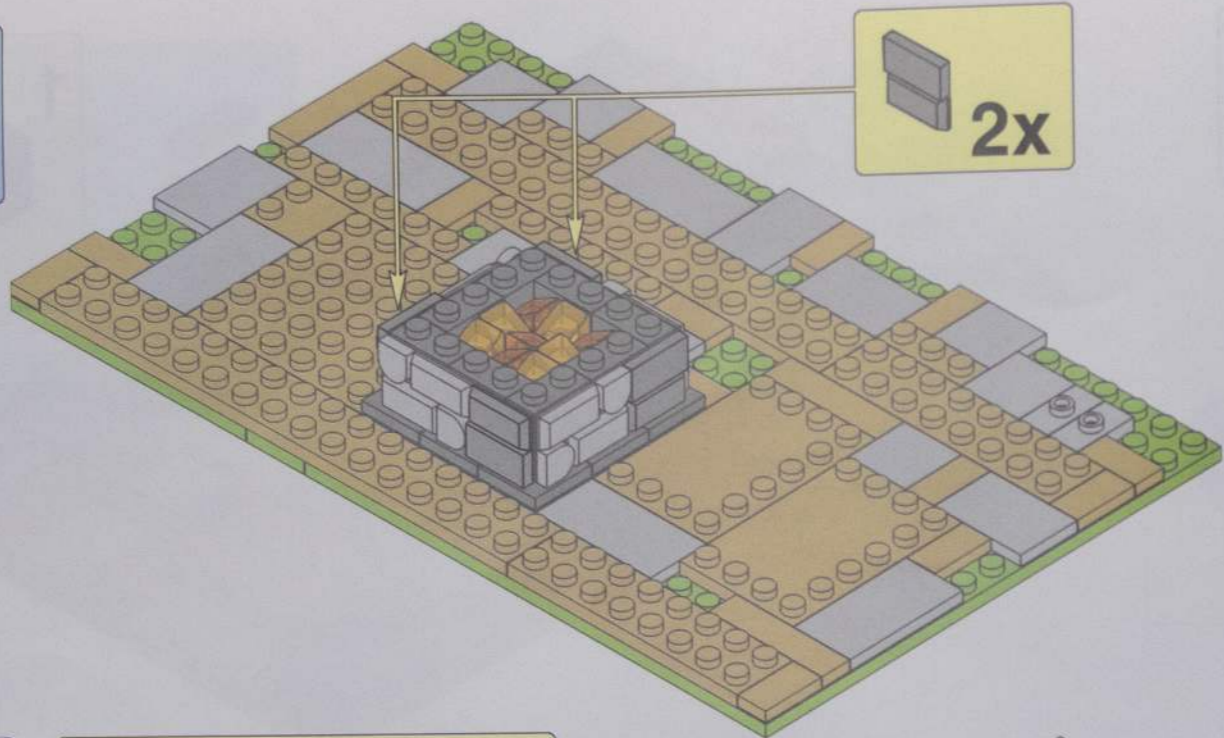

1-10

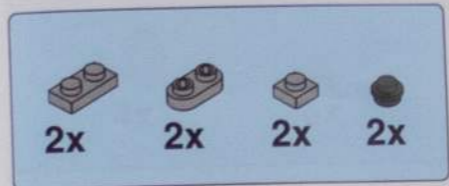
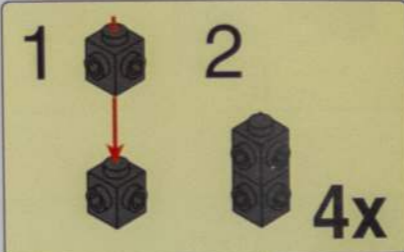
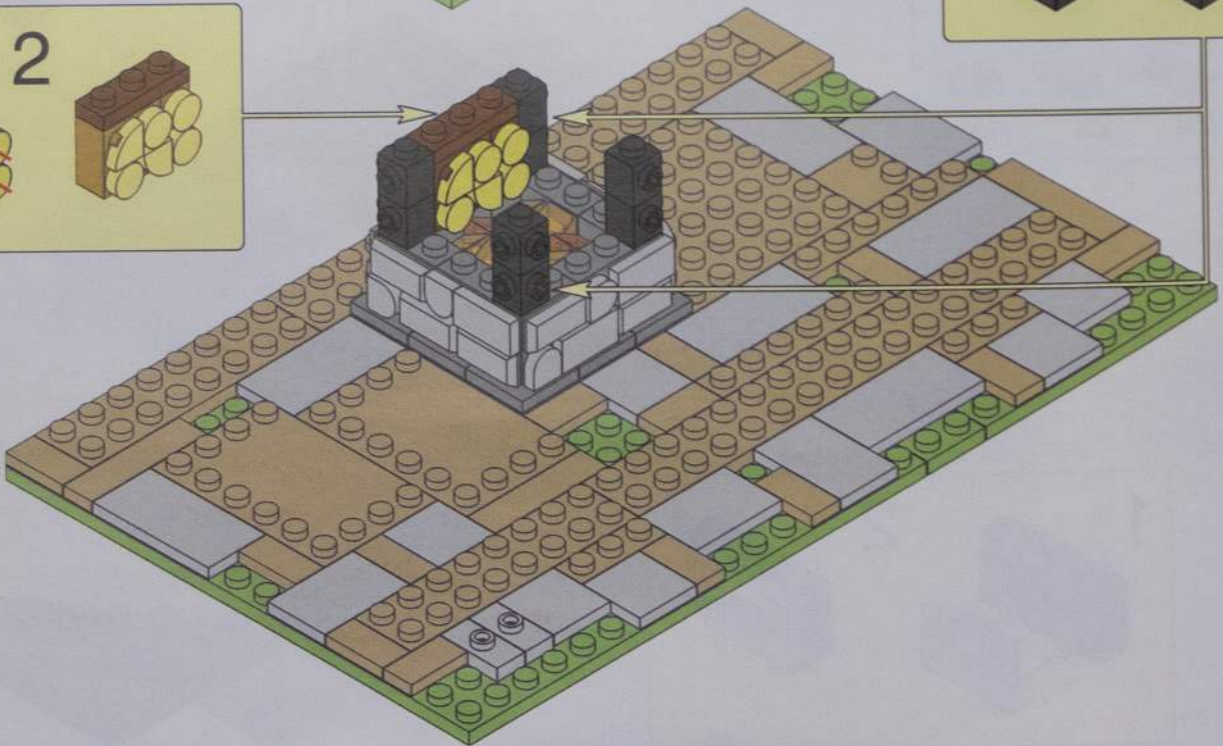
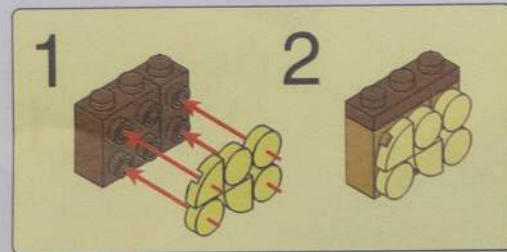

1-11

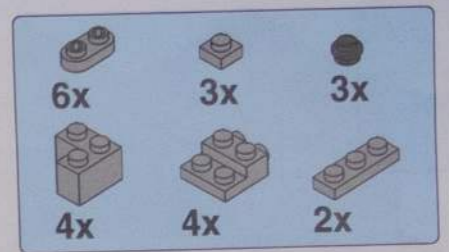
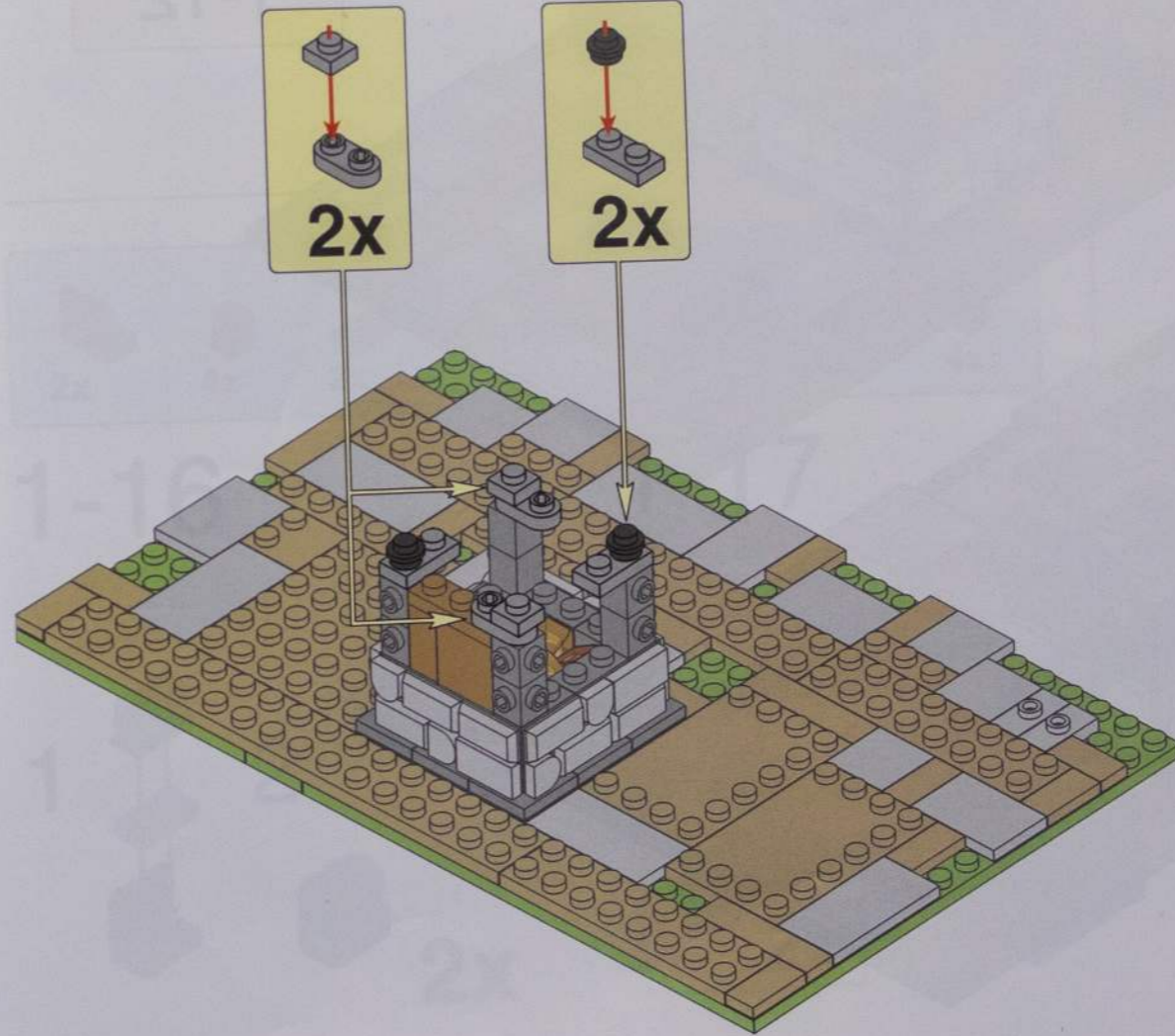

1-12

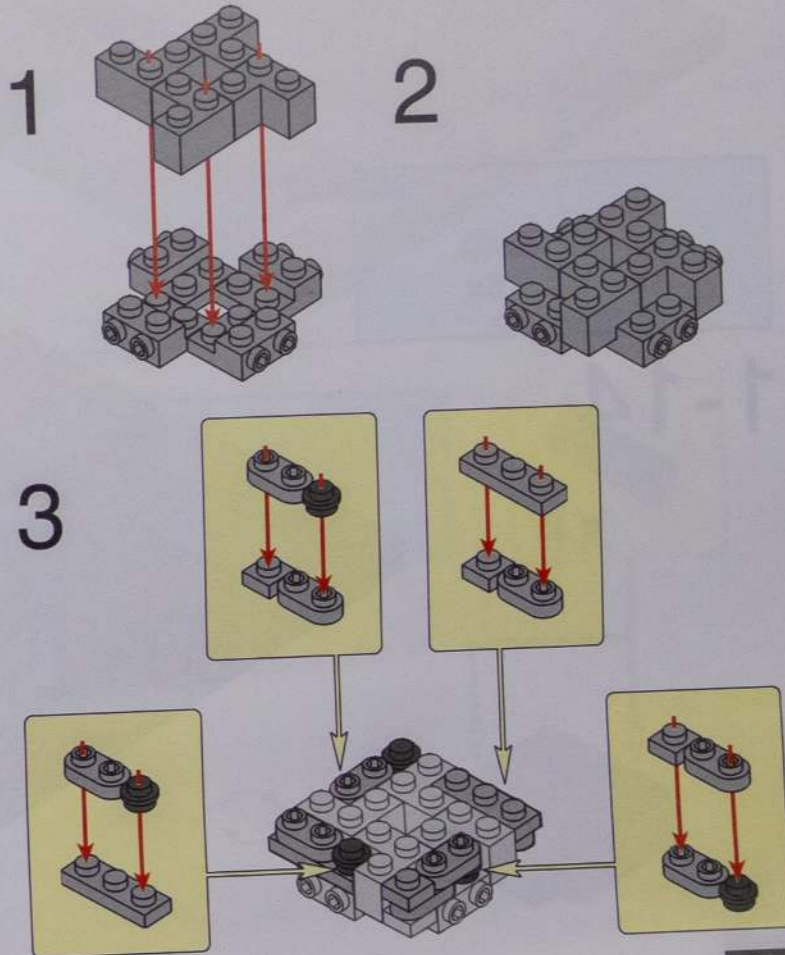

1

2

3

8

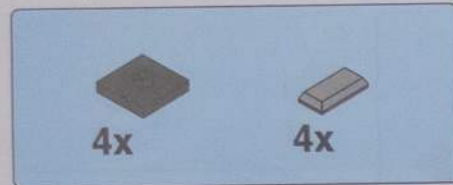

1-13

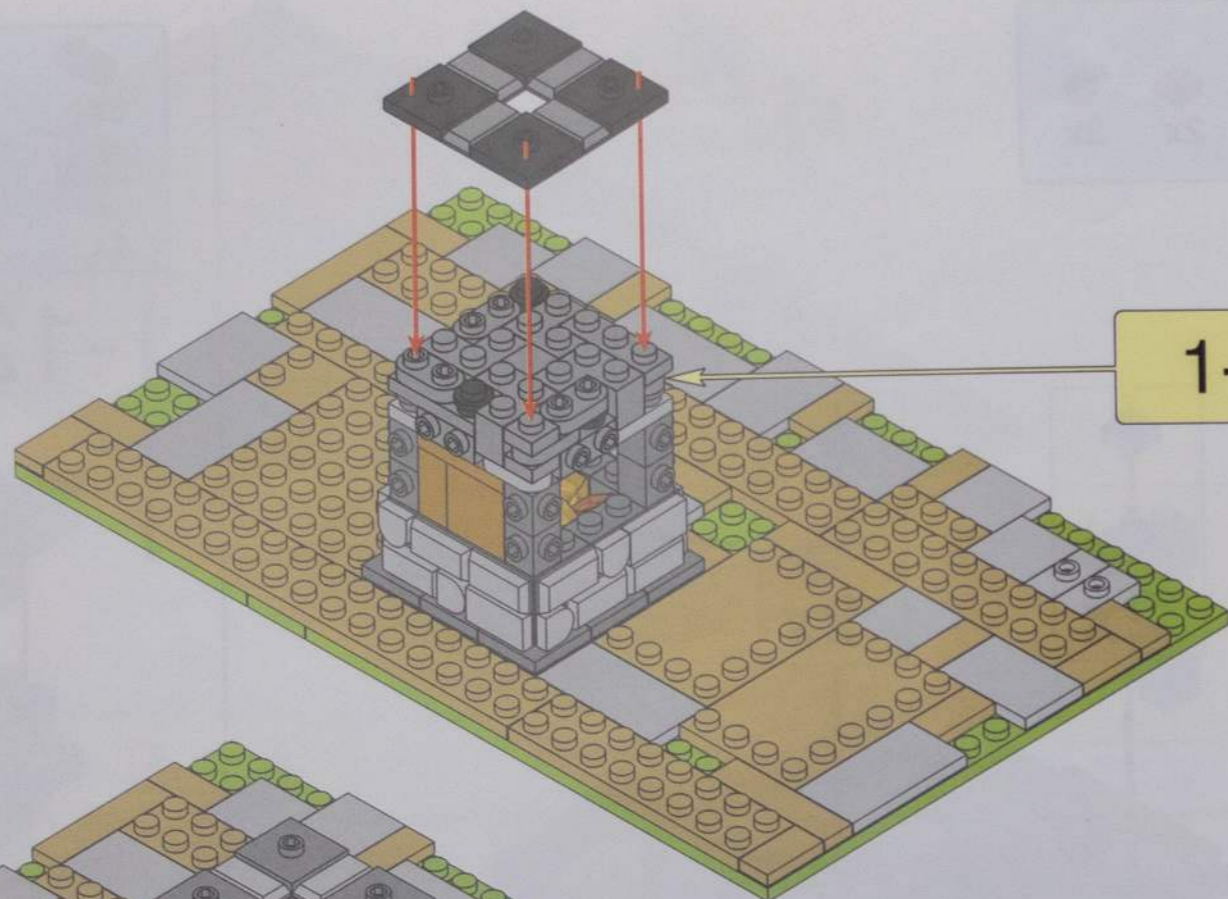

1-12

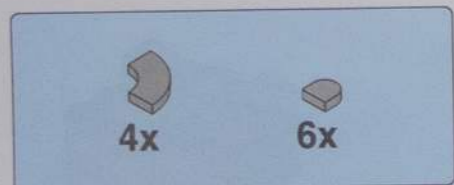

1-14

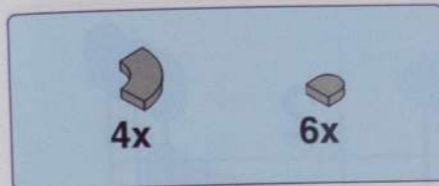

1-15

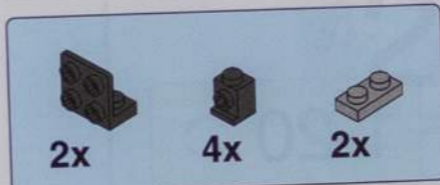
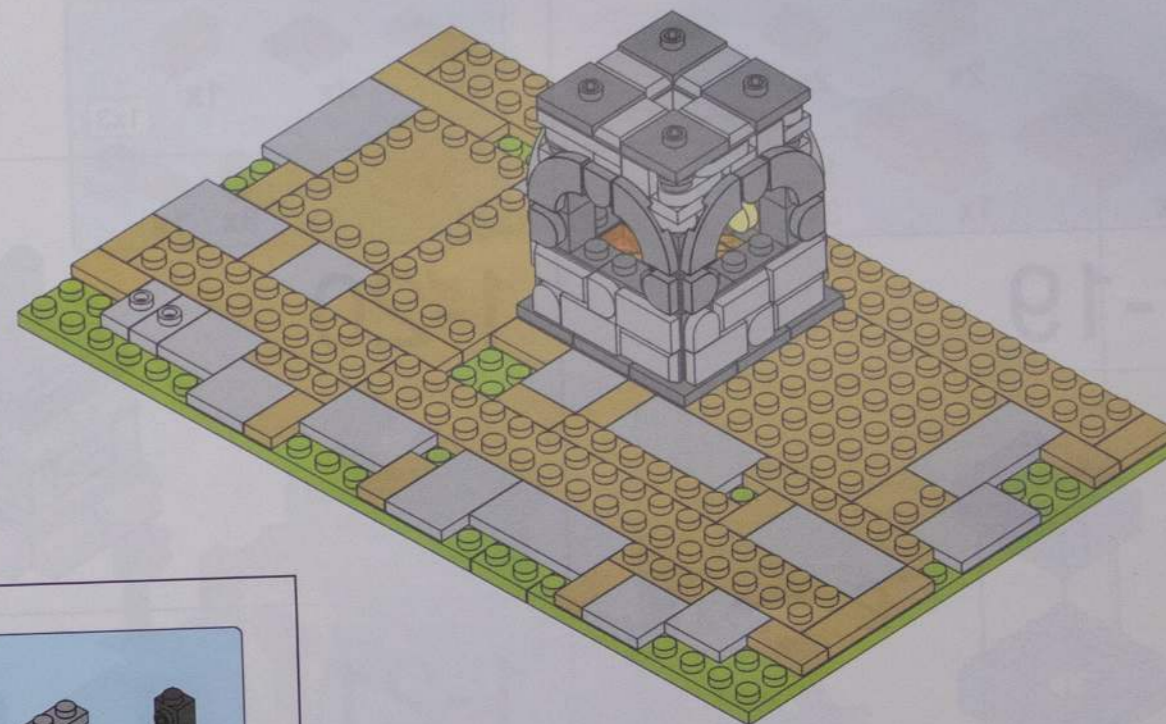

1-16

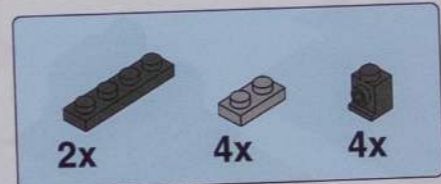
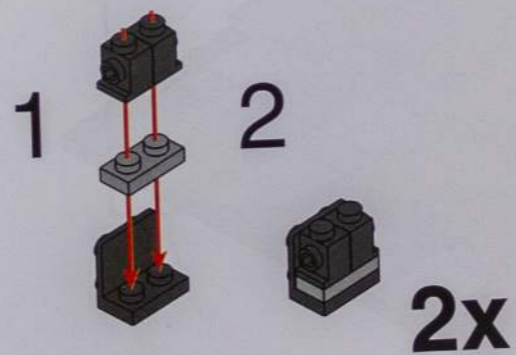

1-17

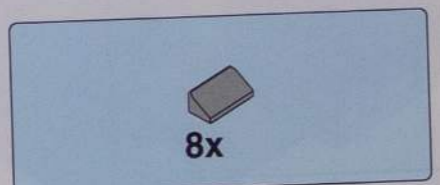
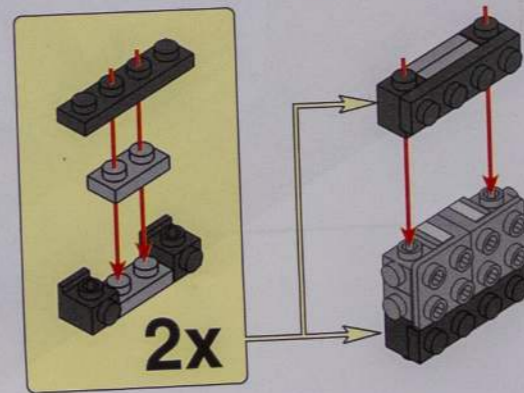

1-18

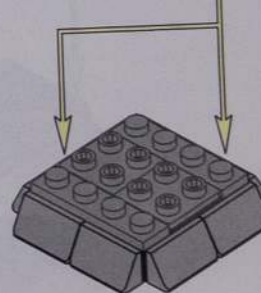
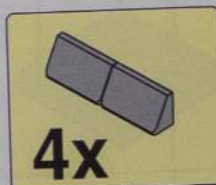

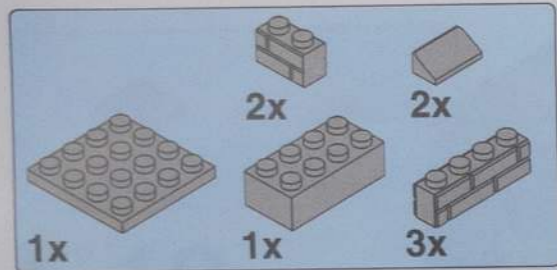

1-19

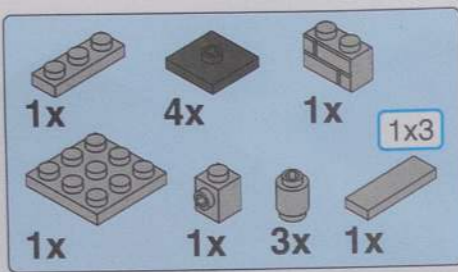
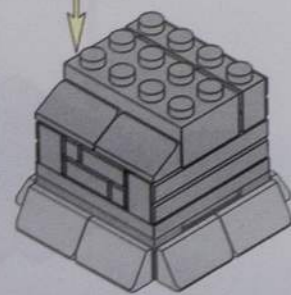
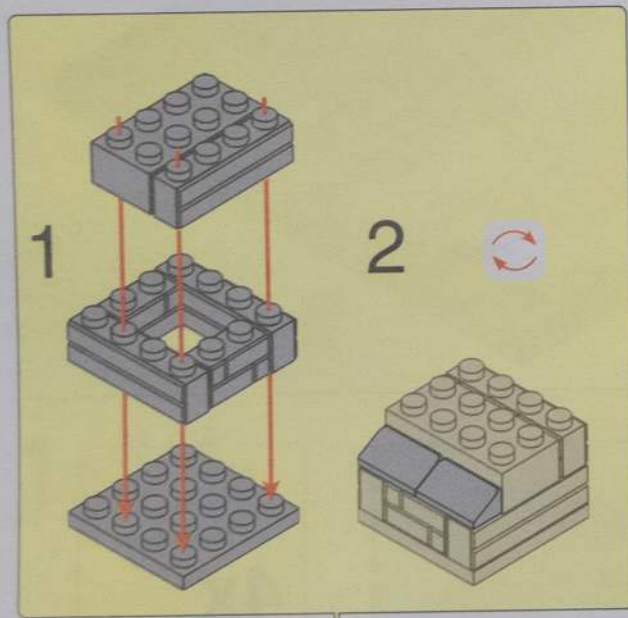

1-20

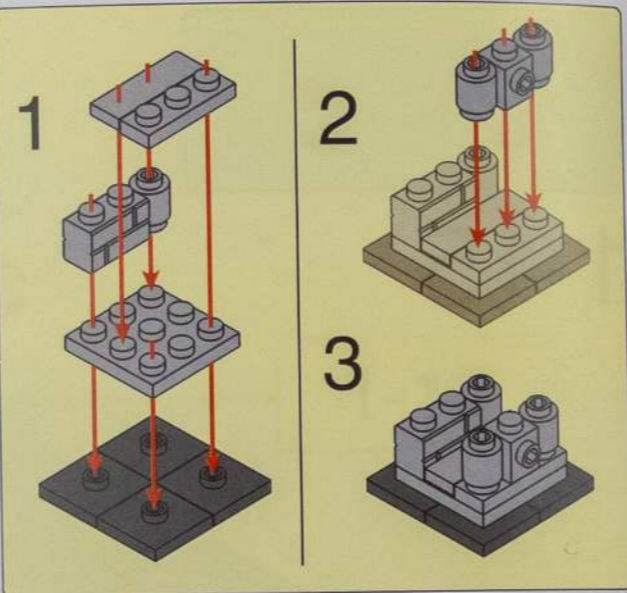
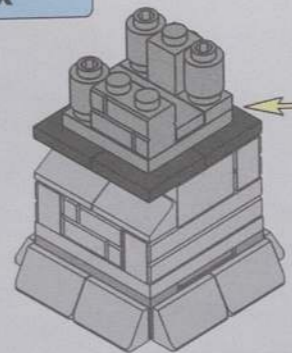

1-21

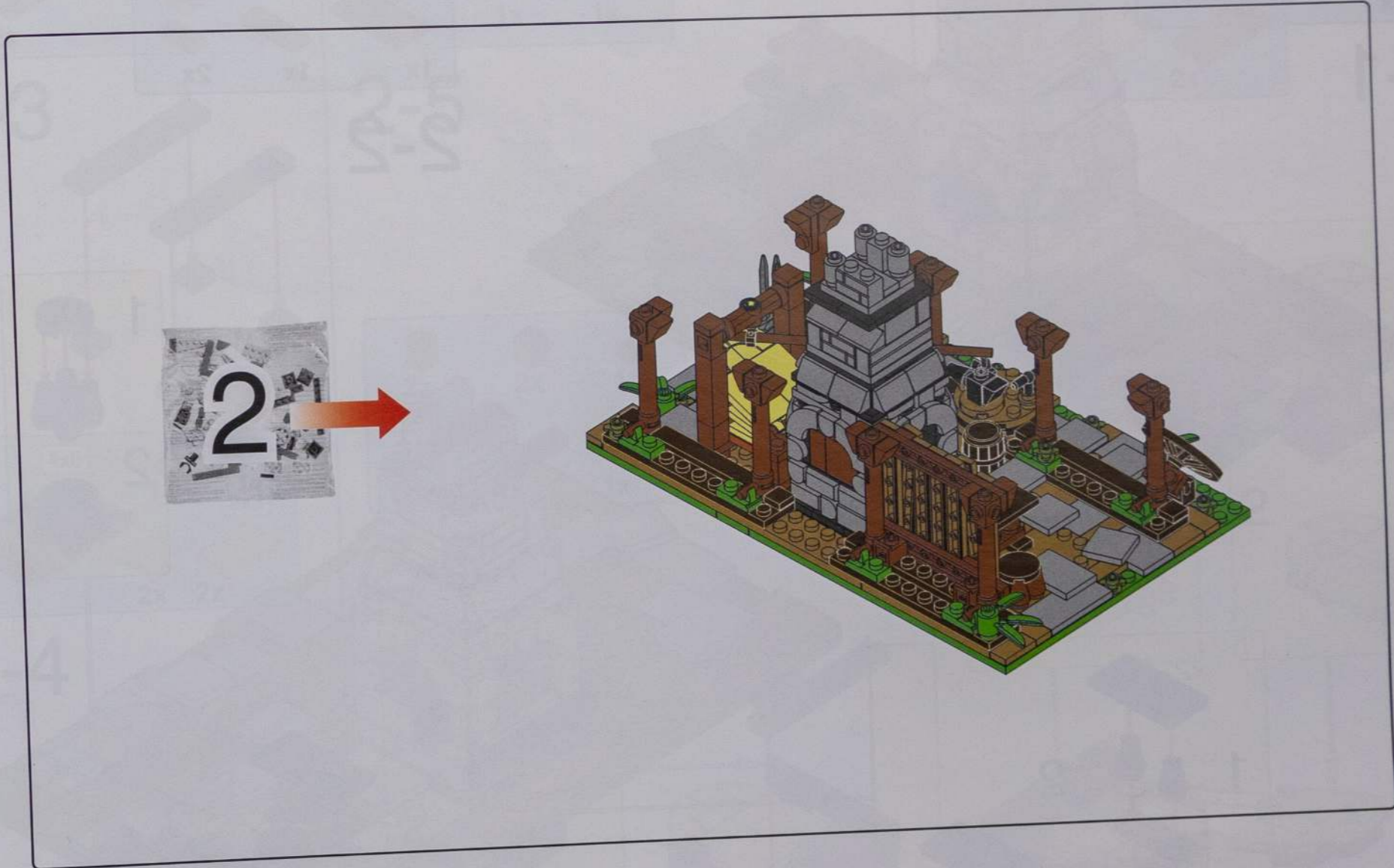
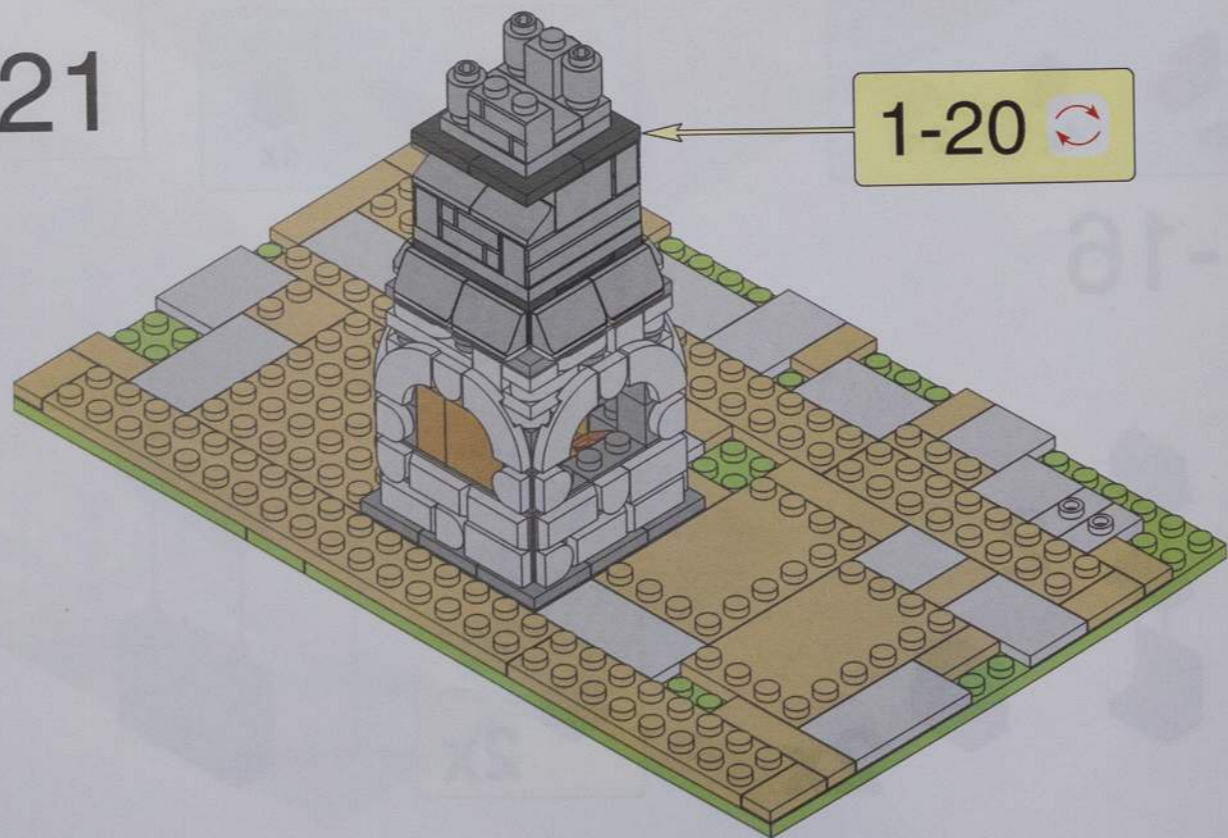

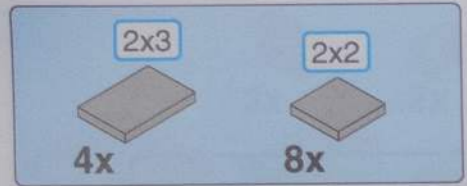

2-1

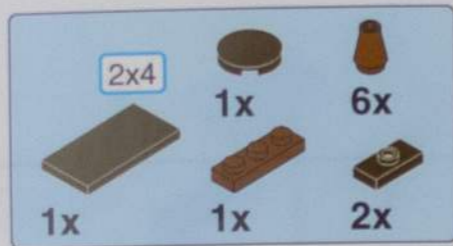
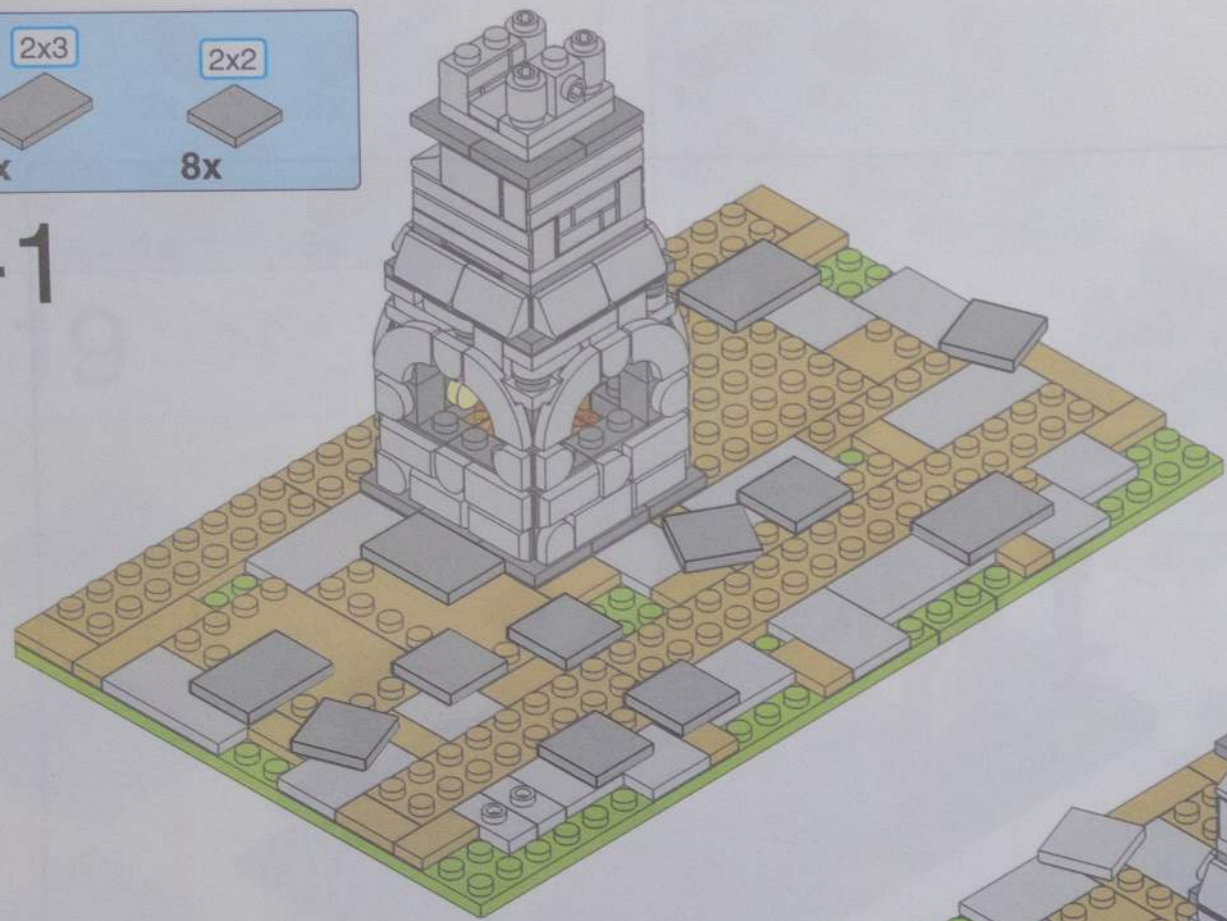

2-2

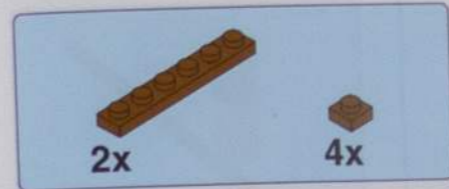
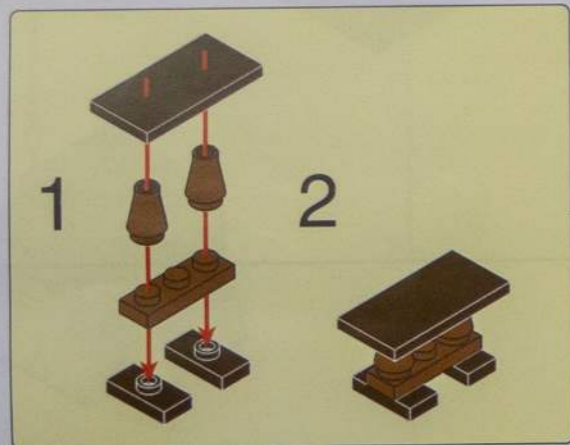
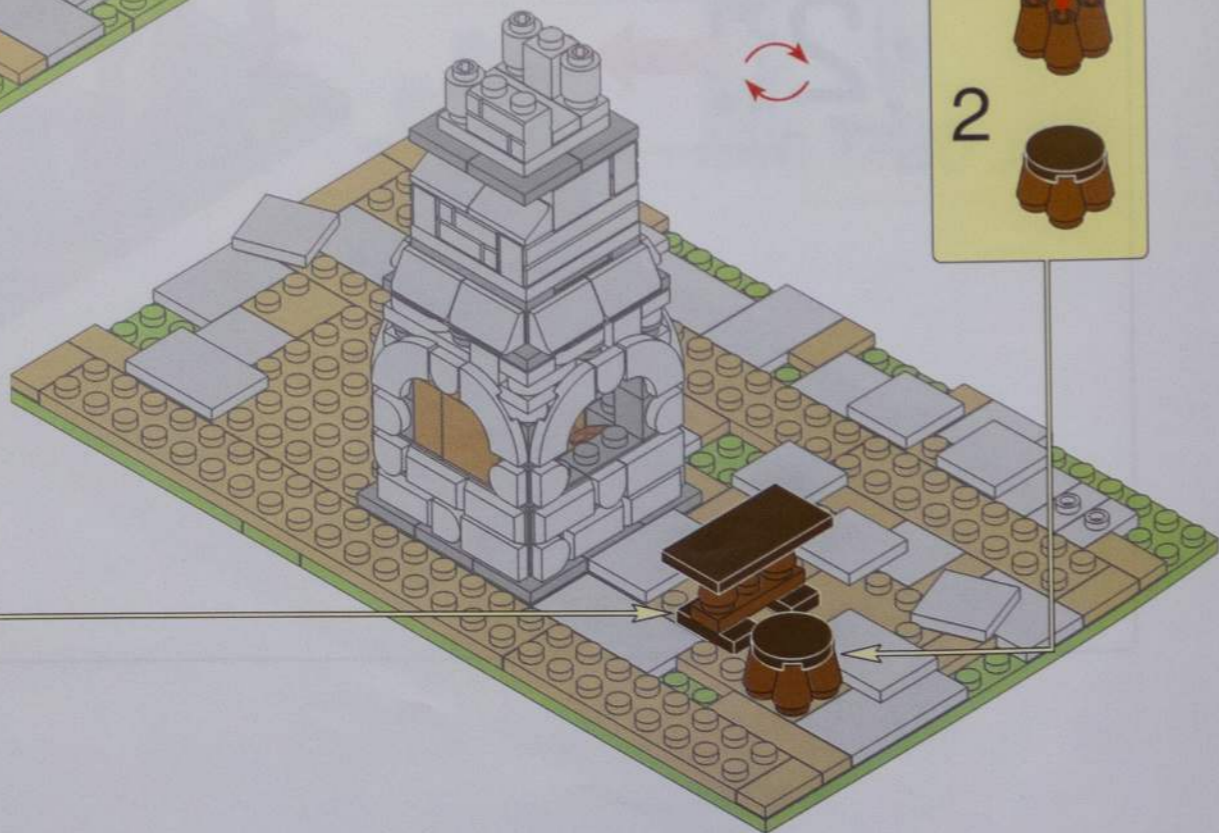

2-3

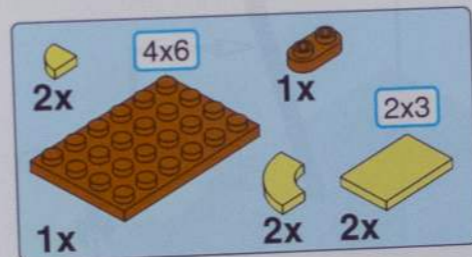
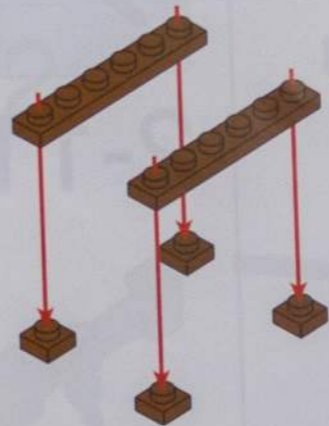

2-4

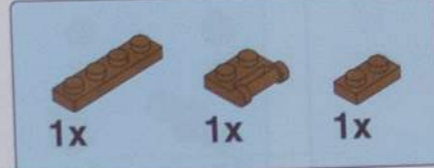
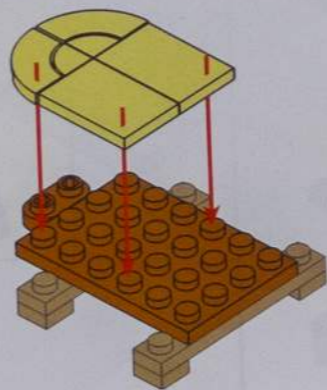

2-5

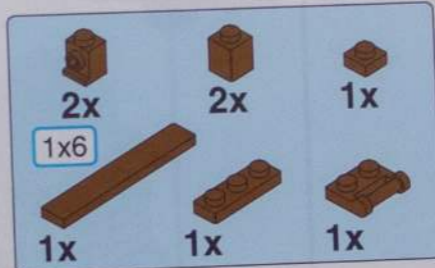
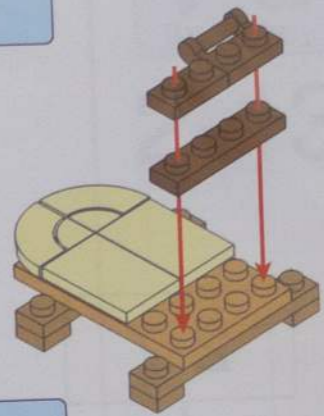

2-6

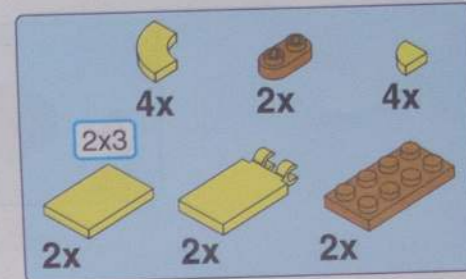
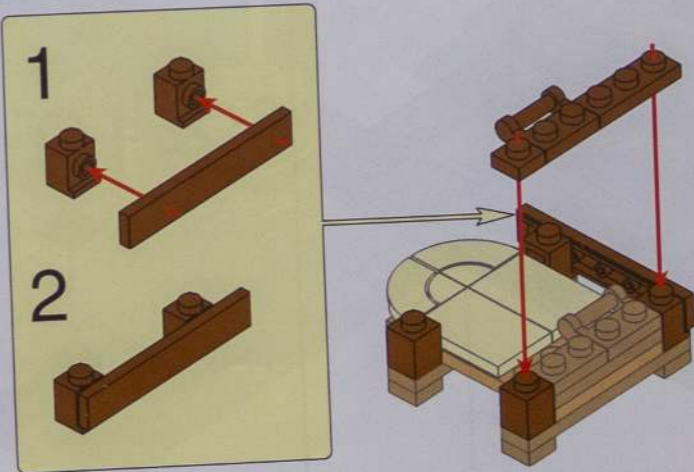

2-7

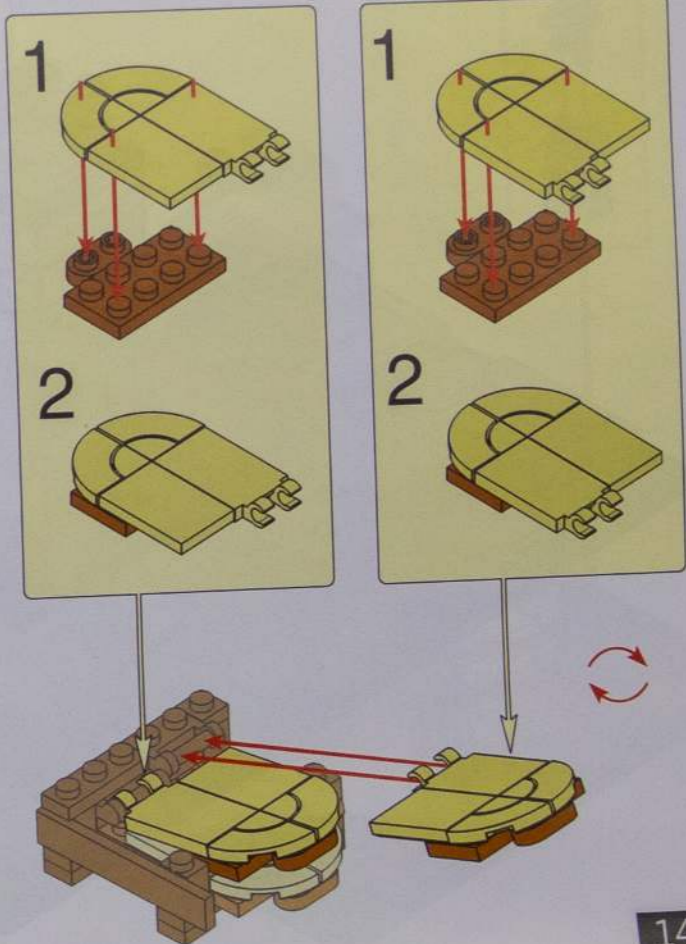

2-8

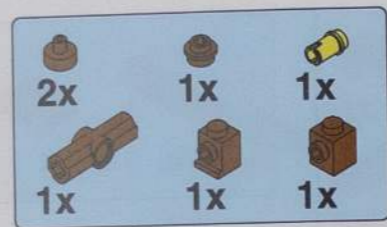

2-9

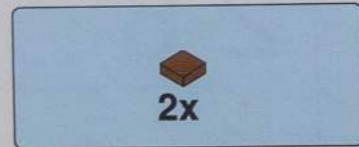
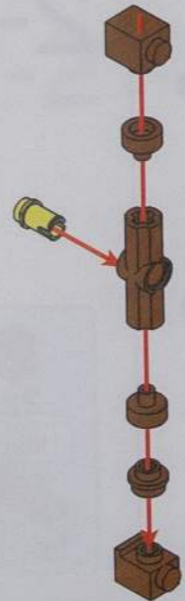

2-10

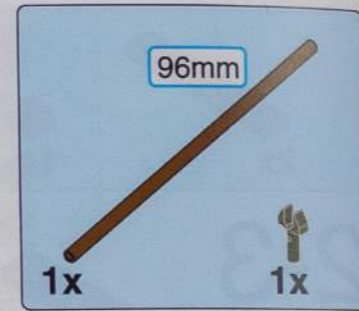
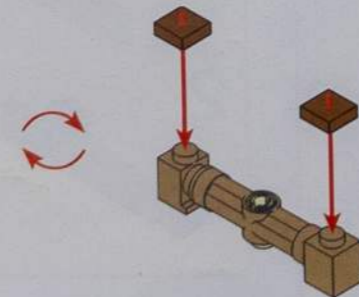

2-11

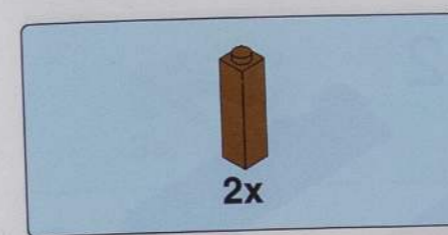
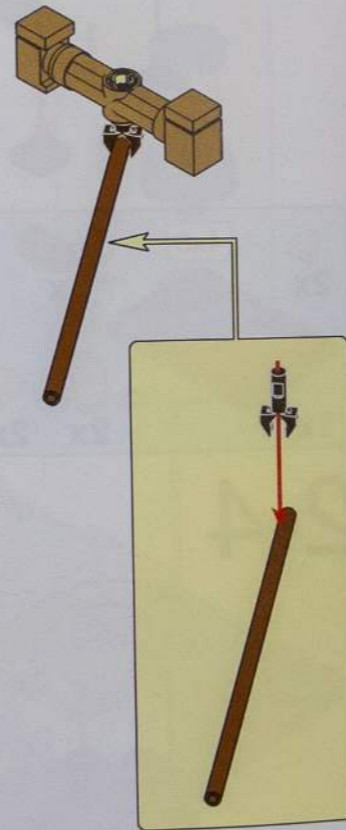

2-12

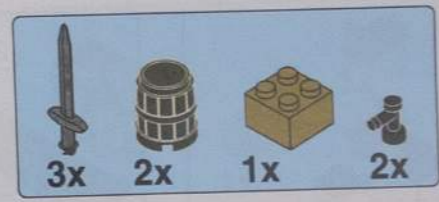
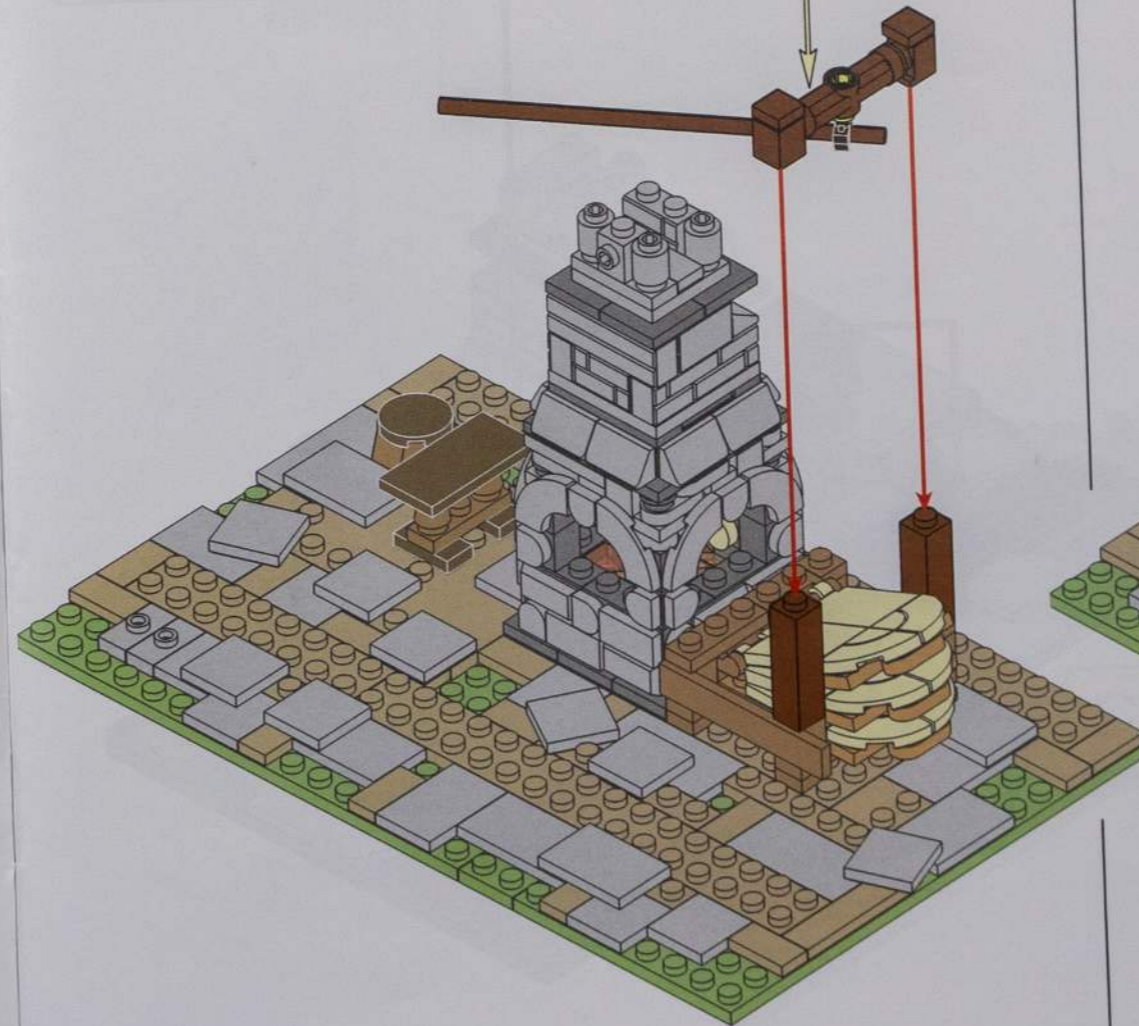

2-13

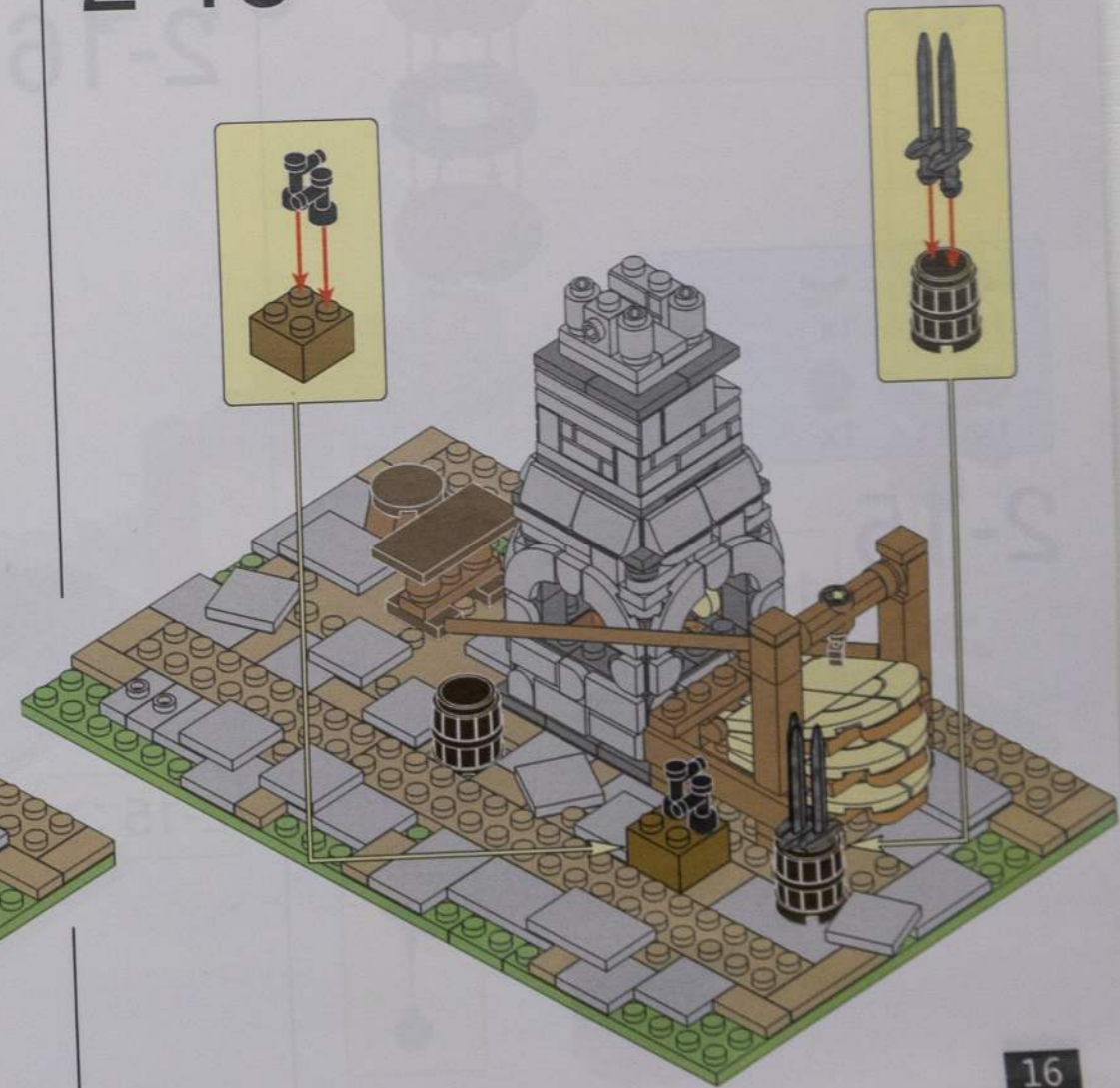

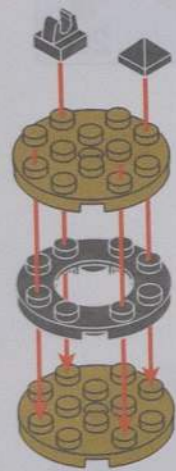
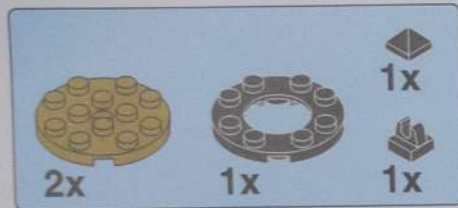

2-14

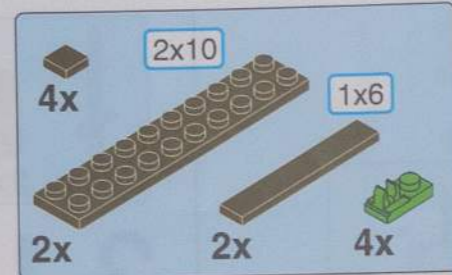

2-16

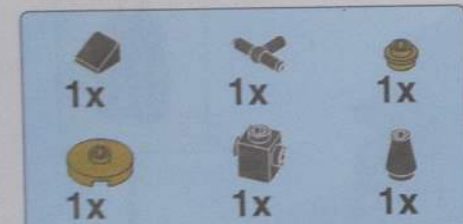
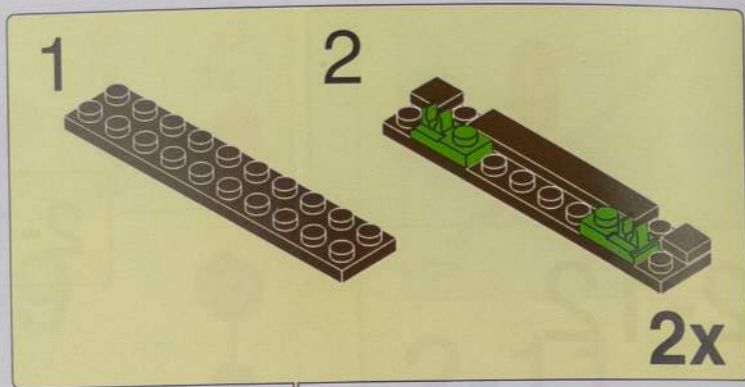

2-15

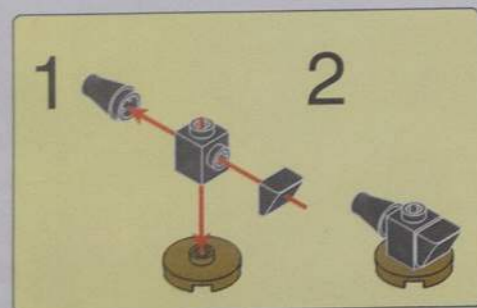

2-15



2-17

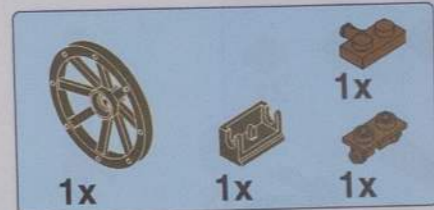

2-18

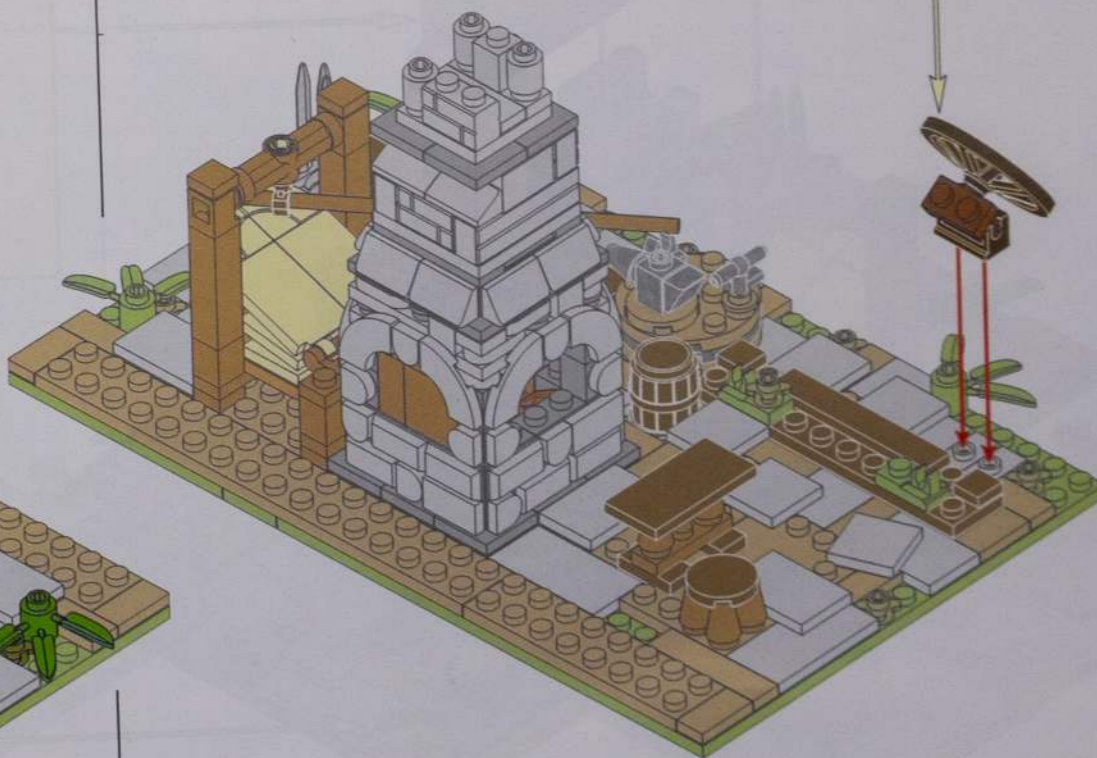
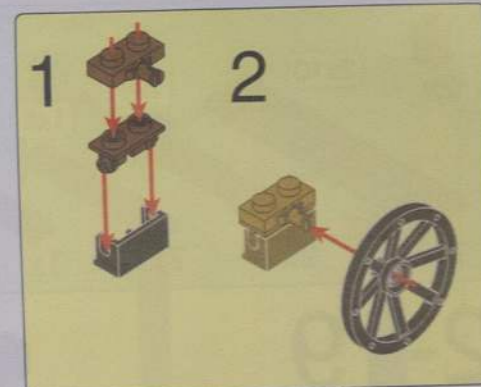

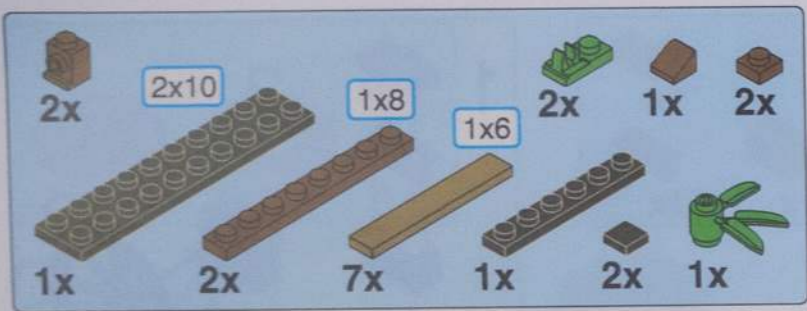

2-19

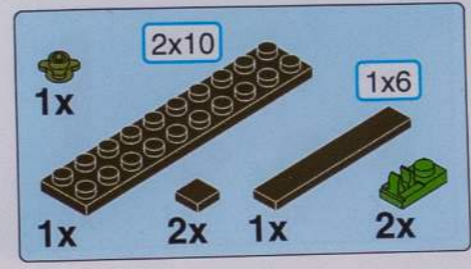
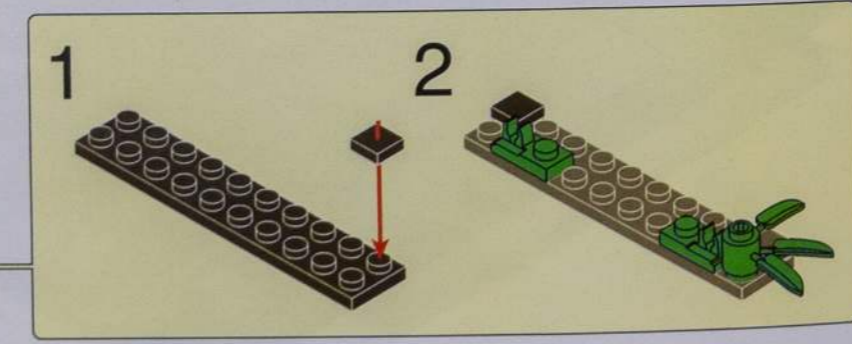
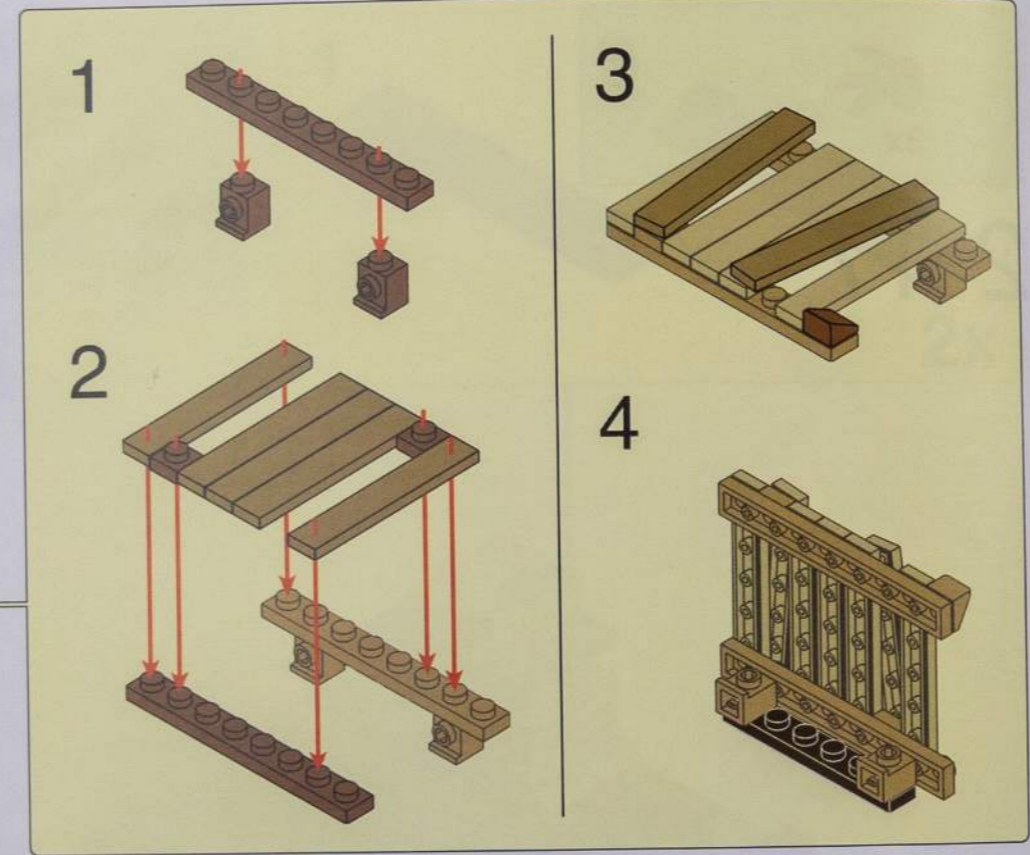
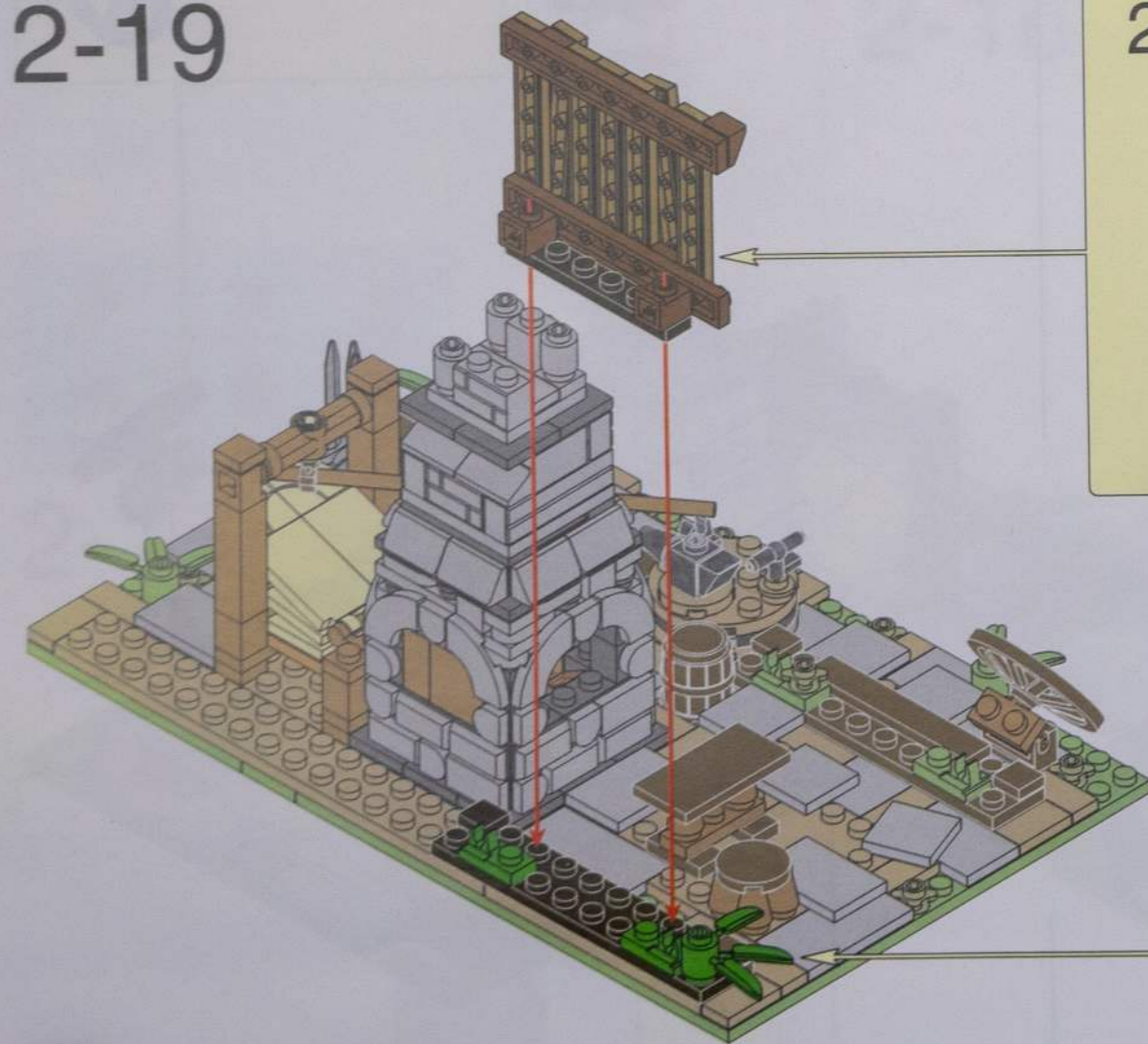

2-20

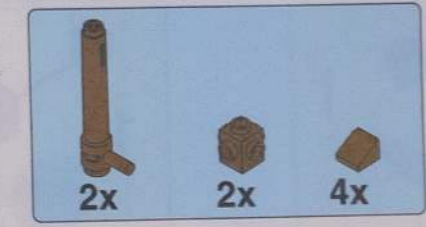
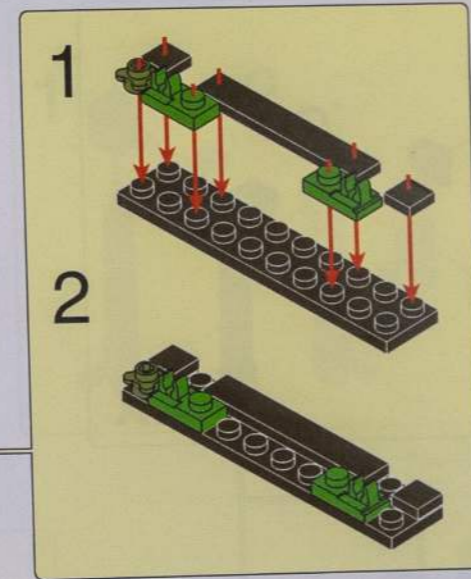
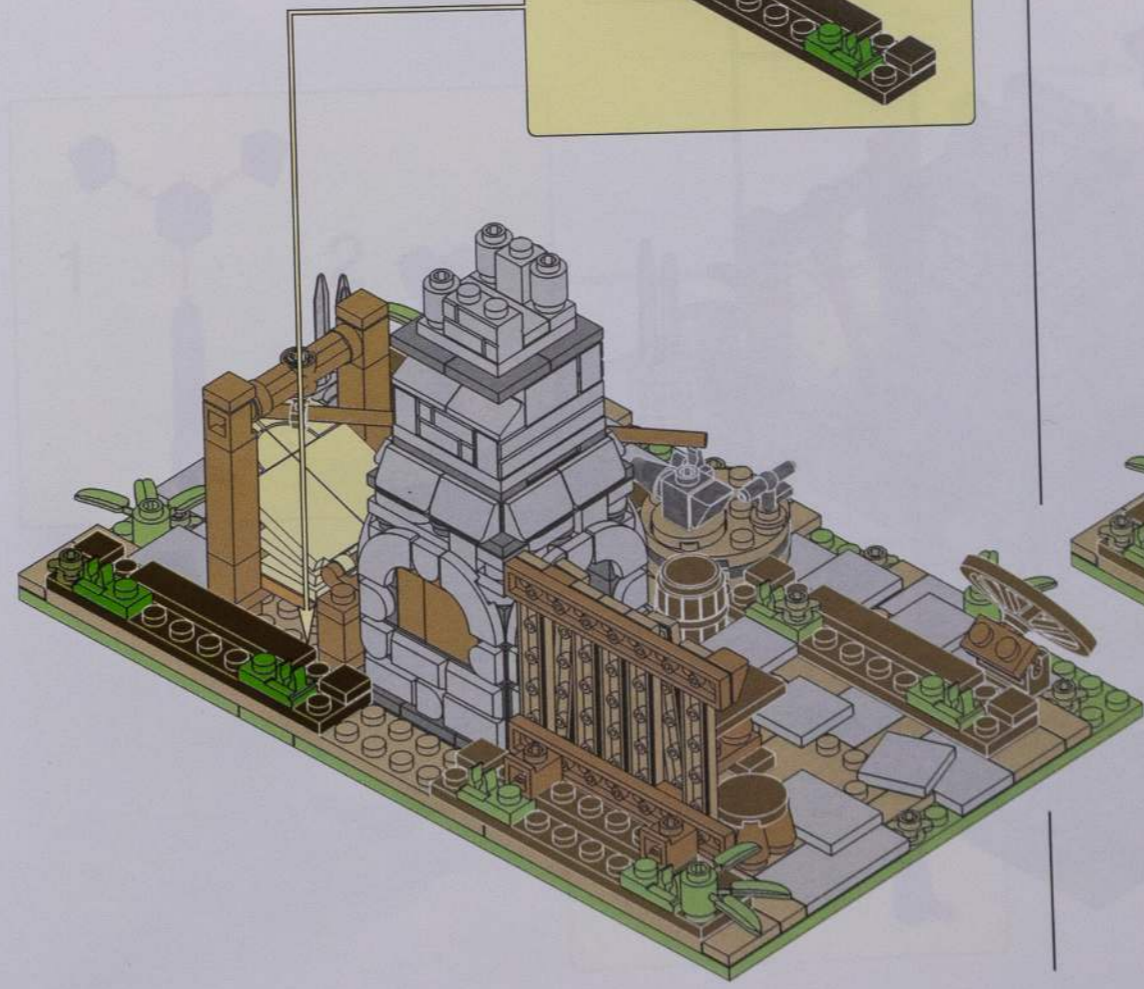

2-21

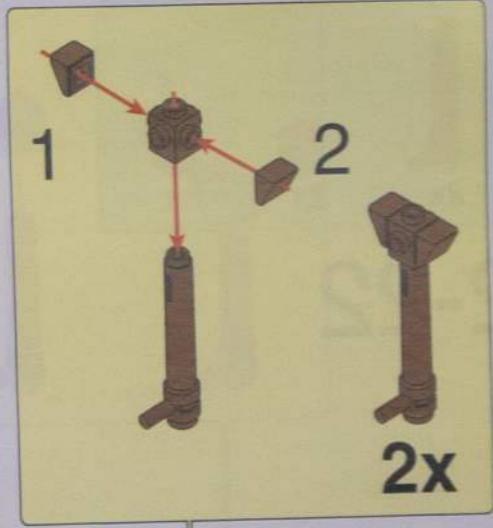
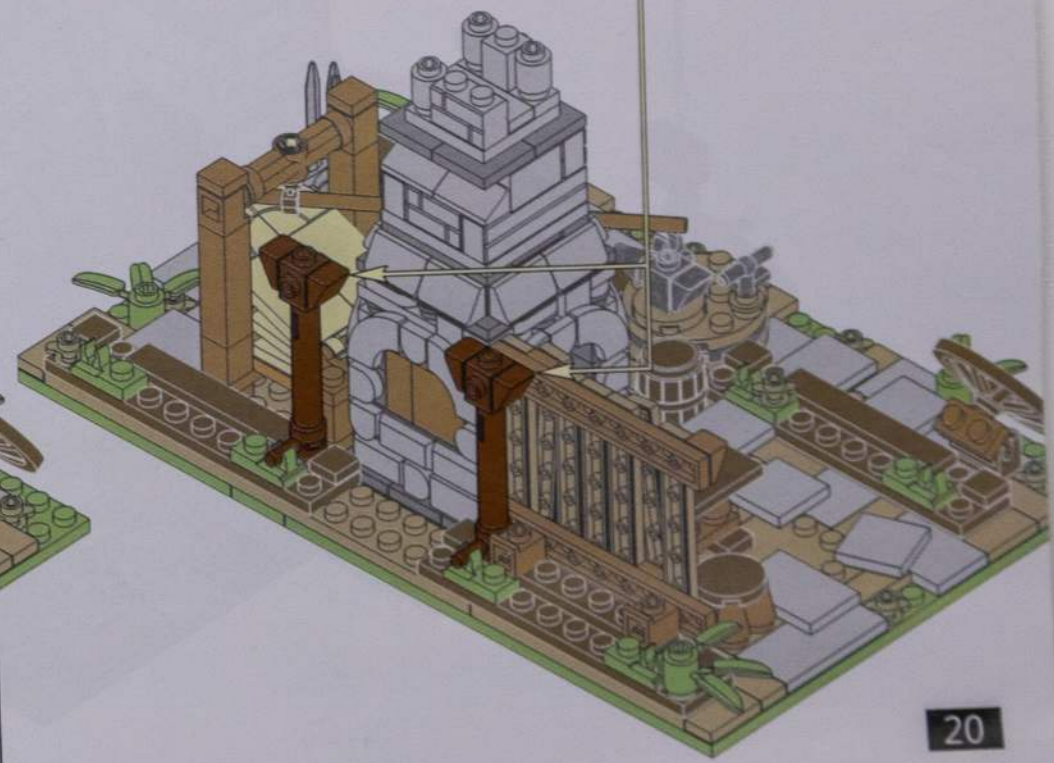

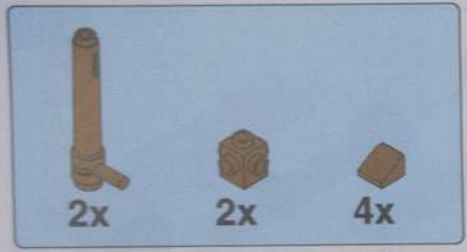

2-22

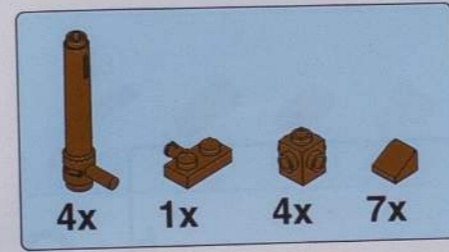
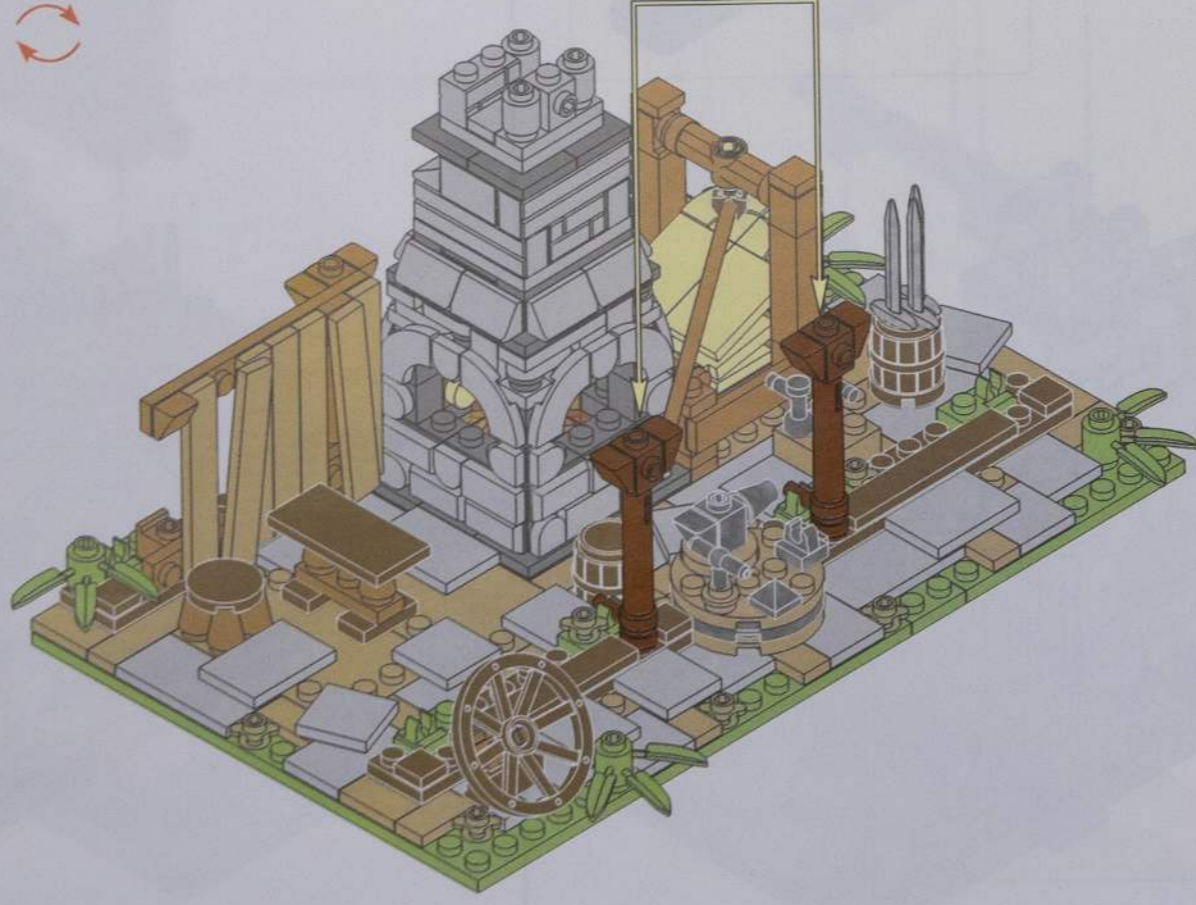
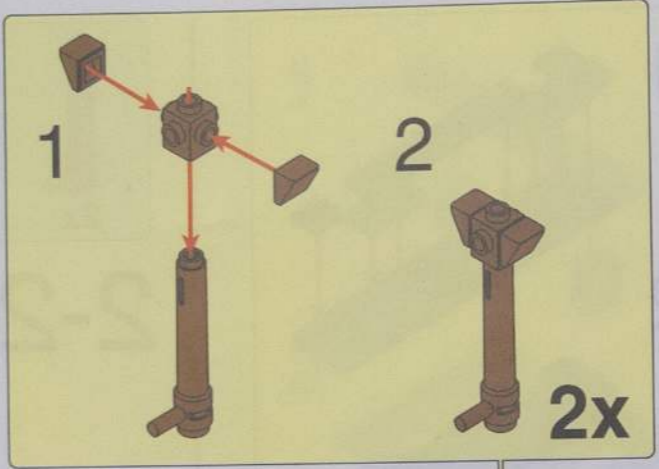

2-23

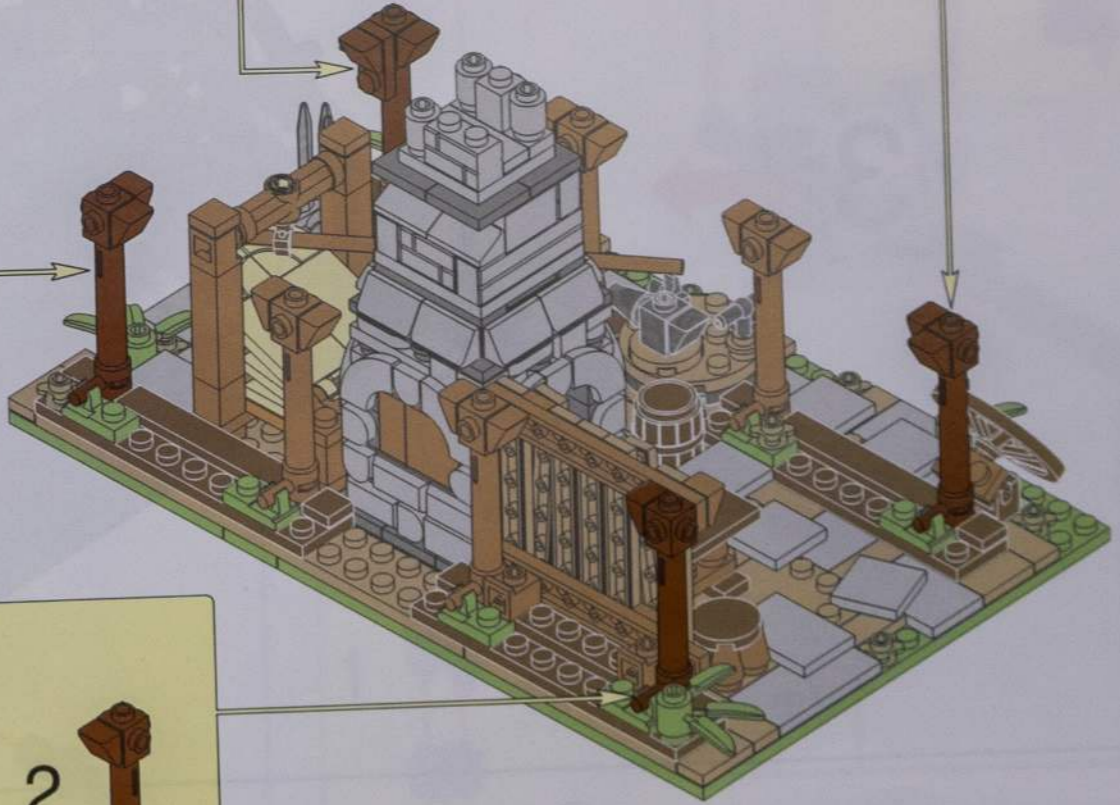
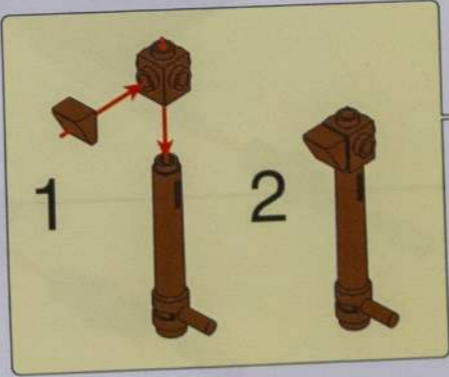
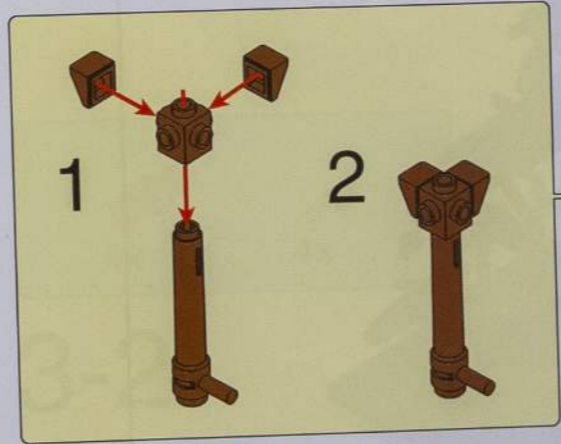
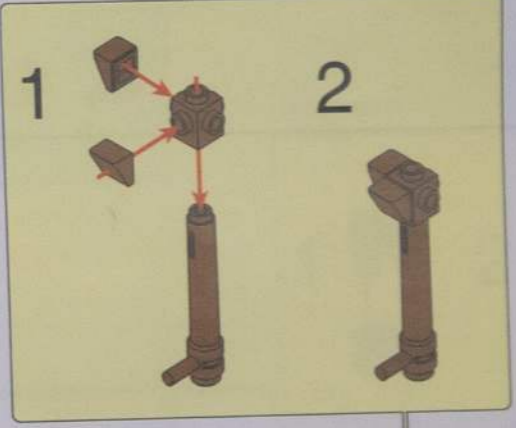
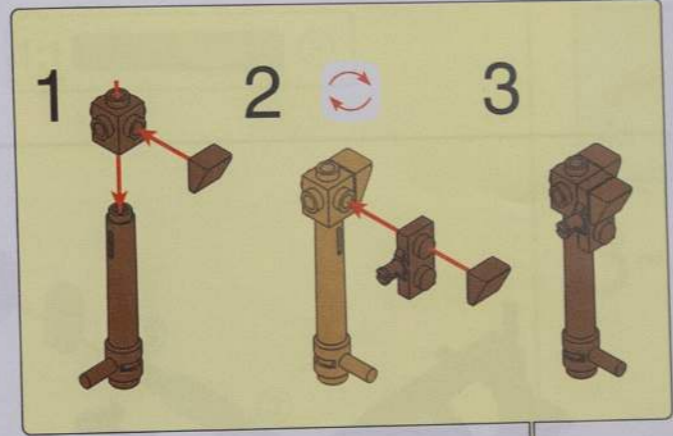

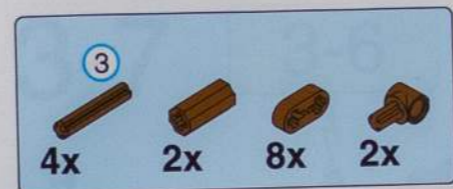
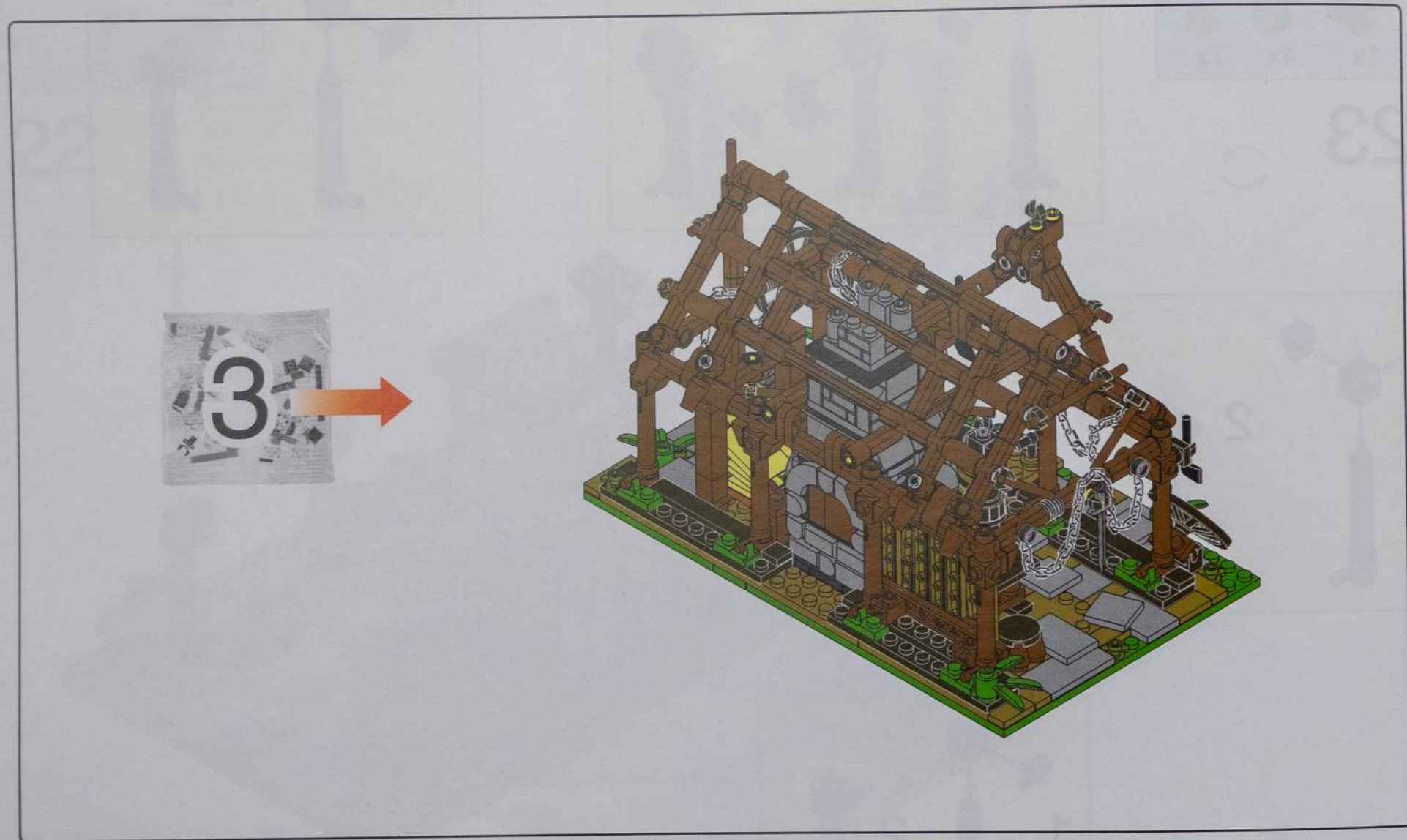

3-1

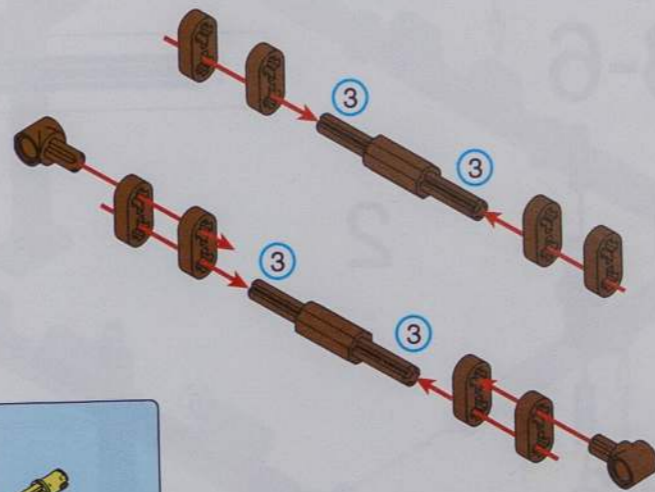

3-2

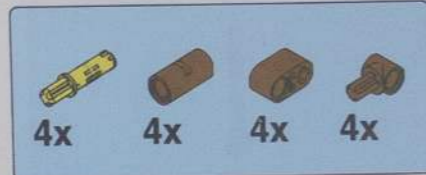
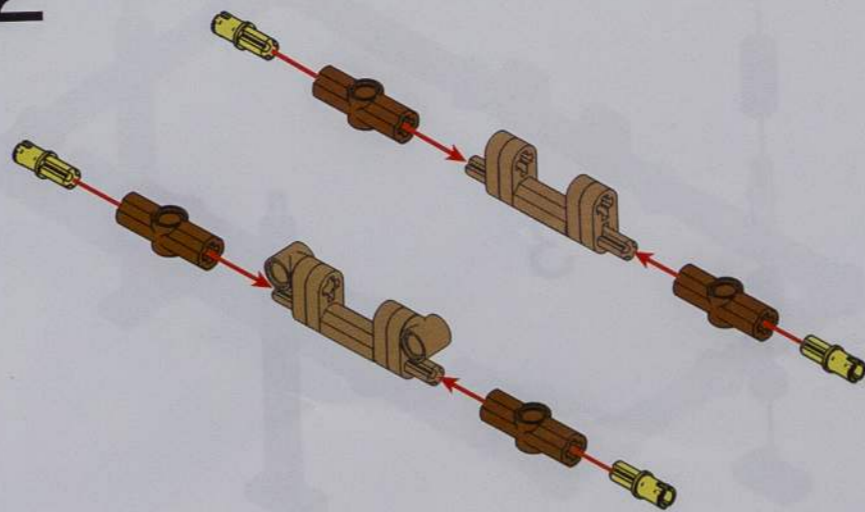

3-3

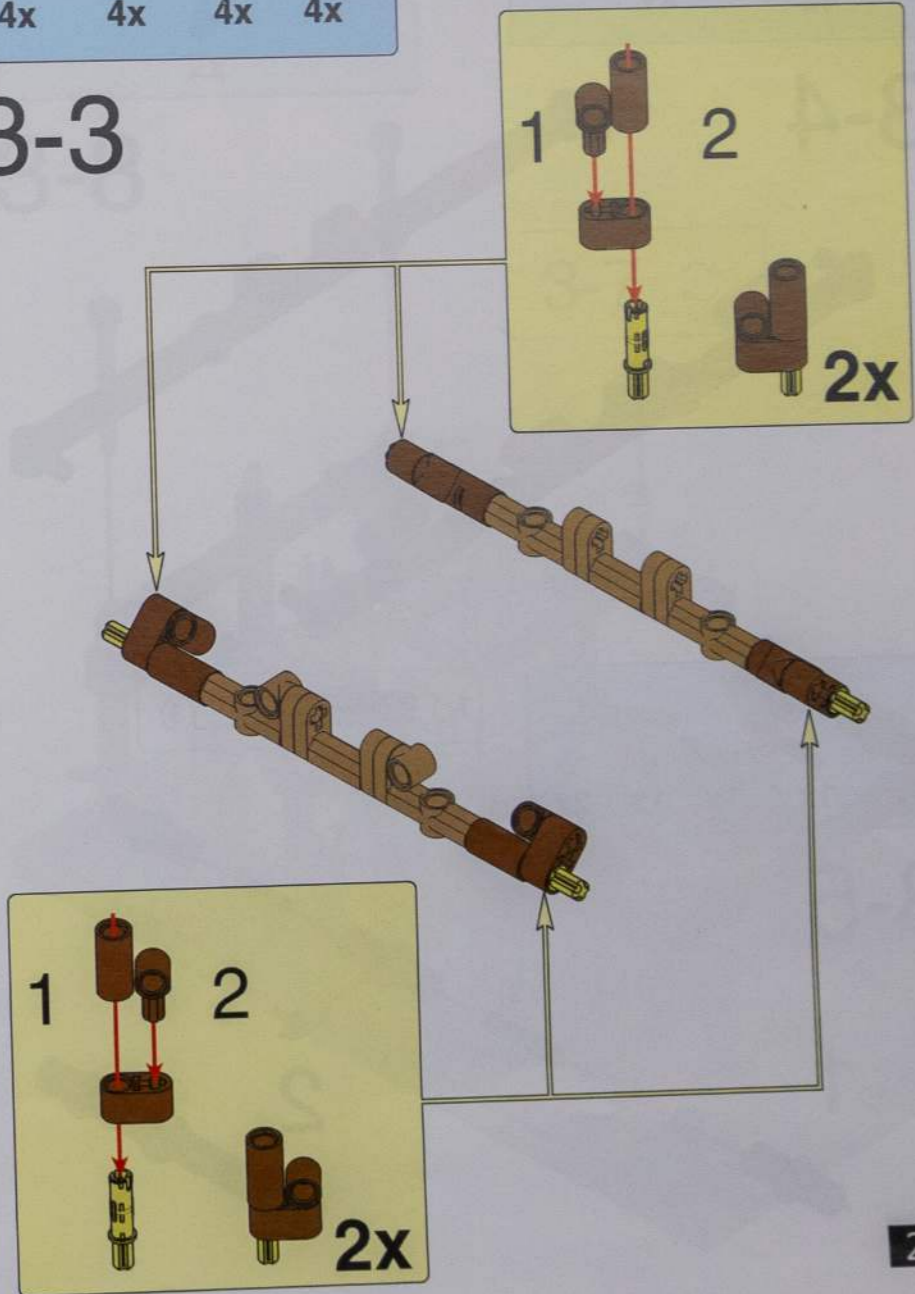

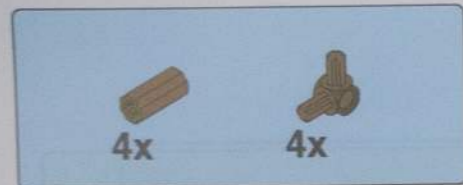

3-4

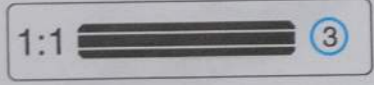
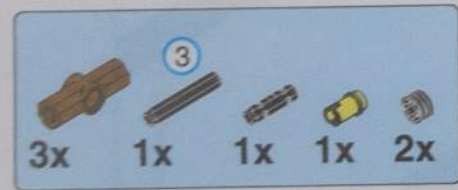

3-5

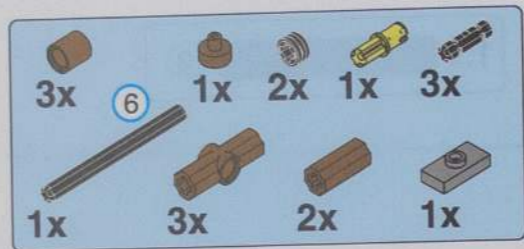
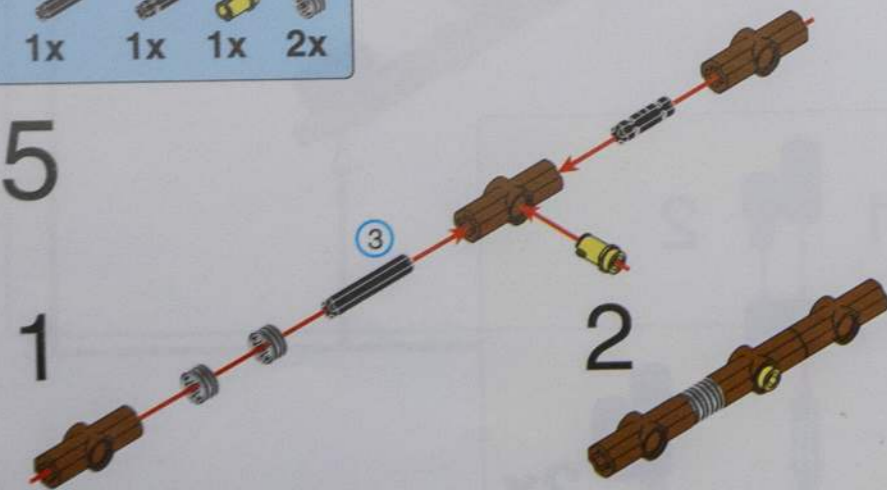

3-6

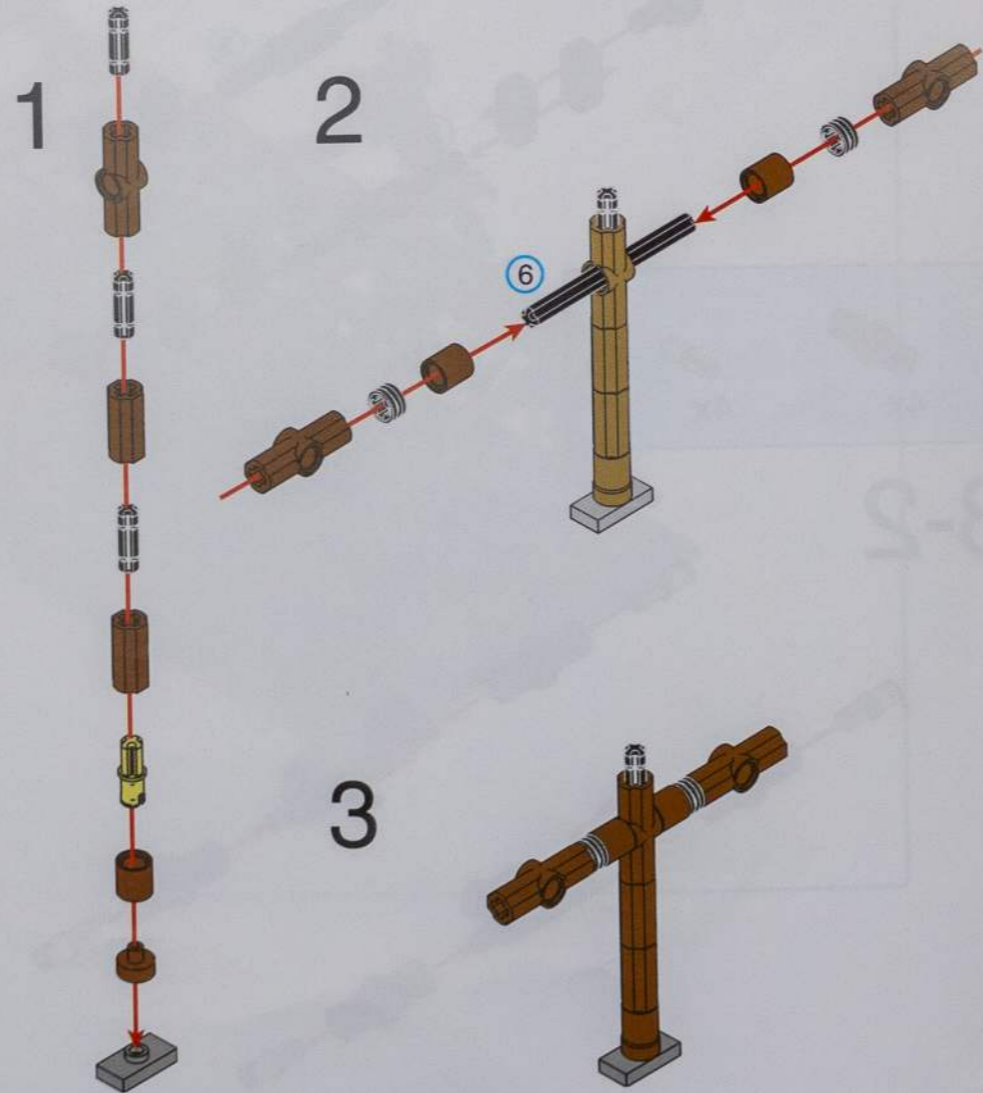
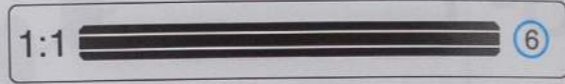

3-7

3-6

3-4

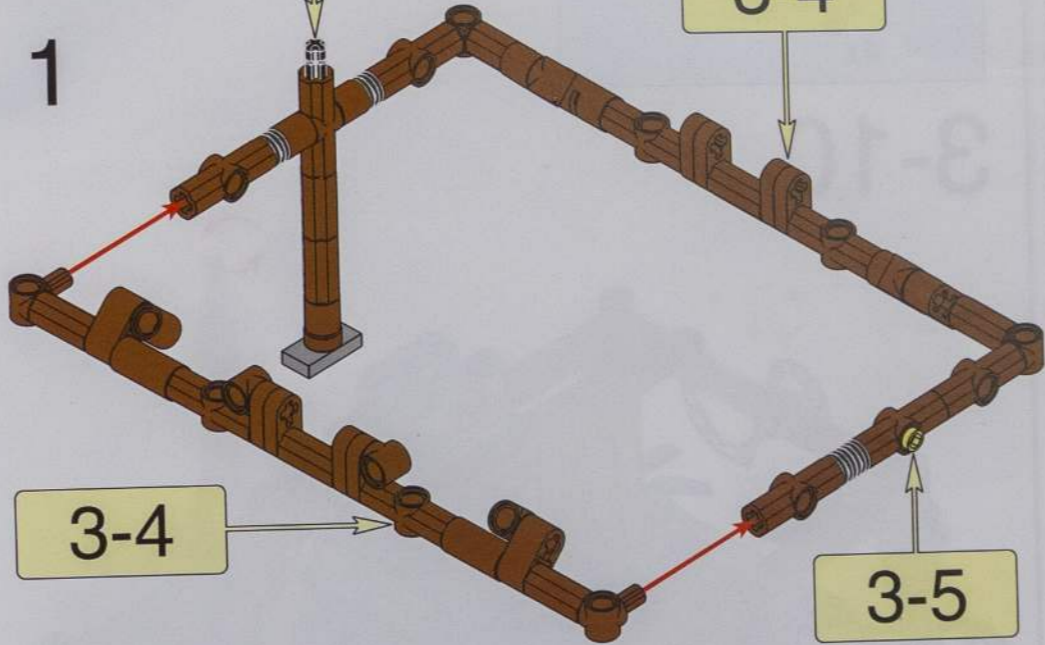

2

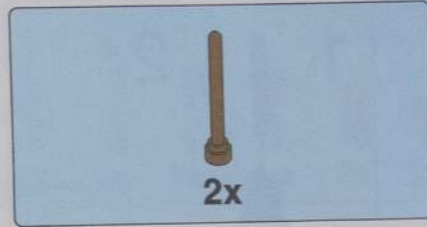
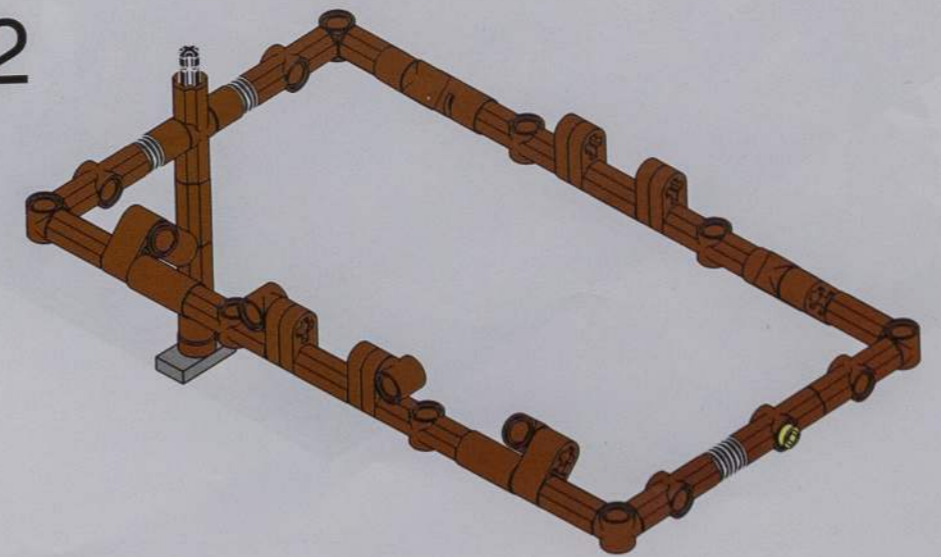

3-8

3-7

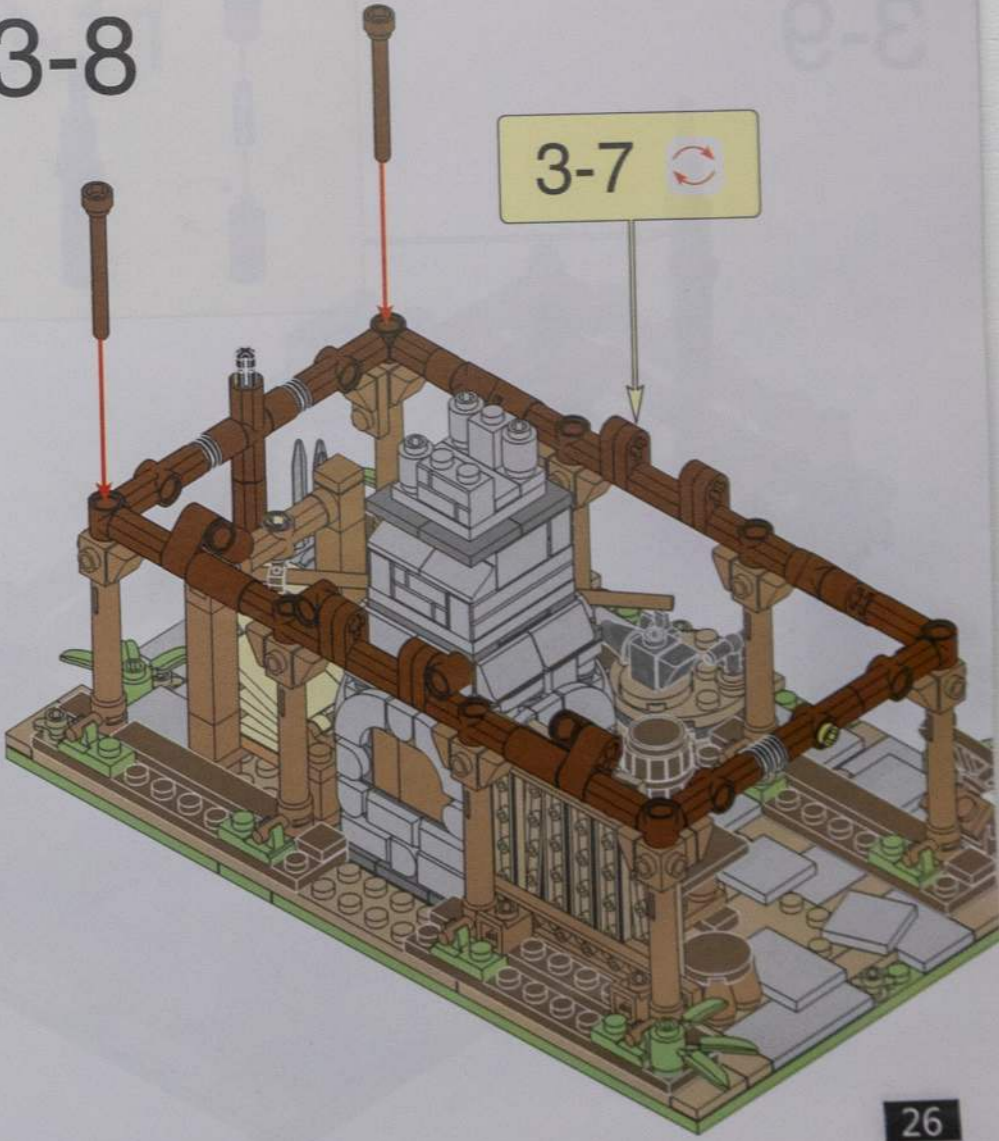

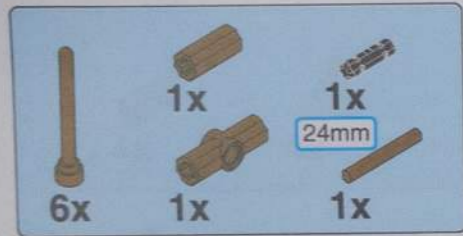

3-9

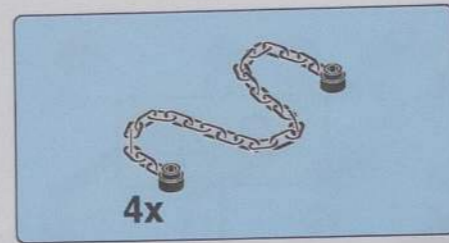
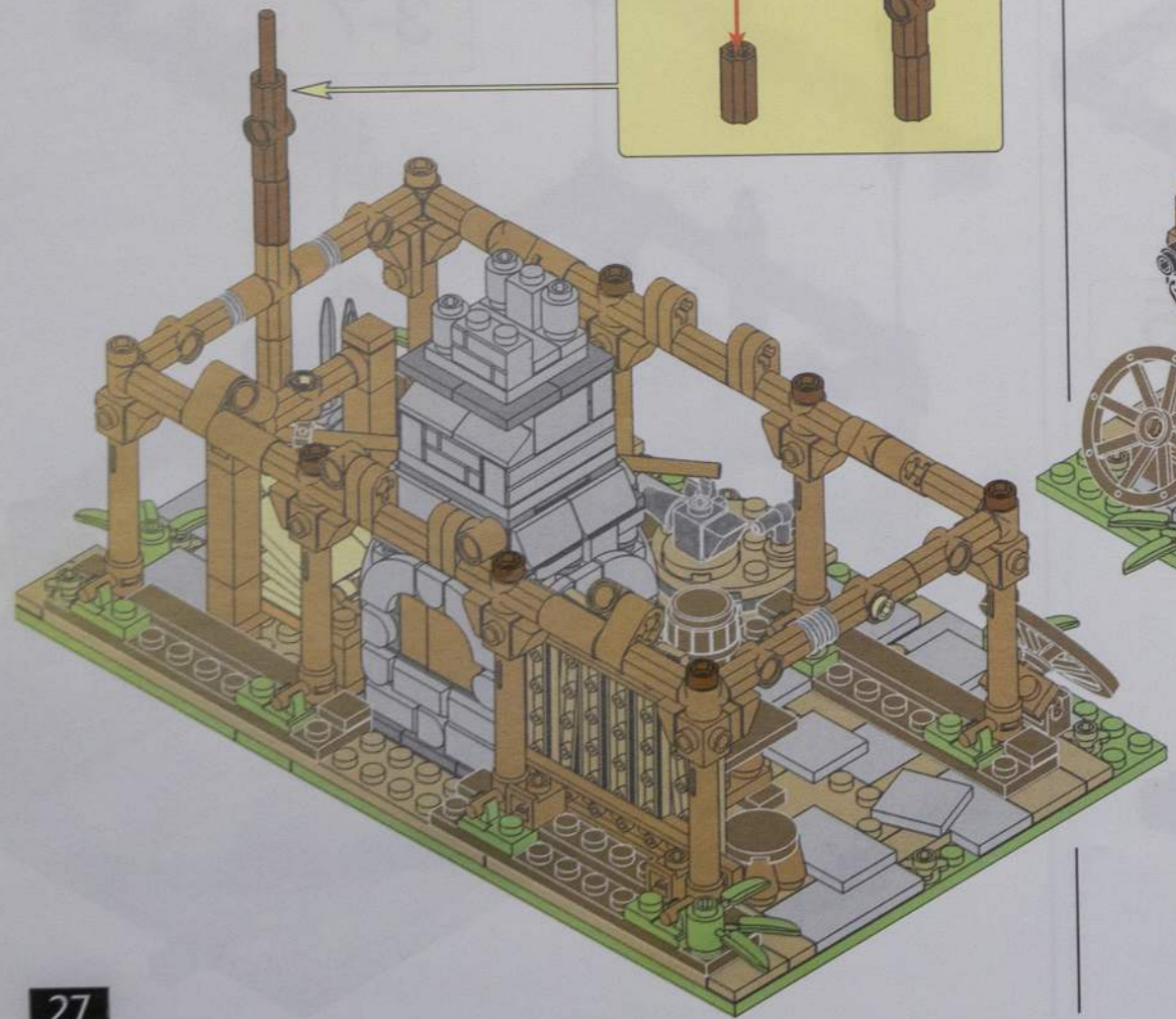
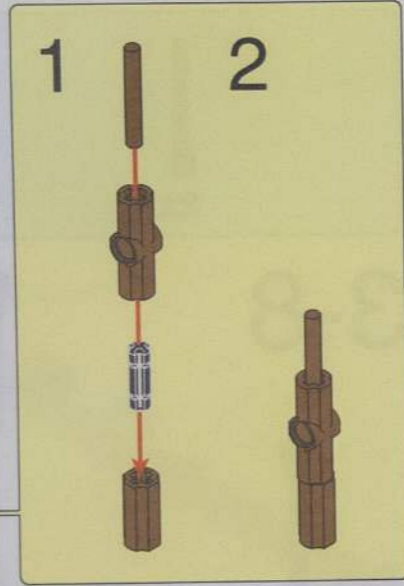

3-10

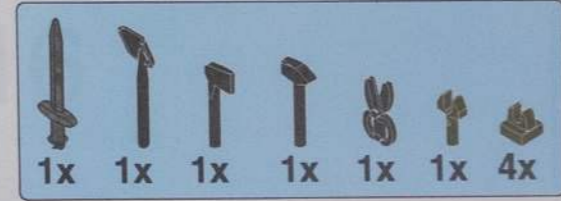
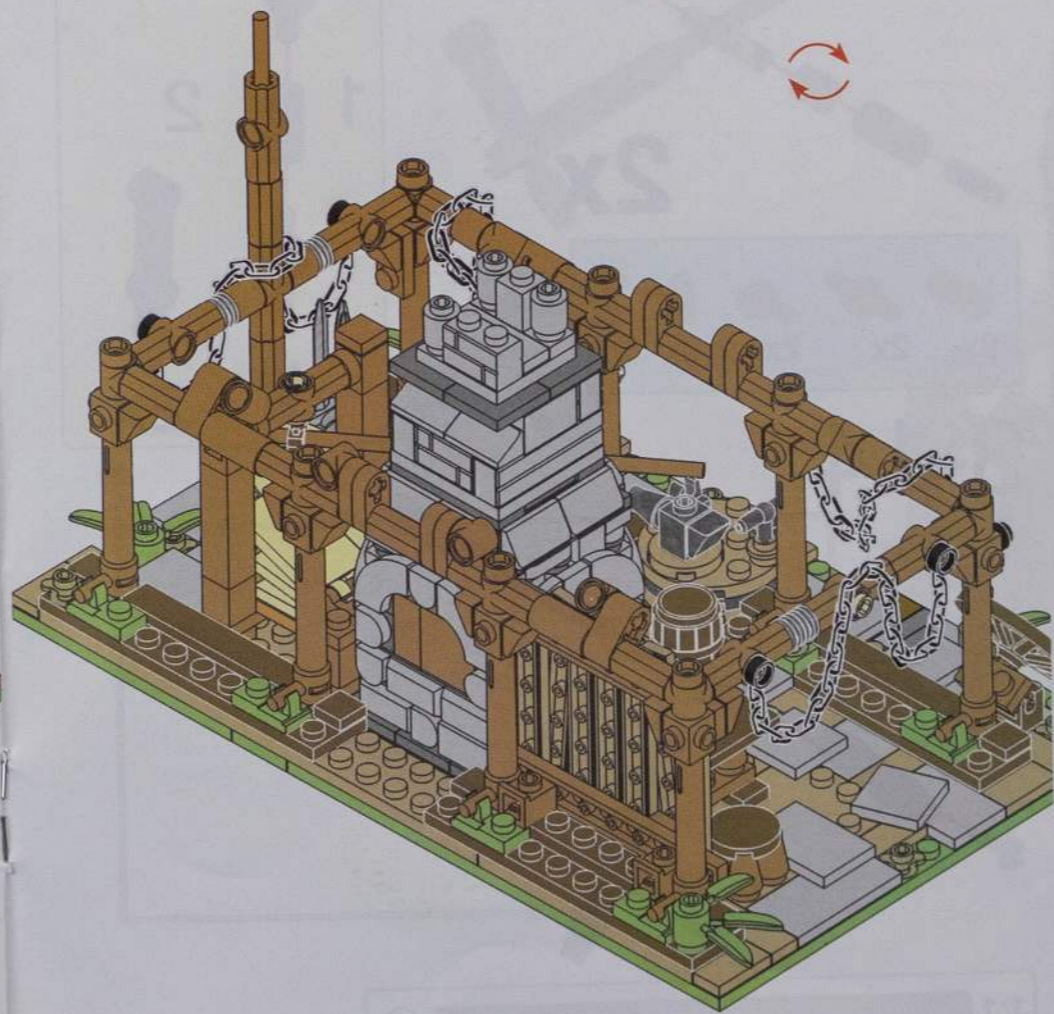
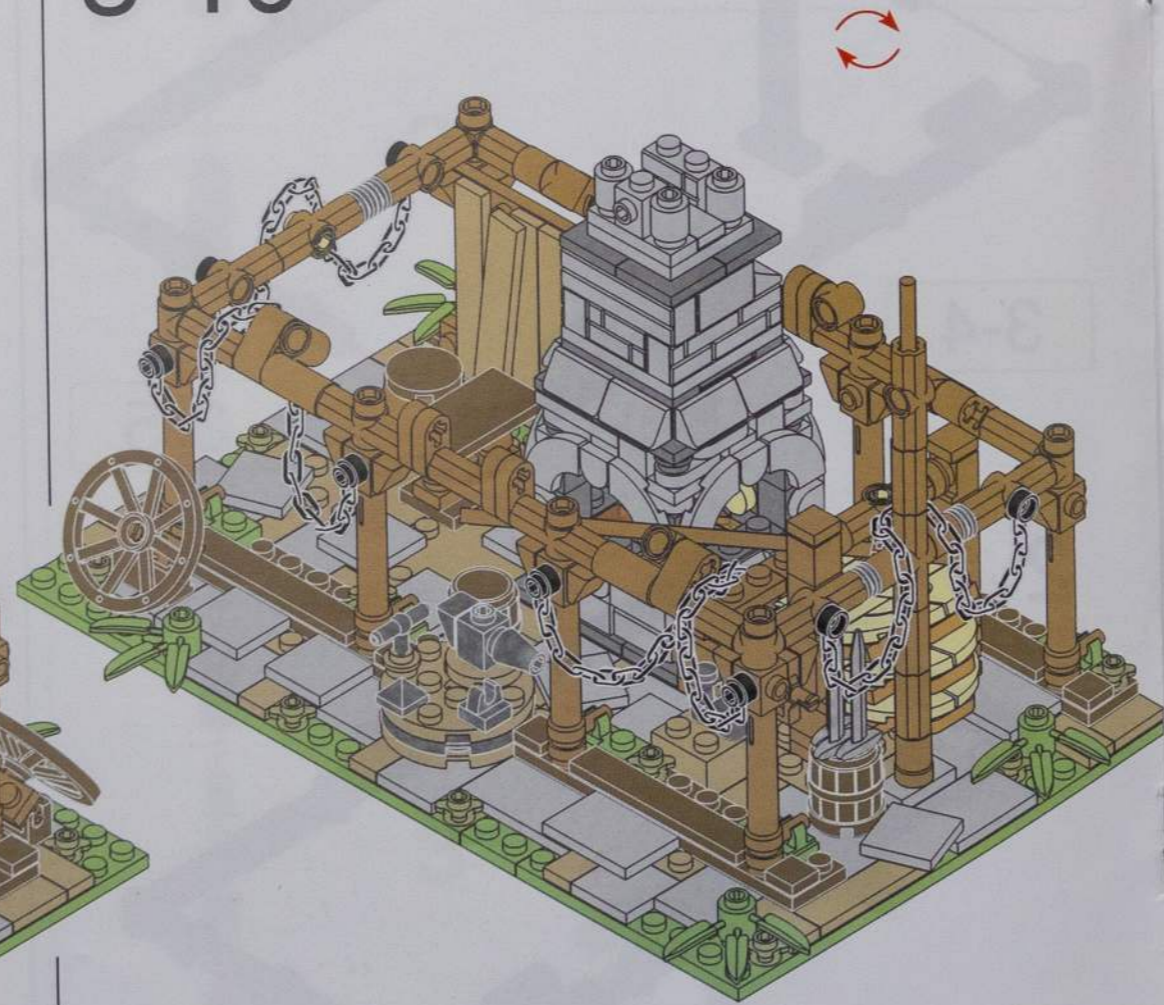

3-11

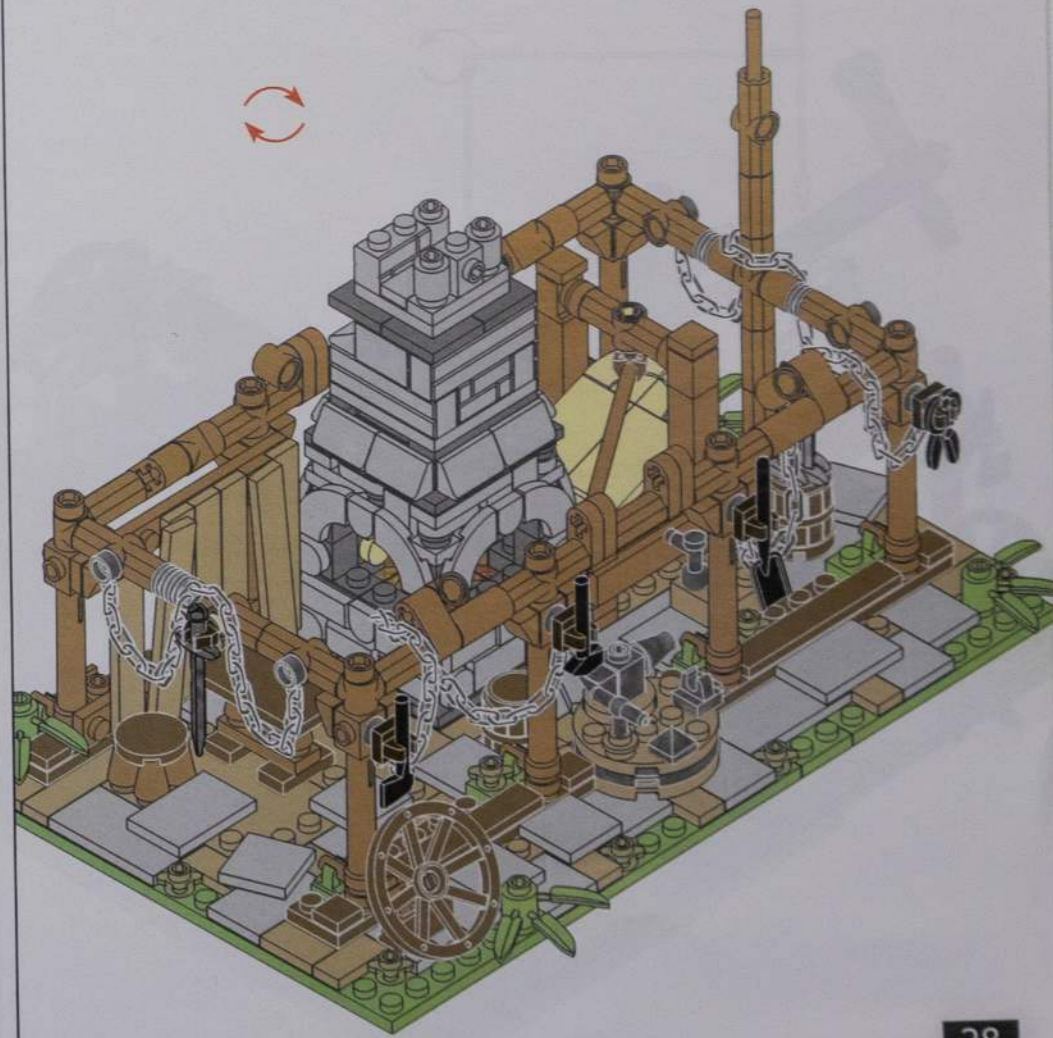

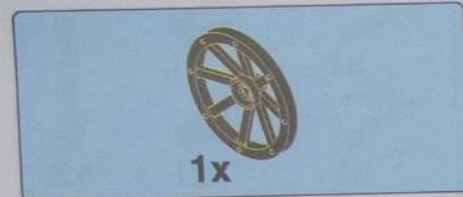

3-12

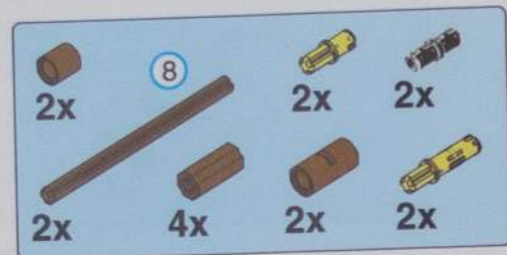
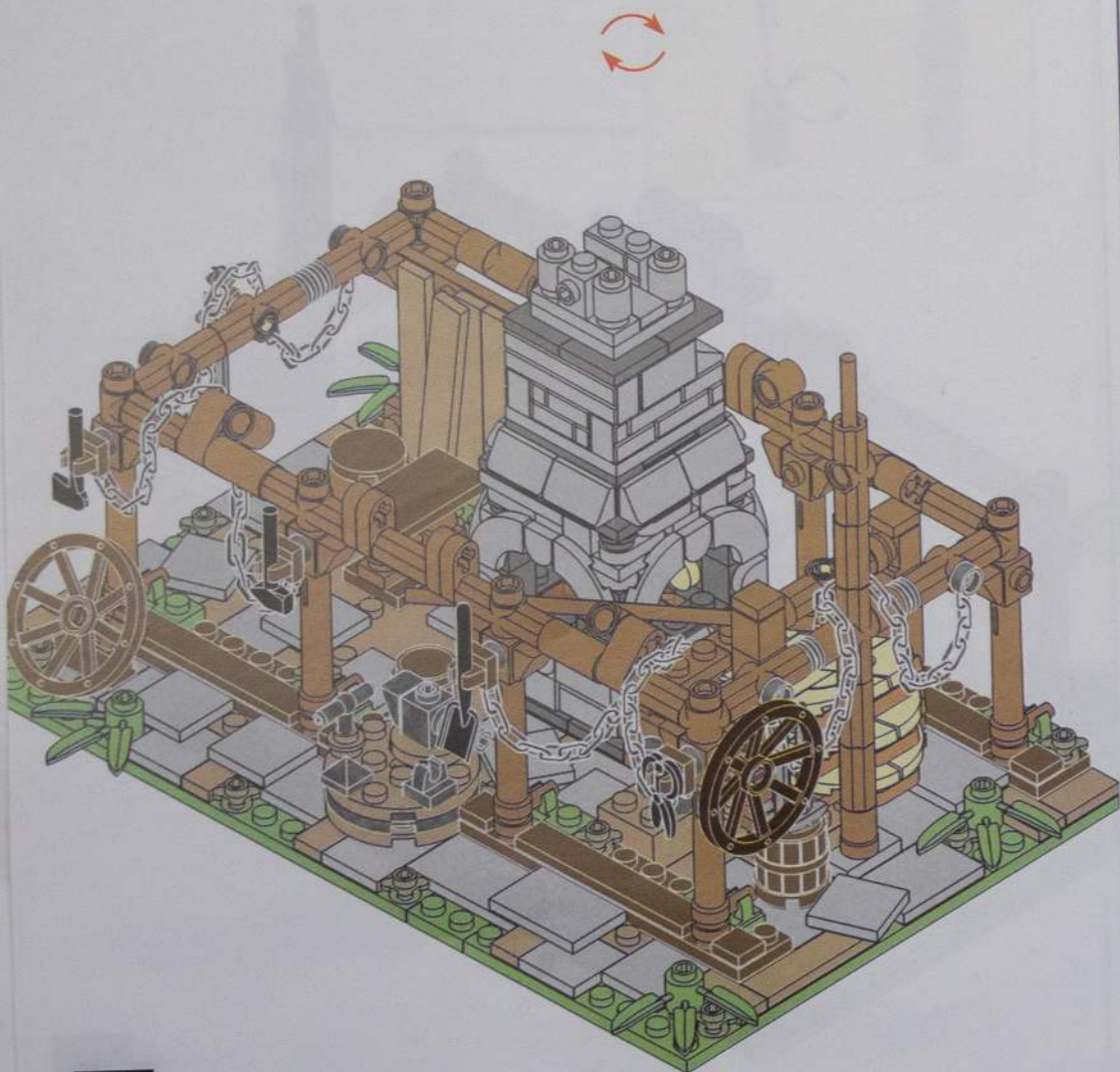

3-13

2x

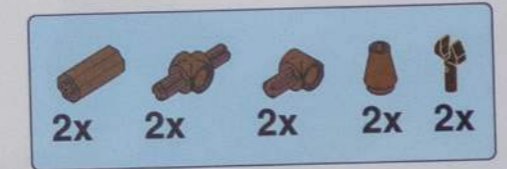

3-14

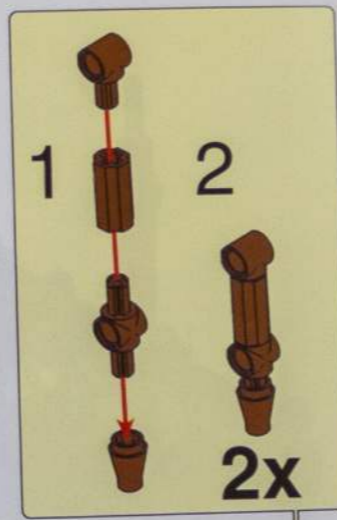
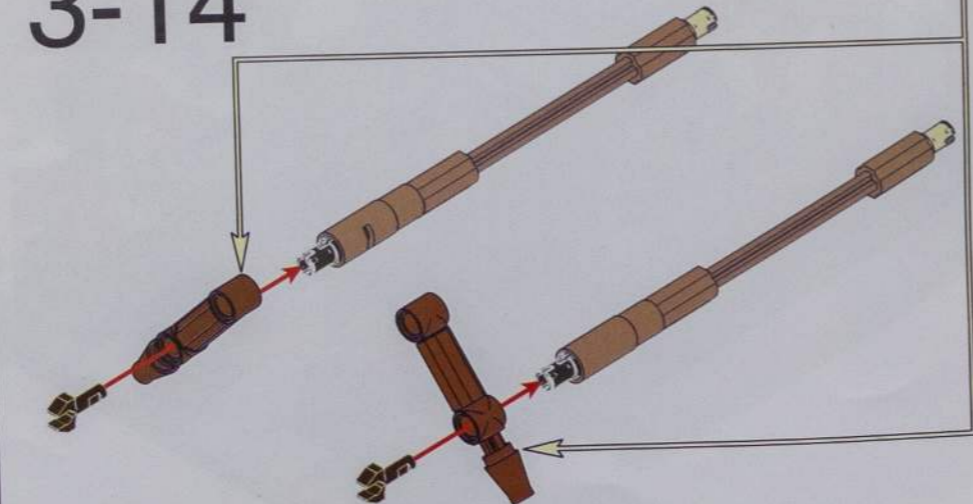

3-15

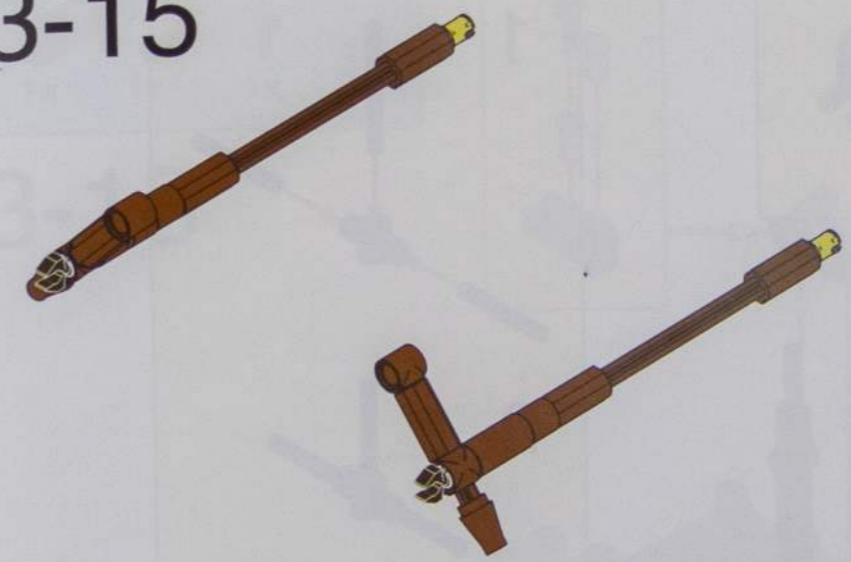

3-16

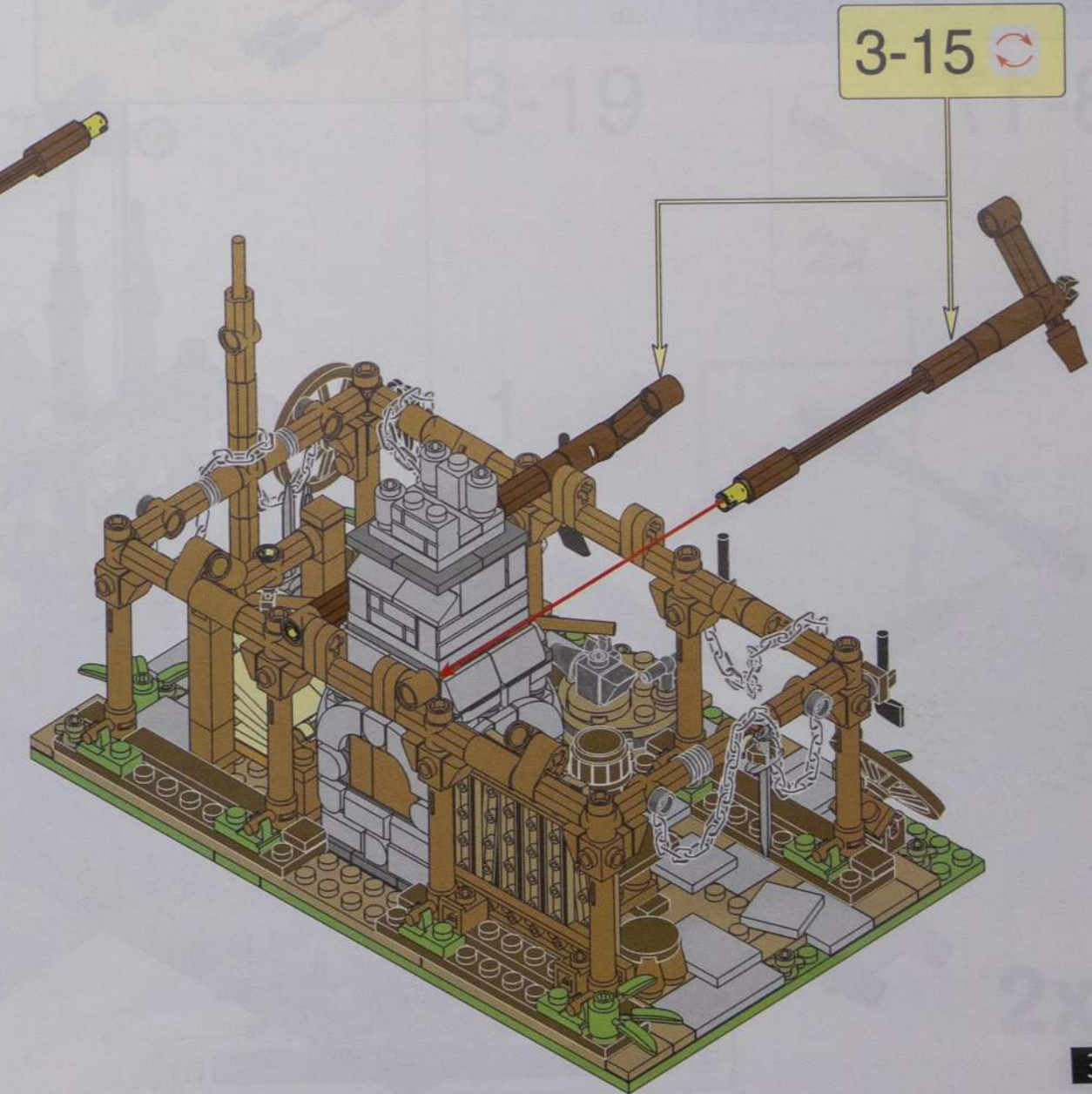



3-17

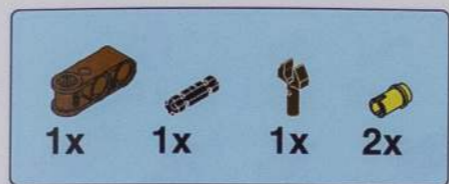
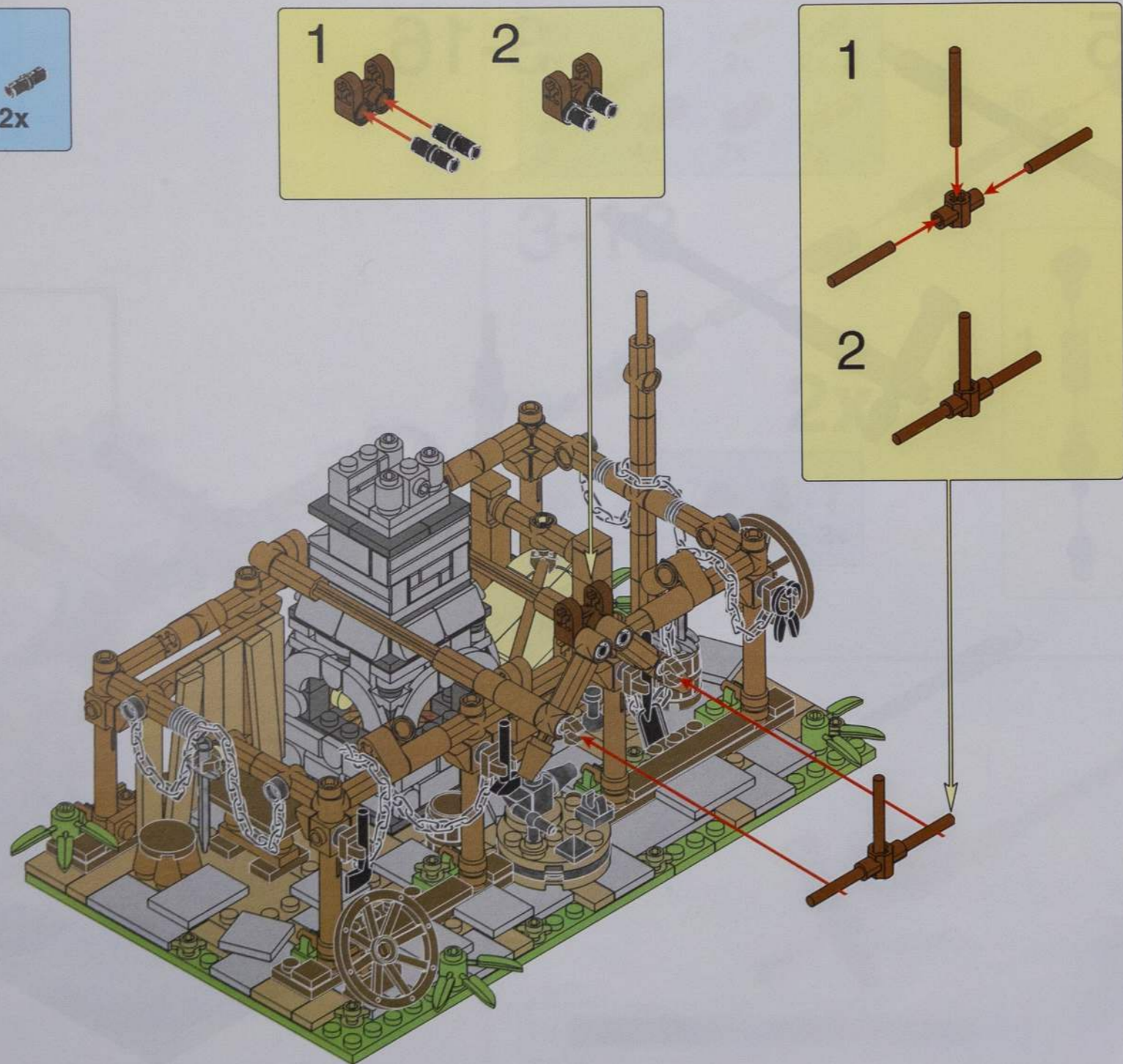

3-18

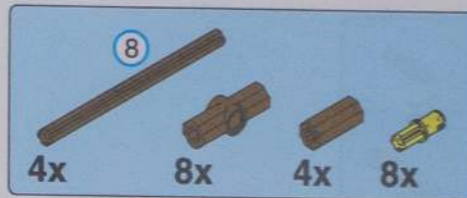
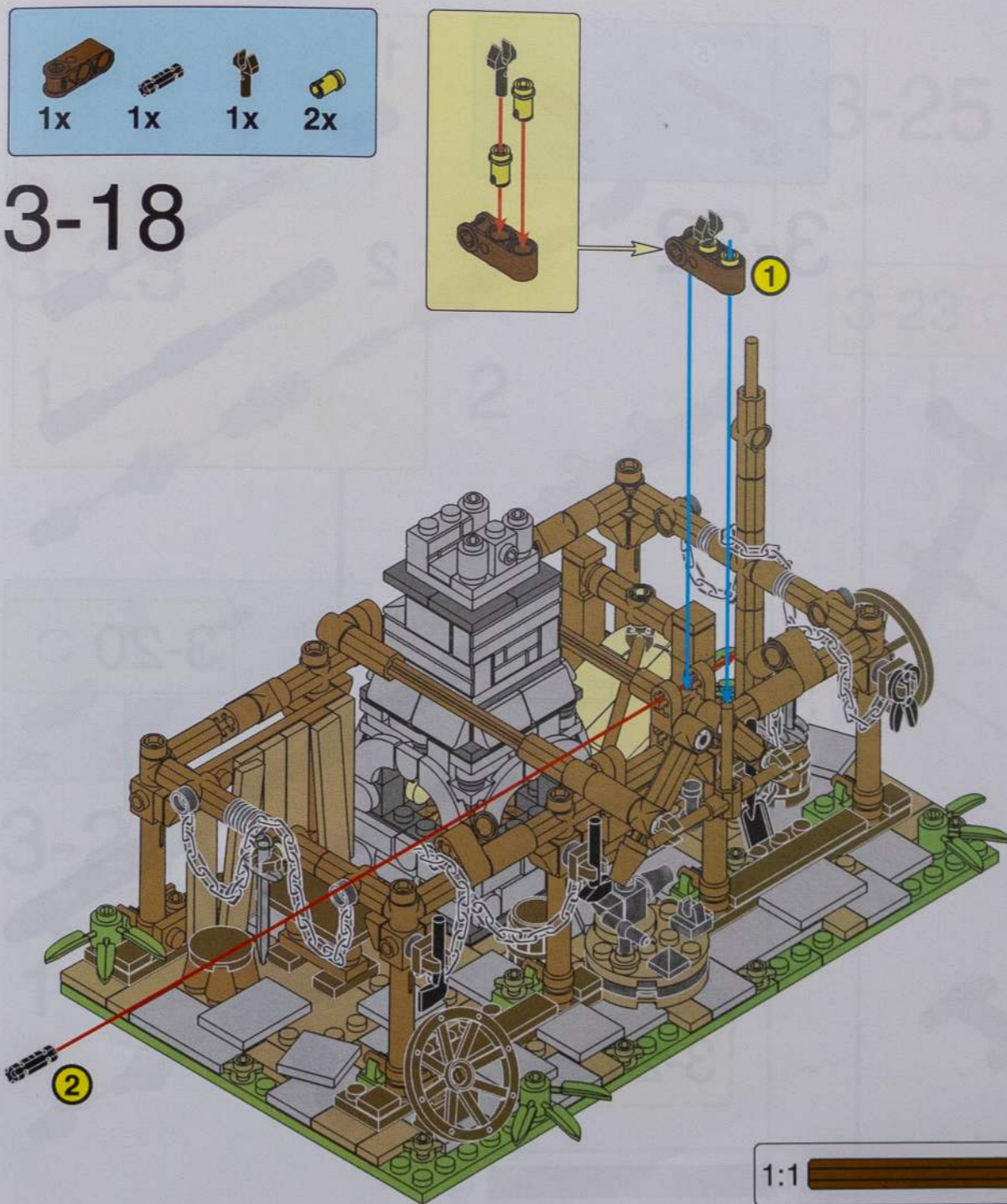

3-19

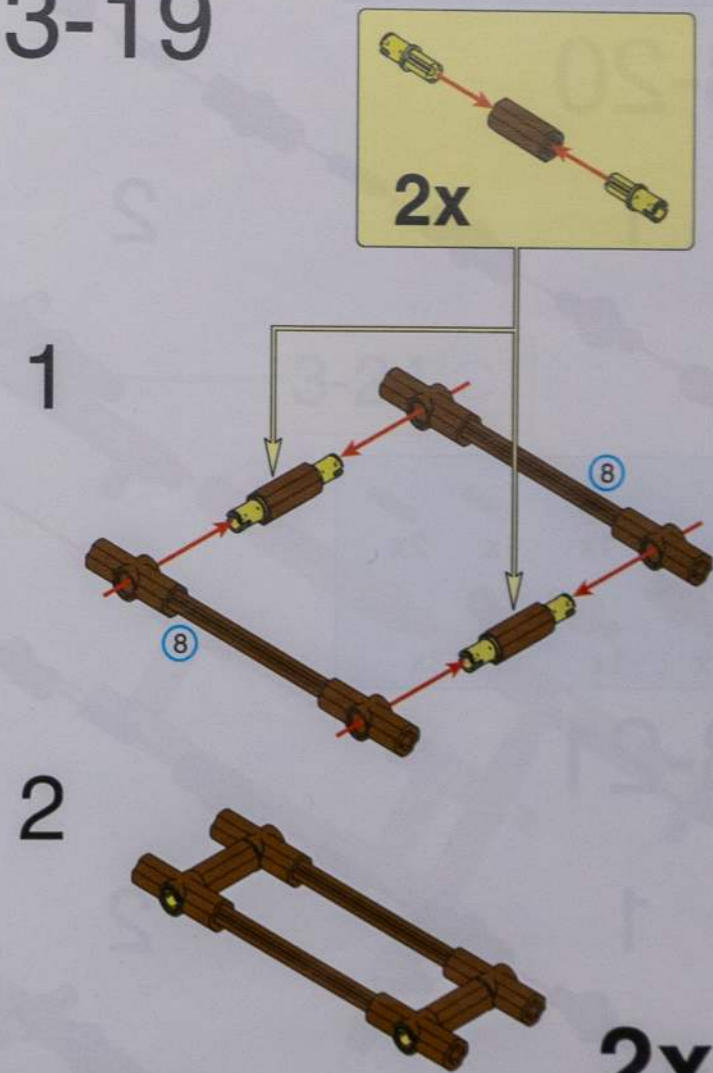

2x

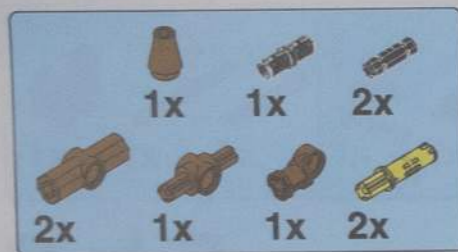

3-20

1

2

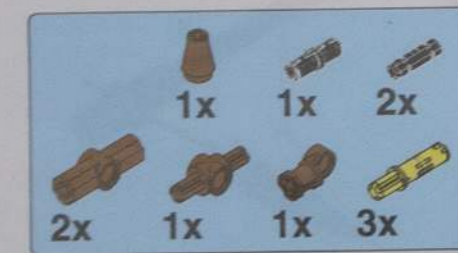
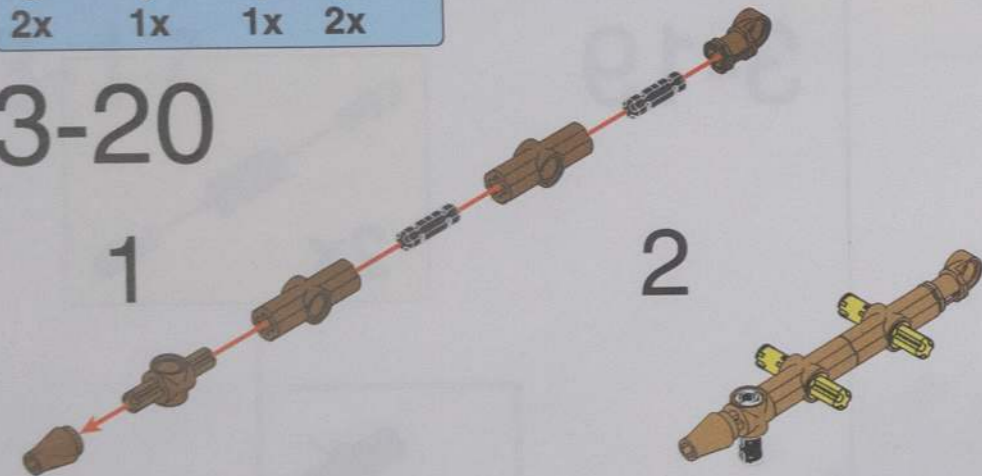

3-21

1

2

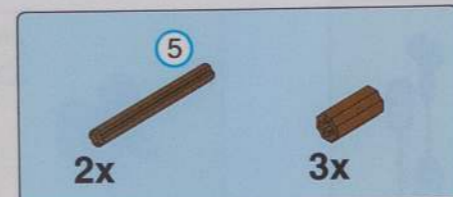
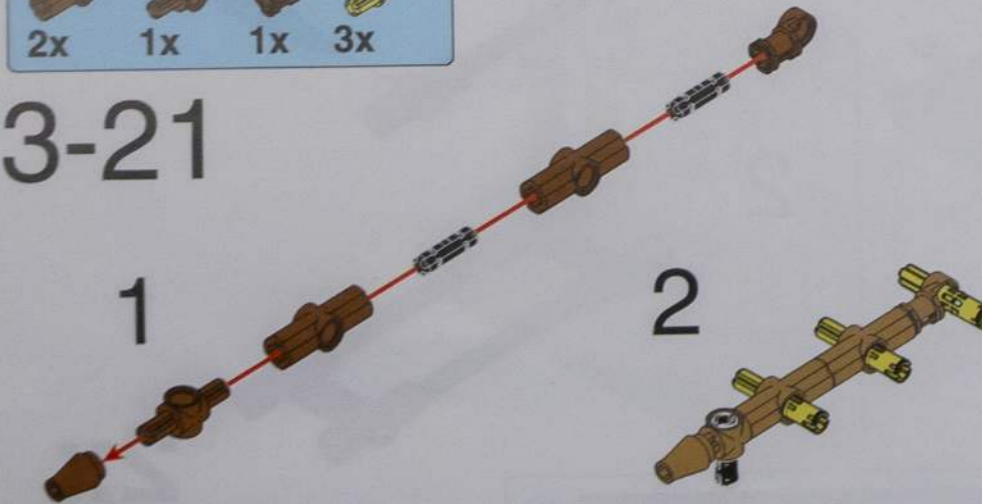

3-22

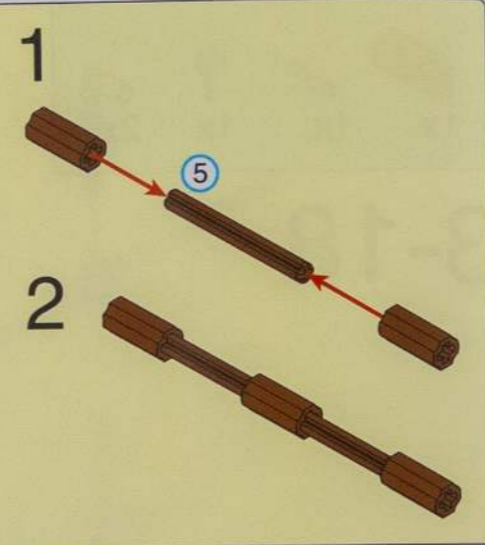

3-19

3-20

3-21

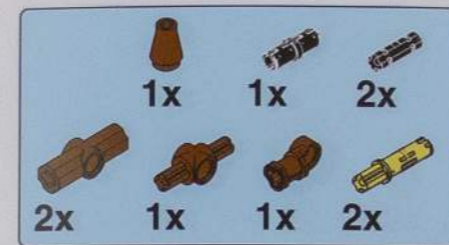

3-23

1

2

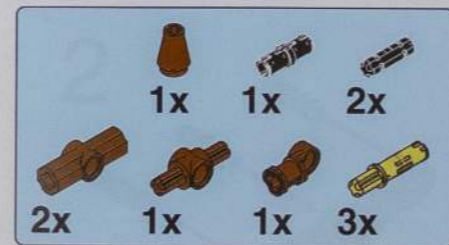
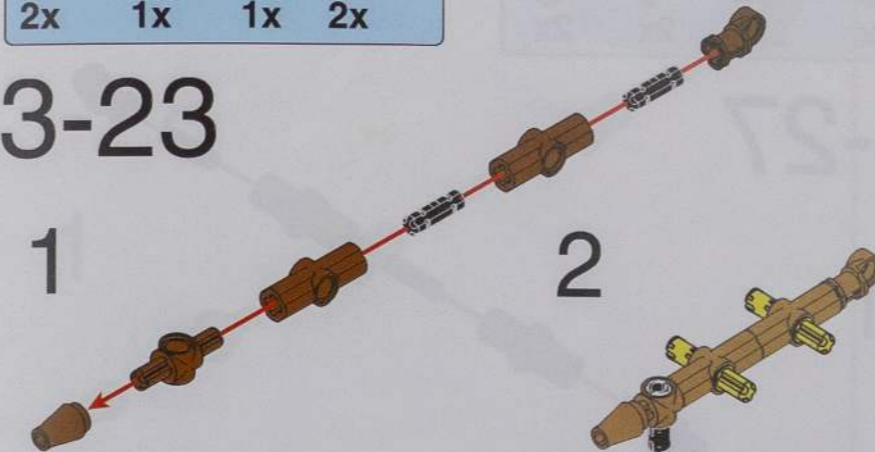

3-24

1

2

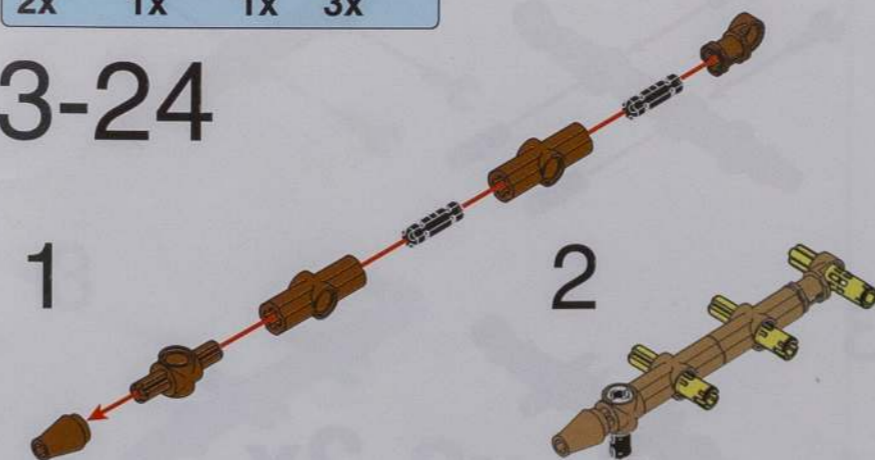

3-25

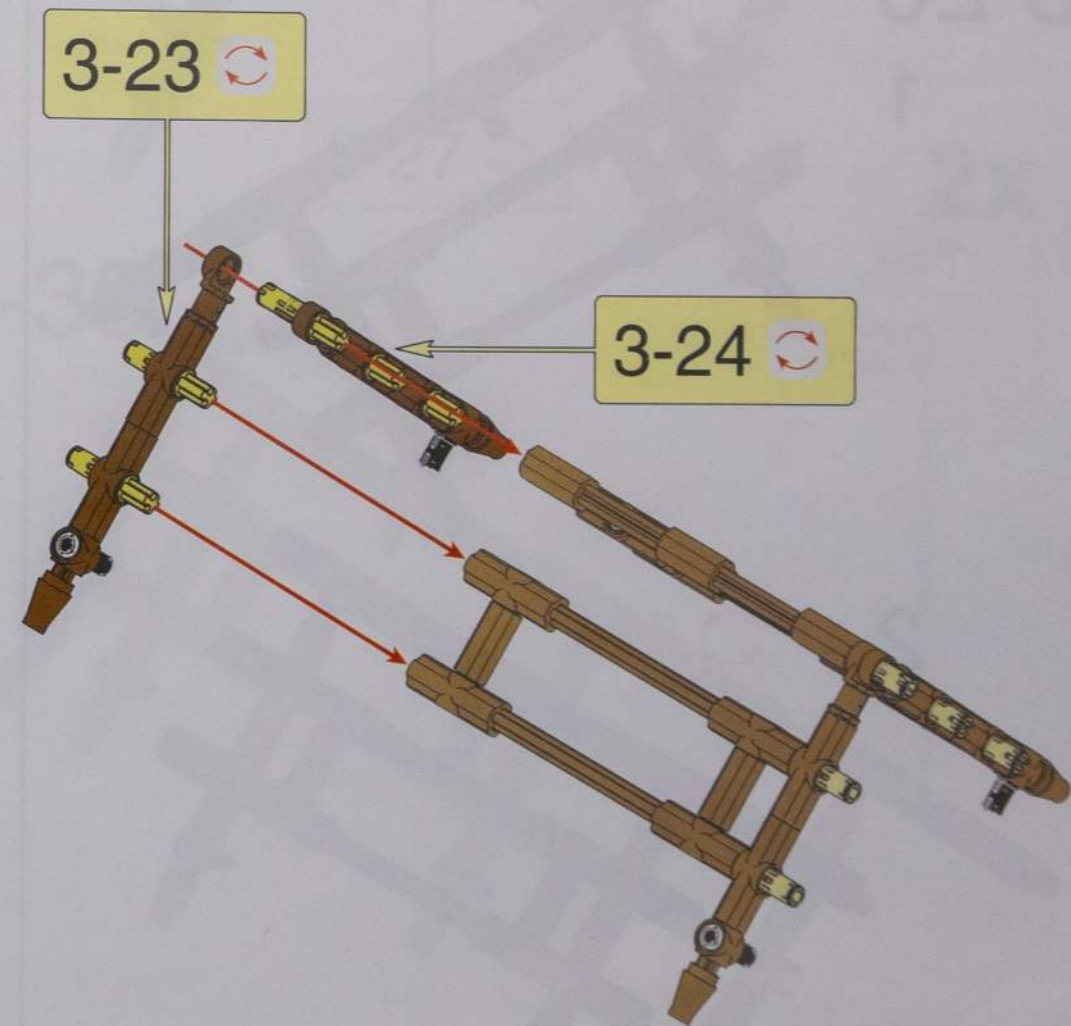

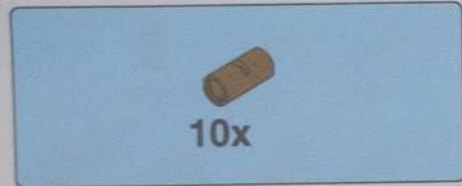

3-26

1

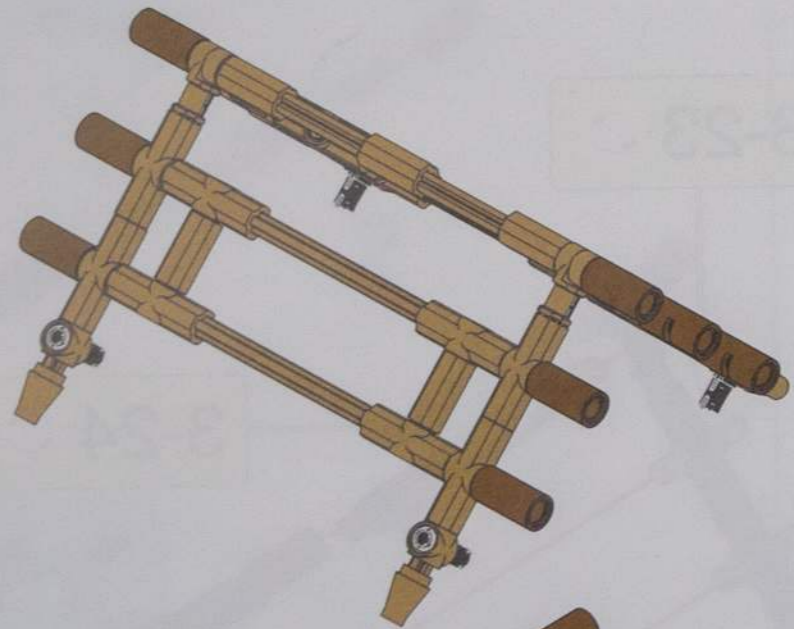

2

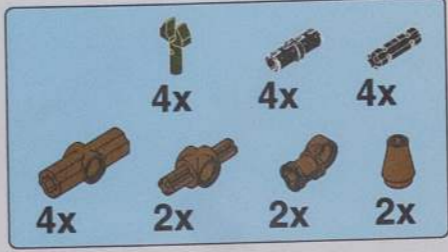
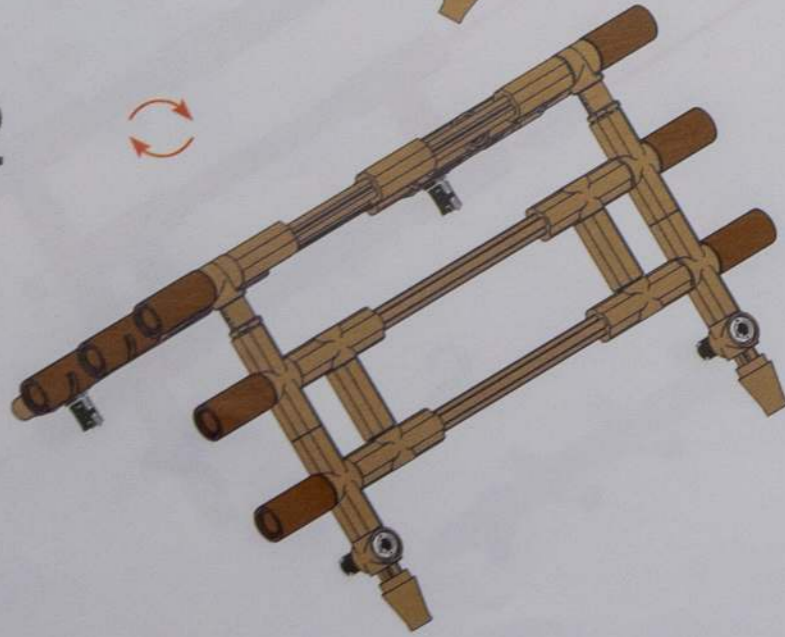

3-27

1

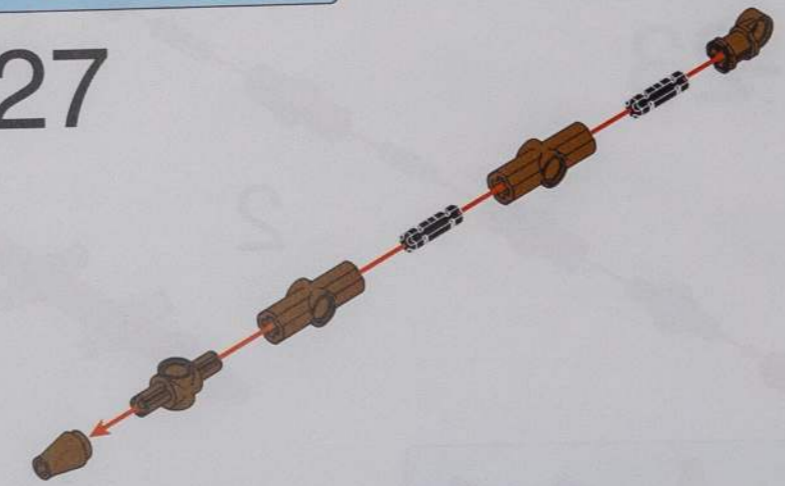

2

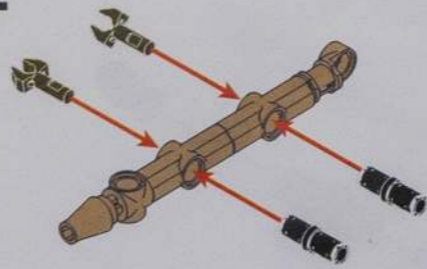

3



2x

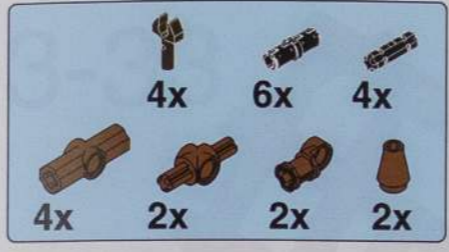

3-28

1

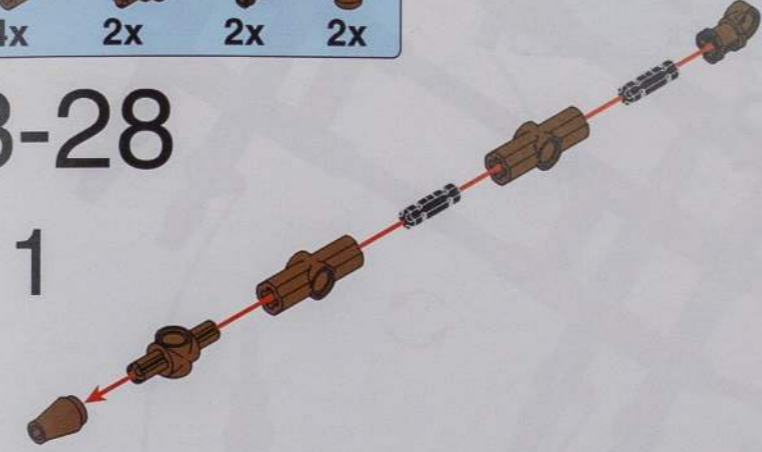

2

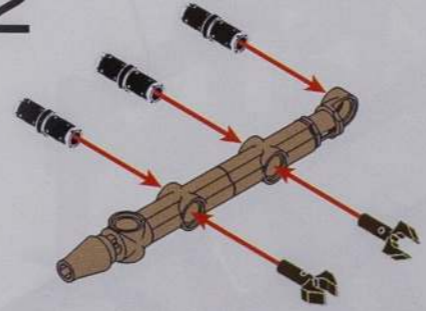

3



2x

3-29

1

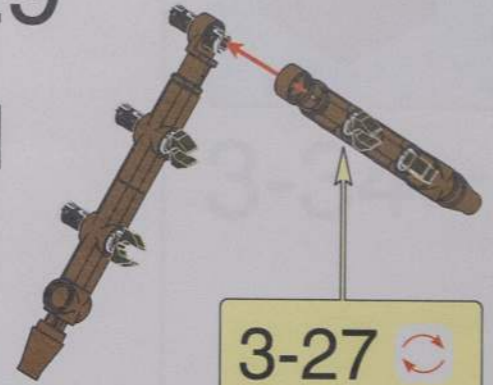

2

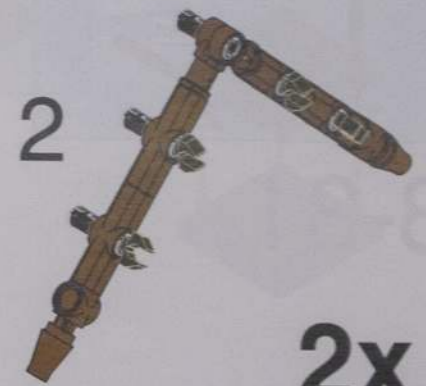

2x

3-30

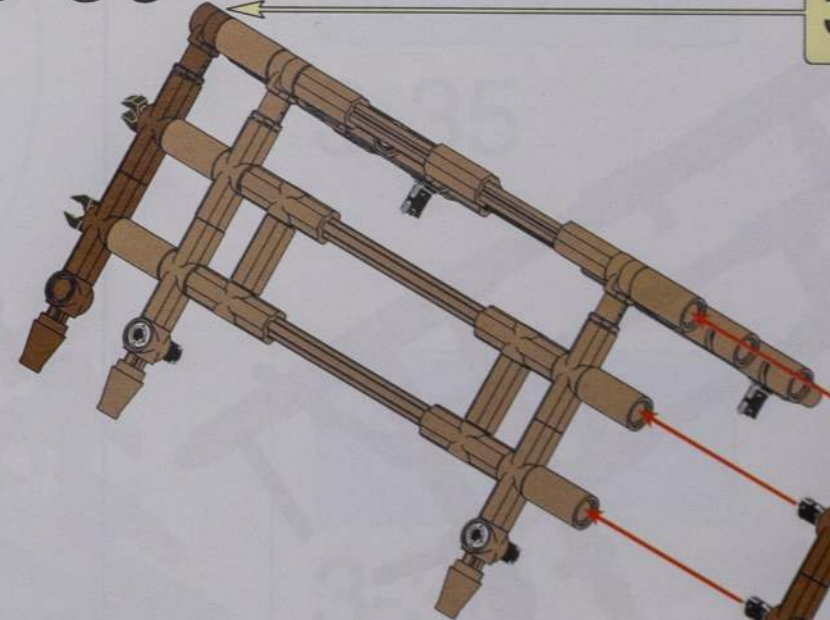

3-29

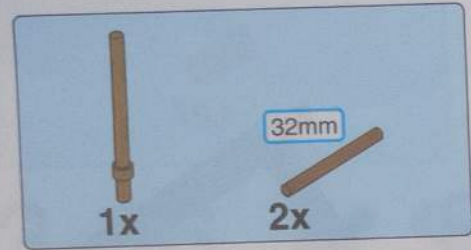

3-31

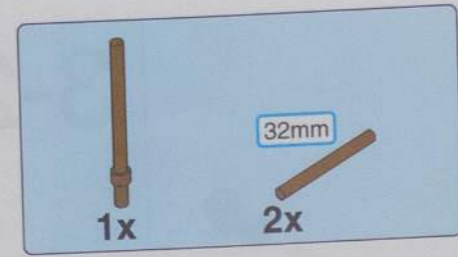
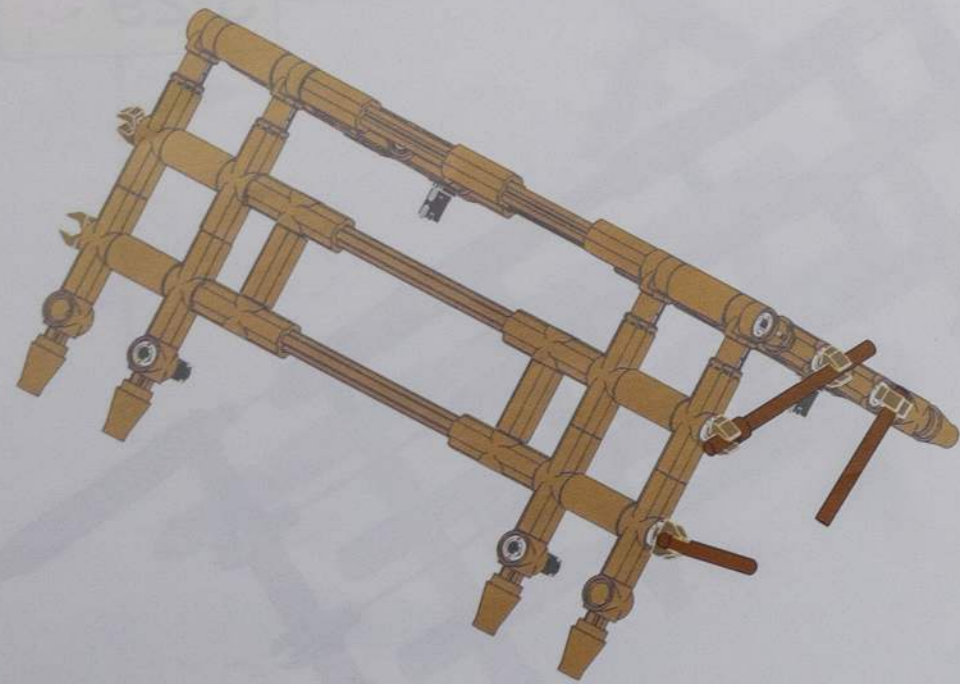

3-32

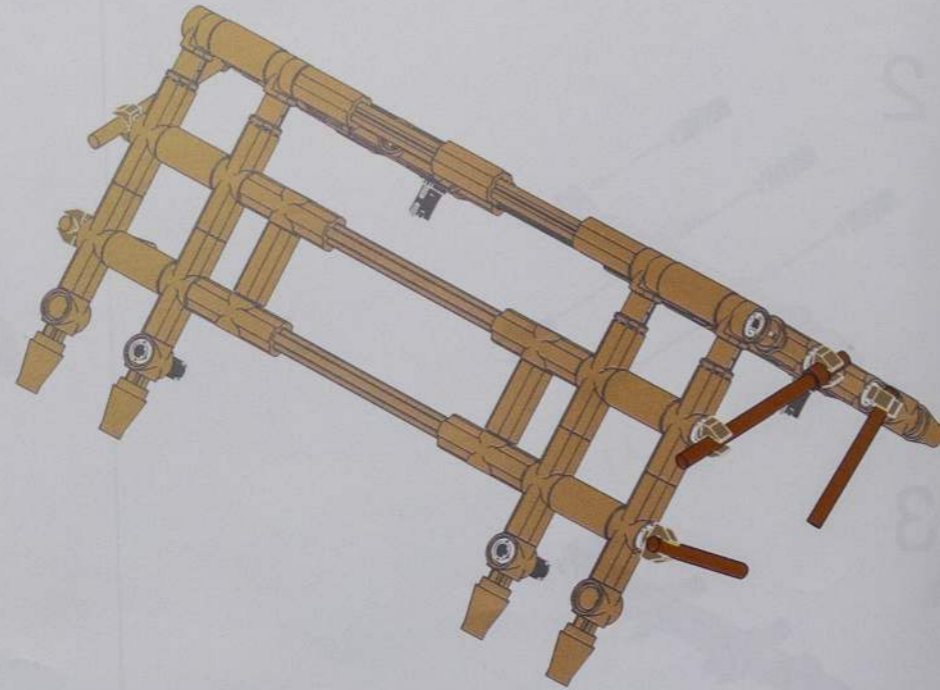

3-33

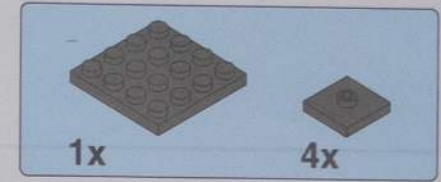
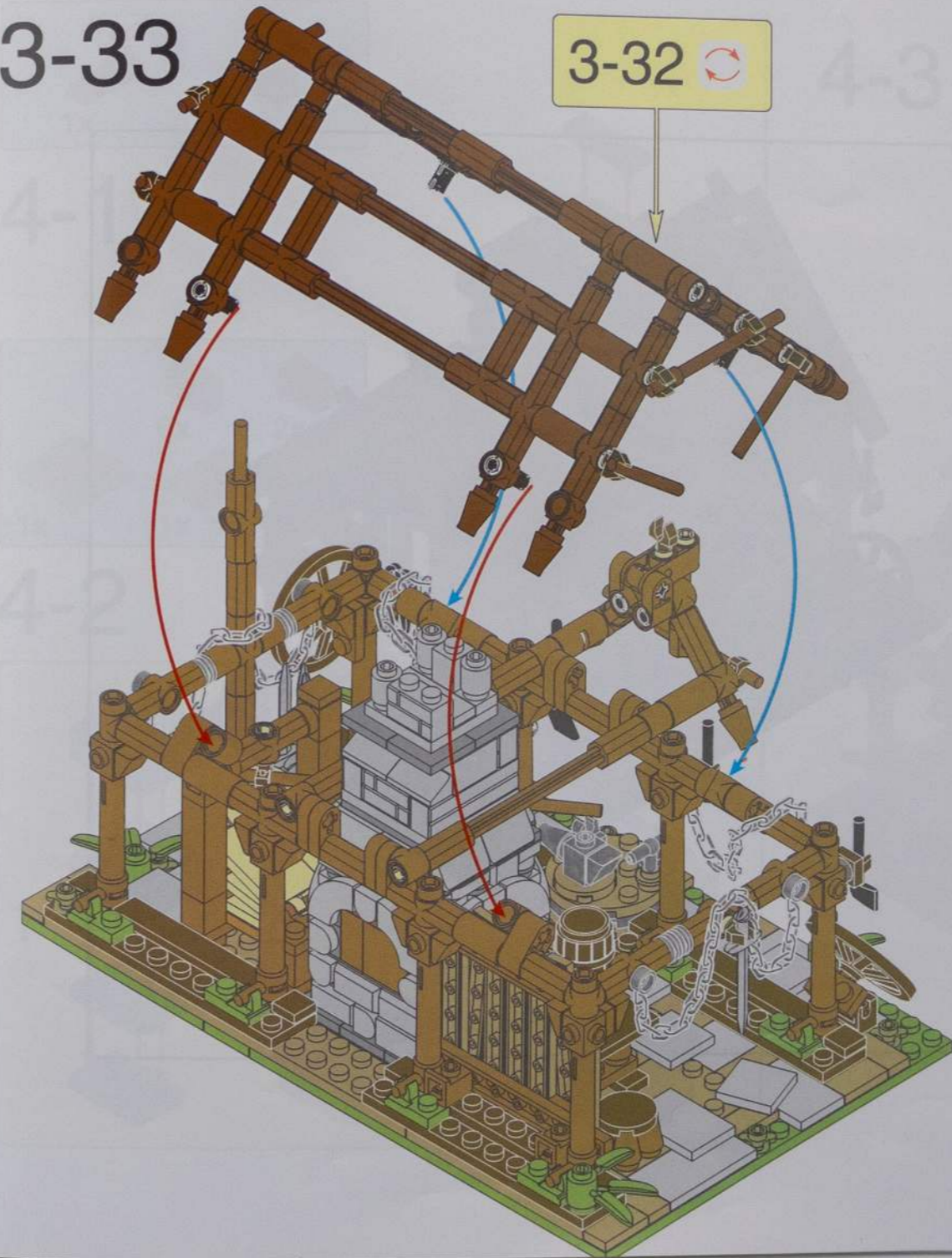

3-34

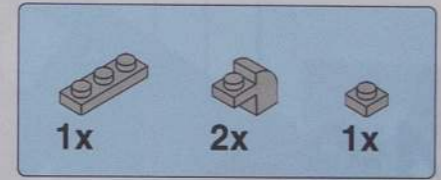
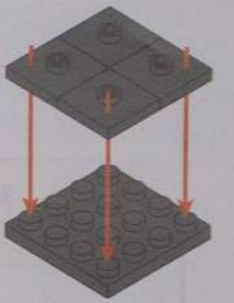

3-35

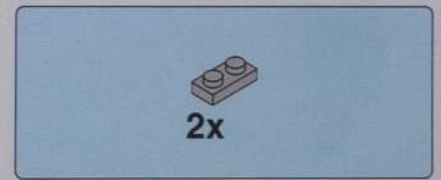
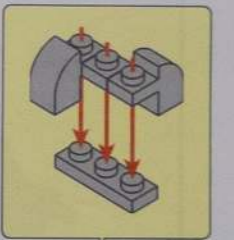

3-36

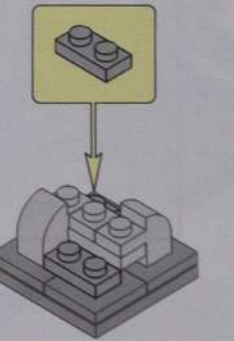

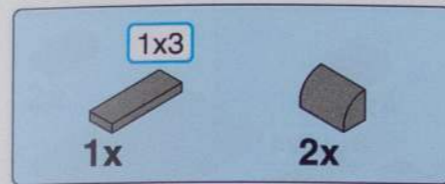
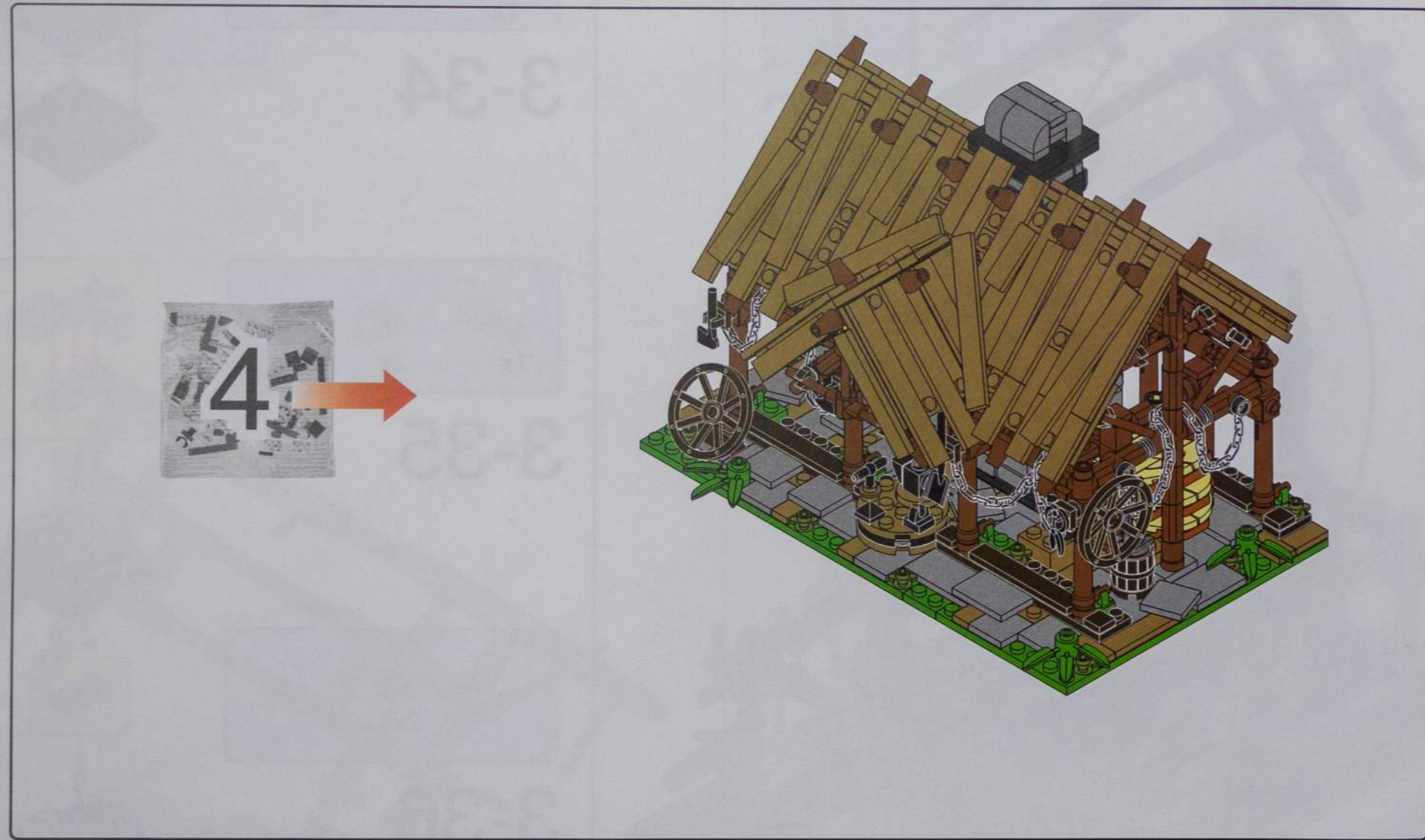

4-1

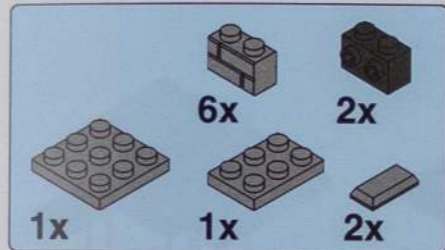
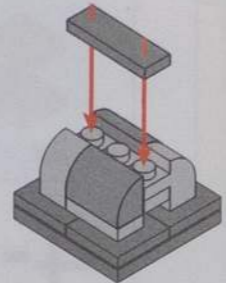

4-2

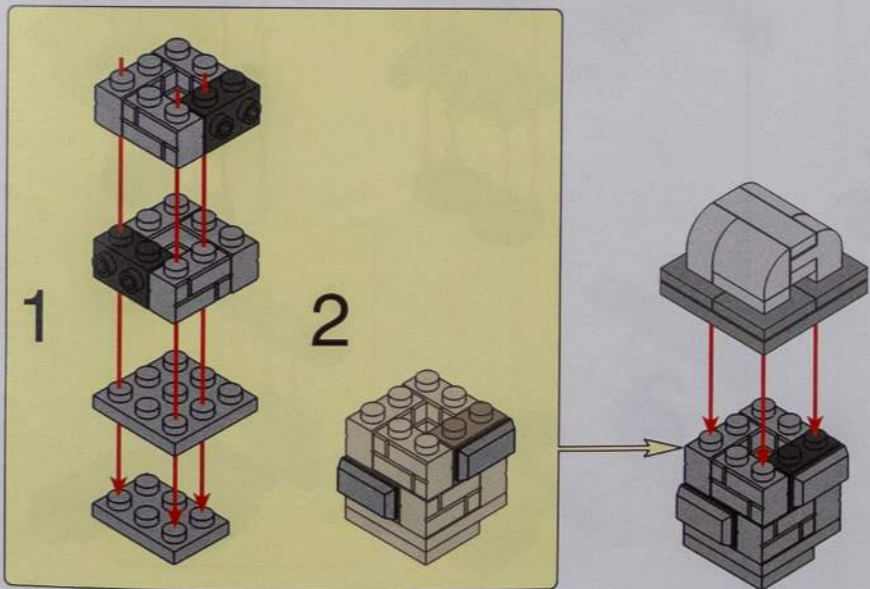

4-3

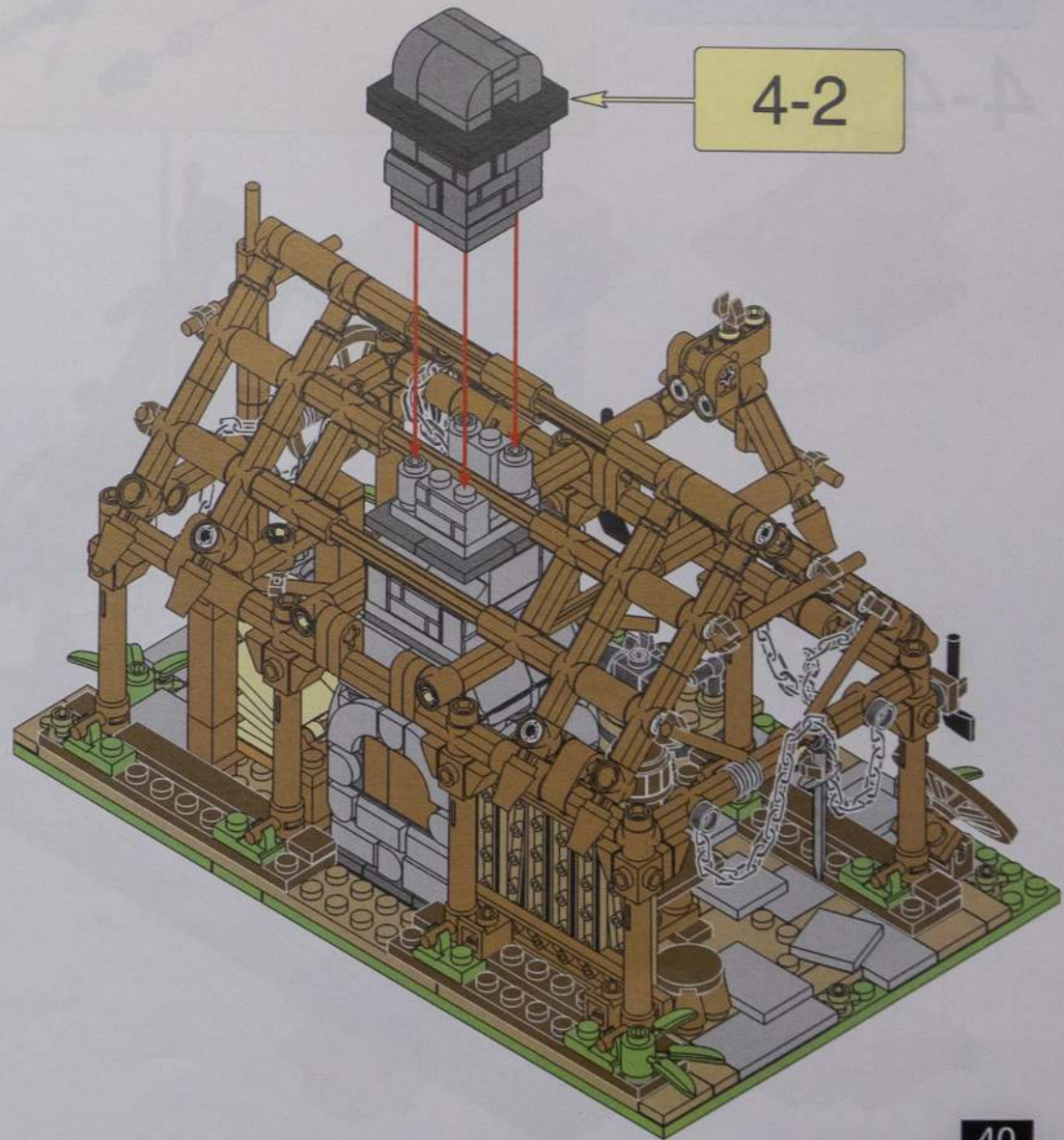

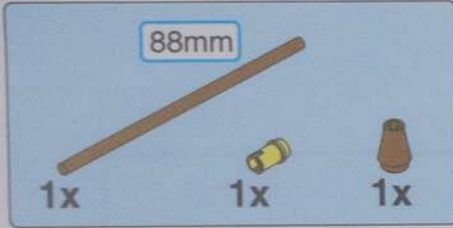

4-4

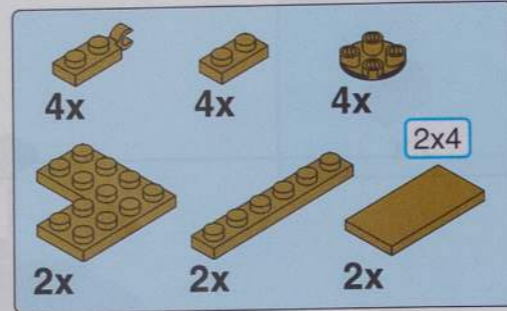
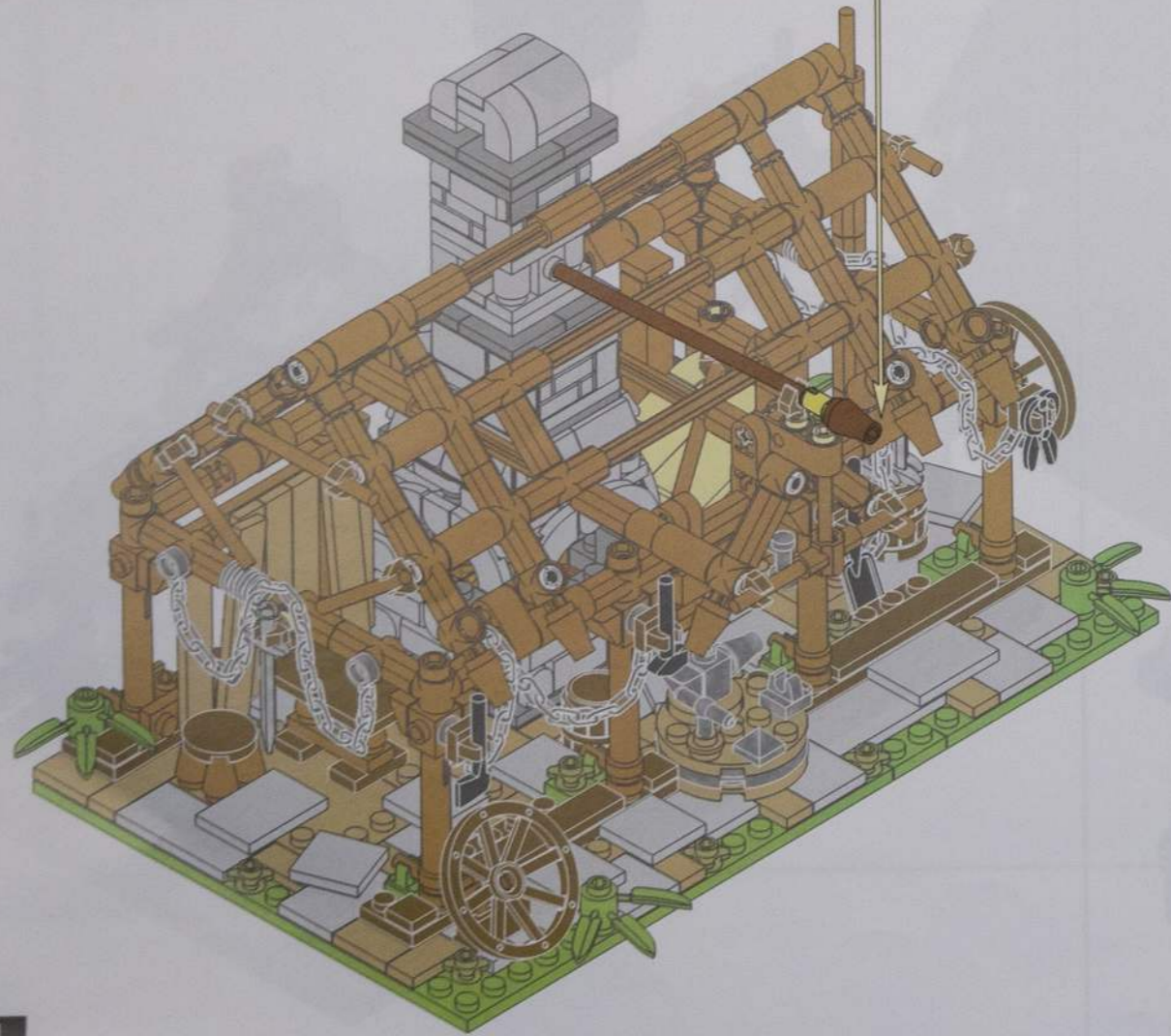
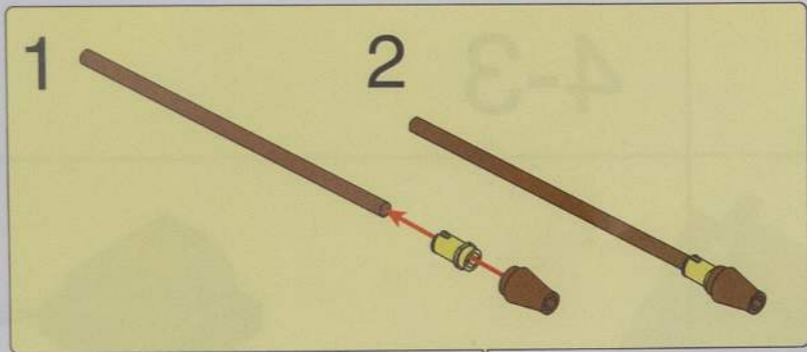

4-5

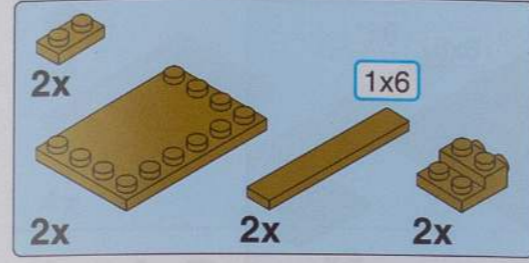
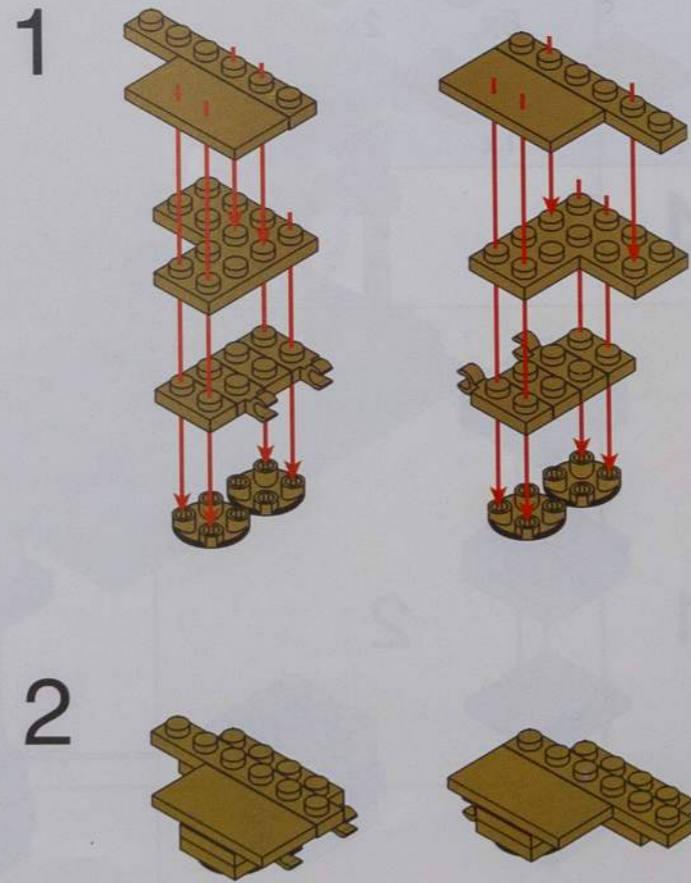

4-6

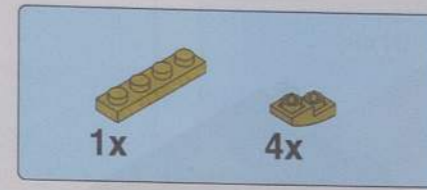
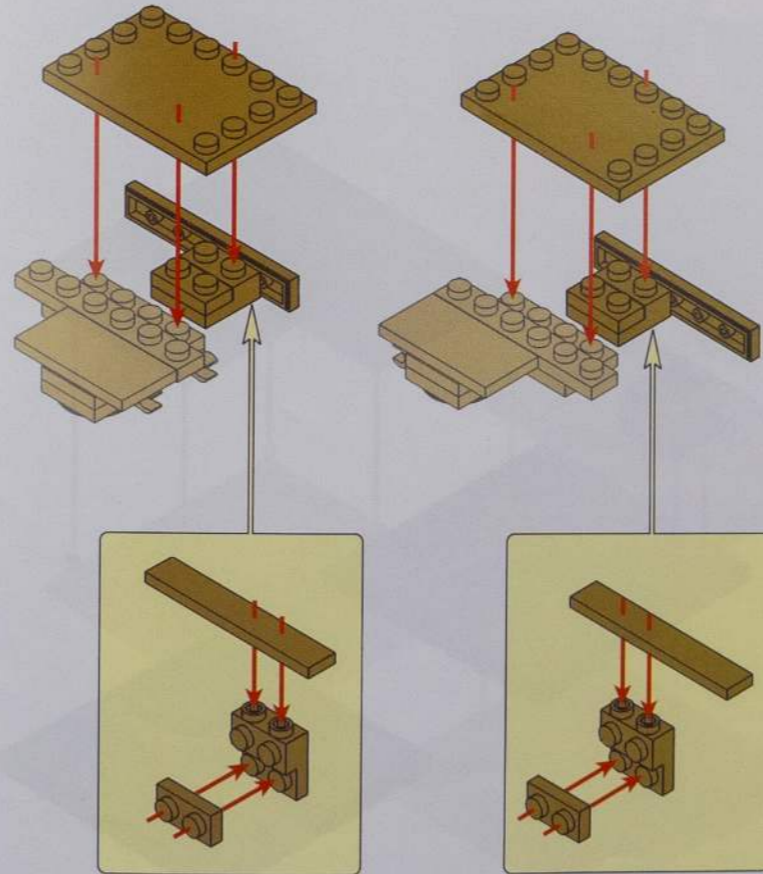

4-7

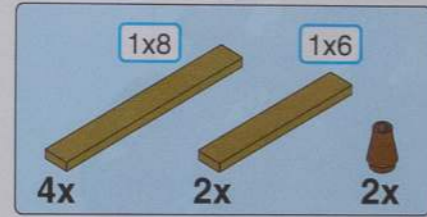
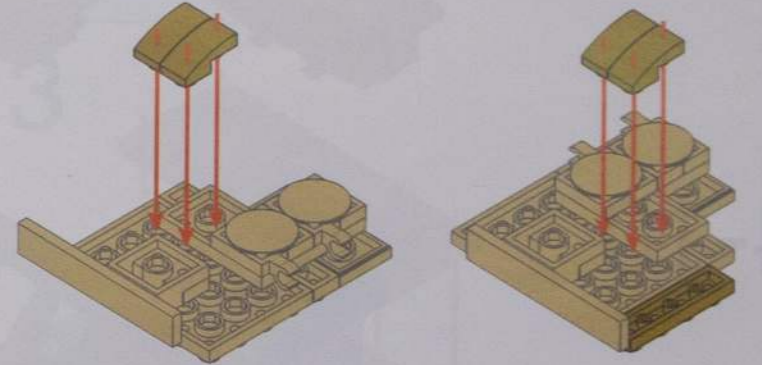

4-8

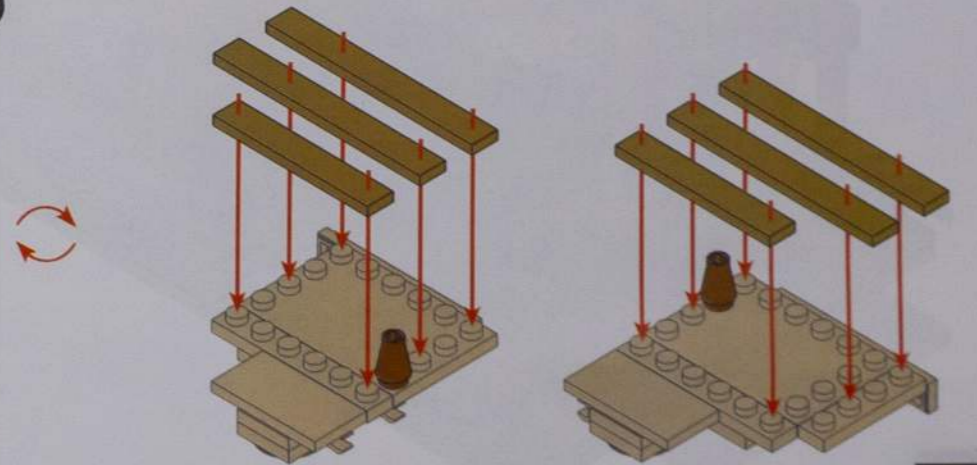

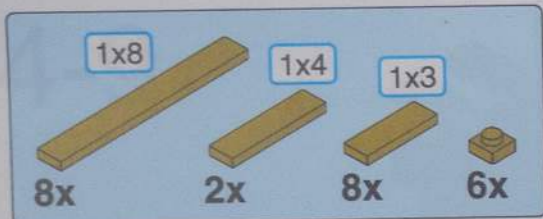

4-14

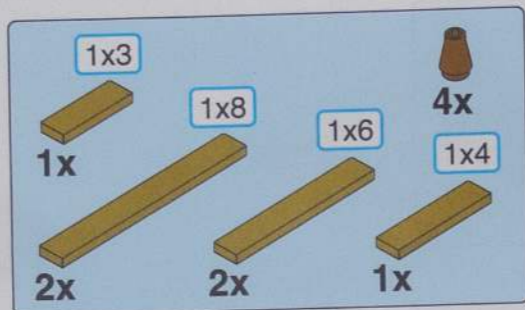
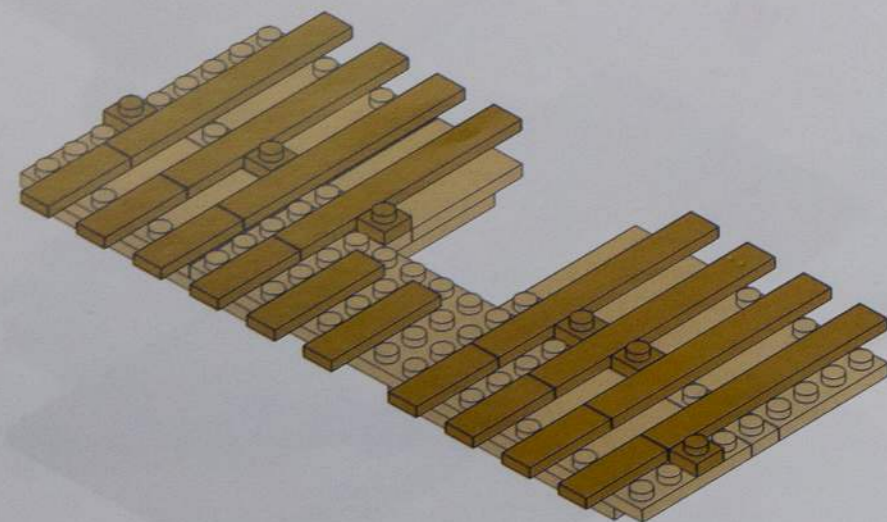

4-15

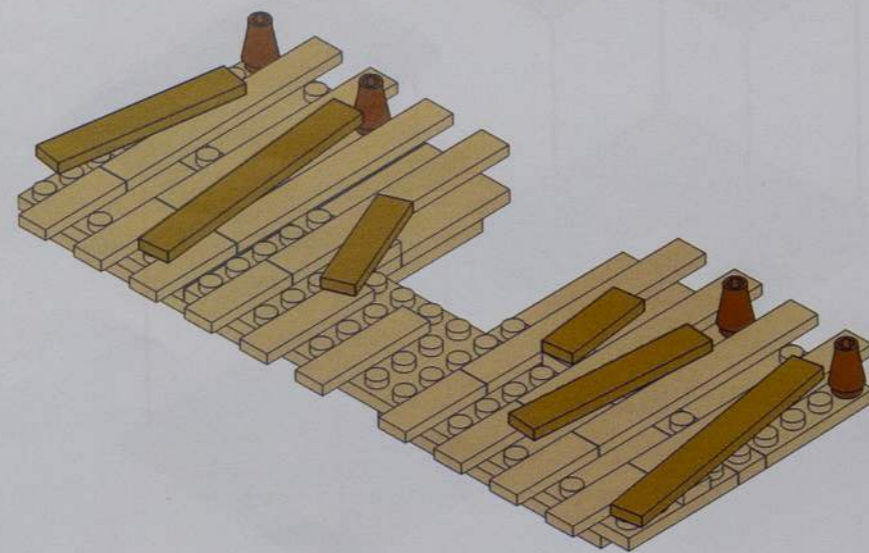

4-16

4-15 ↻

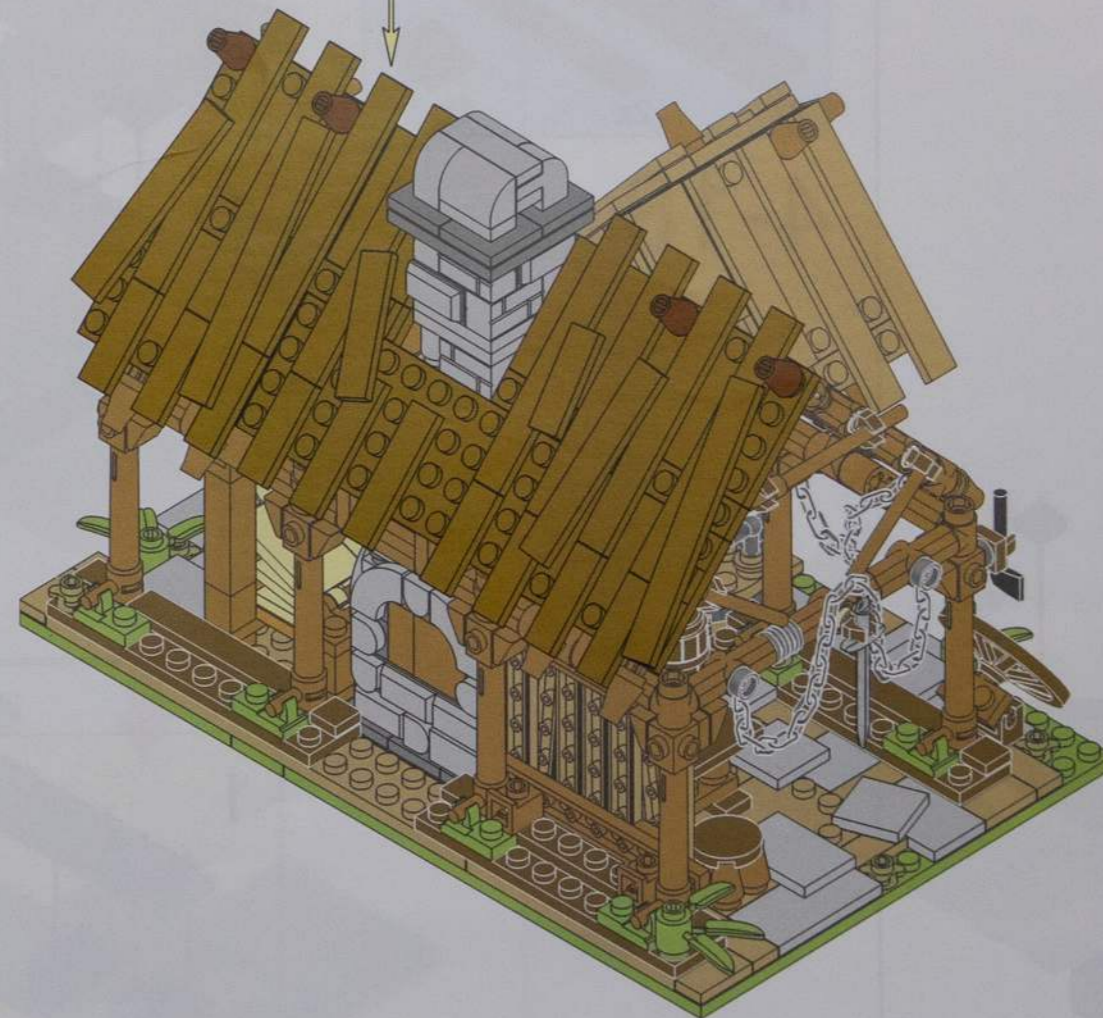

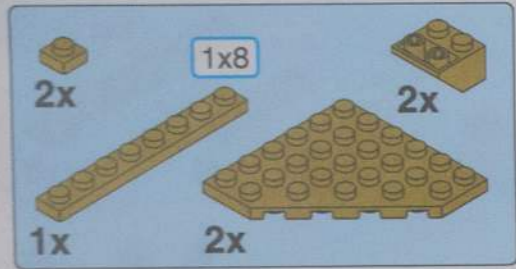

4-17

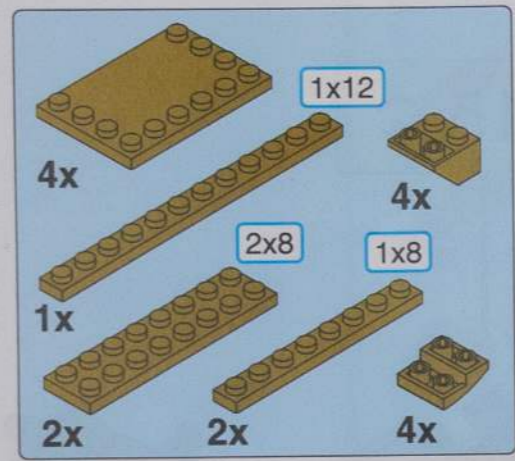
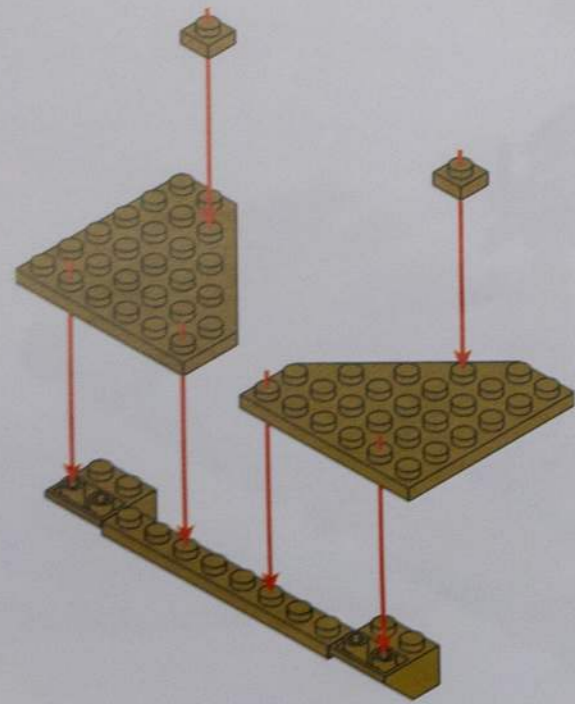

4-18

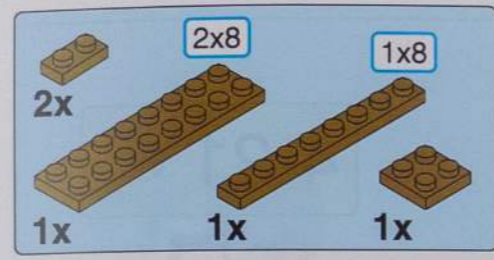
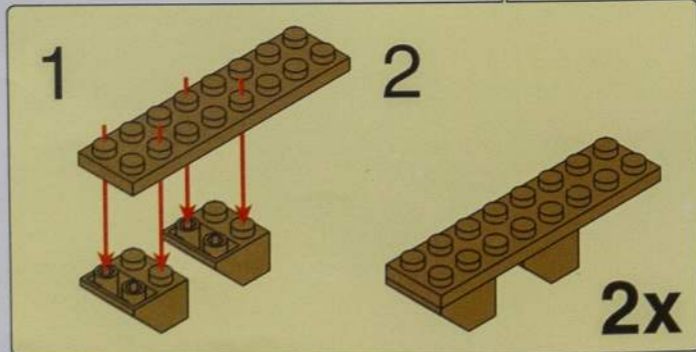
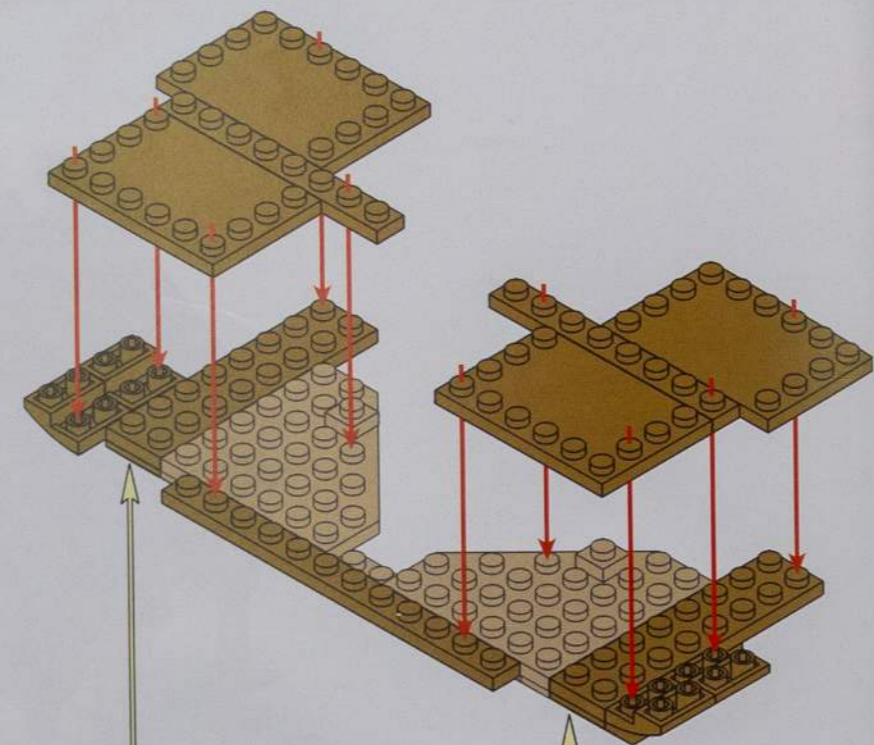

4-19

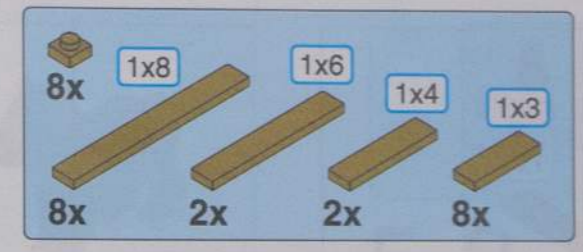
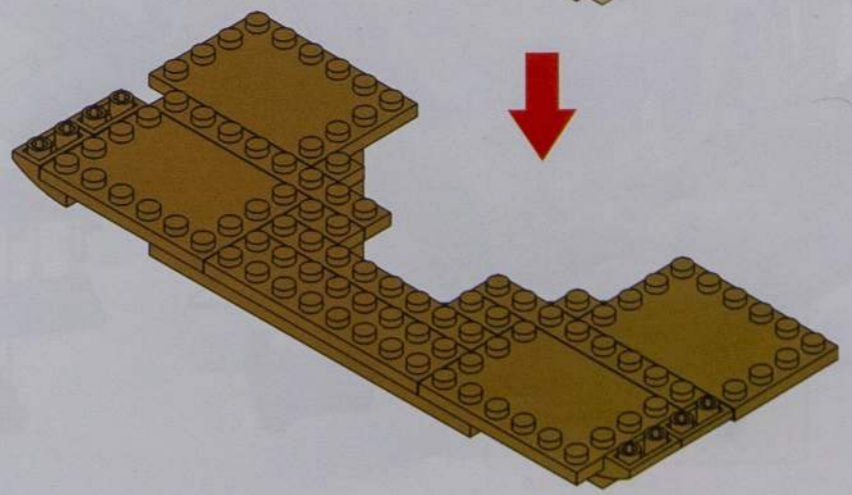
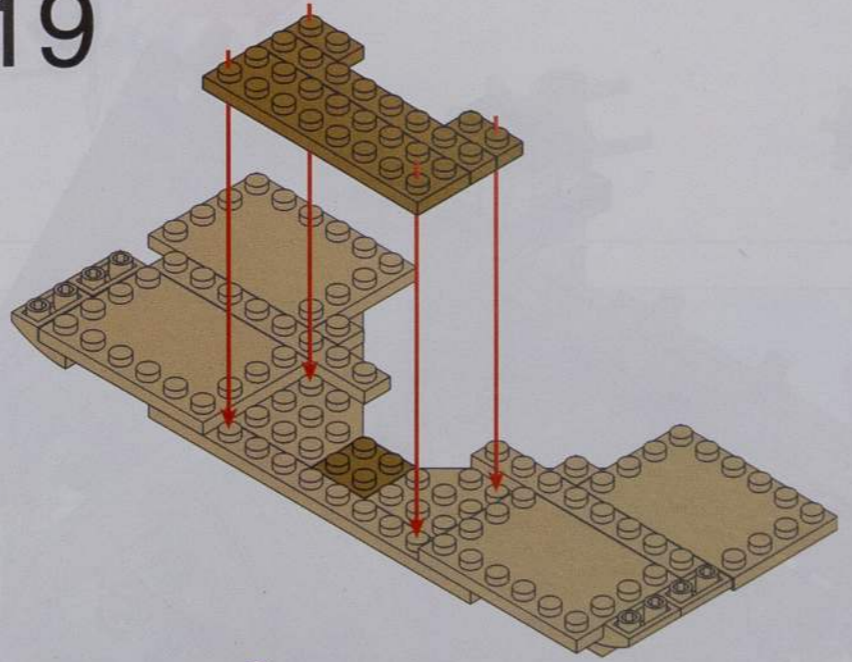

4-20

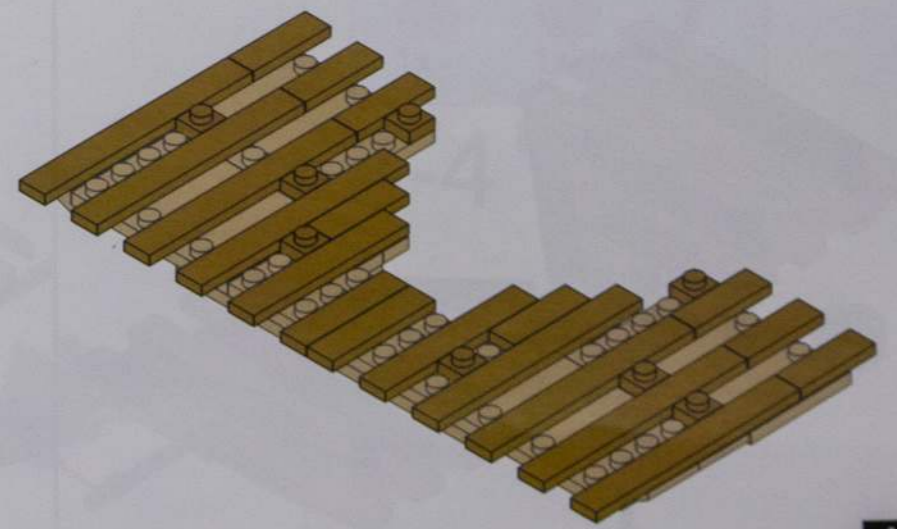

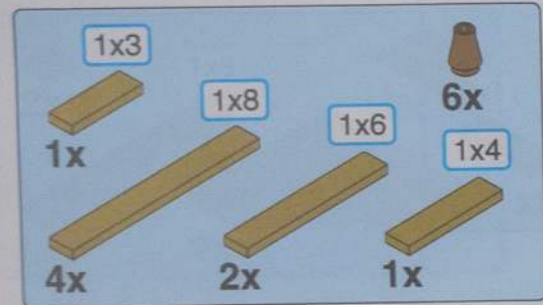

4-21

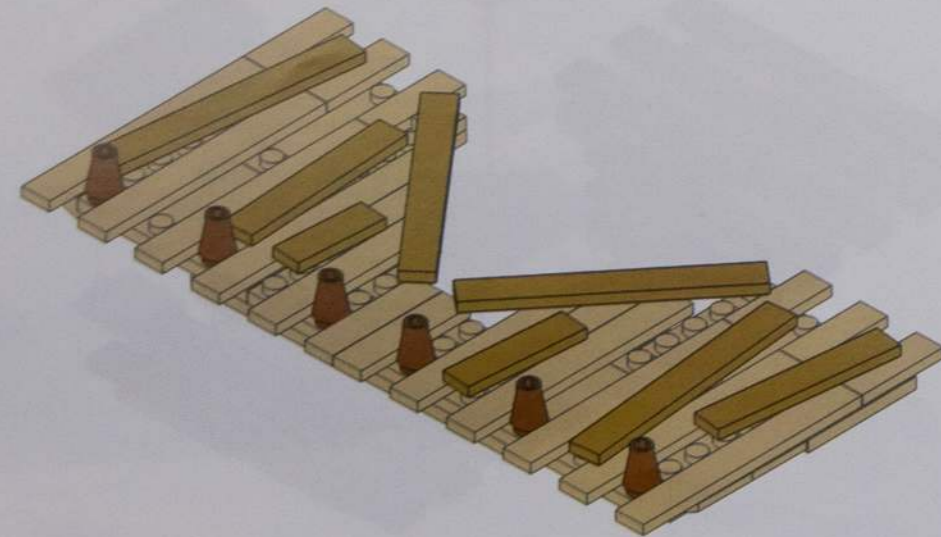

4-22

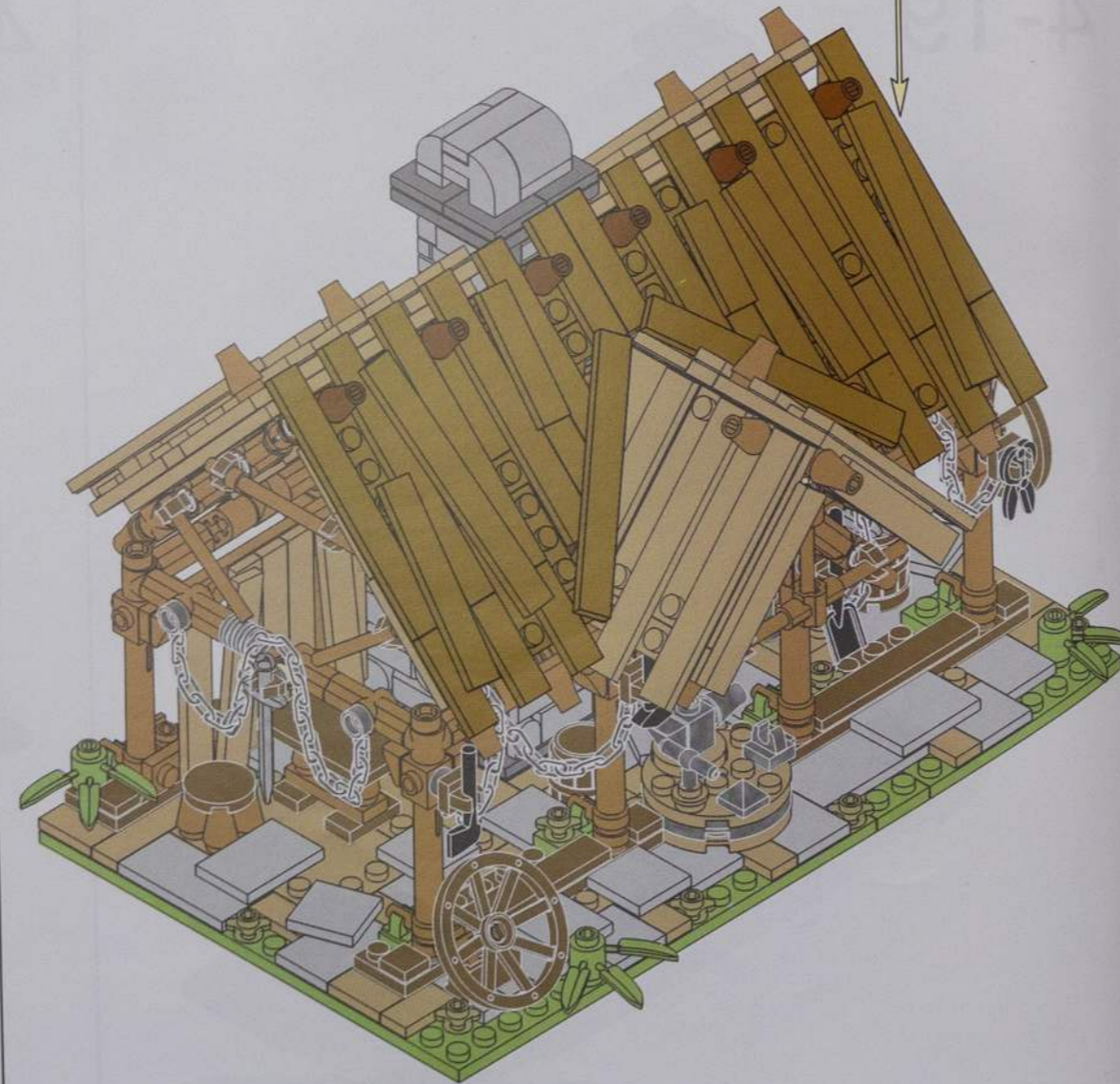

4-21

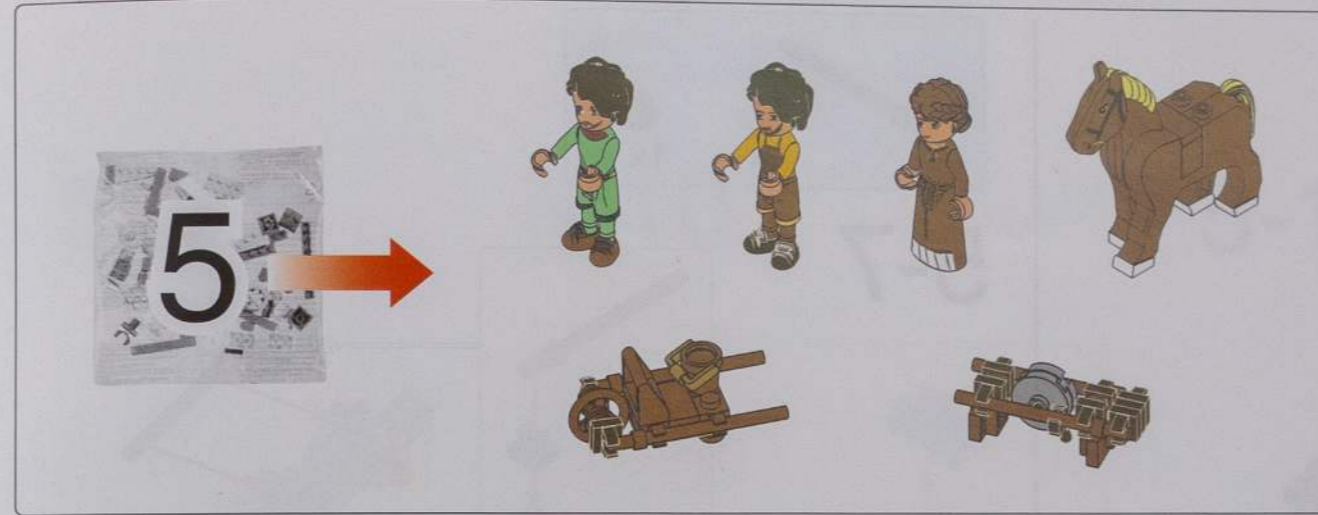

5-1

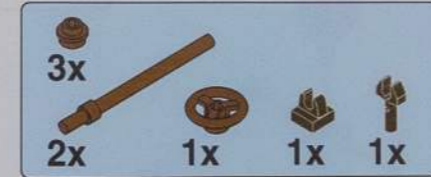
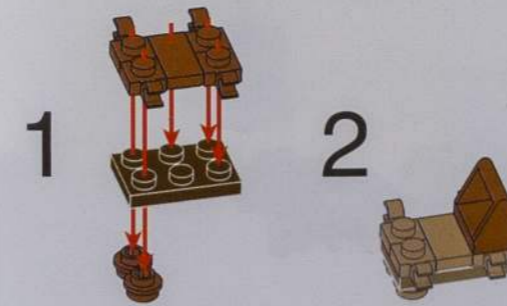

5-2

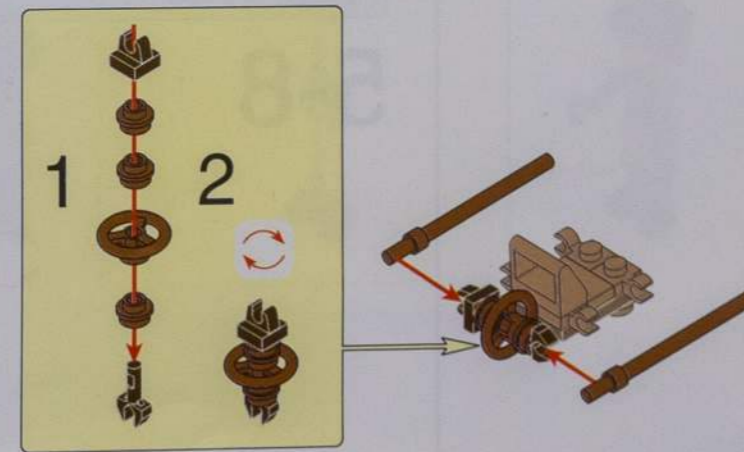

5-3

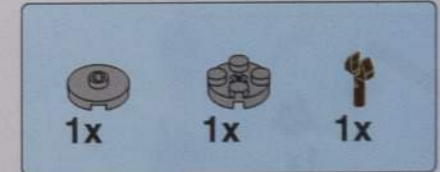
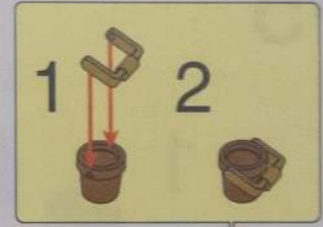

5-4

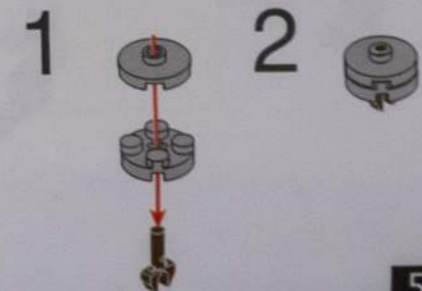

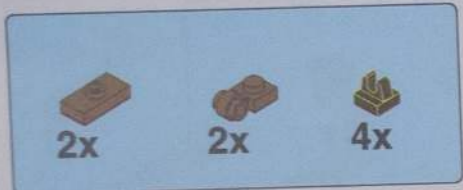

5-5

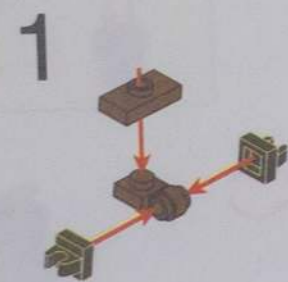

2



2x



5-6

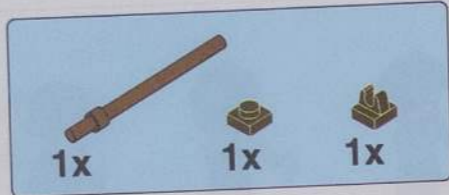
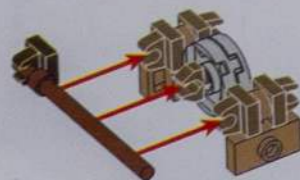

5-7

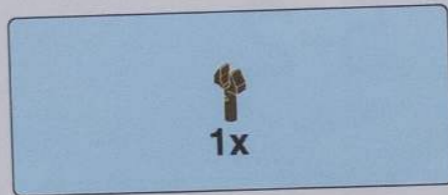
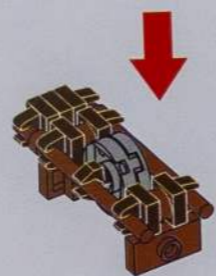
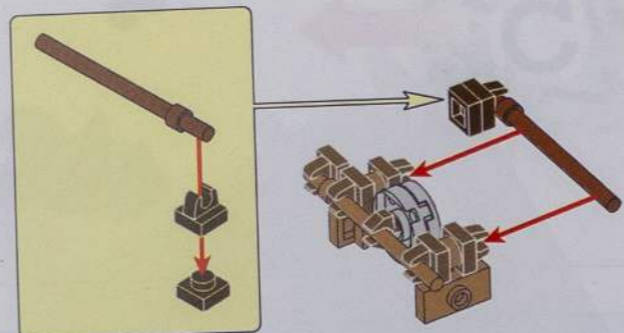

5-8

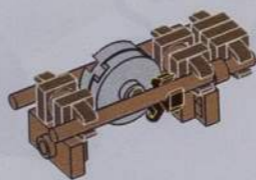

5-9

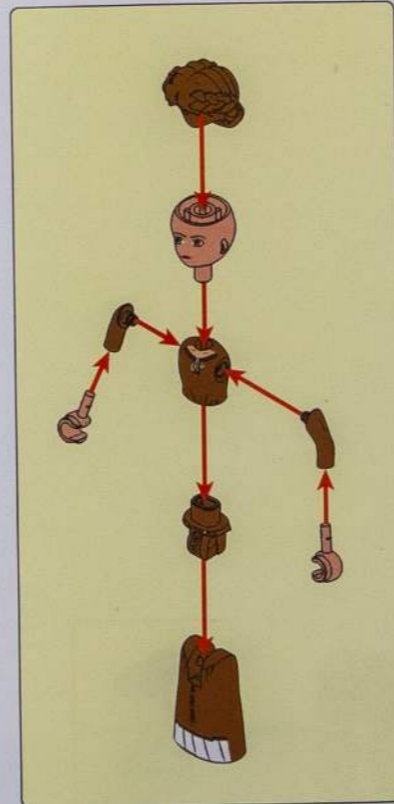

5-10

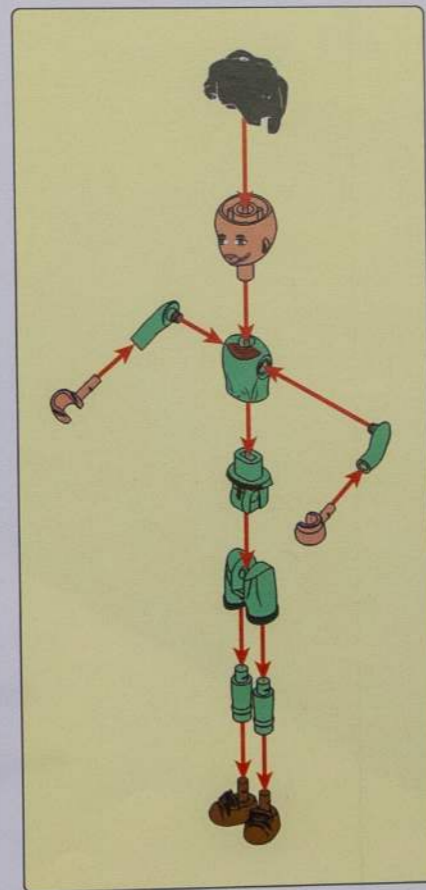

5-11

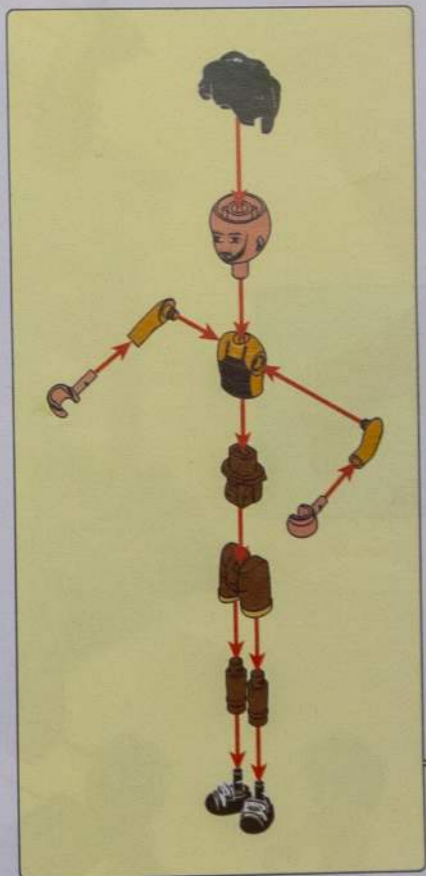

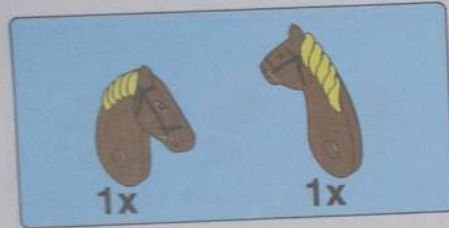

5-12

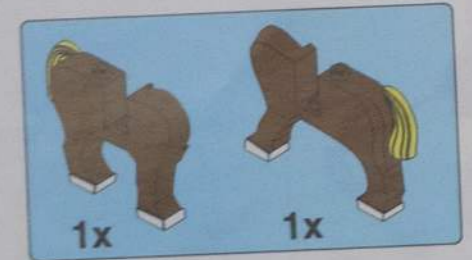
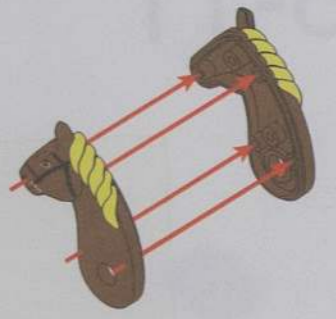

5-13

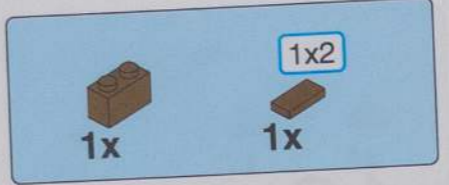
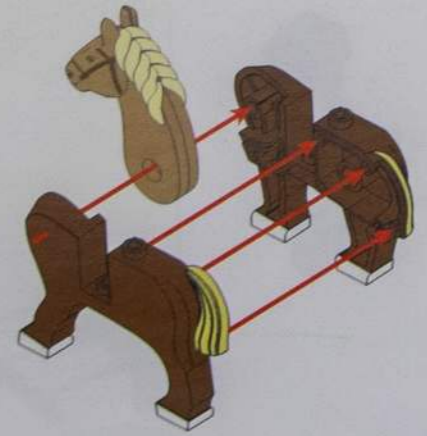

5-14

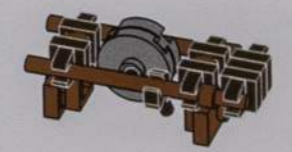
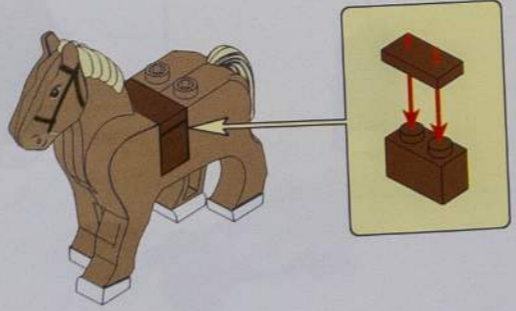



Kingdom Come
Deliverance

for
Blue Brixx

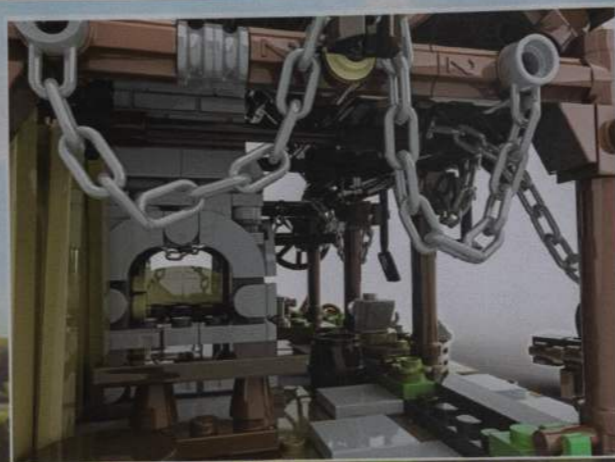

Kingdom Come
Deliverance

for
Blue Brixx
No. XB-11006

Martins
Schmiede

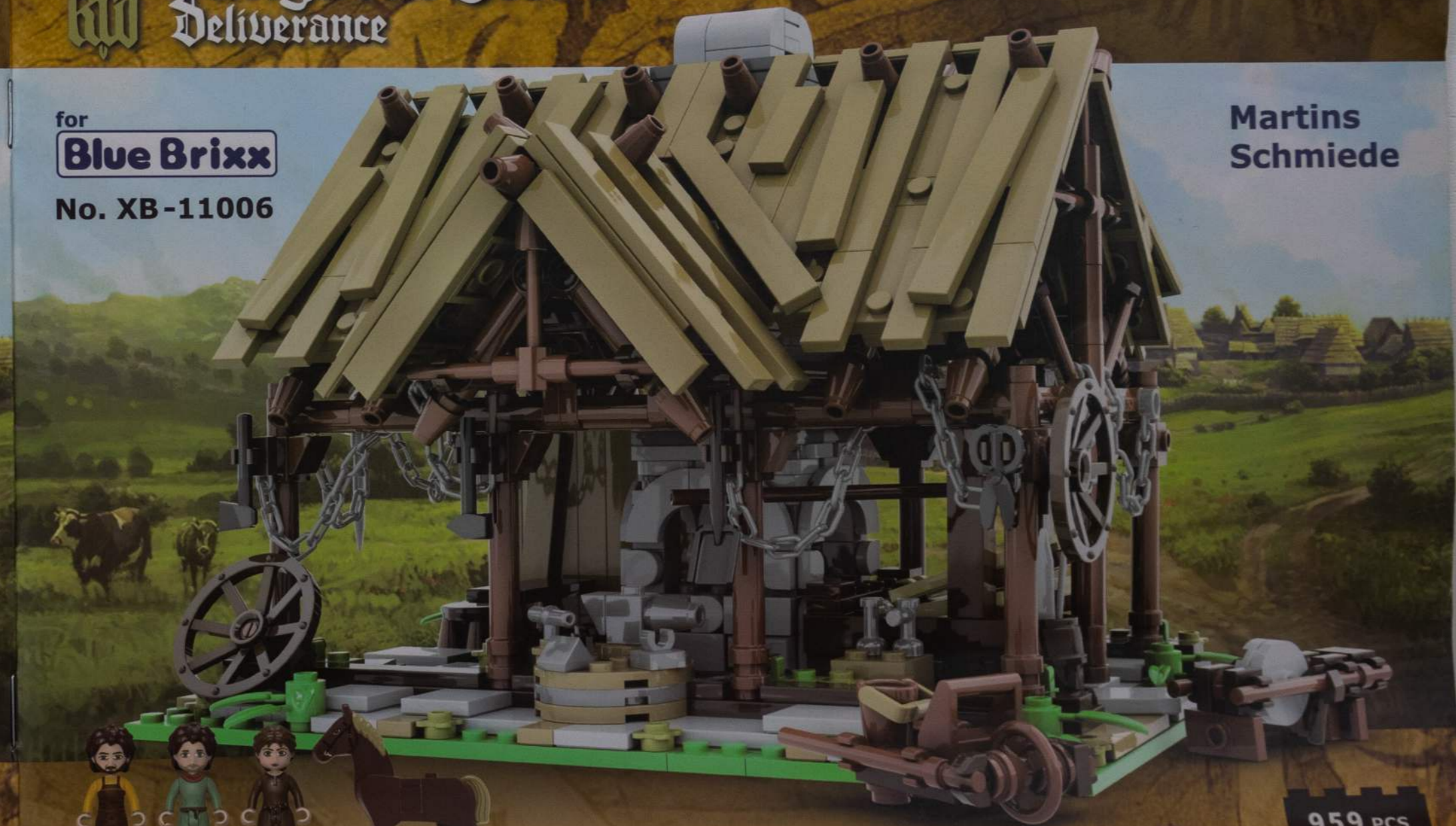

959 PCS

11006-2009-V1