

1

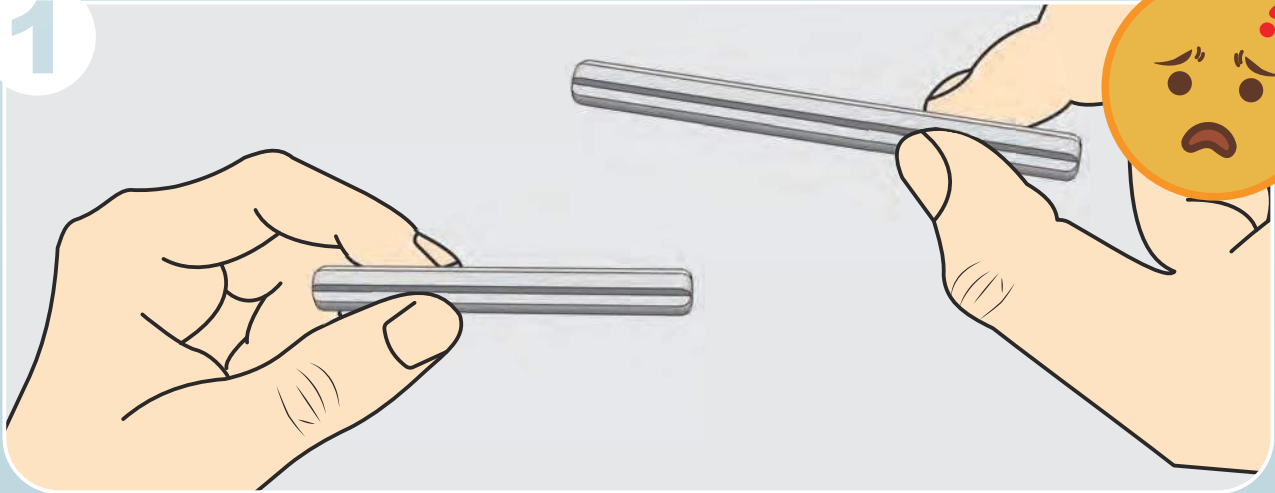

2

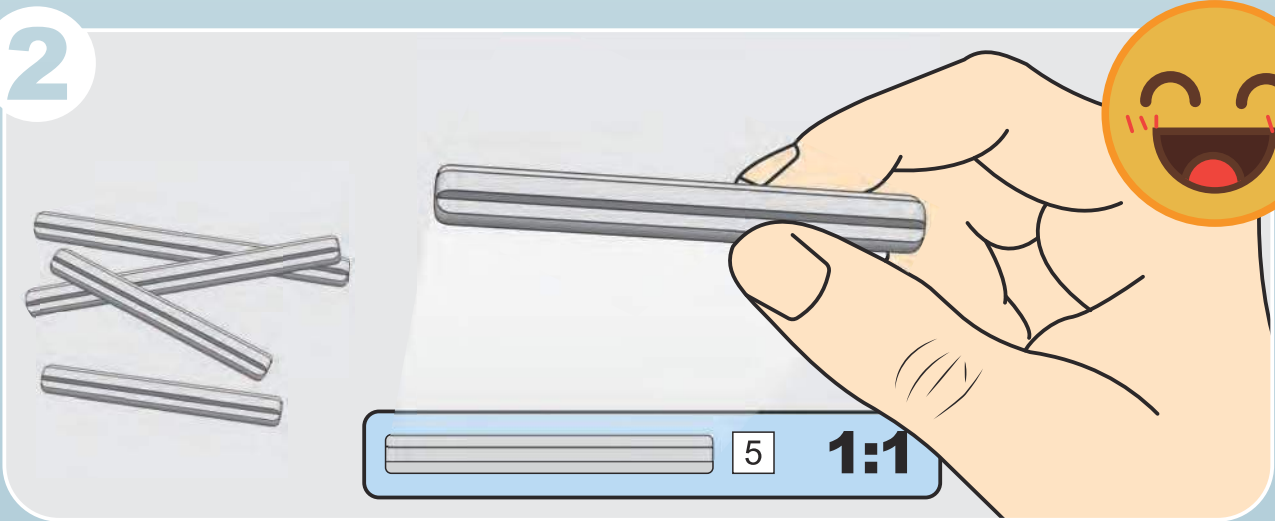

1

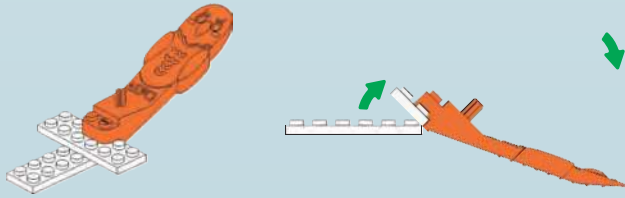

2



3

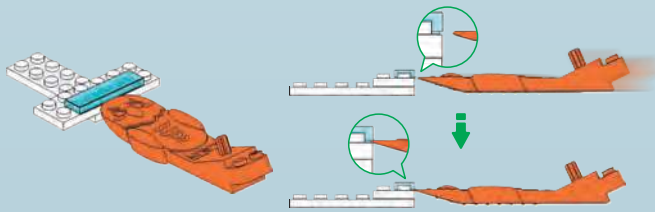

4



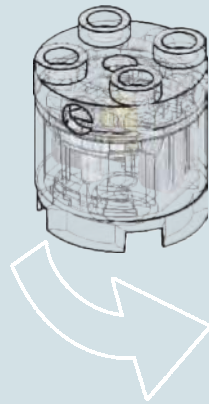
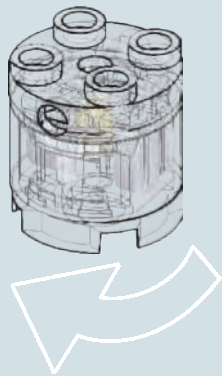



**A**

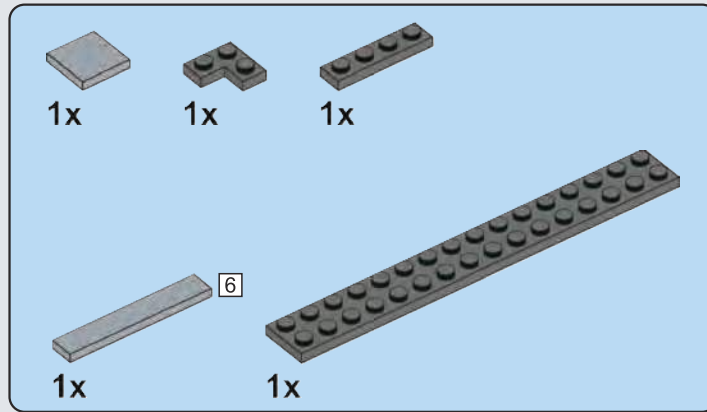

**A1**

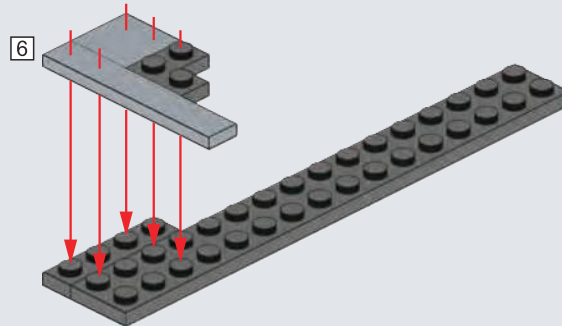

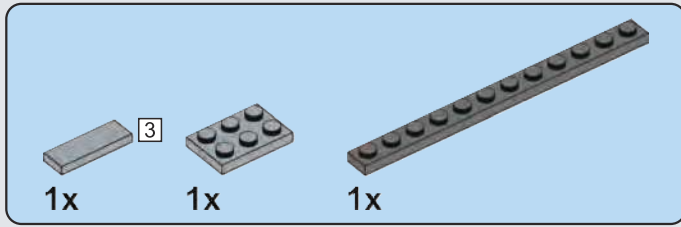

**A2**

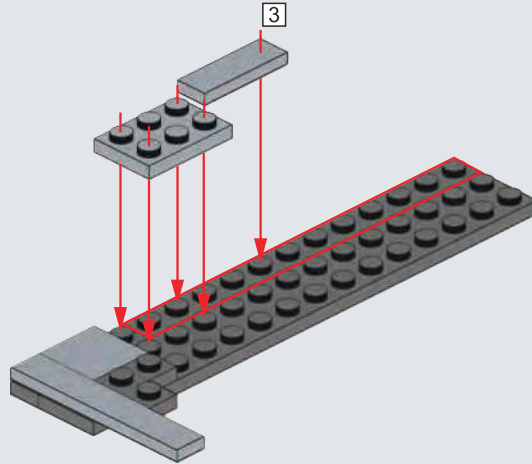

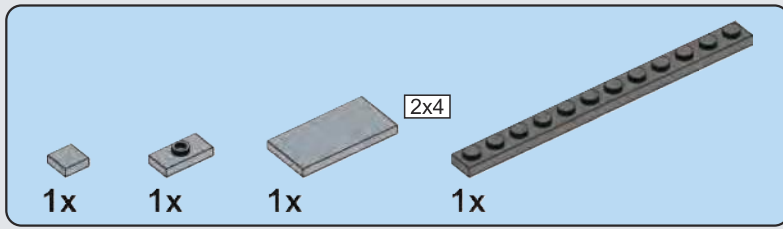

### A3

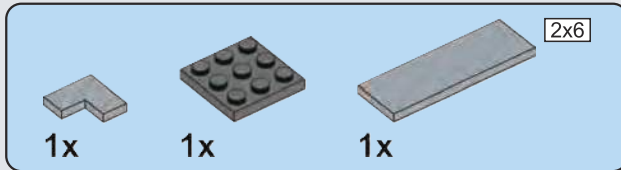
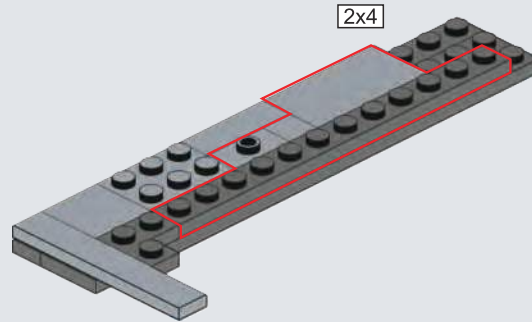

### A4

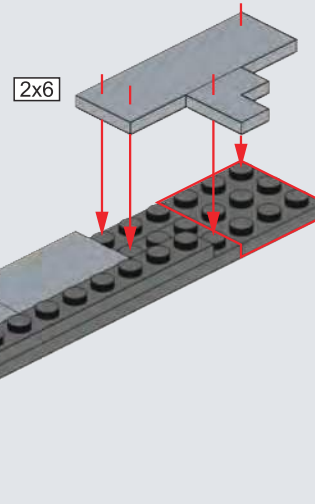

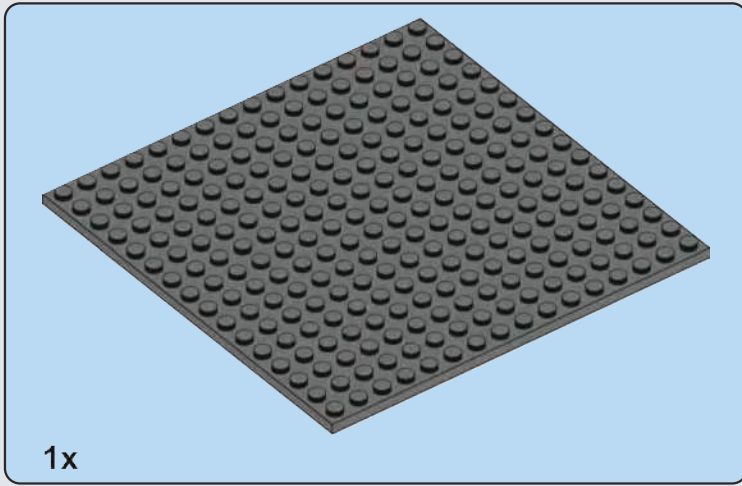

**A5**

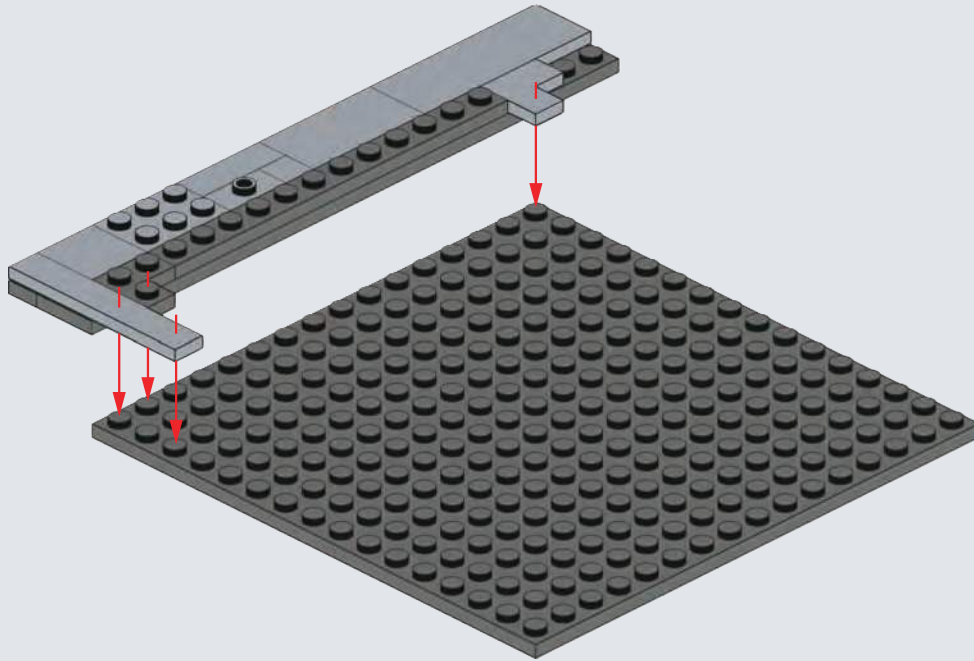

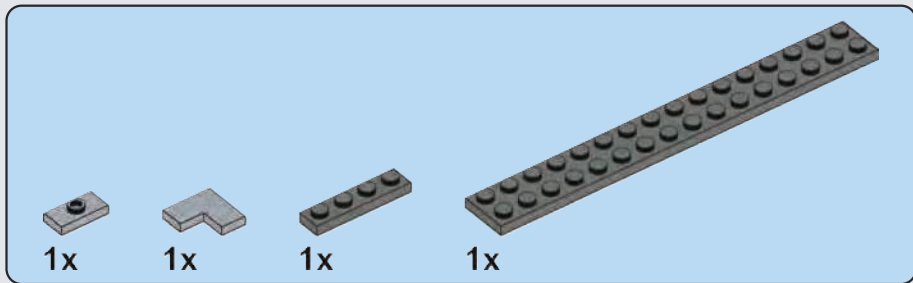

## A6

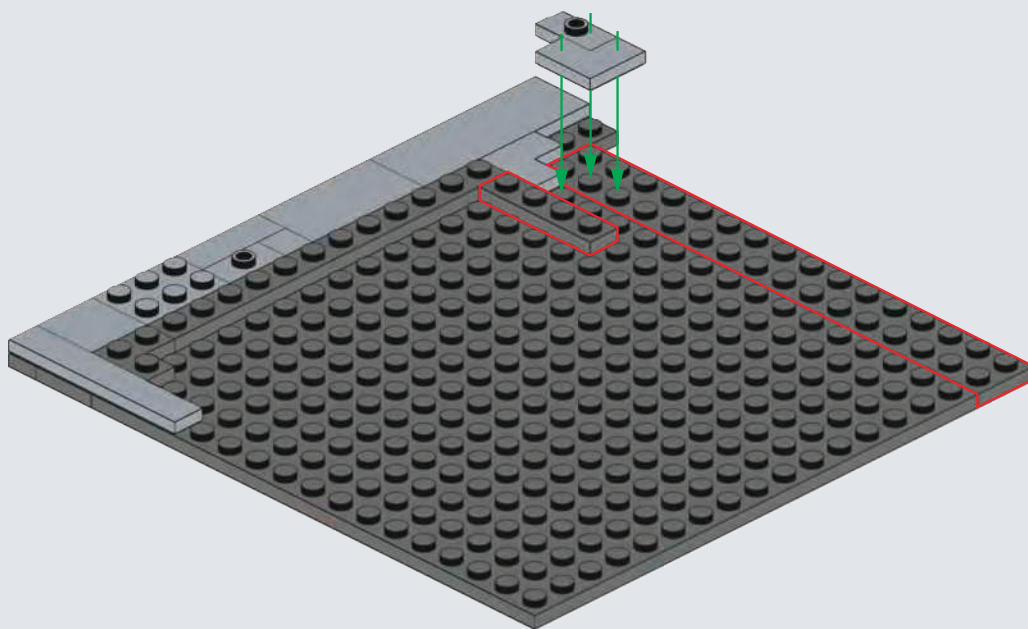

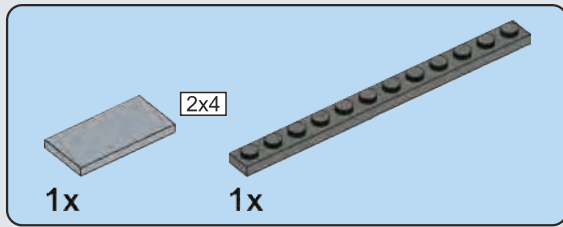

**A7**

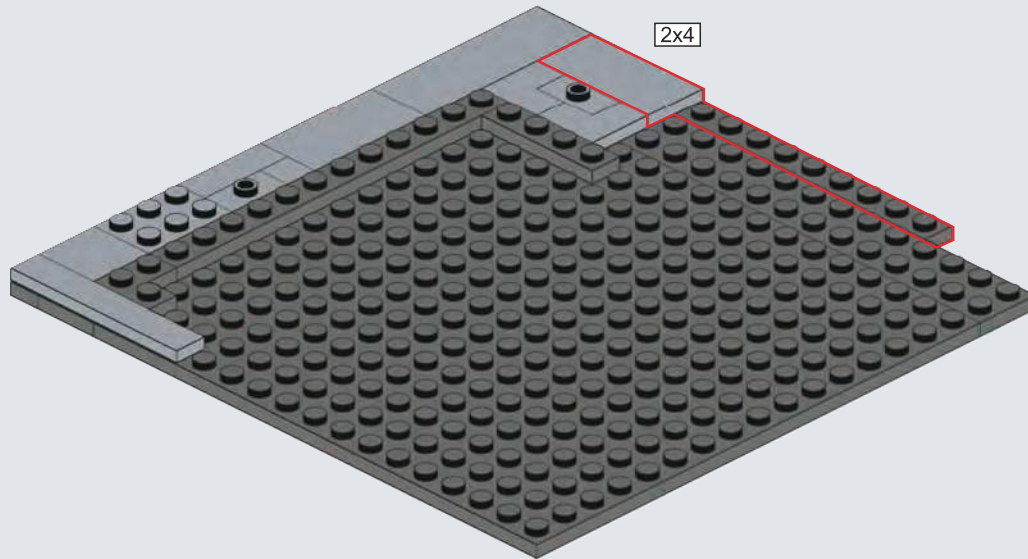

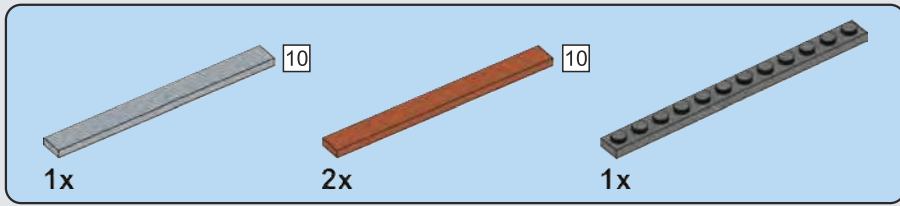

# A8

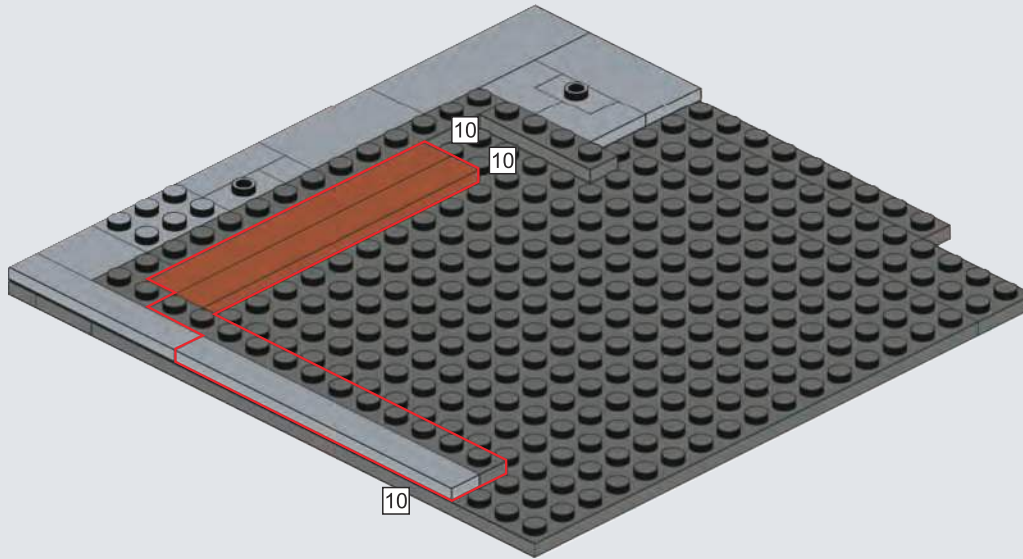

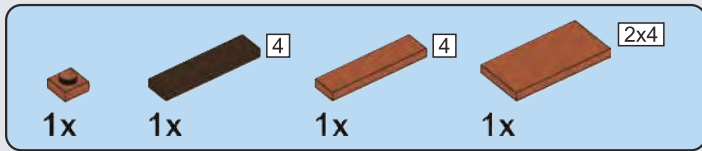

# A9

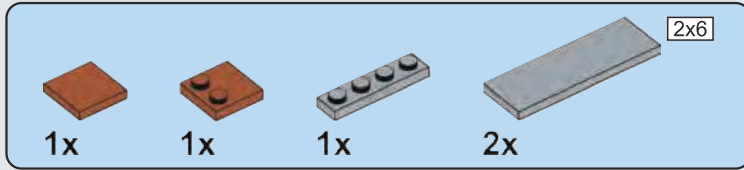
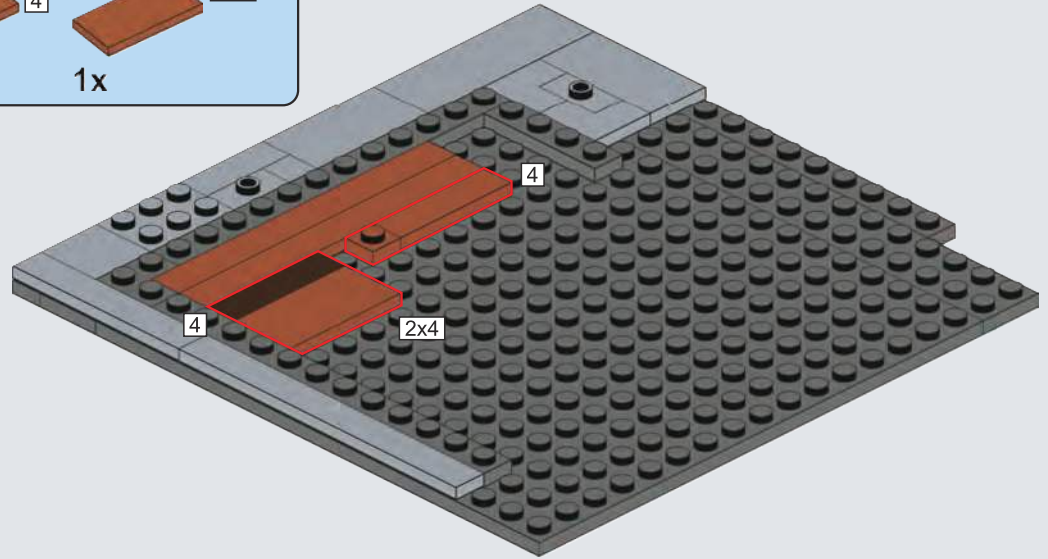

# A10

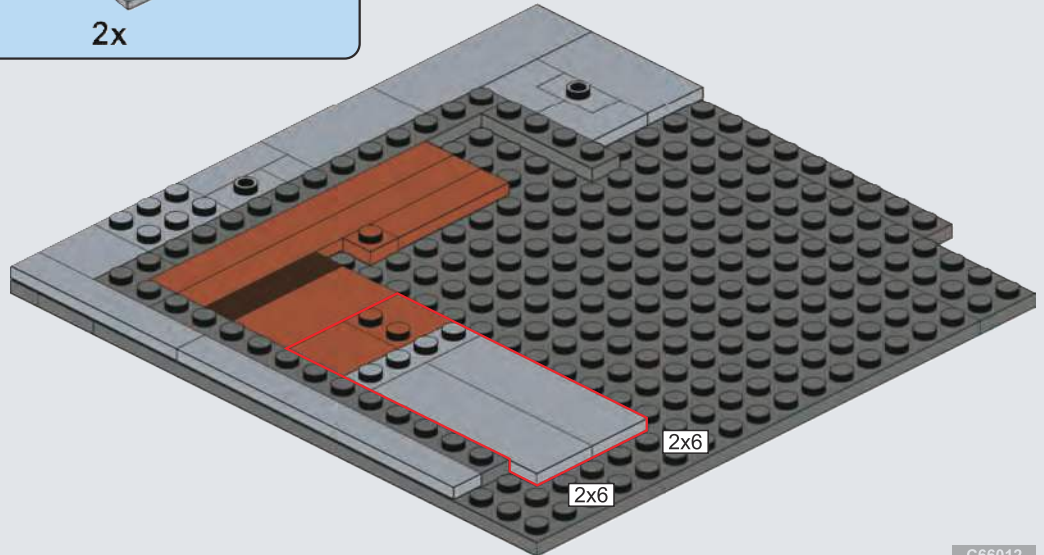

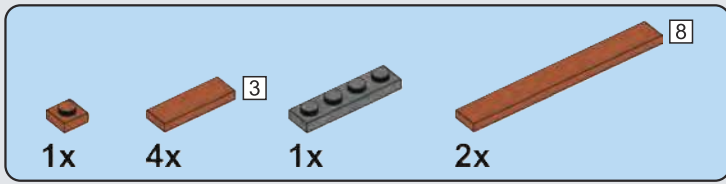

# A11

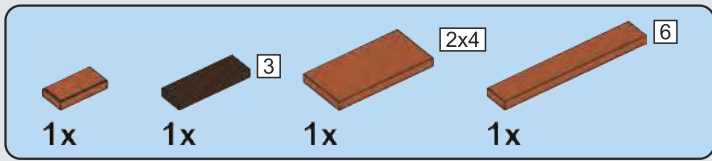
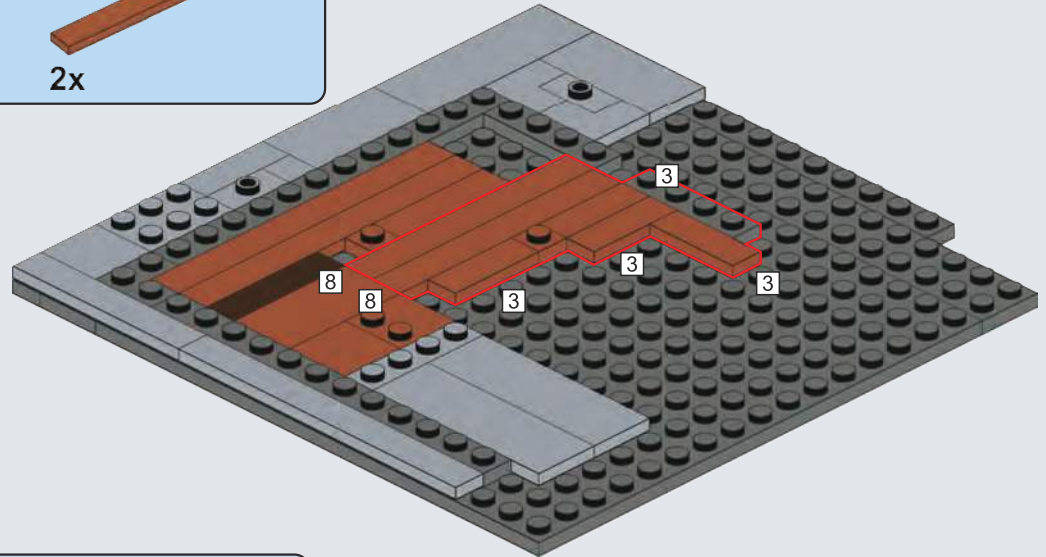

# A12

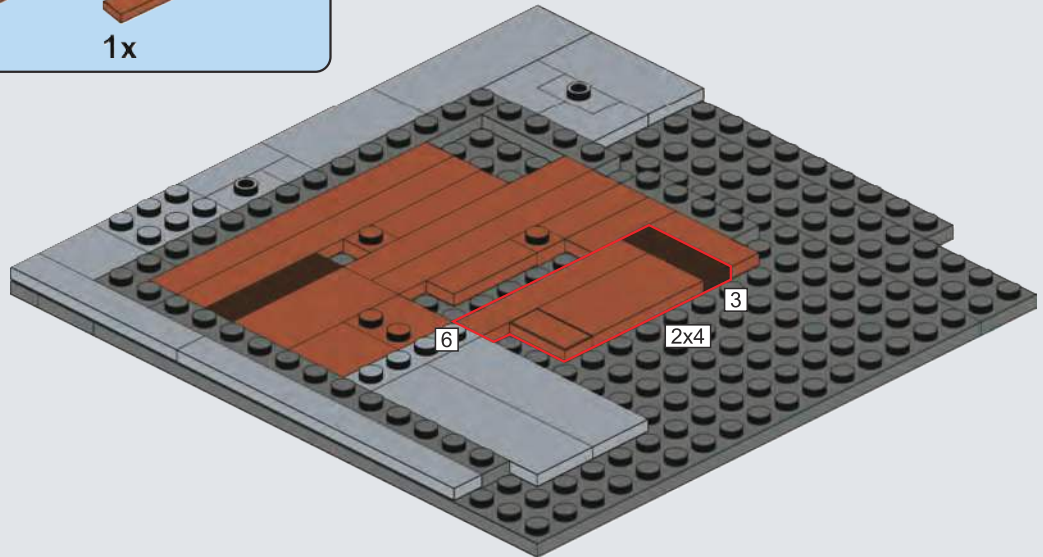



# A13

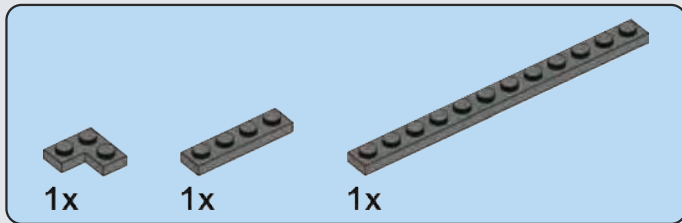
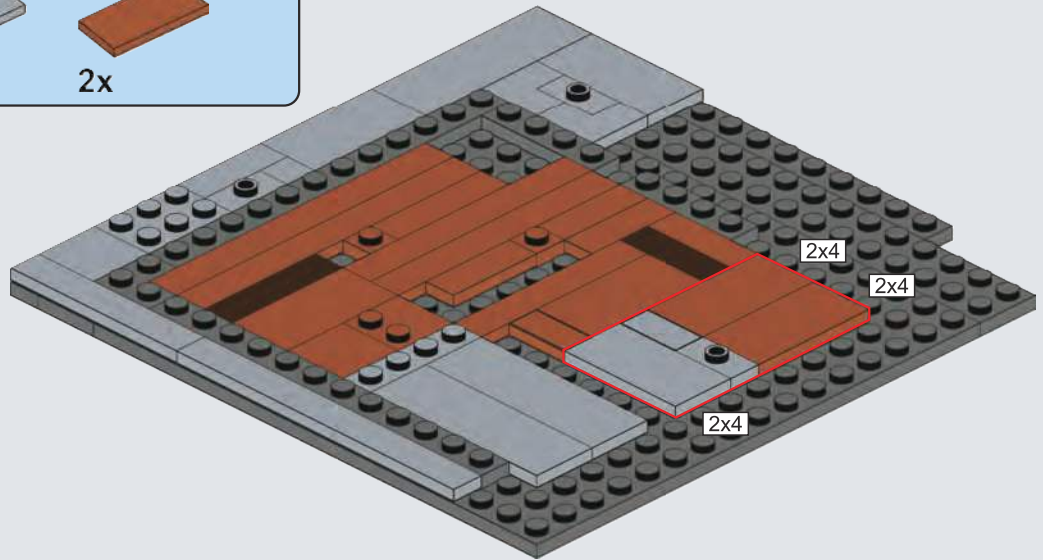

# A14

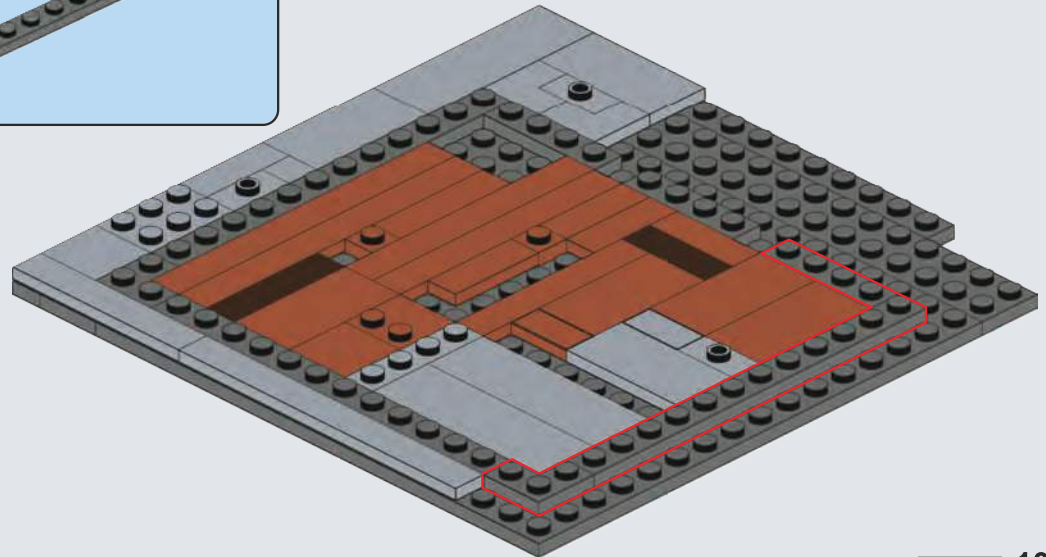

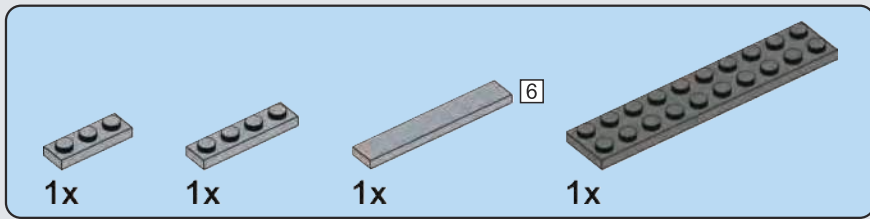

# A15

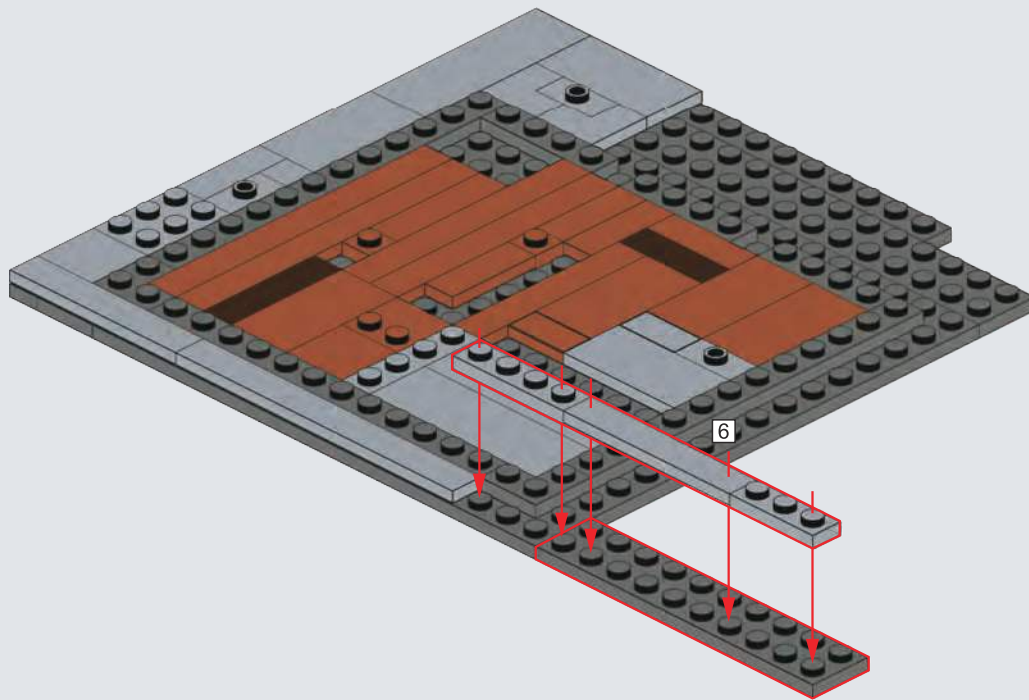

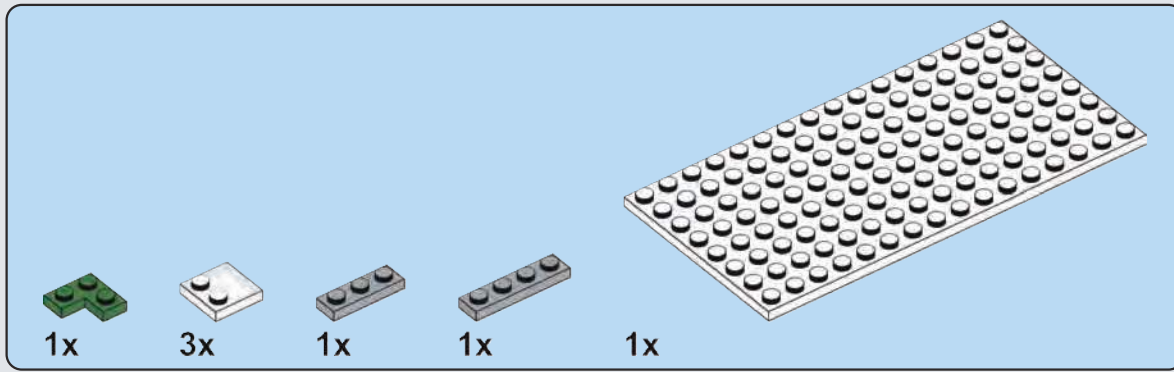

# A16

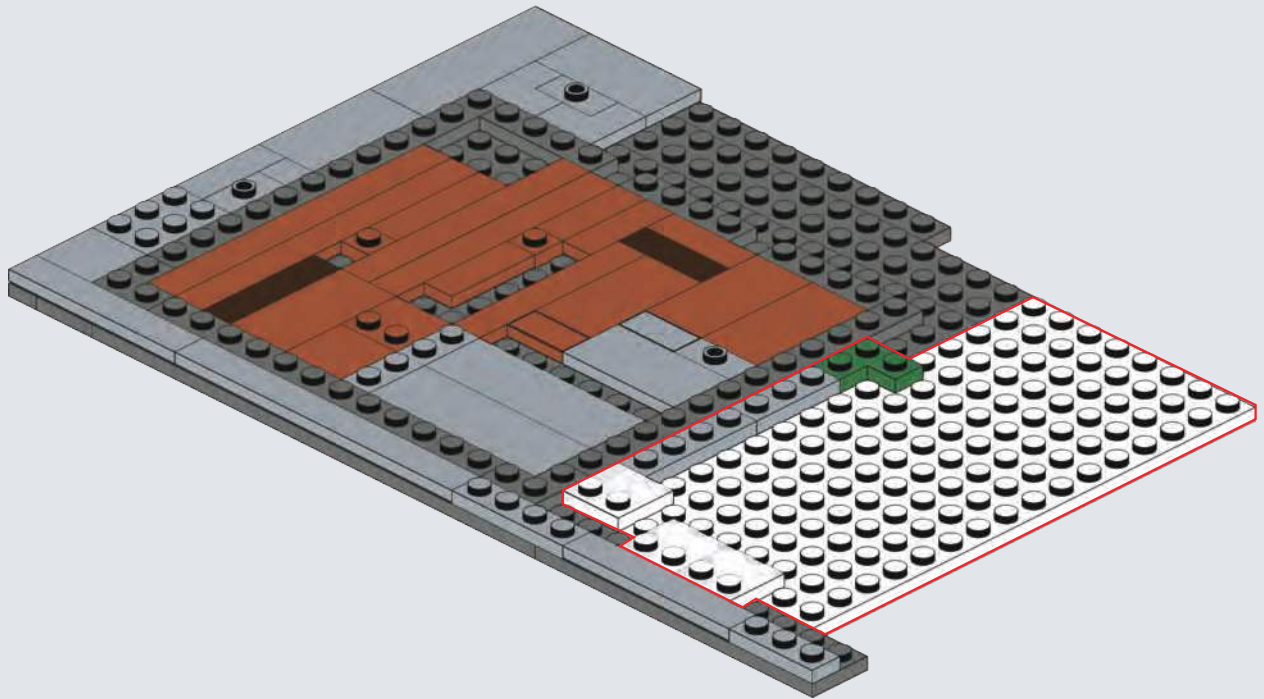

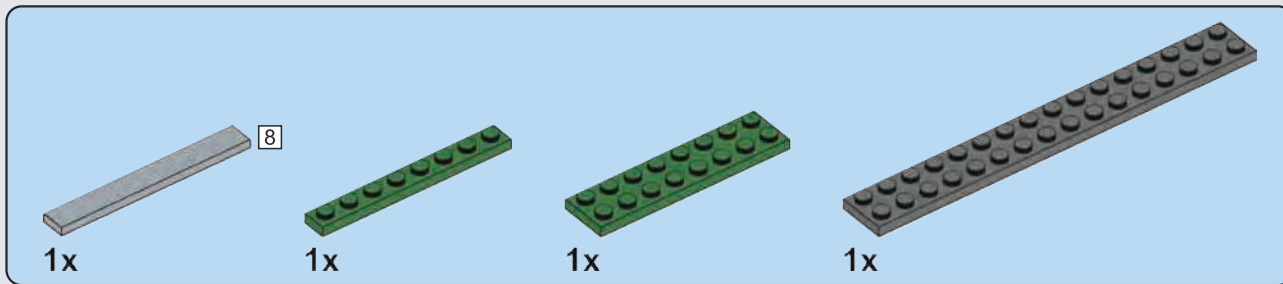

# A17

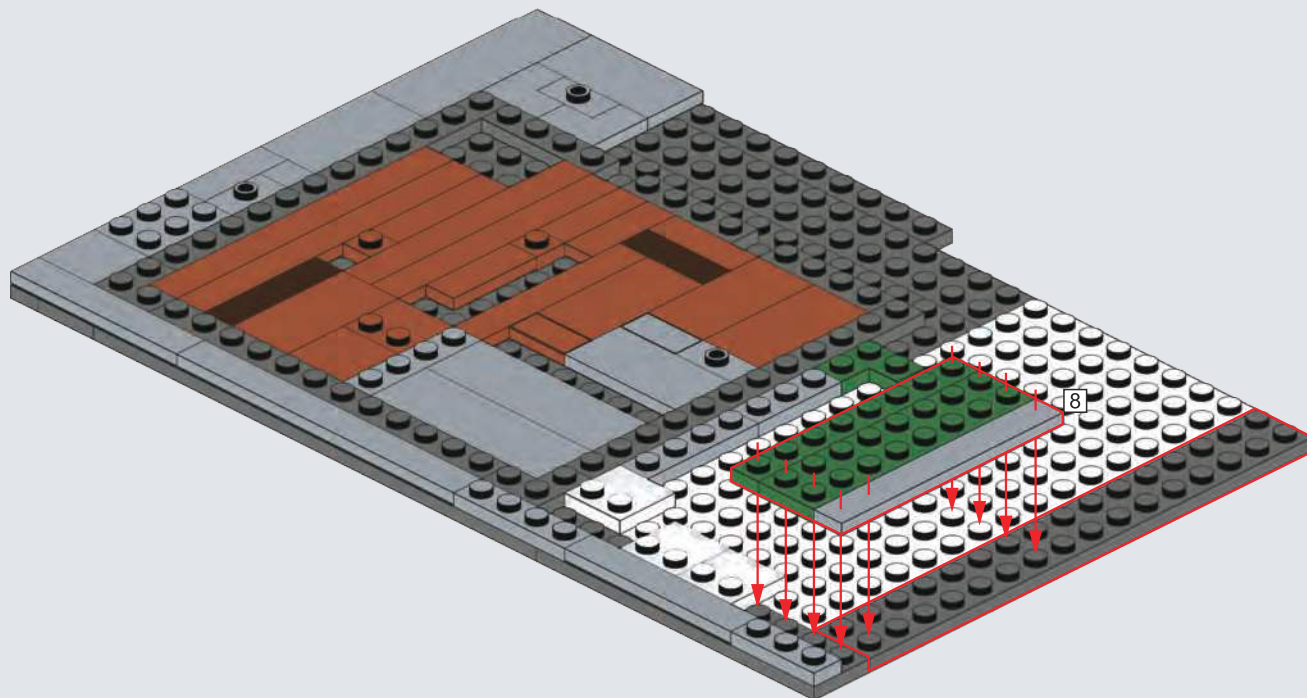

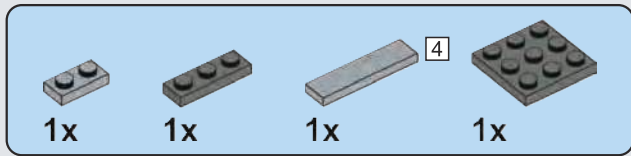

# A18

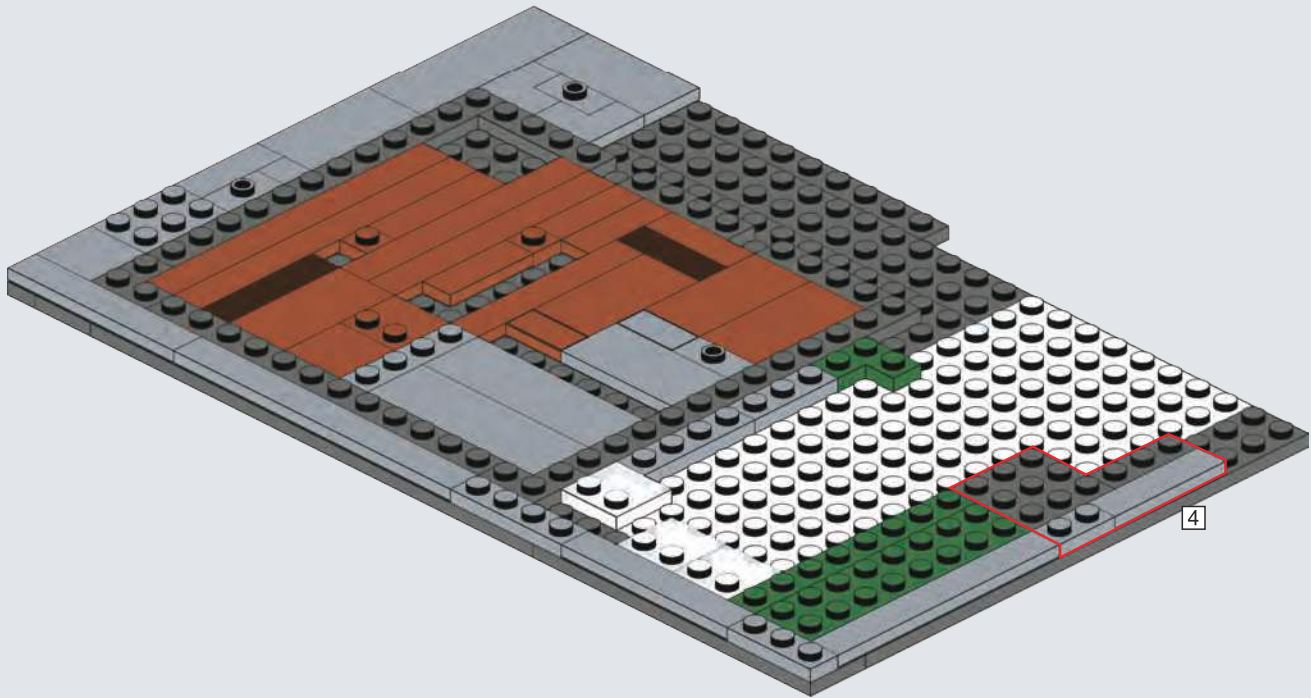

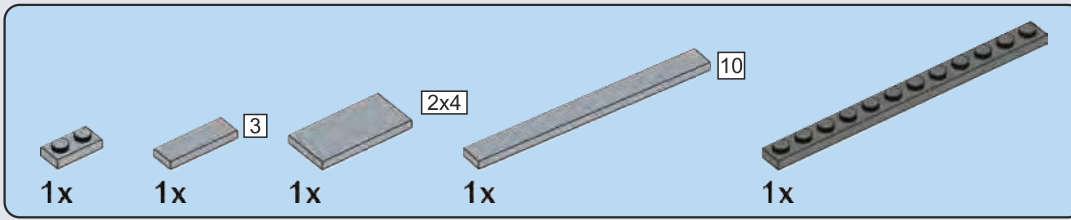

# A19

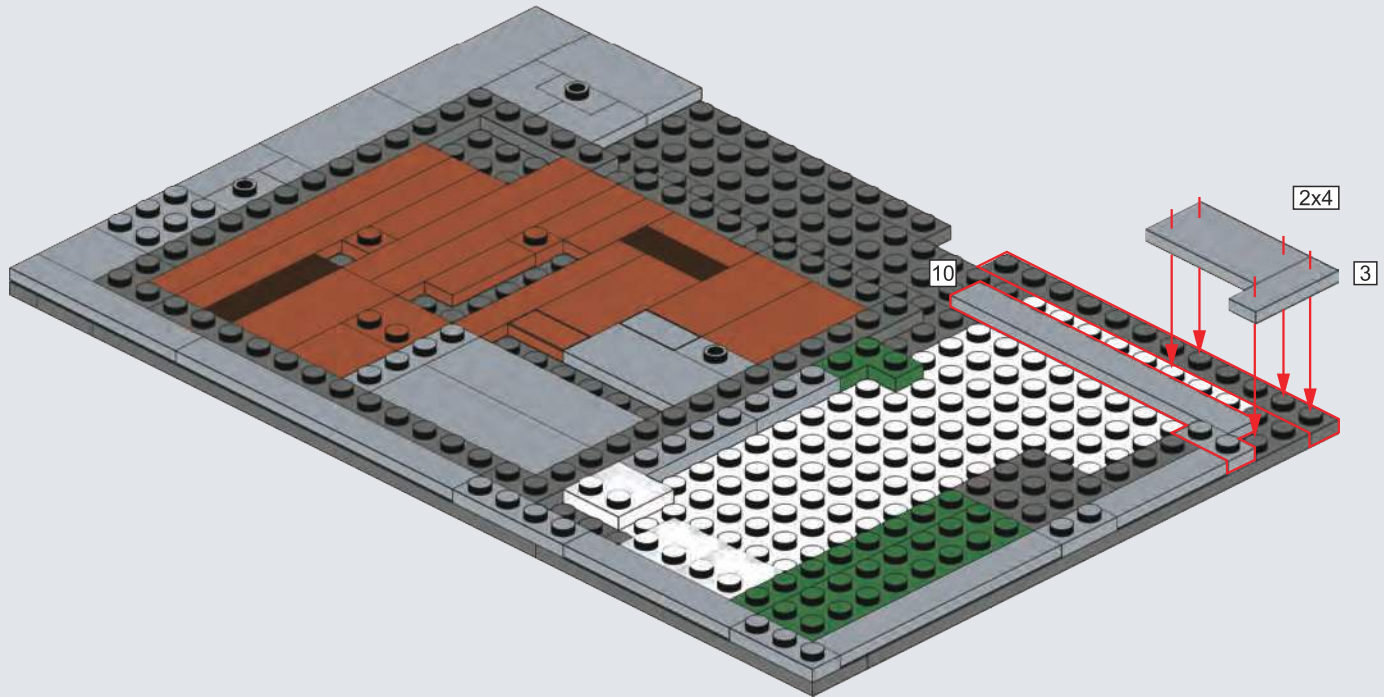

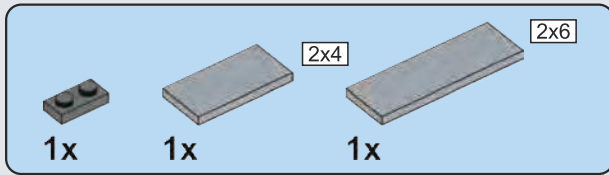

# A20

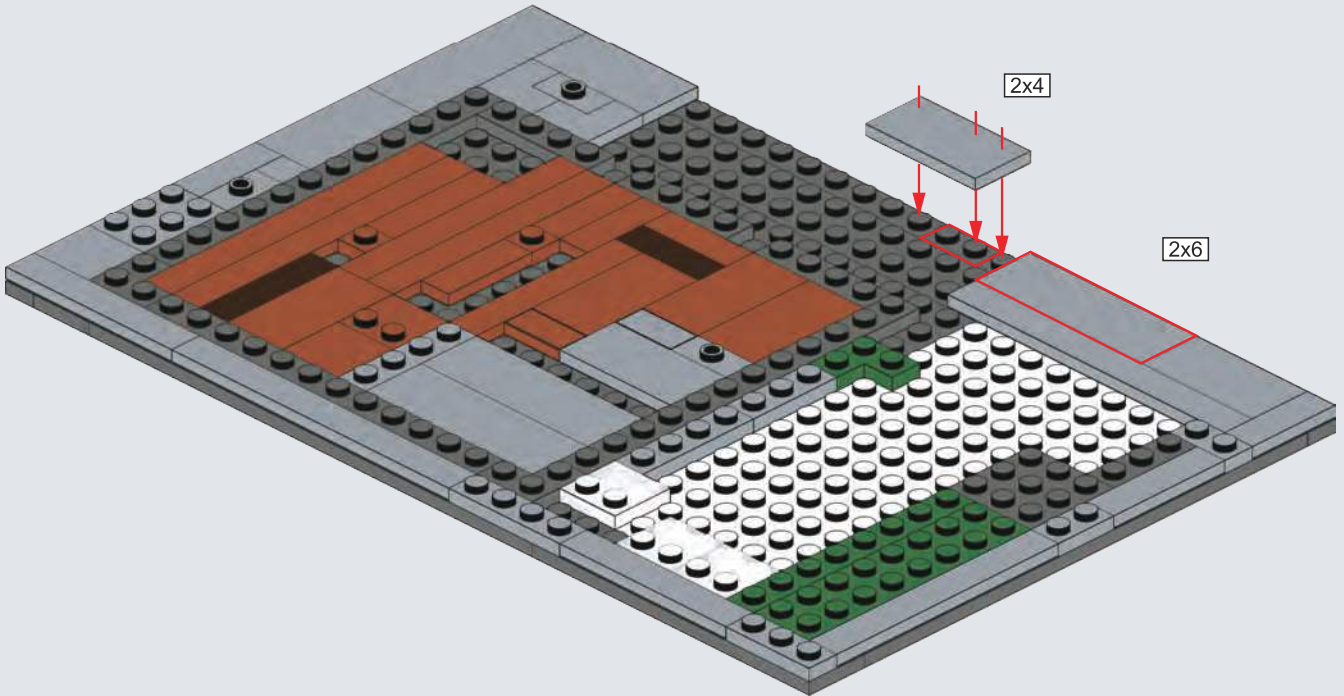



# A21

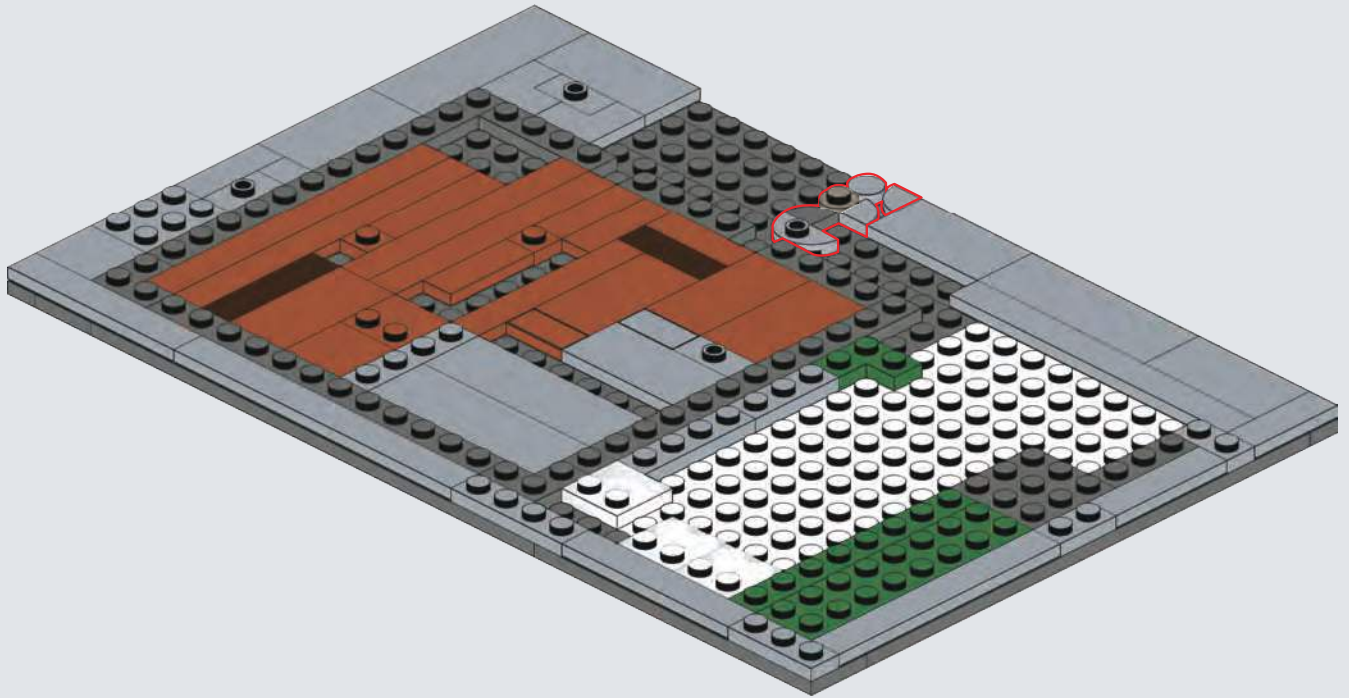



# A22

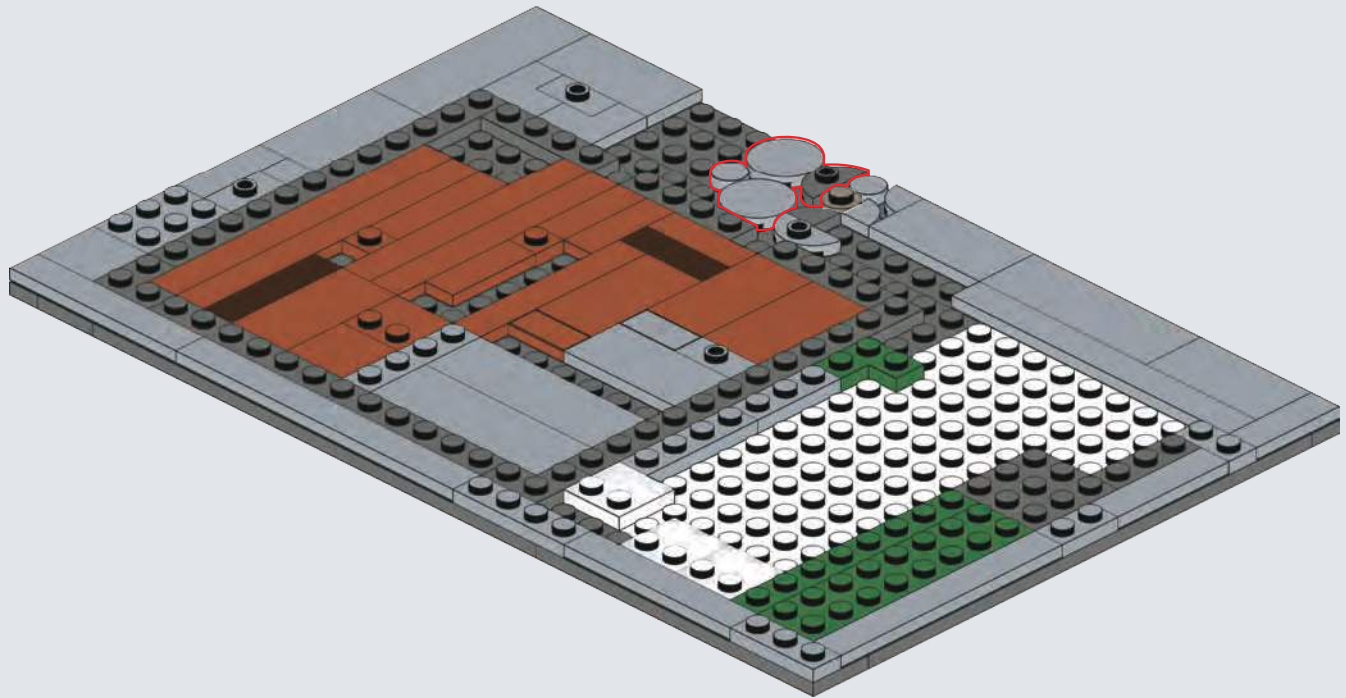

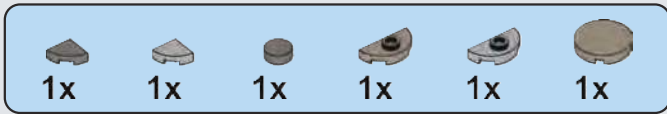

# A23

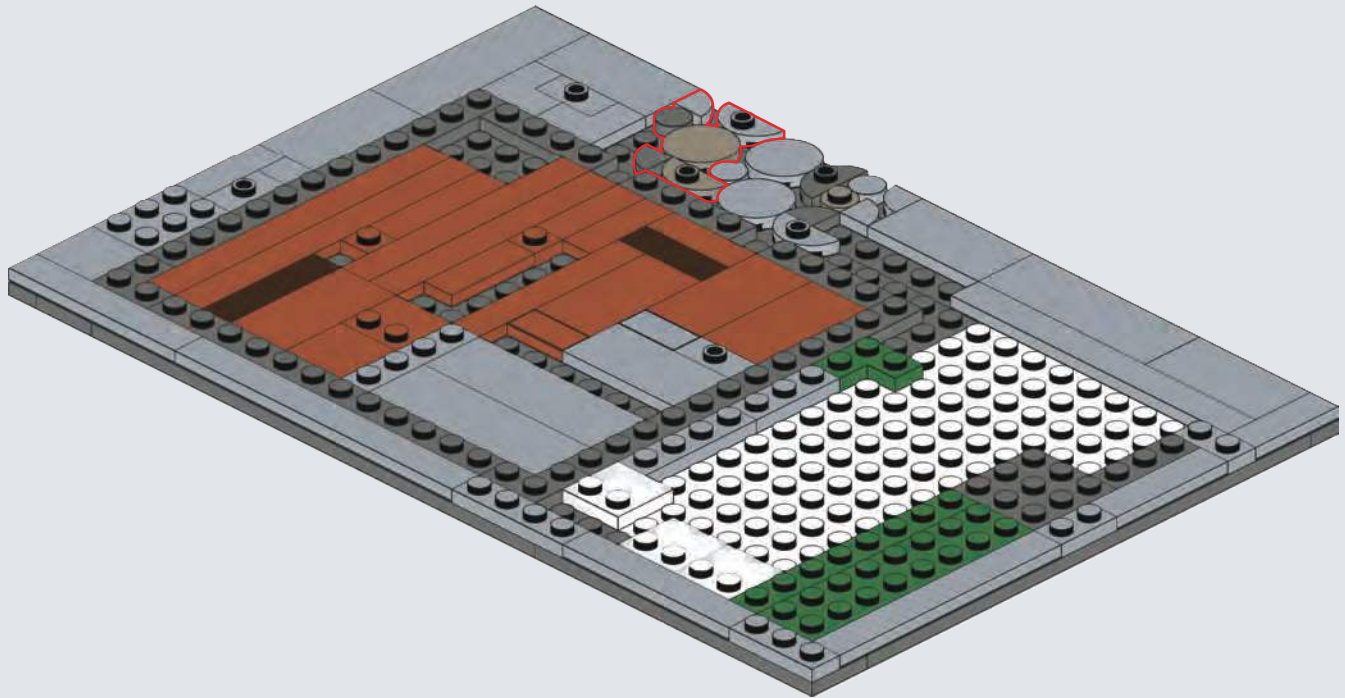

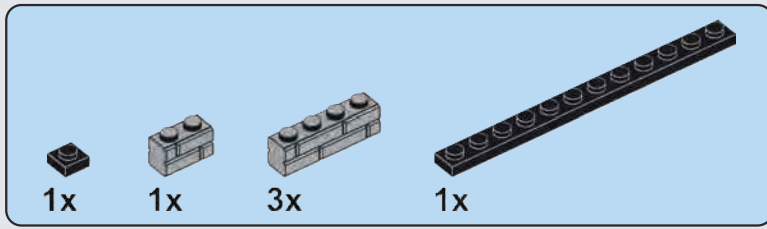

# A24

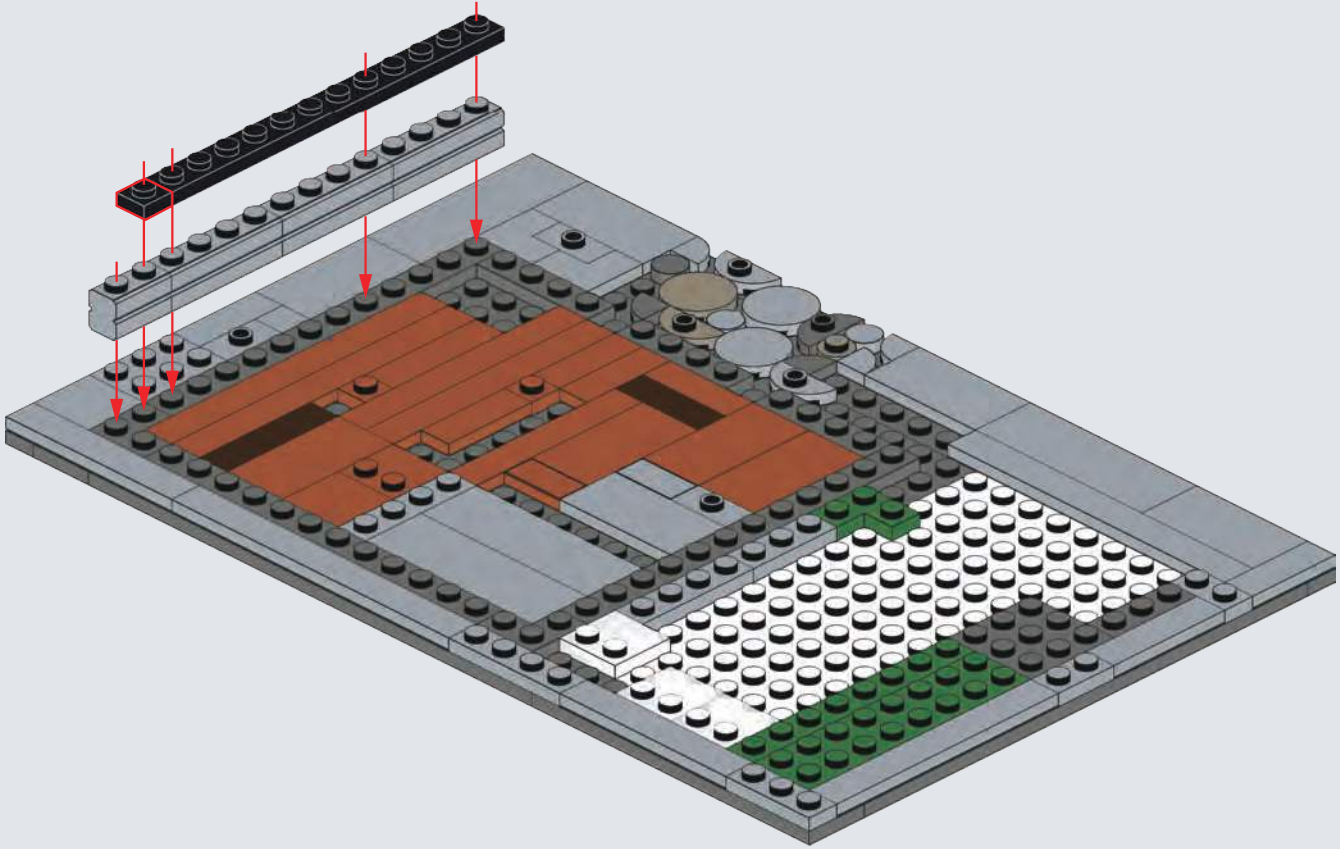

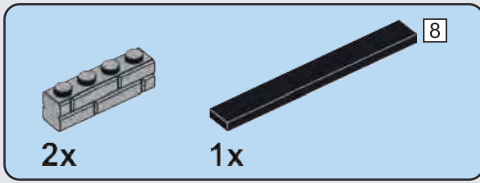

# A25

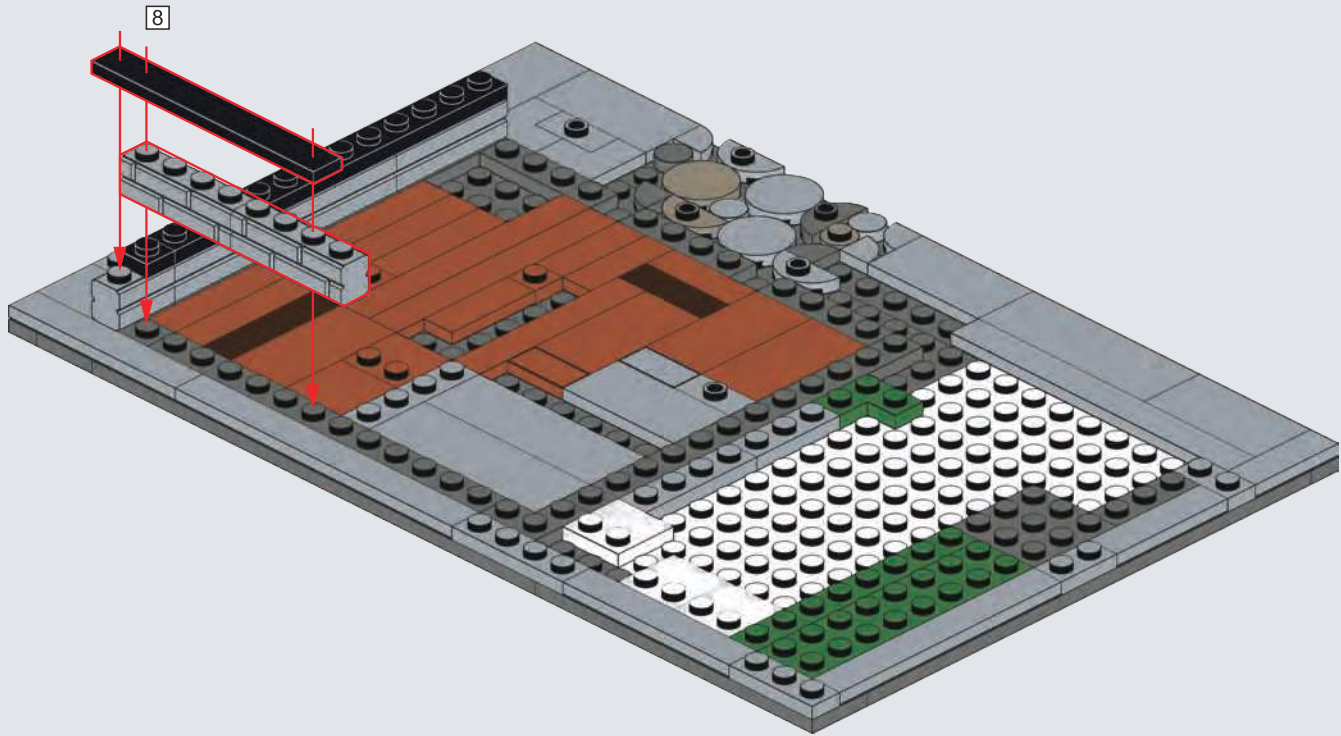

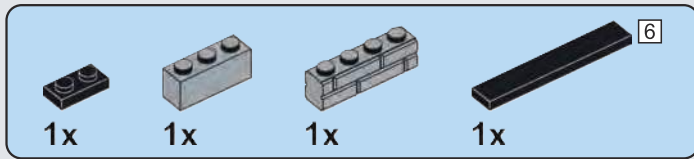

# A26

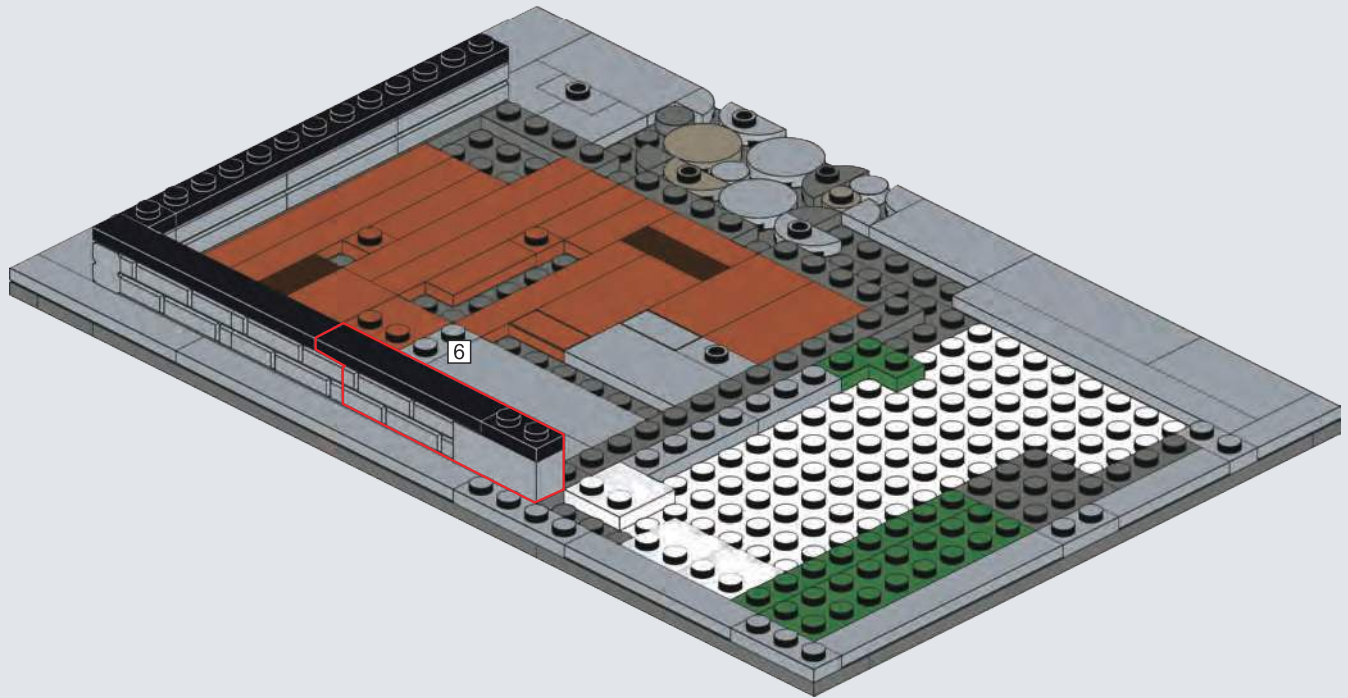

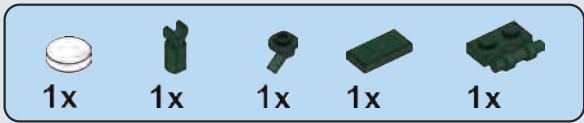

# A27

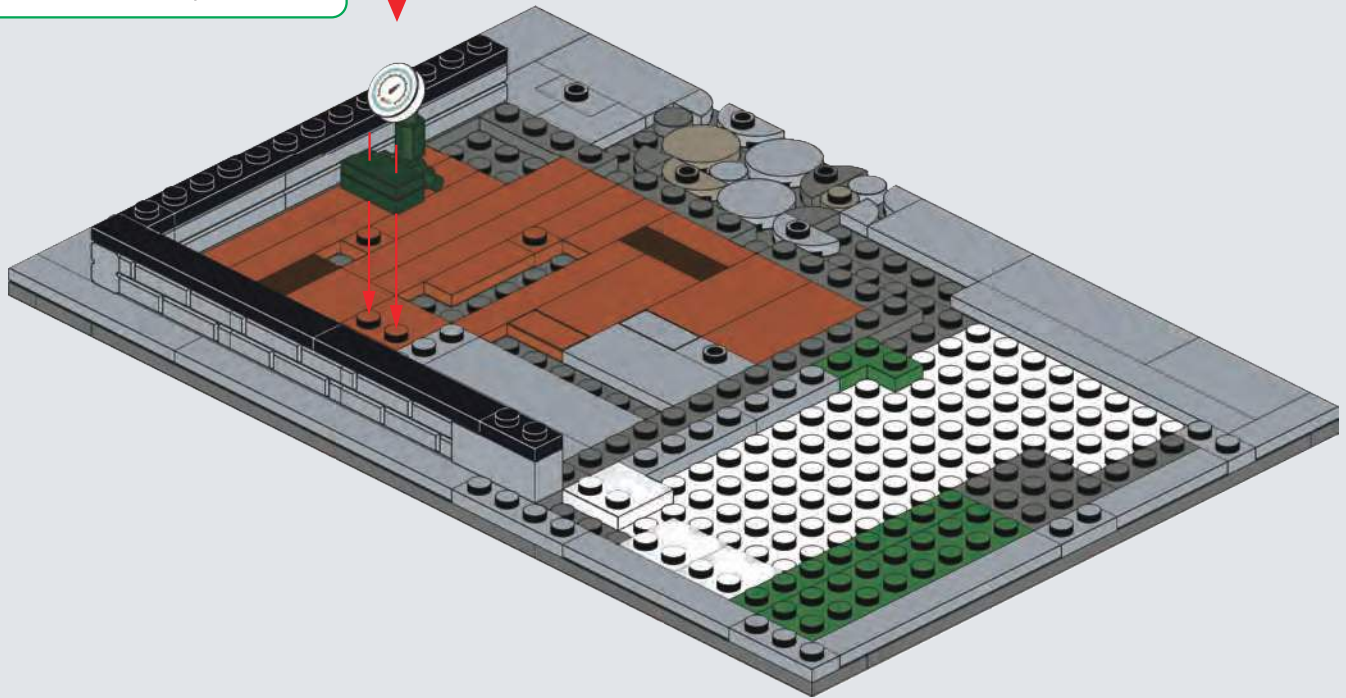
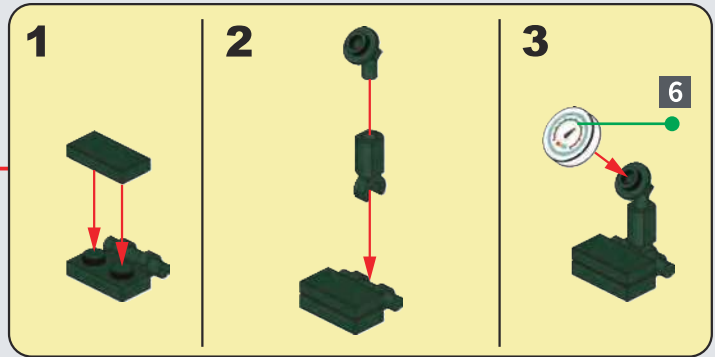
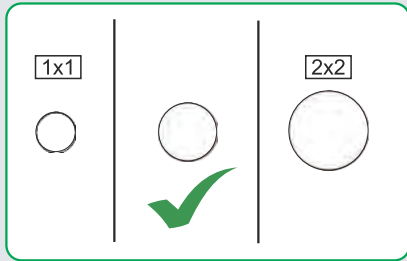

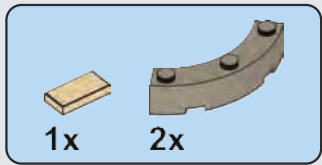

# A28

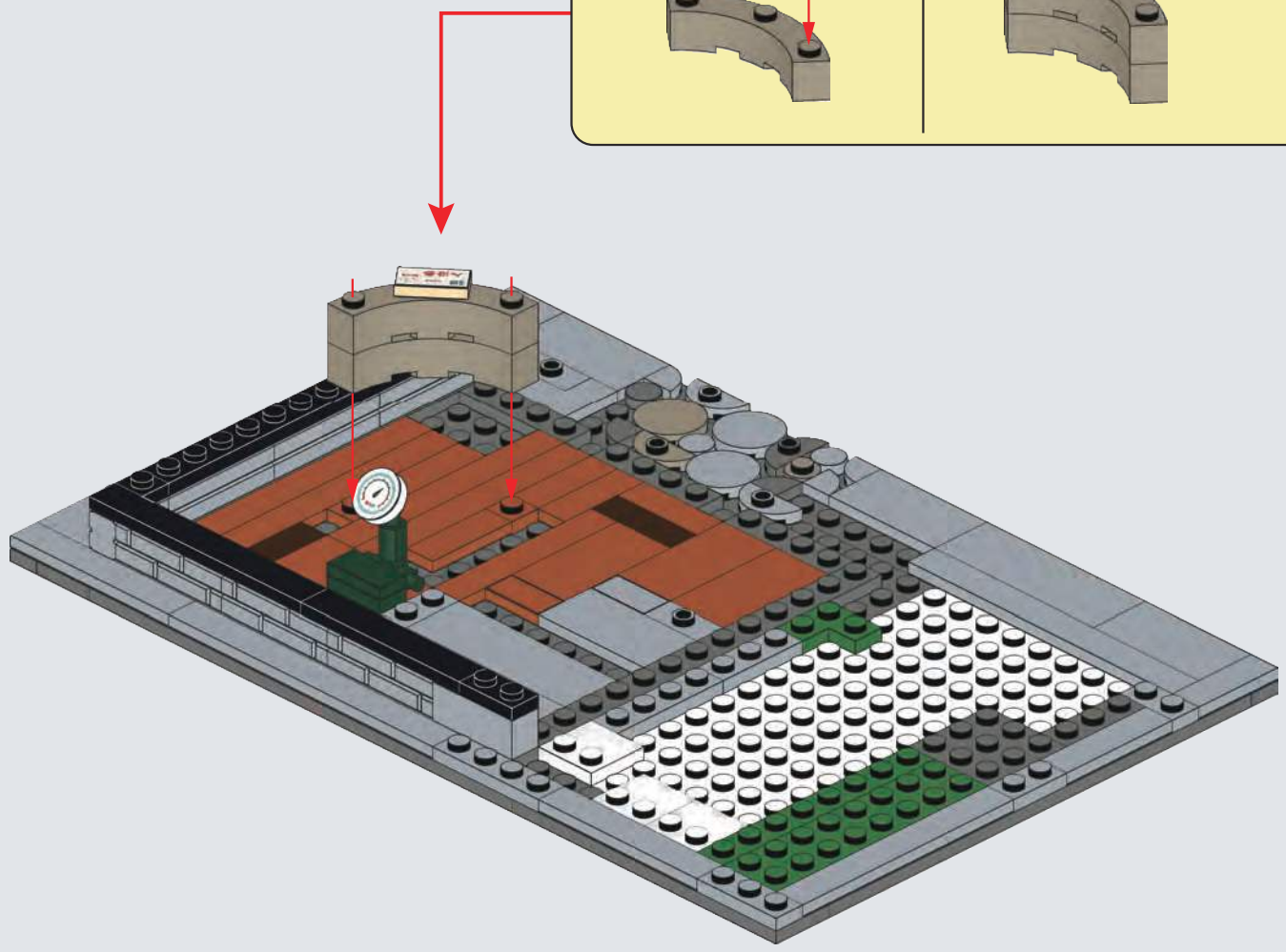
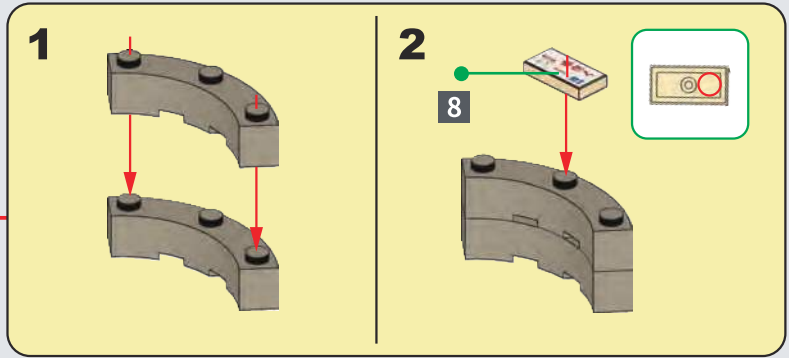

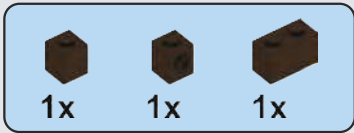

## A29

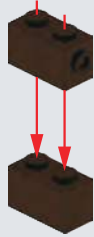

## A30

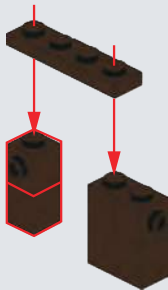

## A31

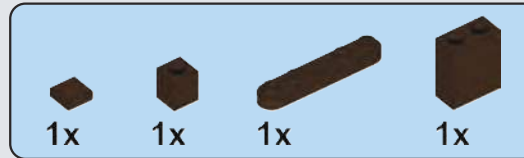

## A32

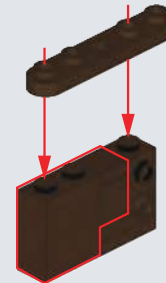

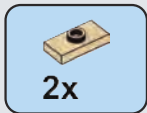

**A33**

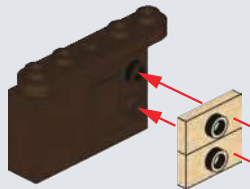

**A34**

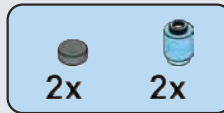
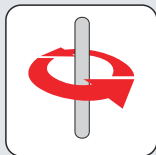
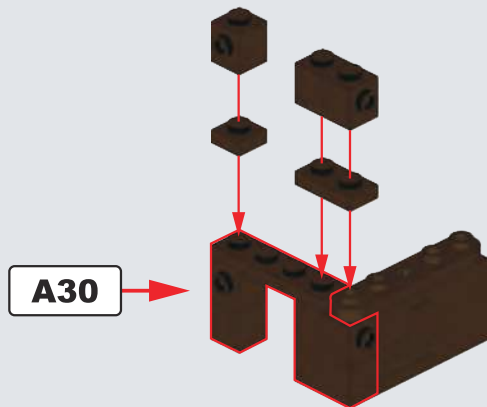

**A35**

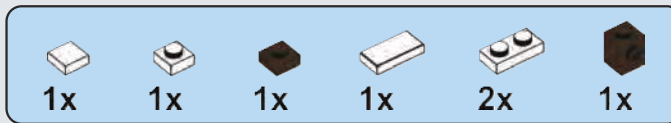
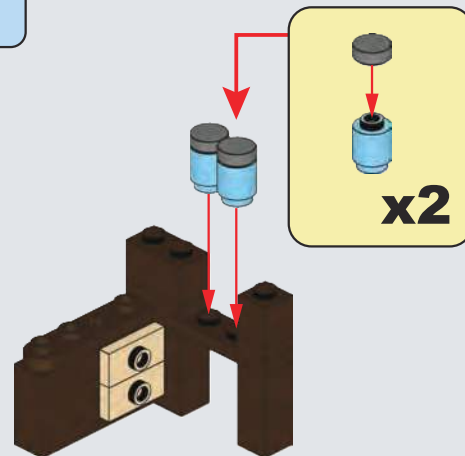

**A36**

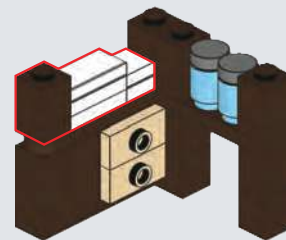



**A37**

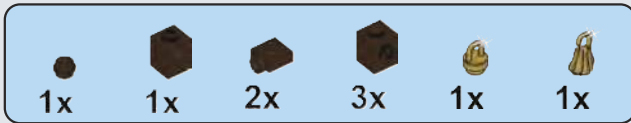
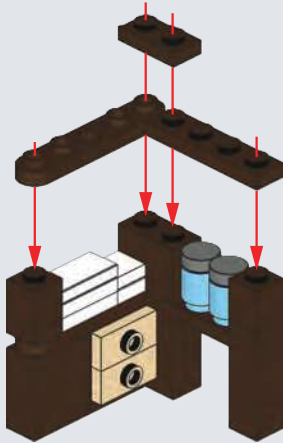

**A38**

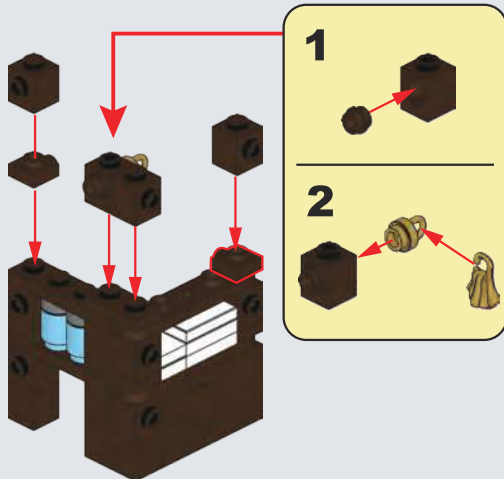

**A39**

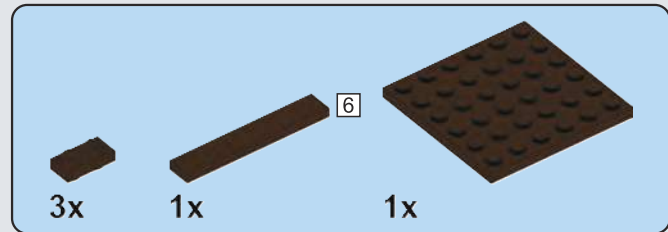
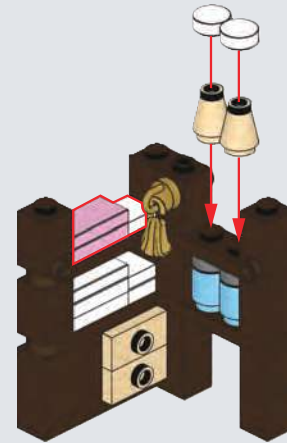
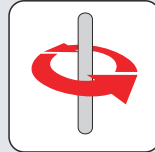

**A40**

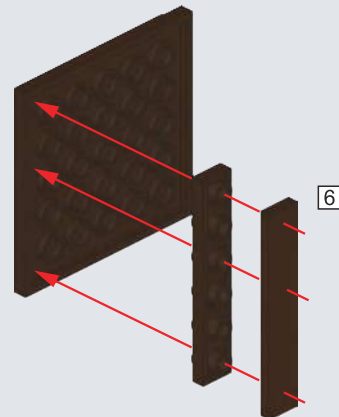

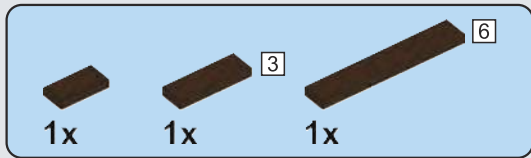

## A41

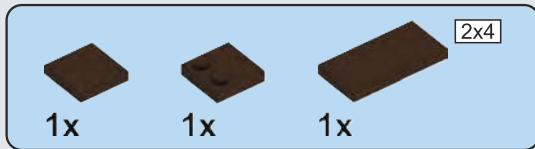
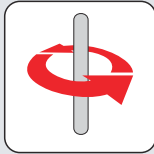
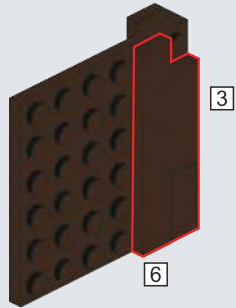

## A42

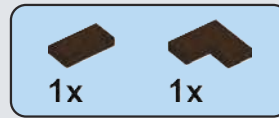
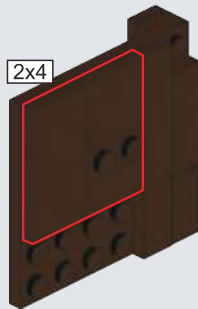

## A43

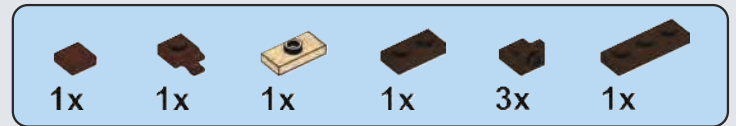
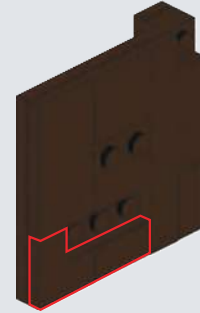

## A44

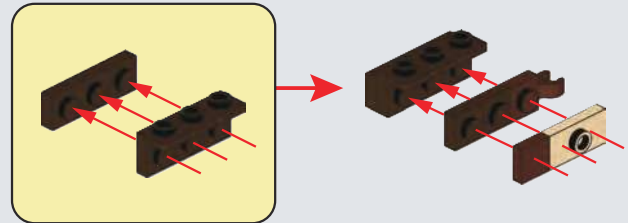

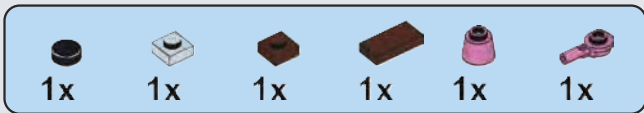

## A45

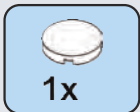
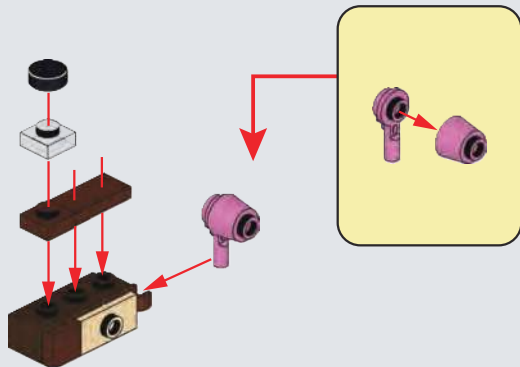

## A46

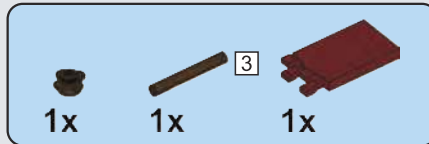
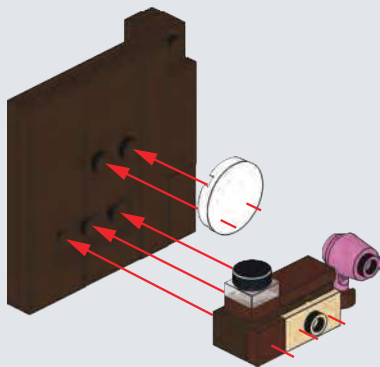

## A47

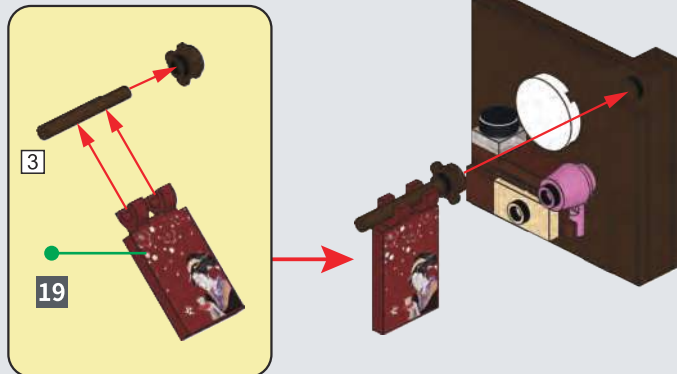
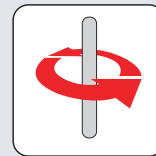

## A48

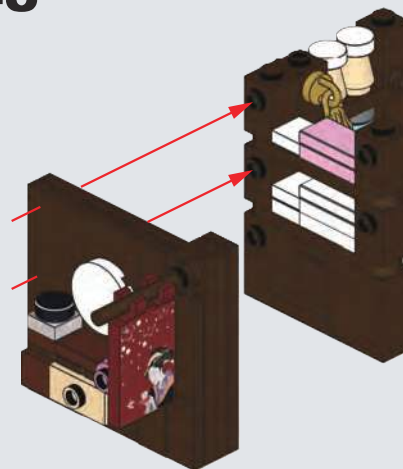

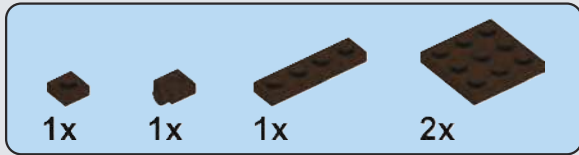

**A49**

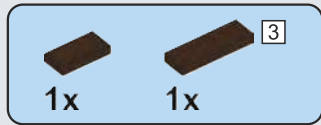
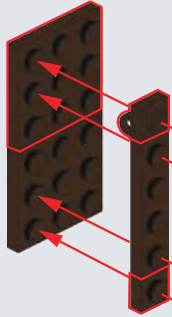

**A50**



**A51**

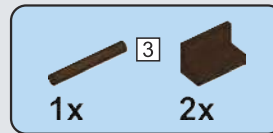

**A52**

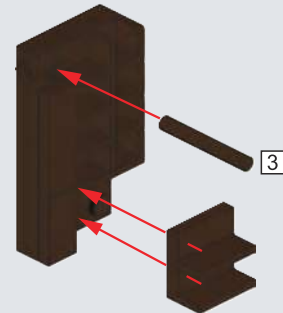

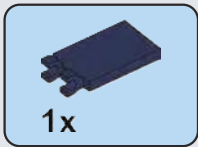

**A53**

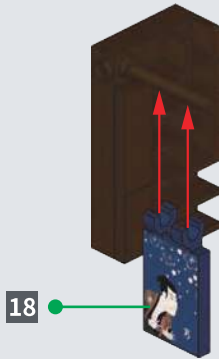

18

**A54**

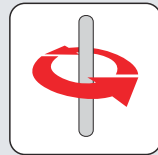
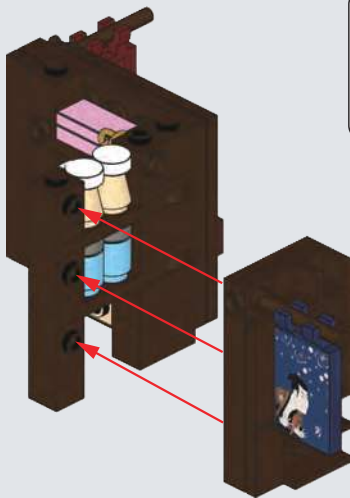

**A55**

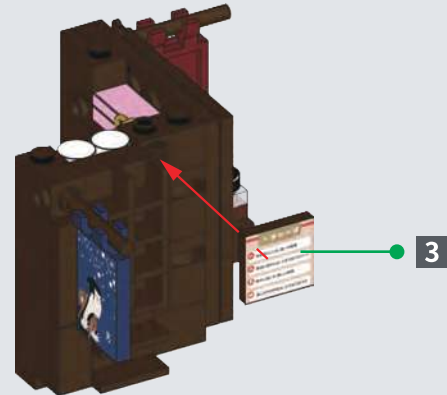

3

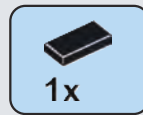

**A56**

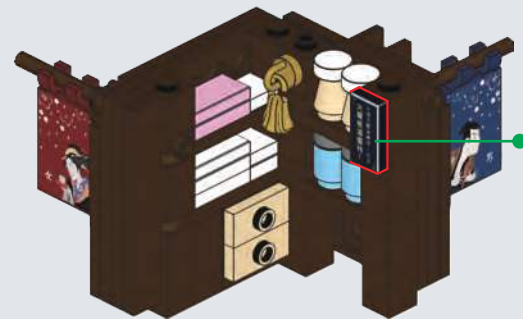
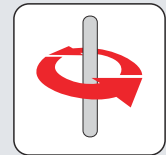

20

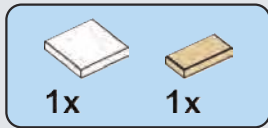

**A57**

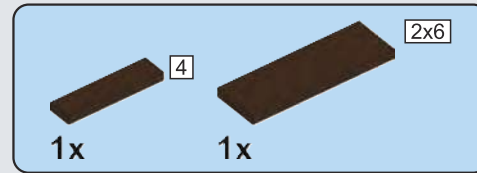

**A58**

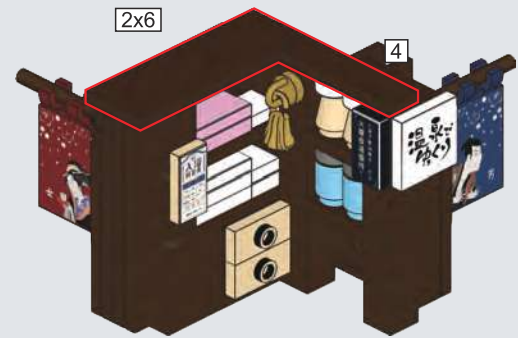

# A59

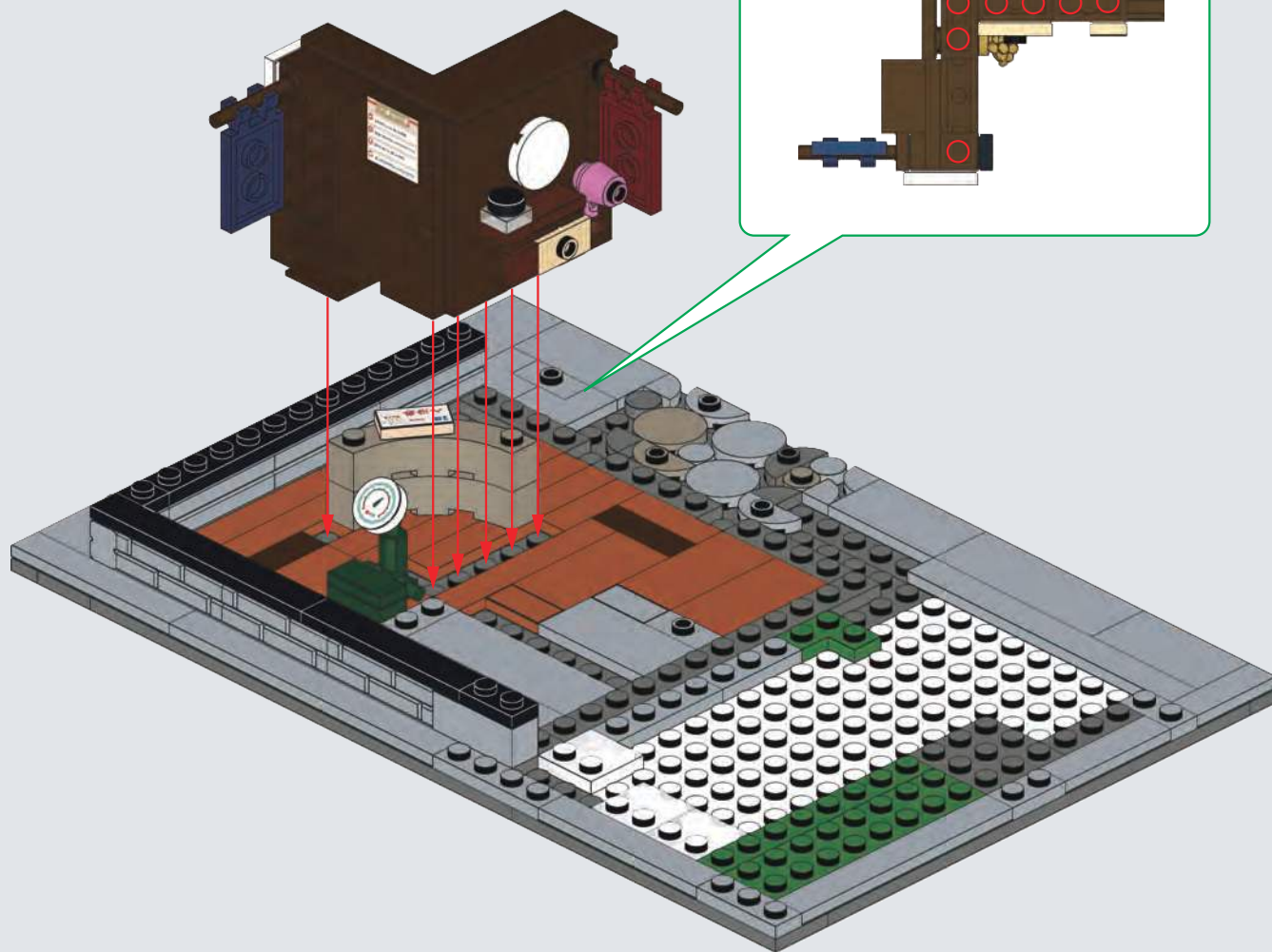

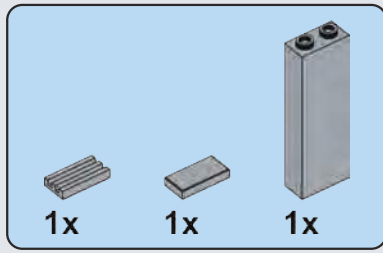

## A60

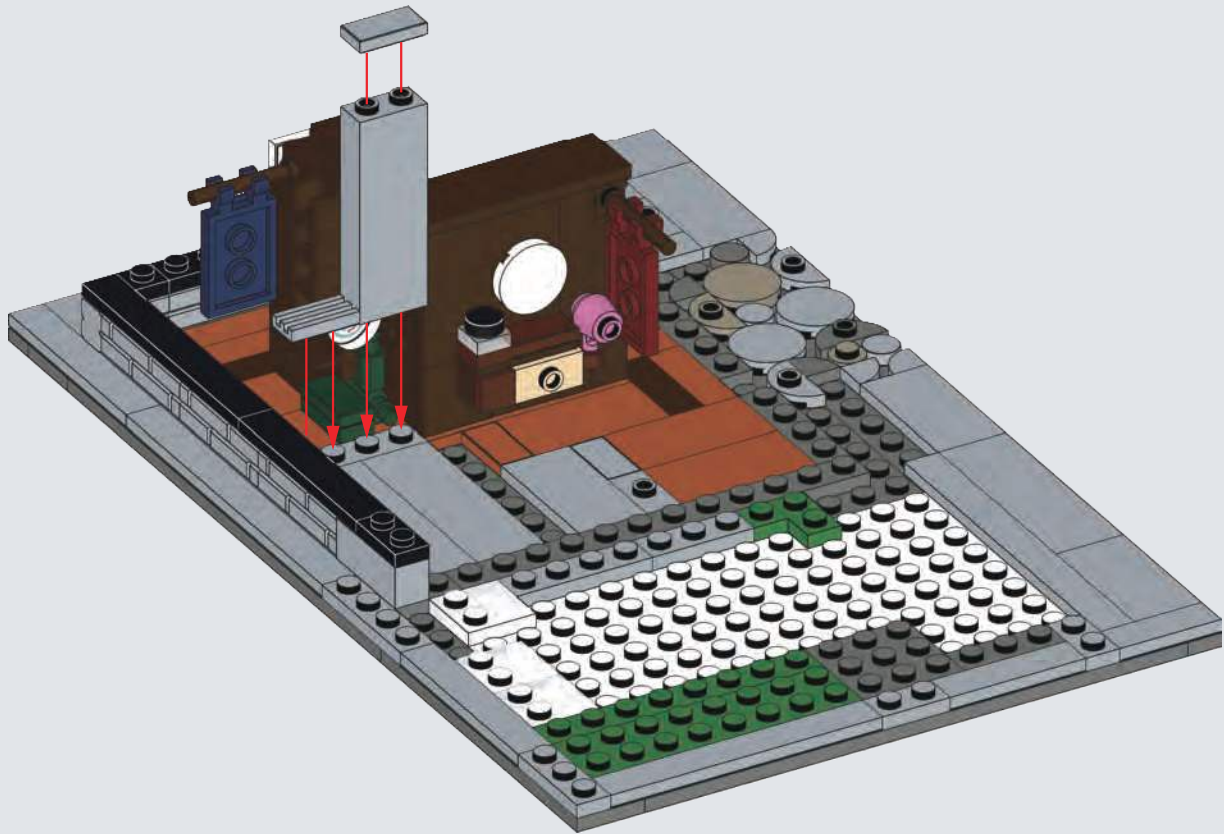

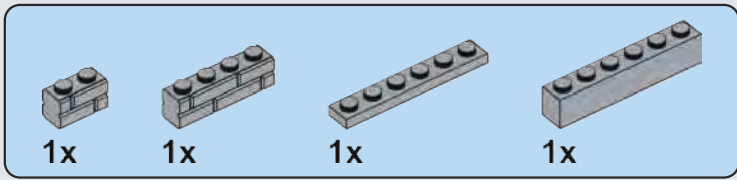

# A61

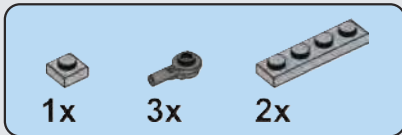
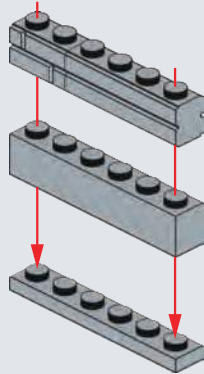

# A62

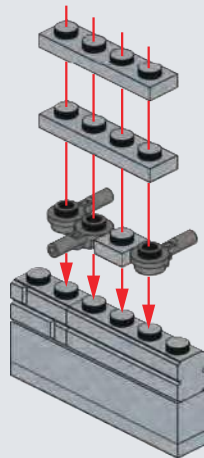

# A63

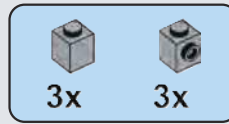
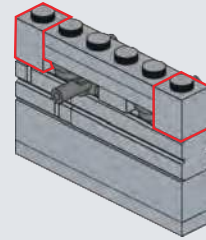

# A64

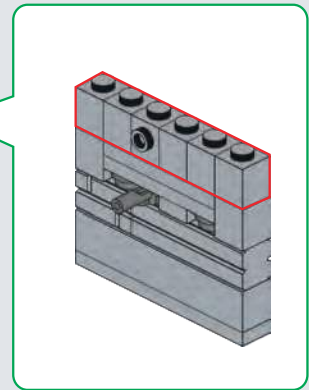
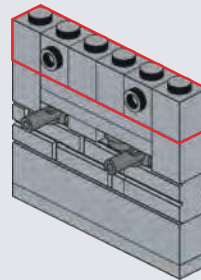

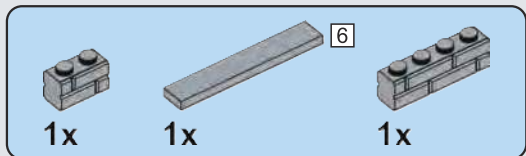

## A65

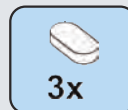
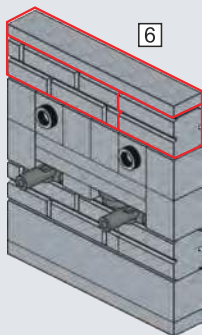

## A66

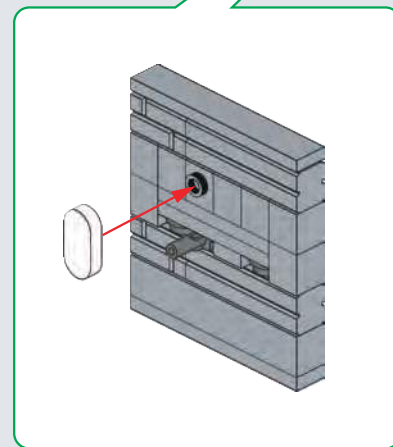
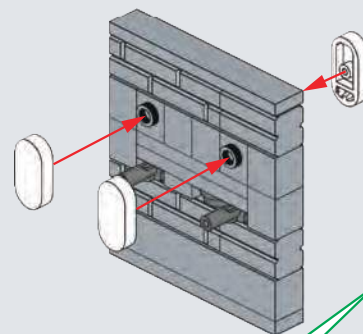

# A67

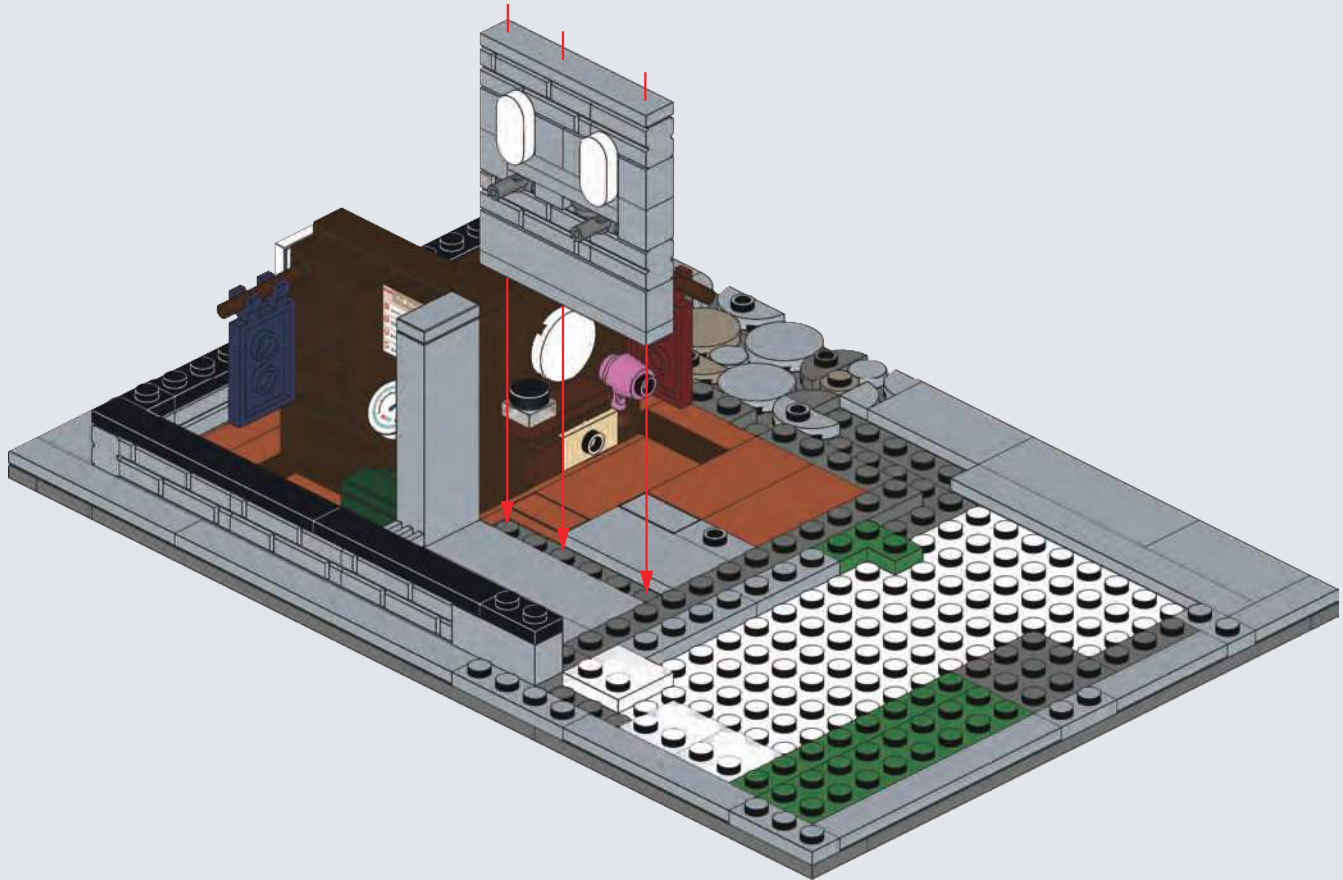
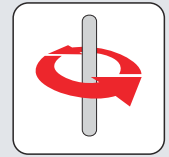

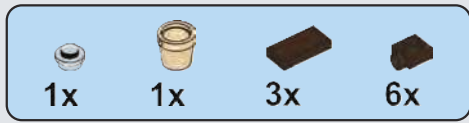

# A68

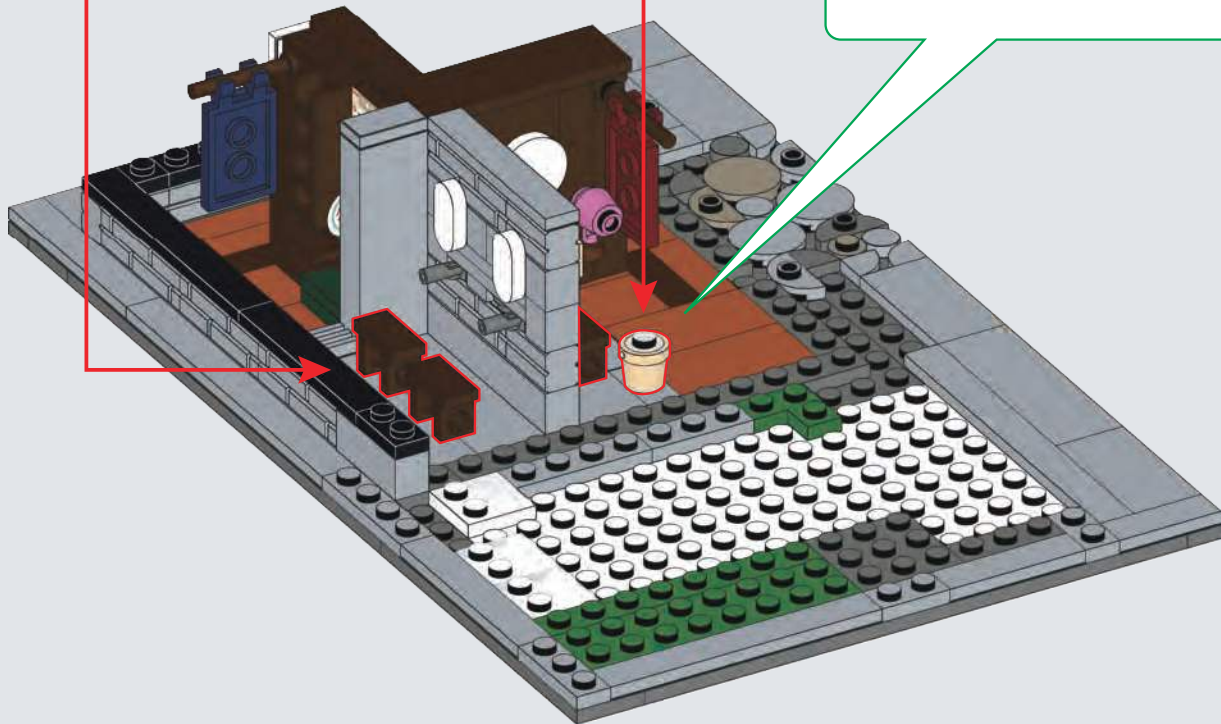
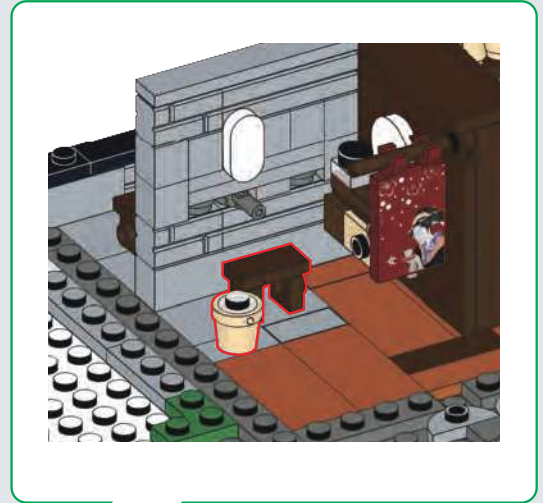
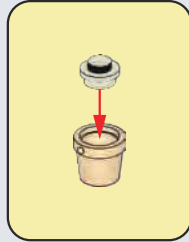
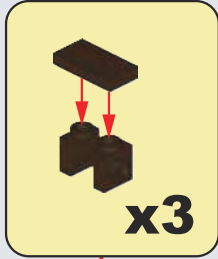
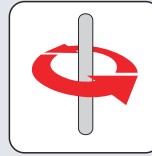

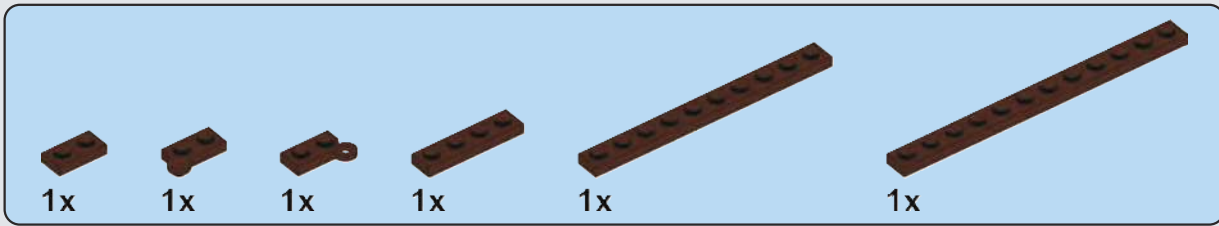

## A69

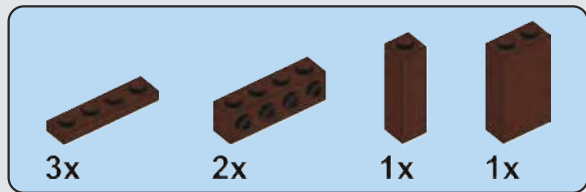
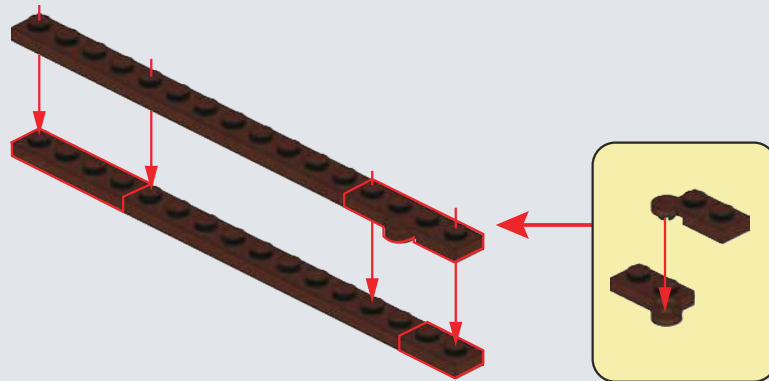

## A70

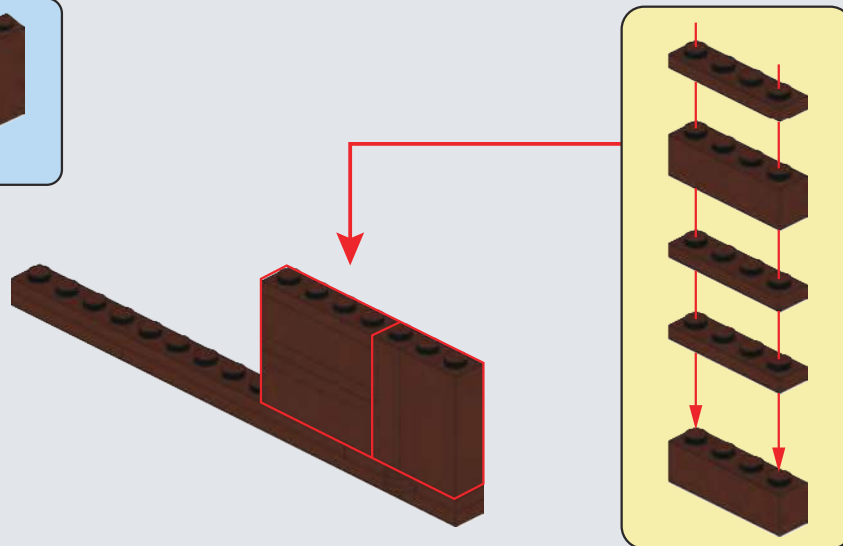

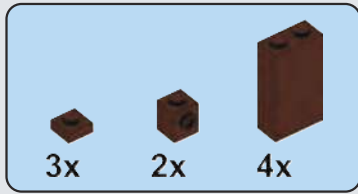

**A71**

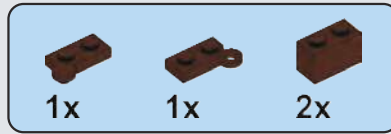
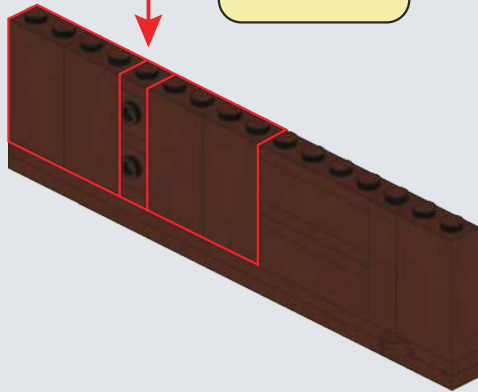
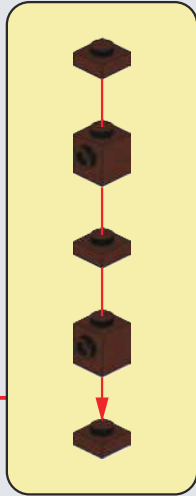

**A72**

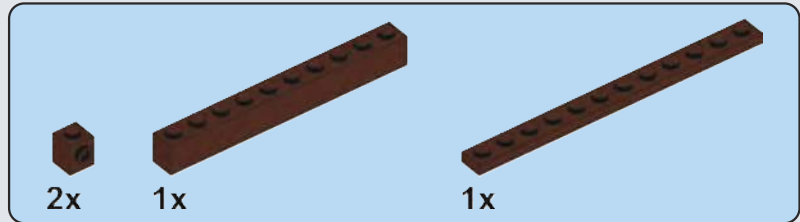
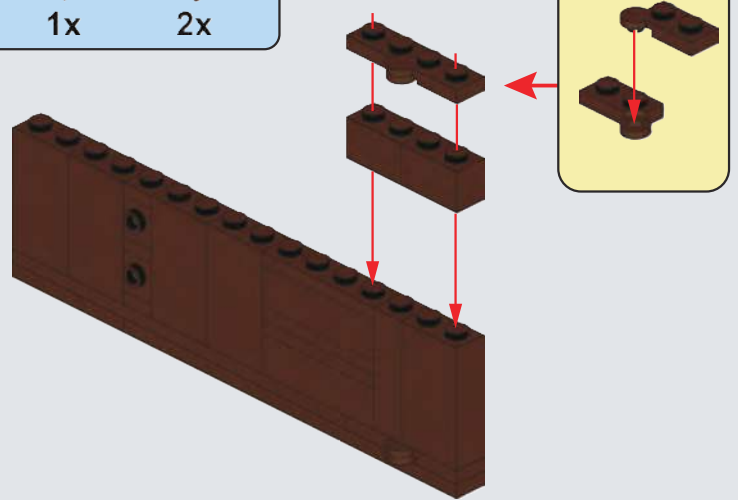

**A73**

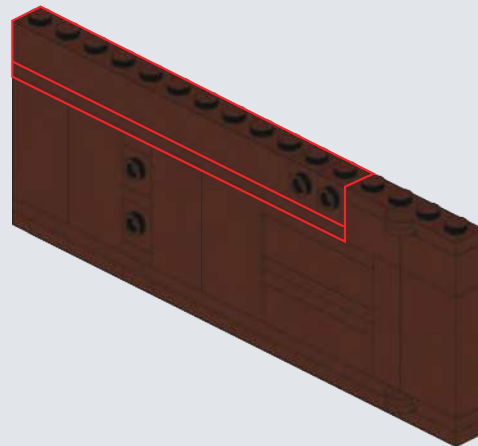

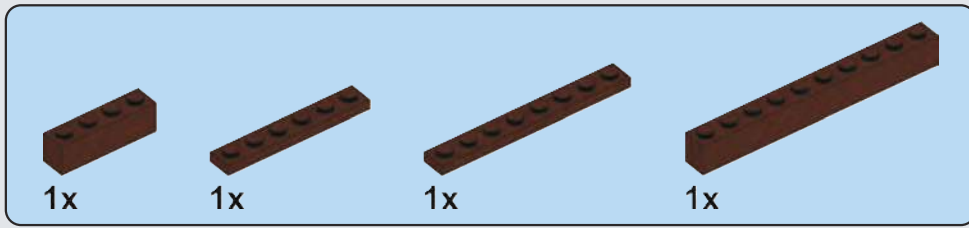

## A74

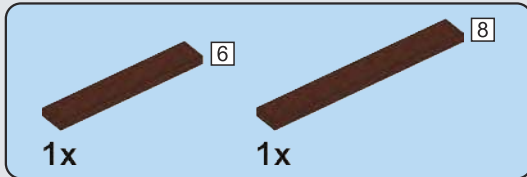
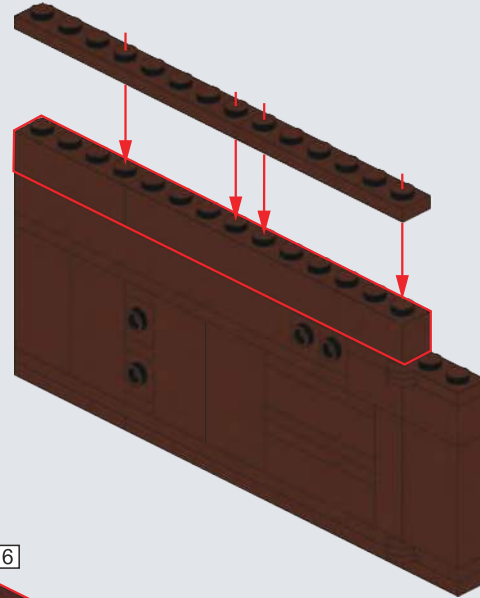

## A75

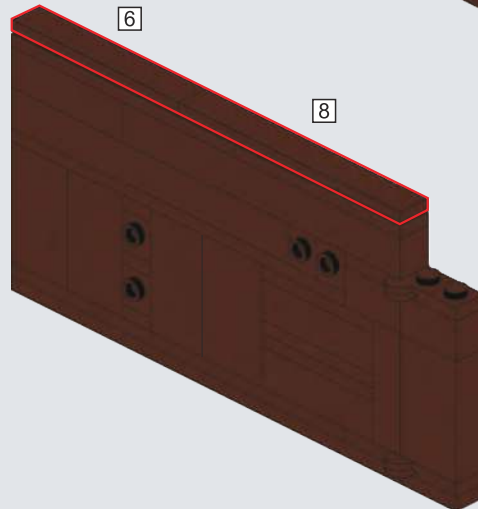



2x

# A76

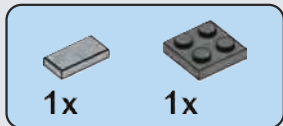
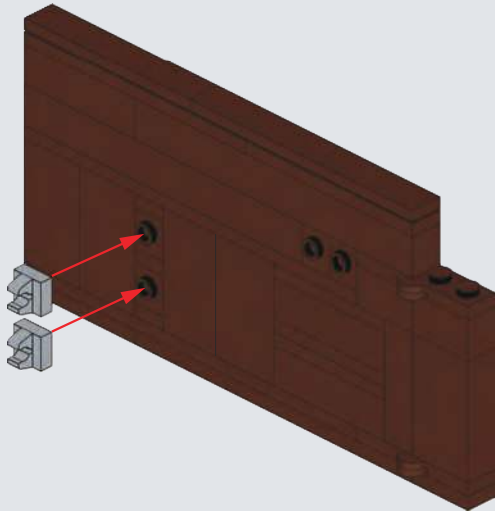

1x

1x

# A77

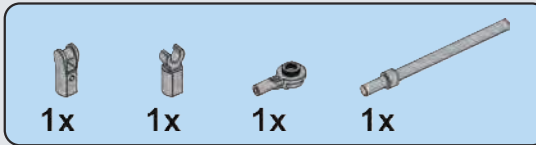
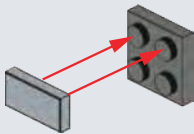

1x

1x

1x

1x

# A78

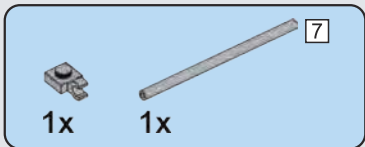
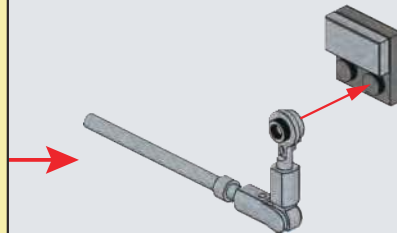
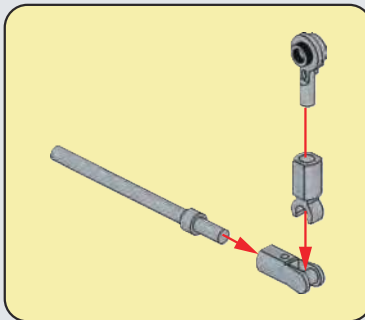

1x

1x

# A79

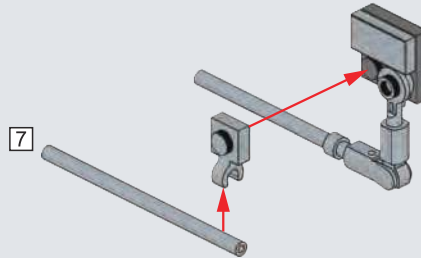

# A80

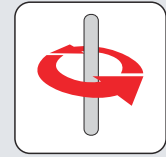
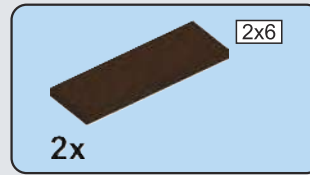
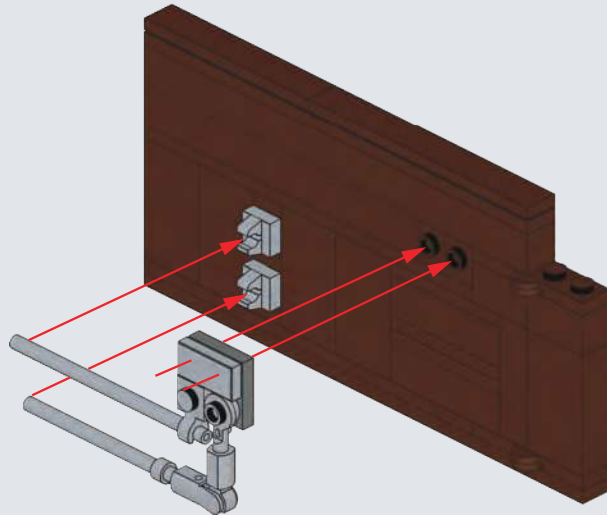

# A81

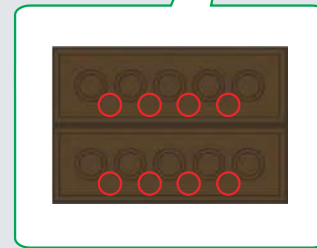
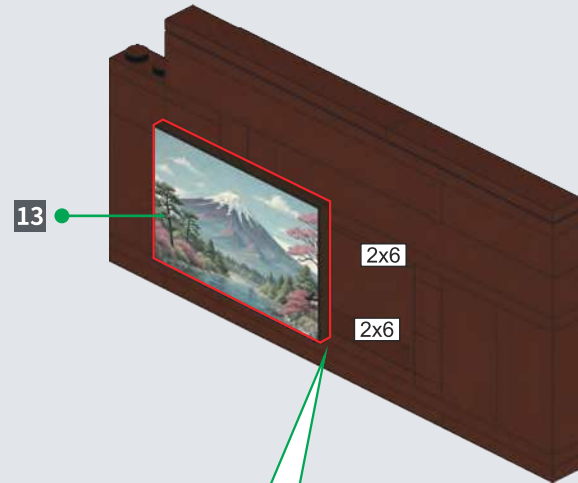

**A82**

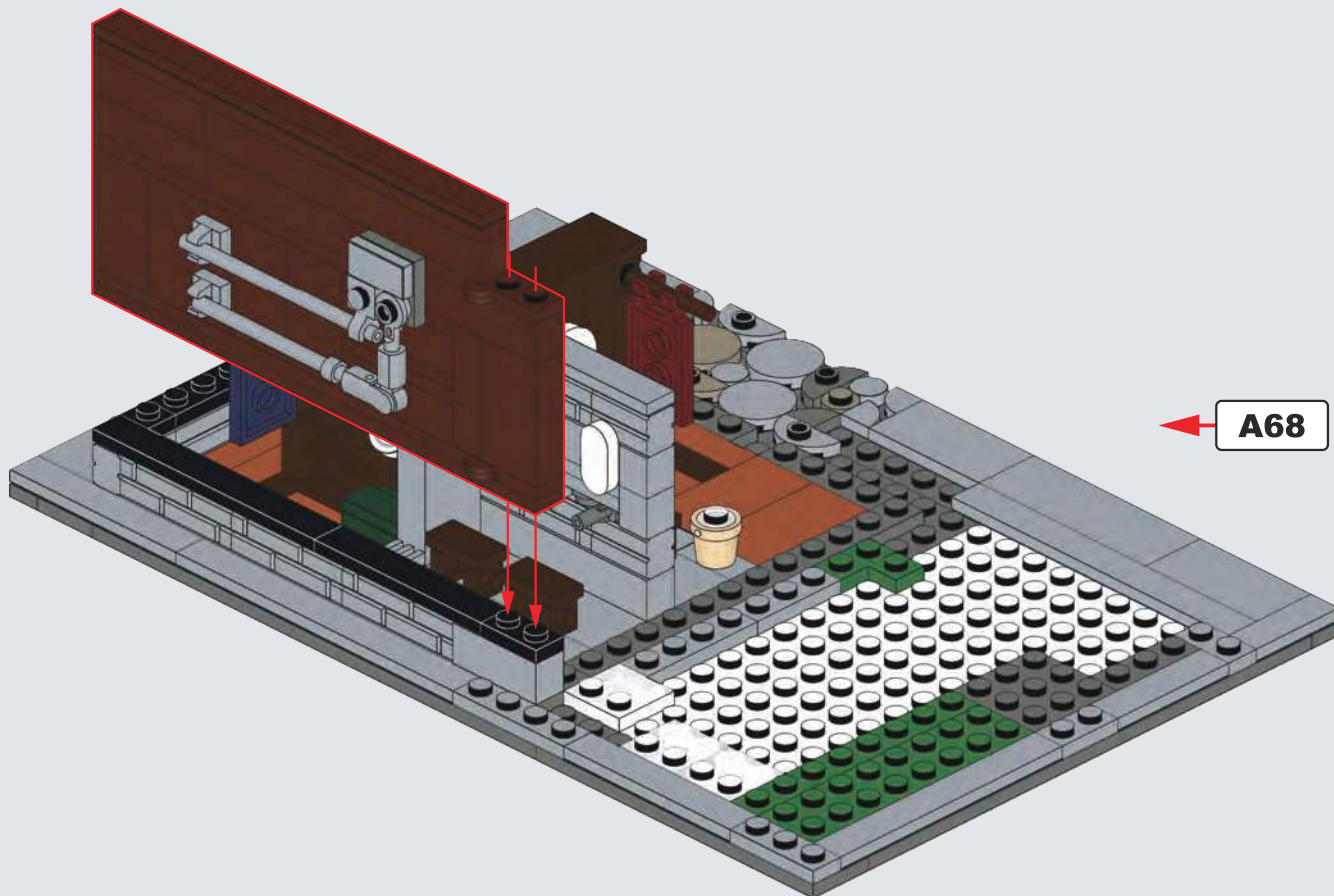
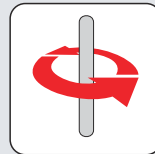

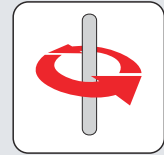
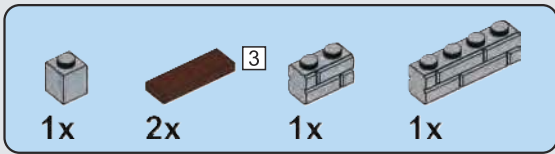

# A83

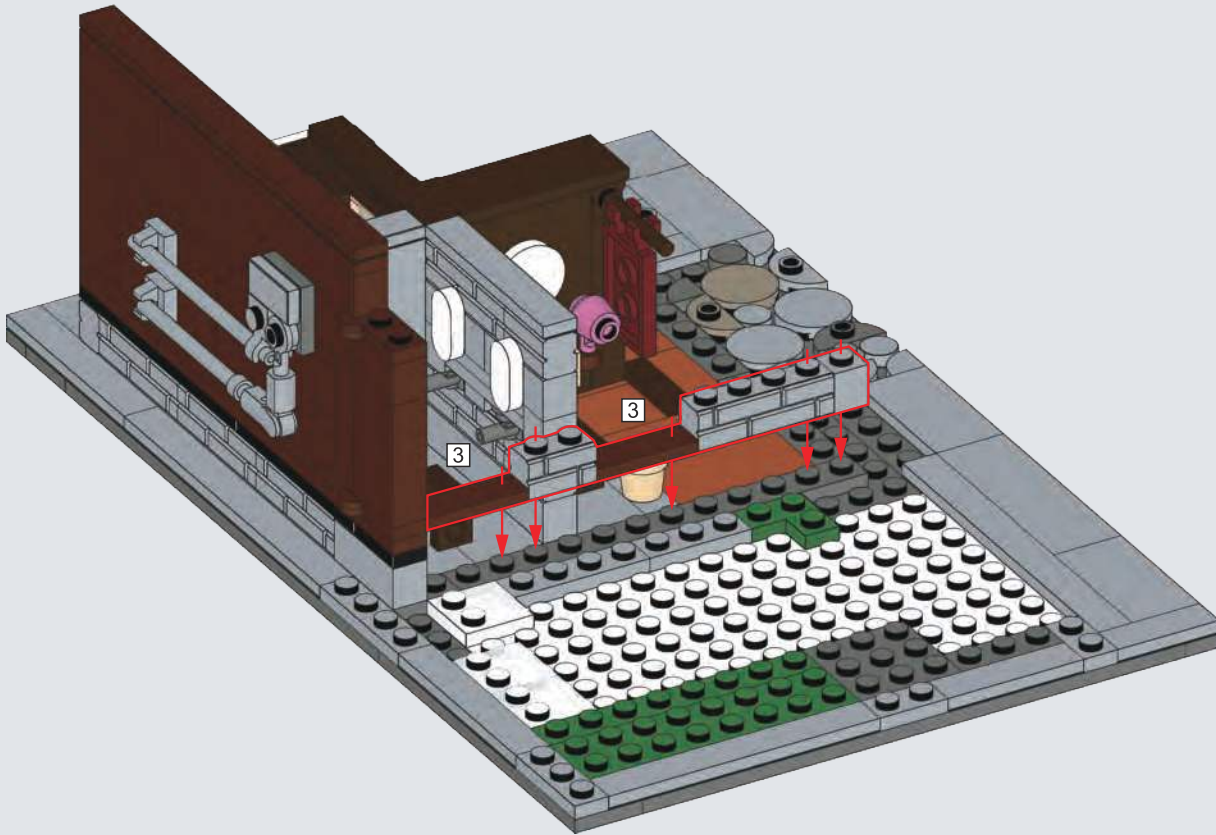

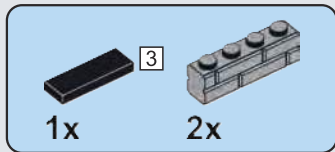

# A84

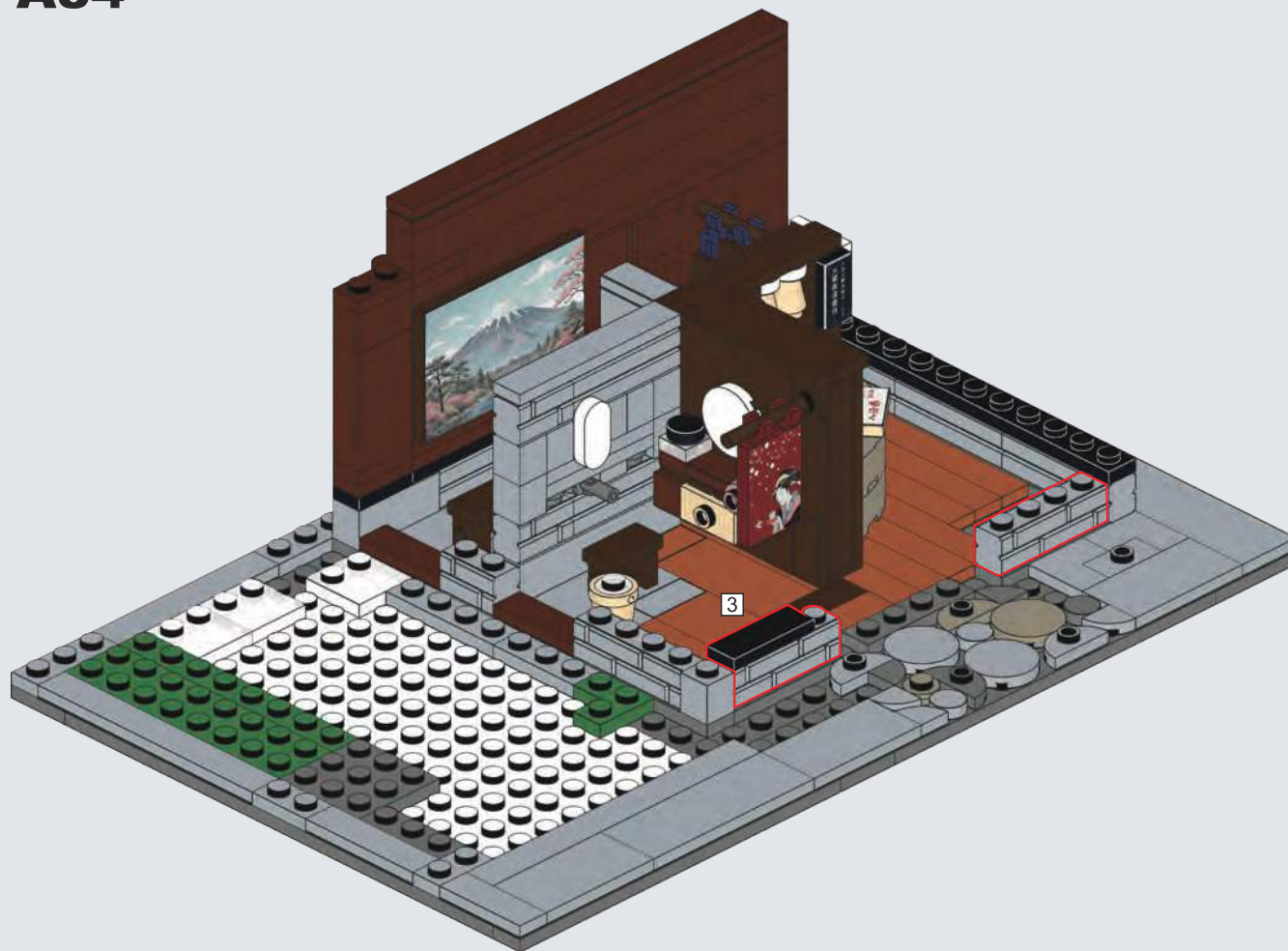

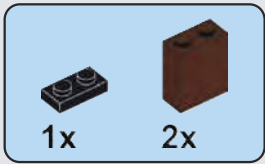

## A85

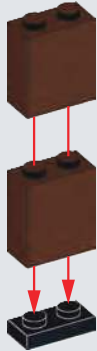

## A86

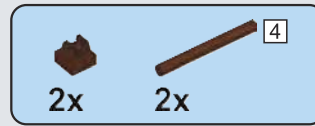

## A87

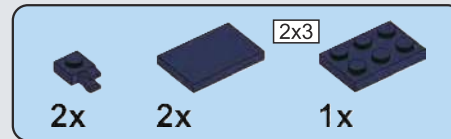
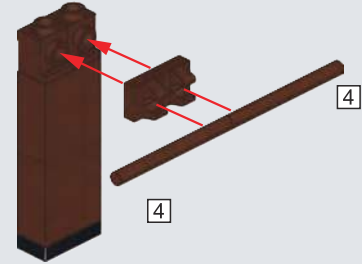
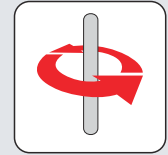

## A88

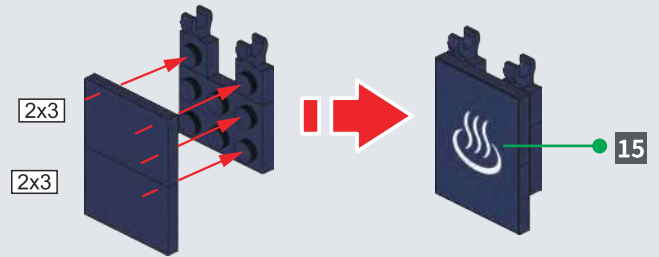

# A89

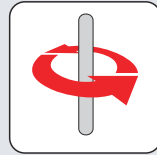
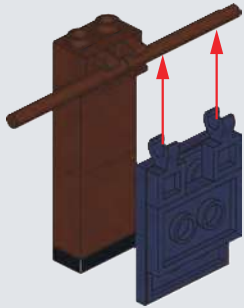

# A91

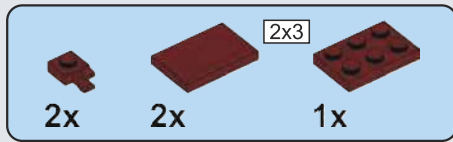

# A90

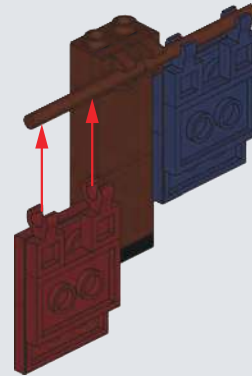
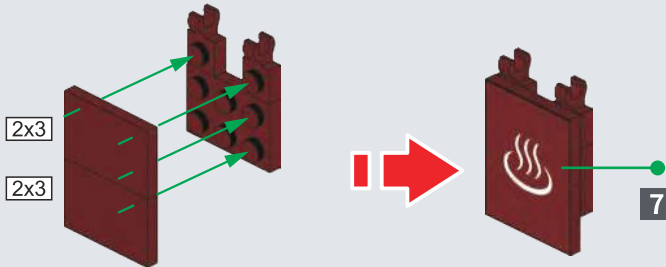

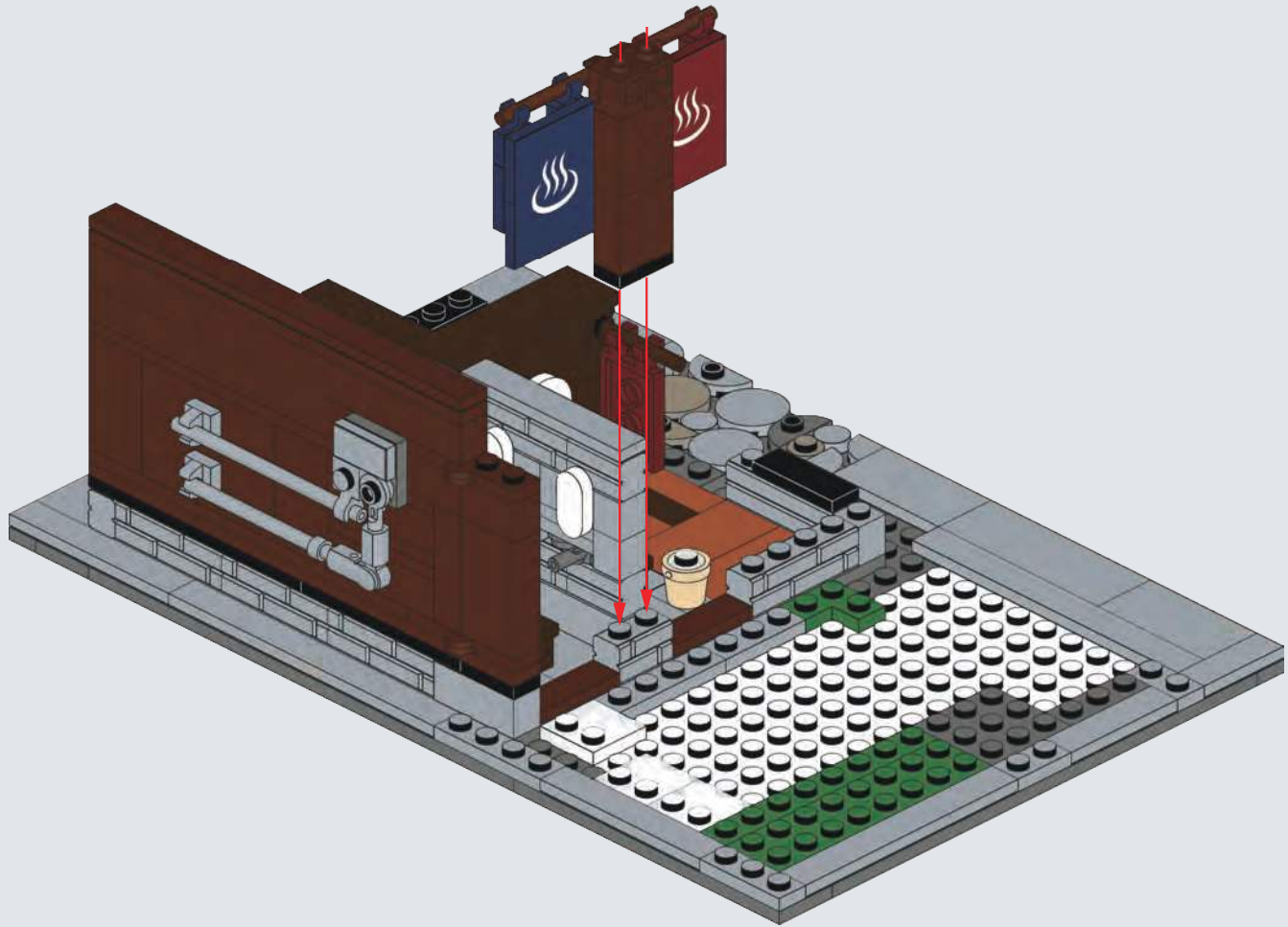

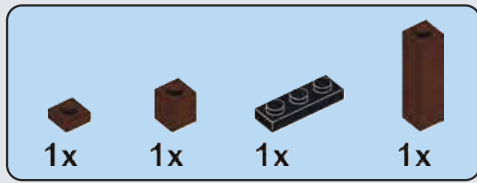

**A93**

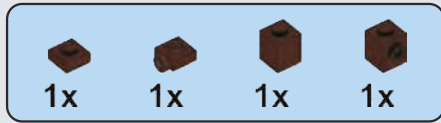
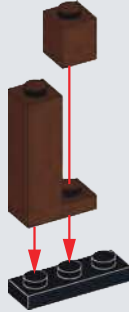

**A94**

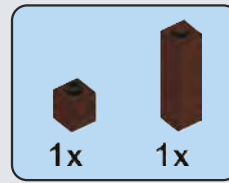
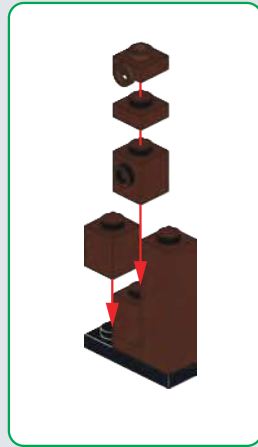
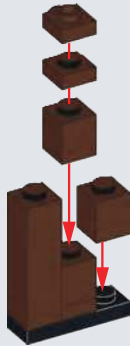

**A95**

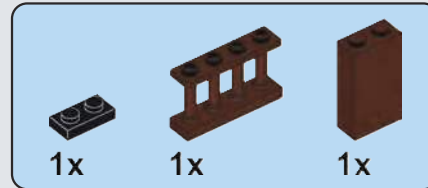

**A96**

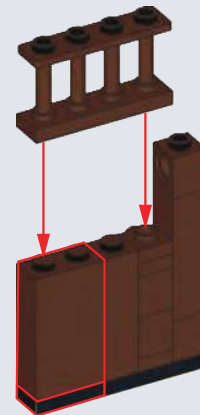

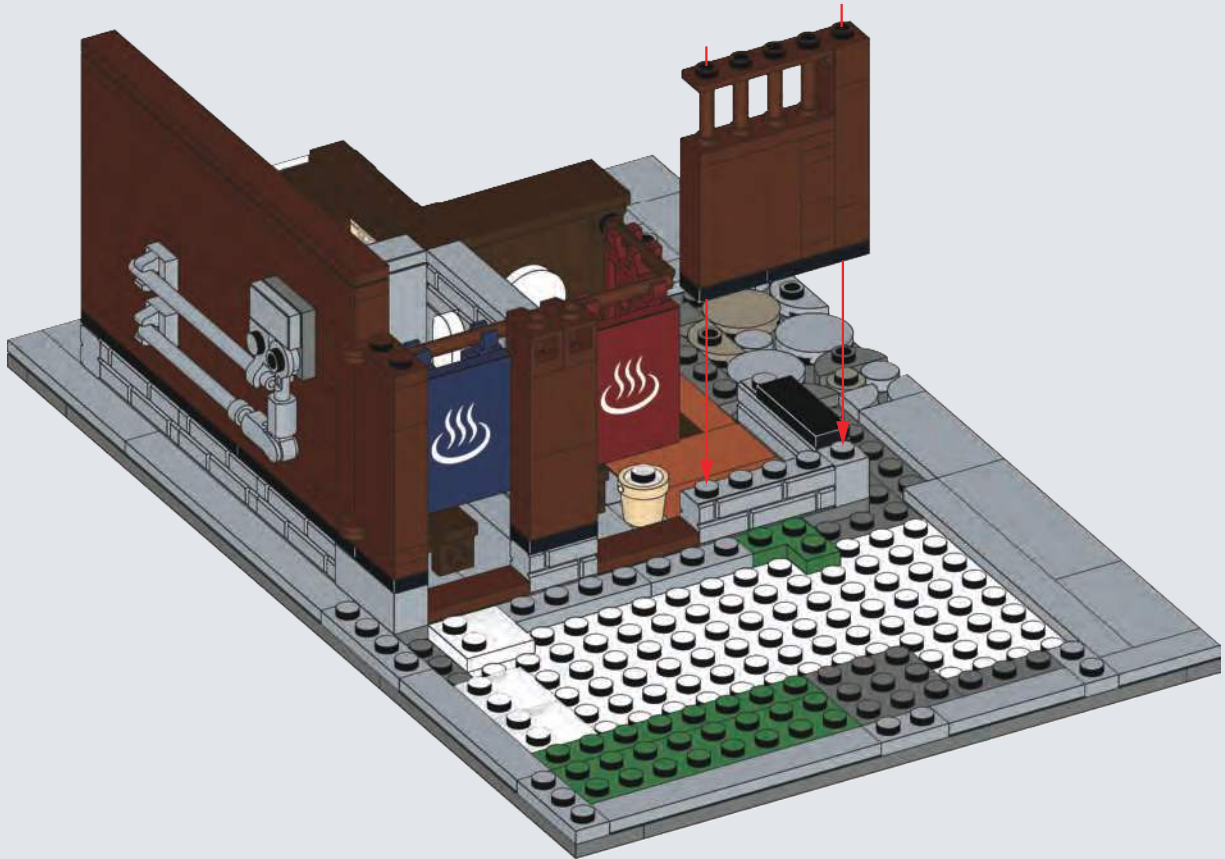
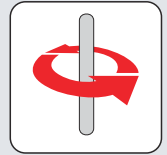

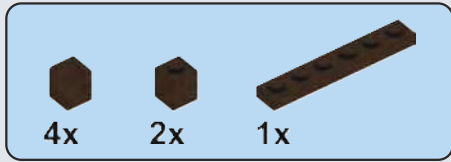

## A98

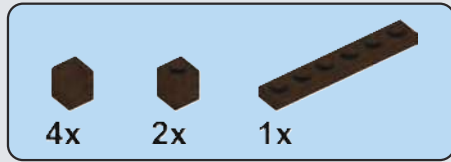
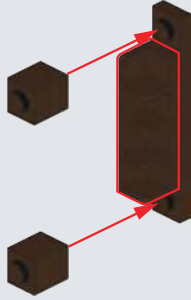

## A99

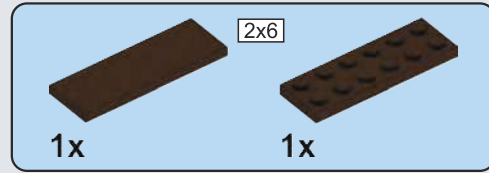

## A100

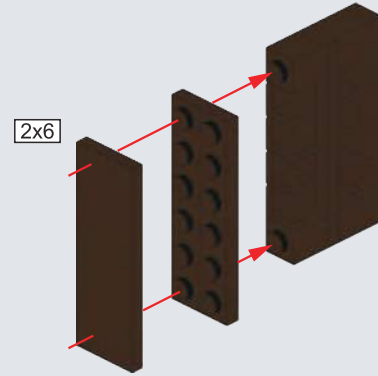

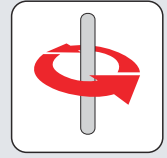

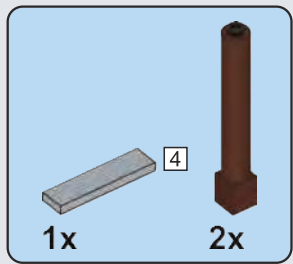

# A102



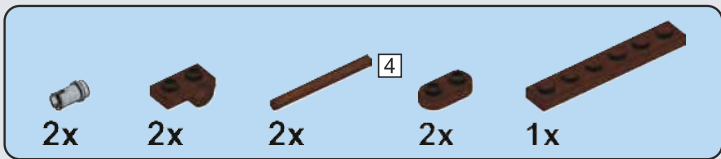

# A103

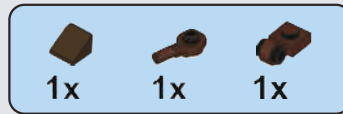
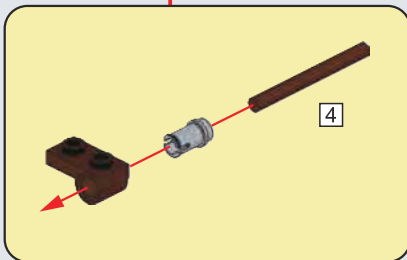
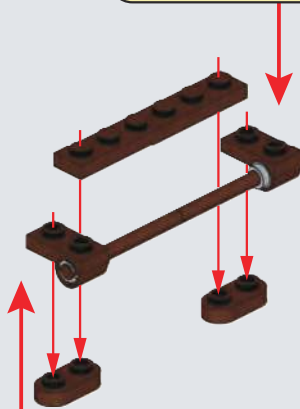
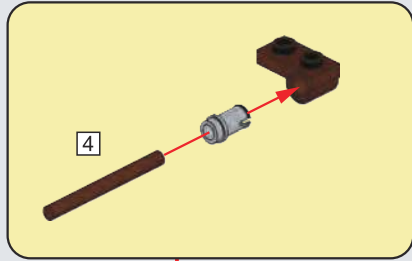

# A104

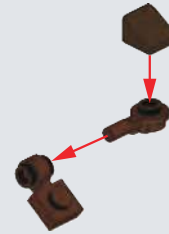

# A105

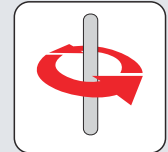
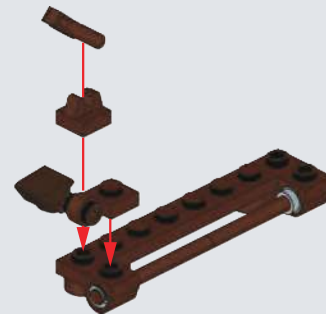

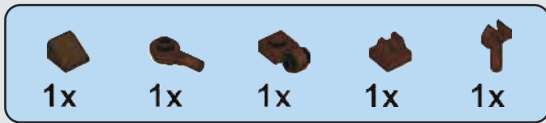

## A106

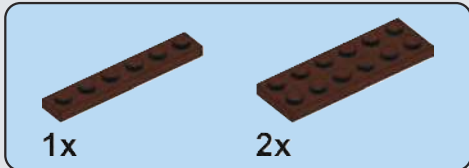
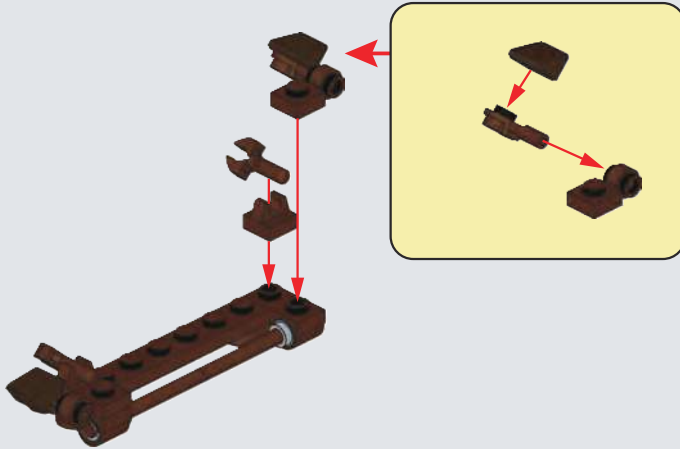

## A107

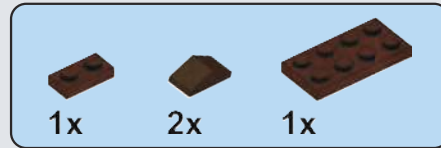
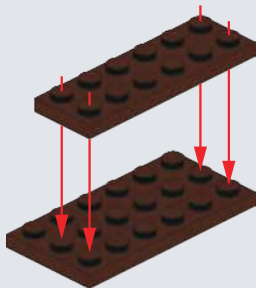

## A108

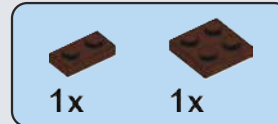
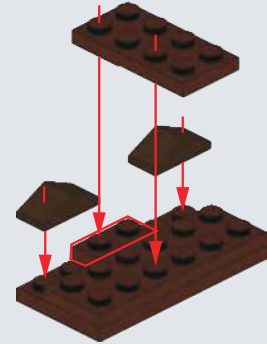

## A109

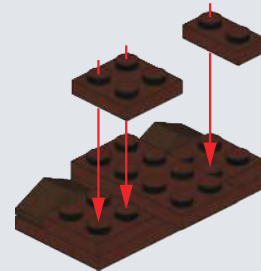

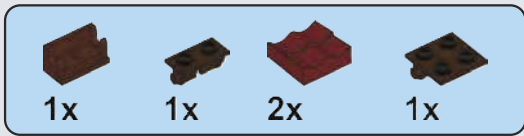

# A110

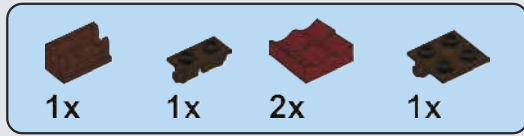
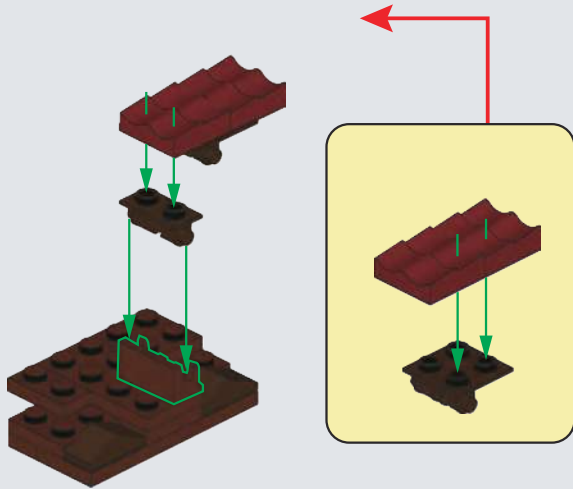
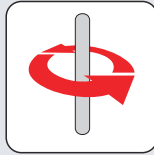

# A111

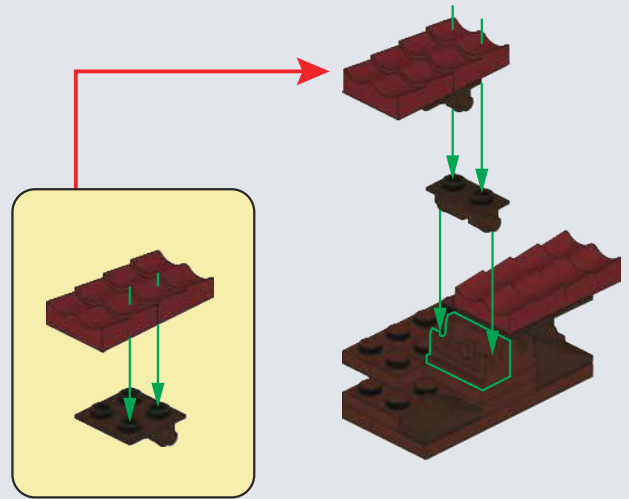

# A112

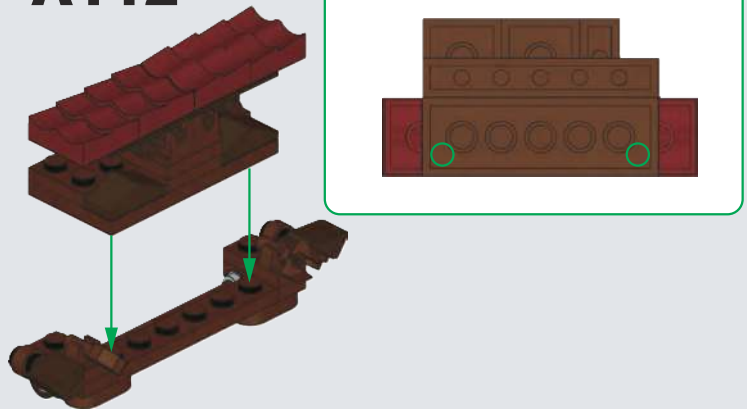

# A113

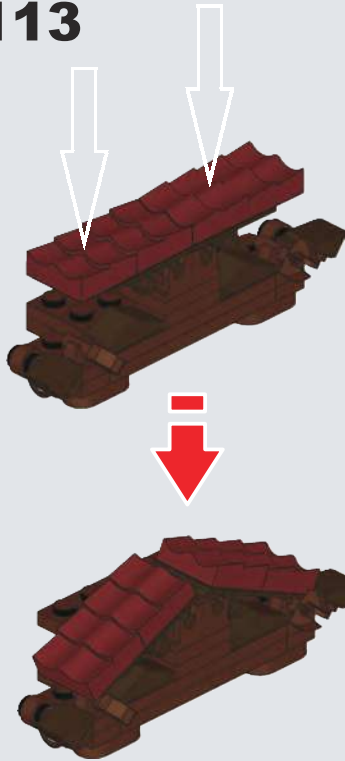

# A114

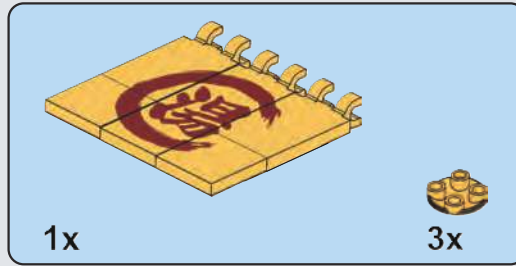
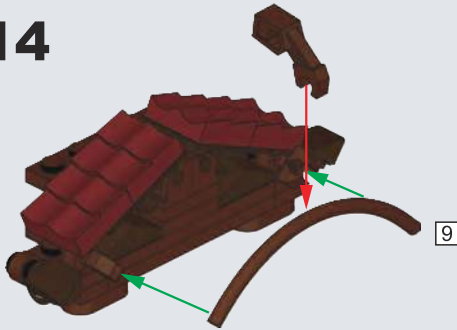

# A115

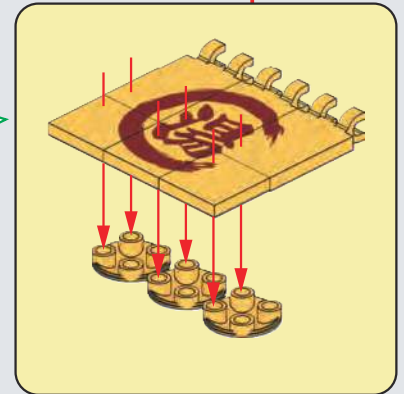
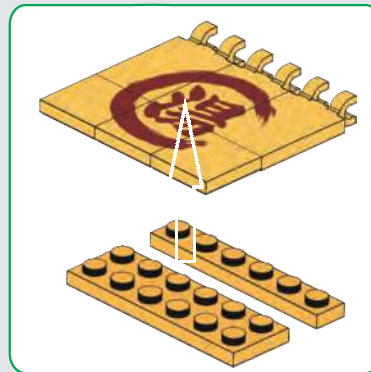
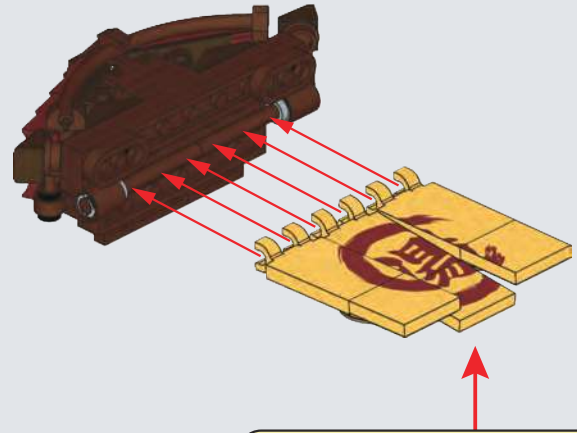

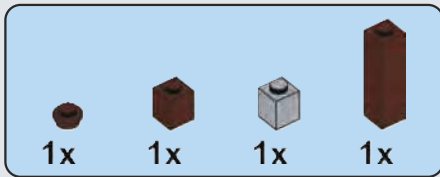

## A116

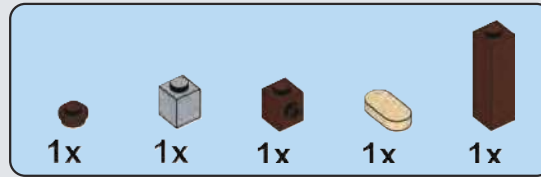

## A117

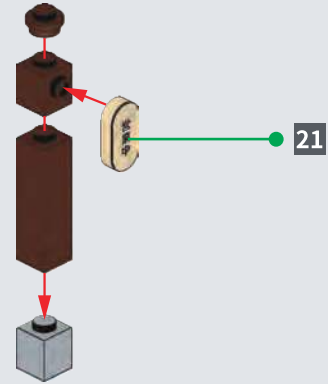

## A118

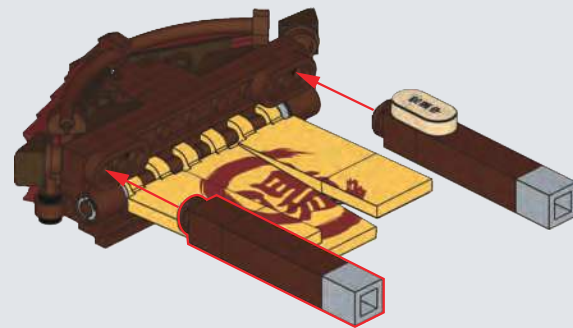

A119



← A102

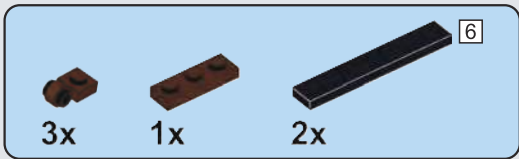

## A120

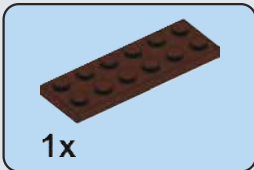
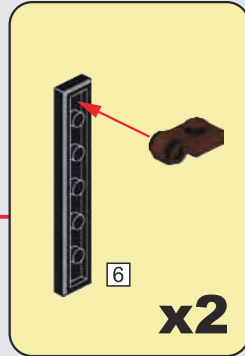
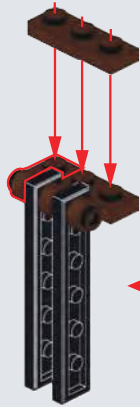

## A121

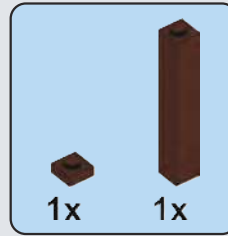
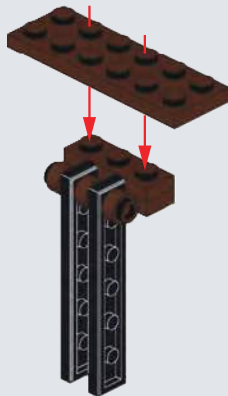

## A122

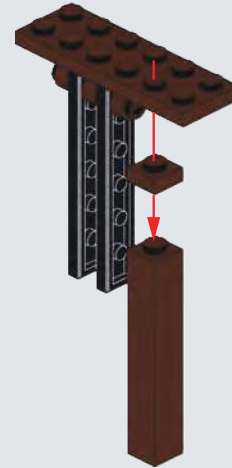

A123

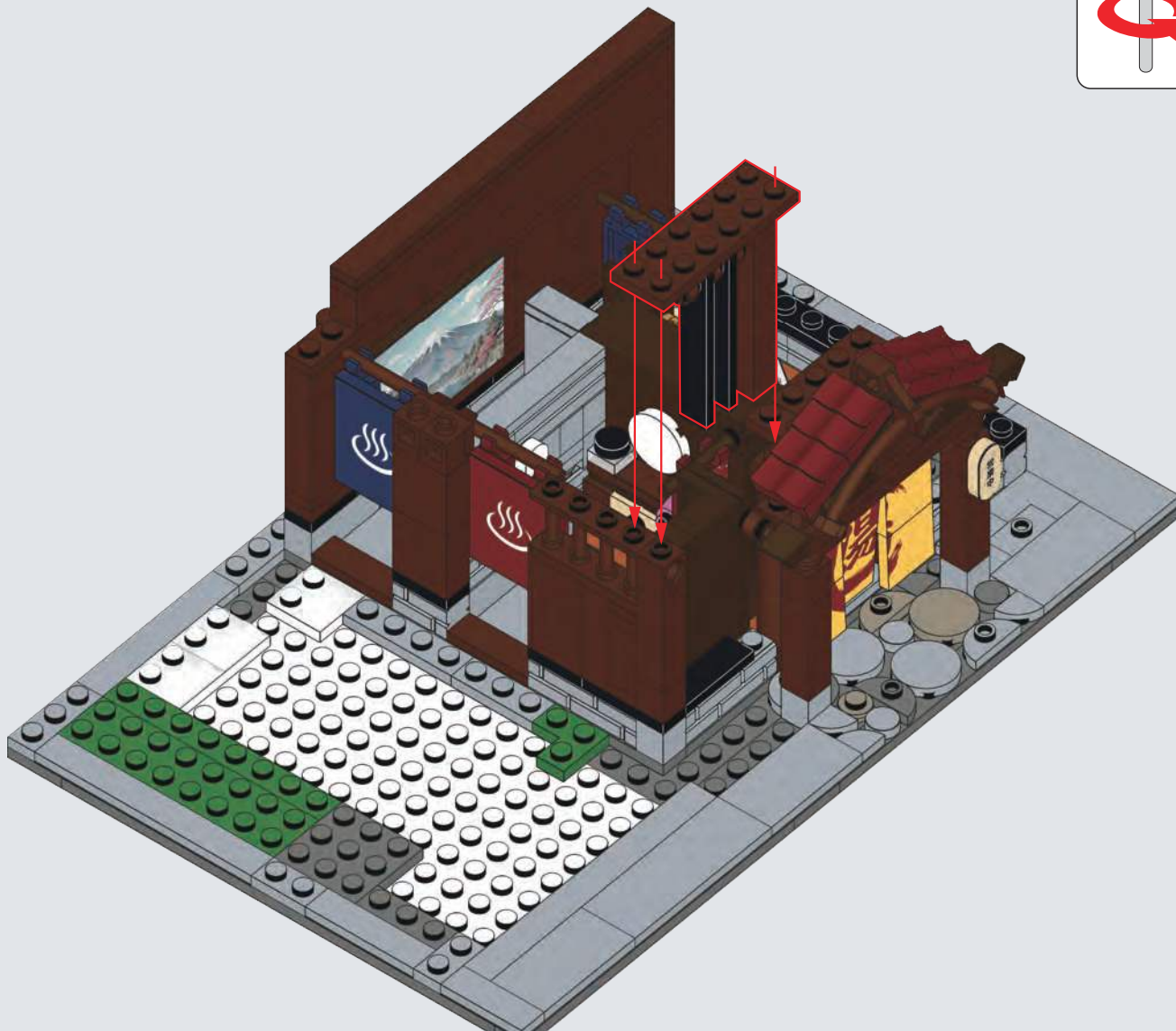
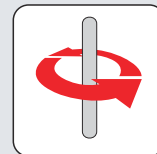

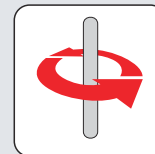
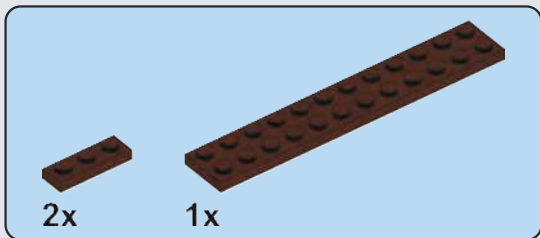

**A124**

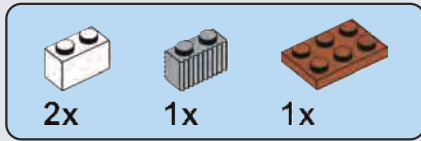
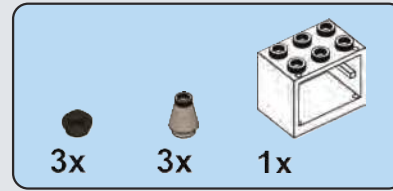
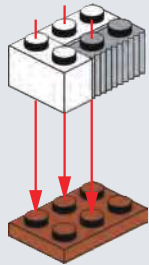
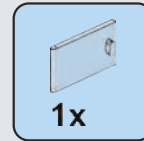
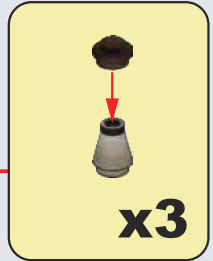
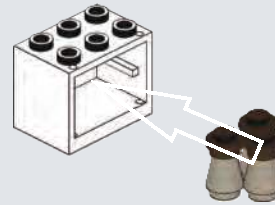
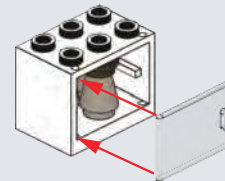

**B****B1****B2****B3**

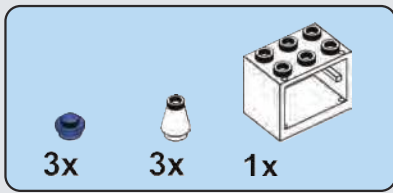

**B4**

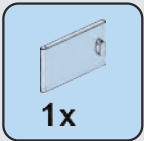
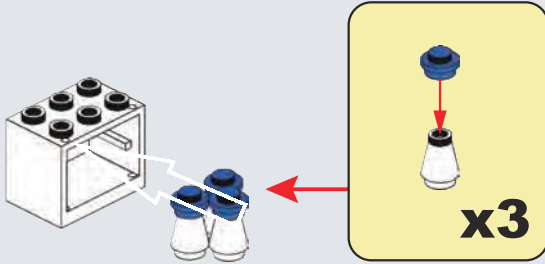

**B5**

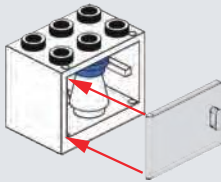

**B6**

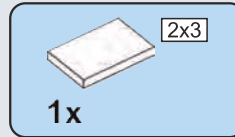
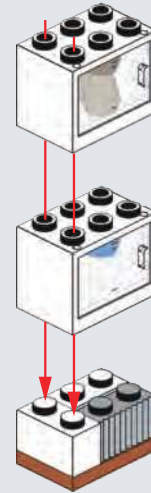

**B7**

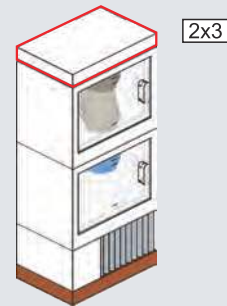

**B8**





## B9

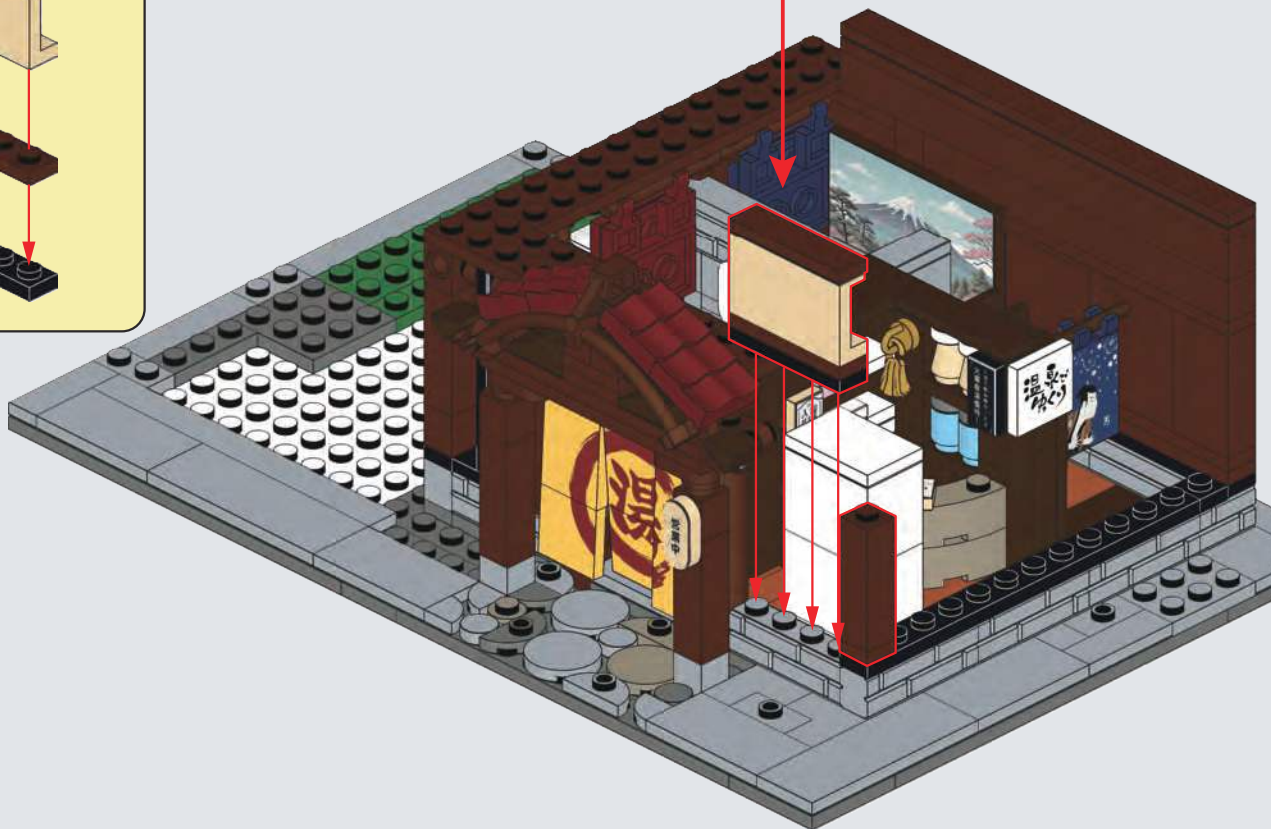
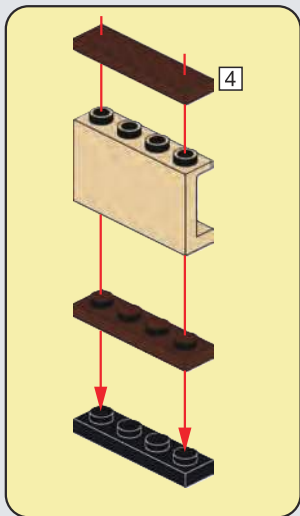



## B10

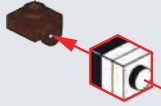

## B11

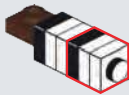

## B12

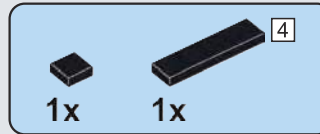
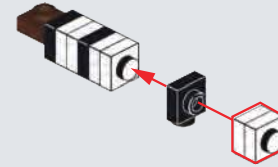

## B13

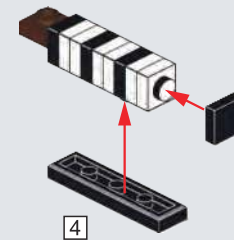

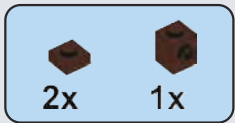

# B14

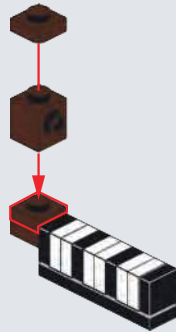

# B15

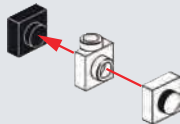

# B16

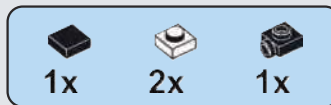
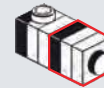

# B17

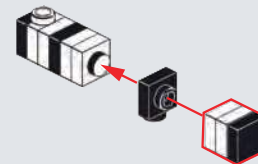

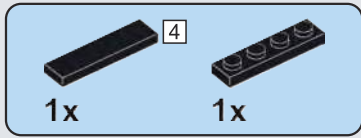

### B18

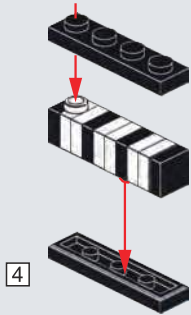

### B19

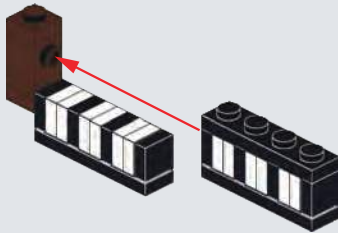

### B20



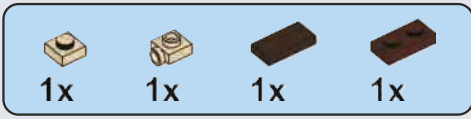

## B21

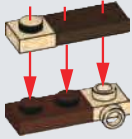

## B22

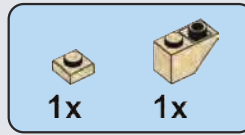
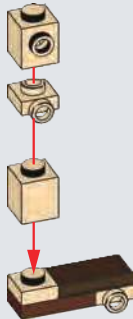

## B23

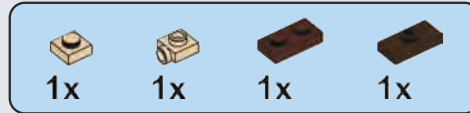
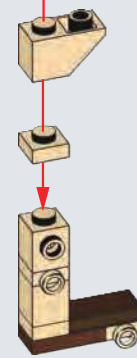

## B24

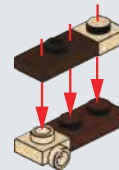

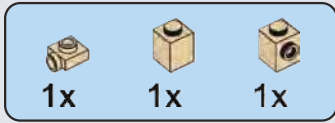

## B25

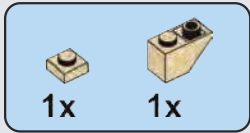
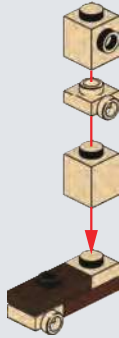

## B26

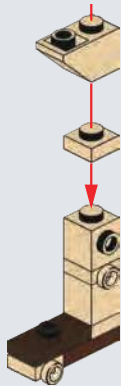

## B27

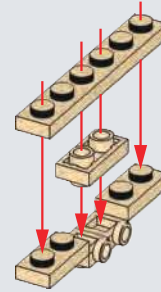

## B28

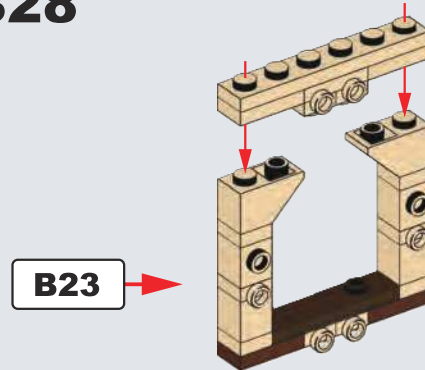

← B26

B23 →



**B29**

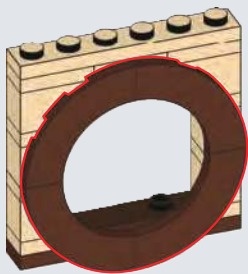

**B30**

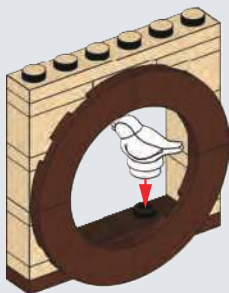

**B31**

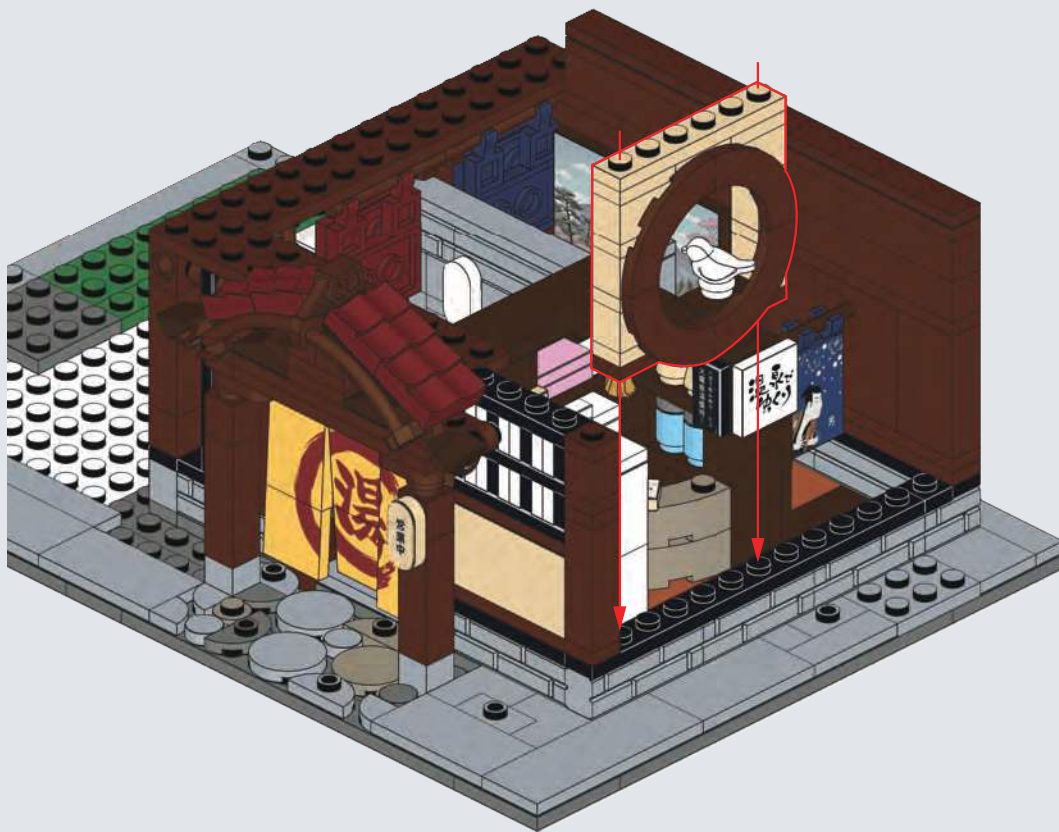

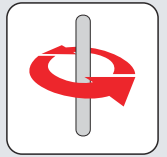
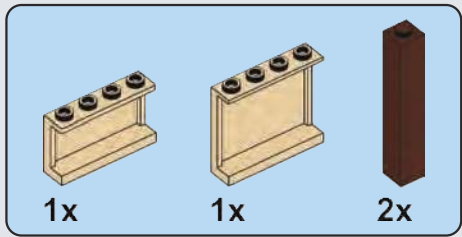

## B32

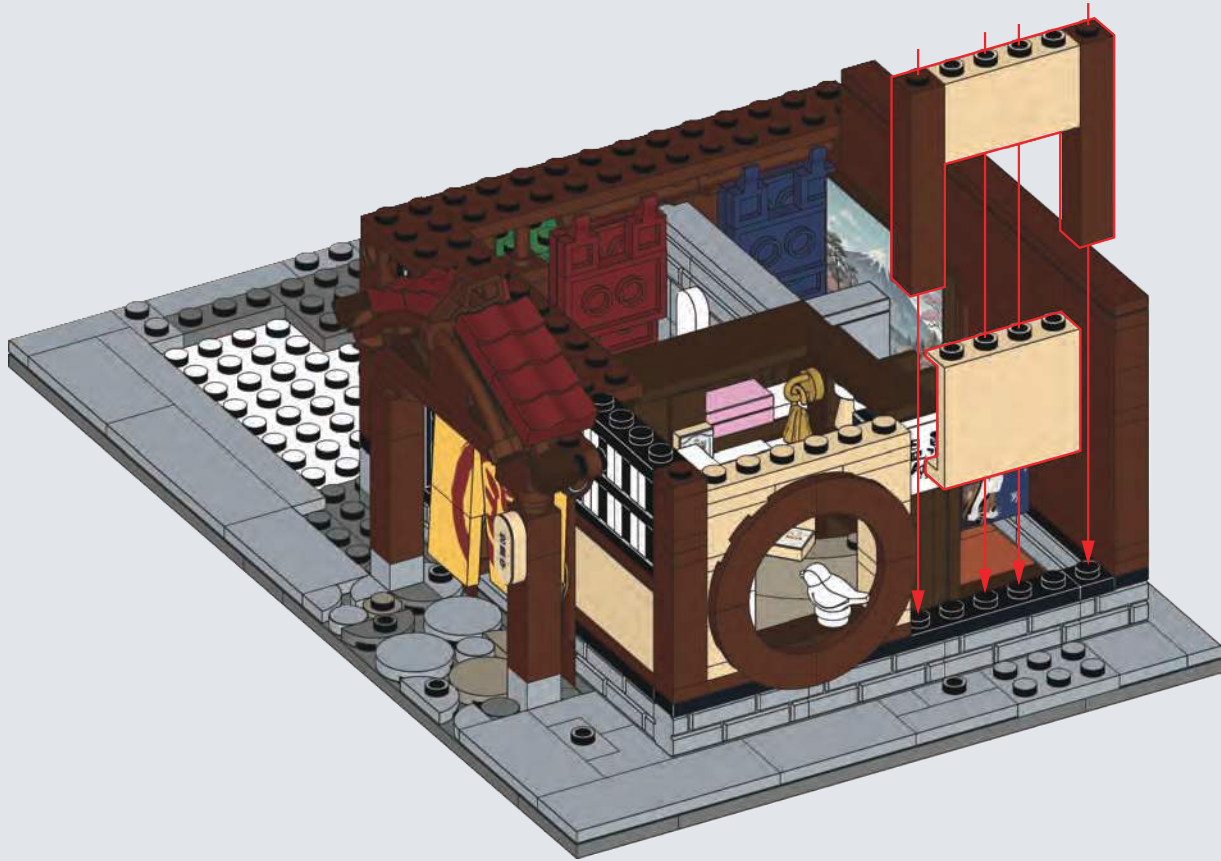

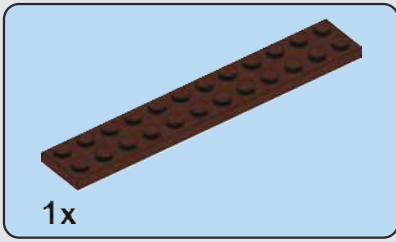

**B33**



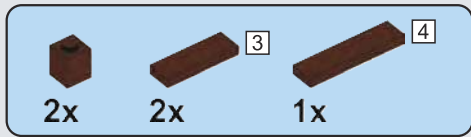

# B34

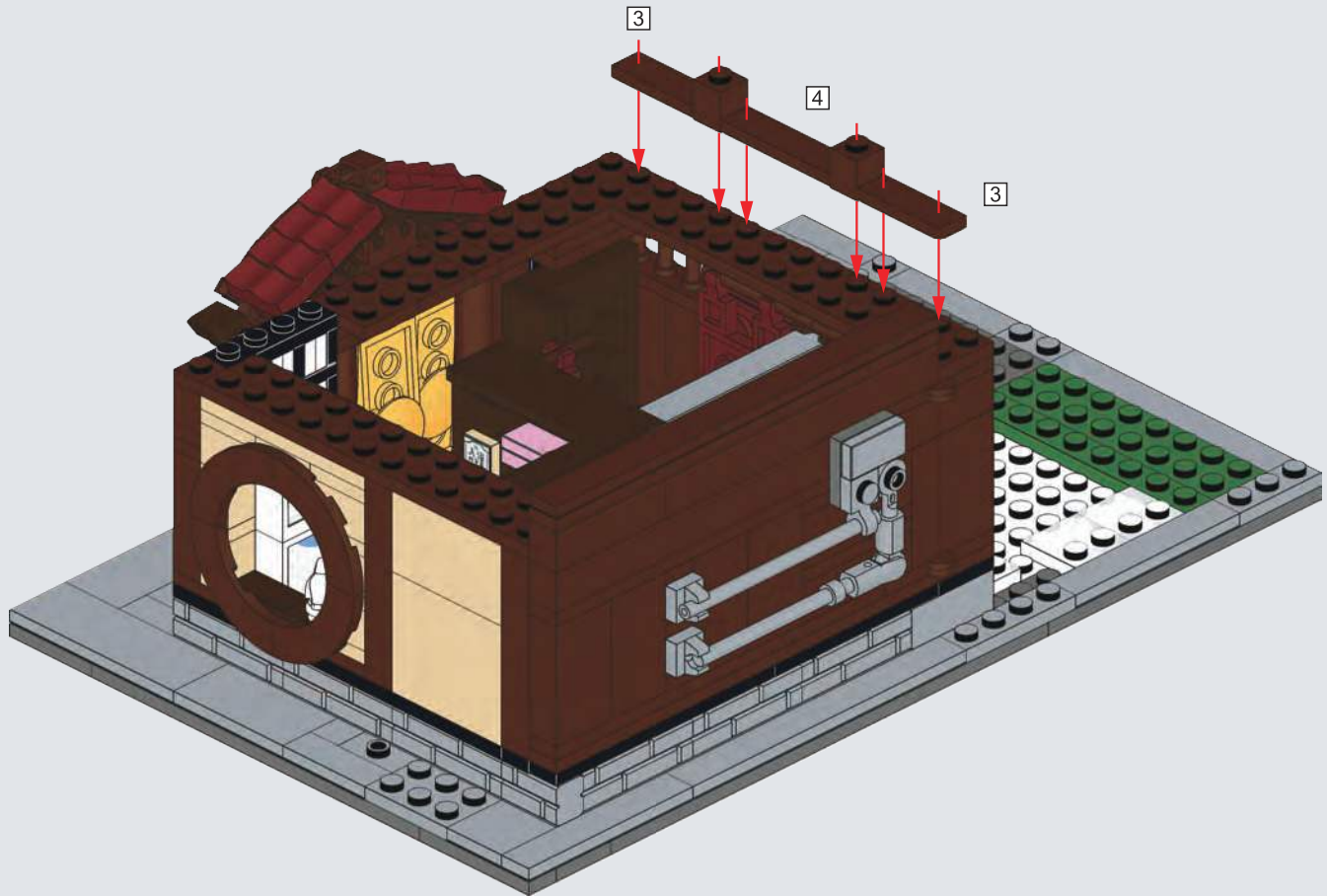

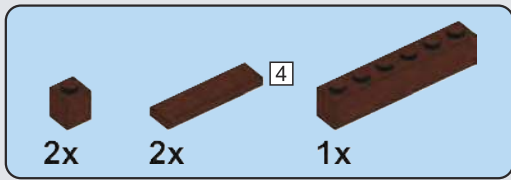

## B35

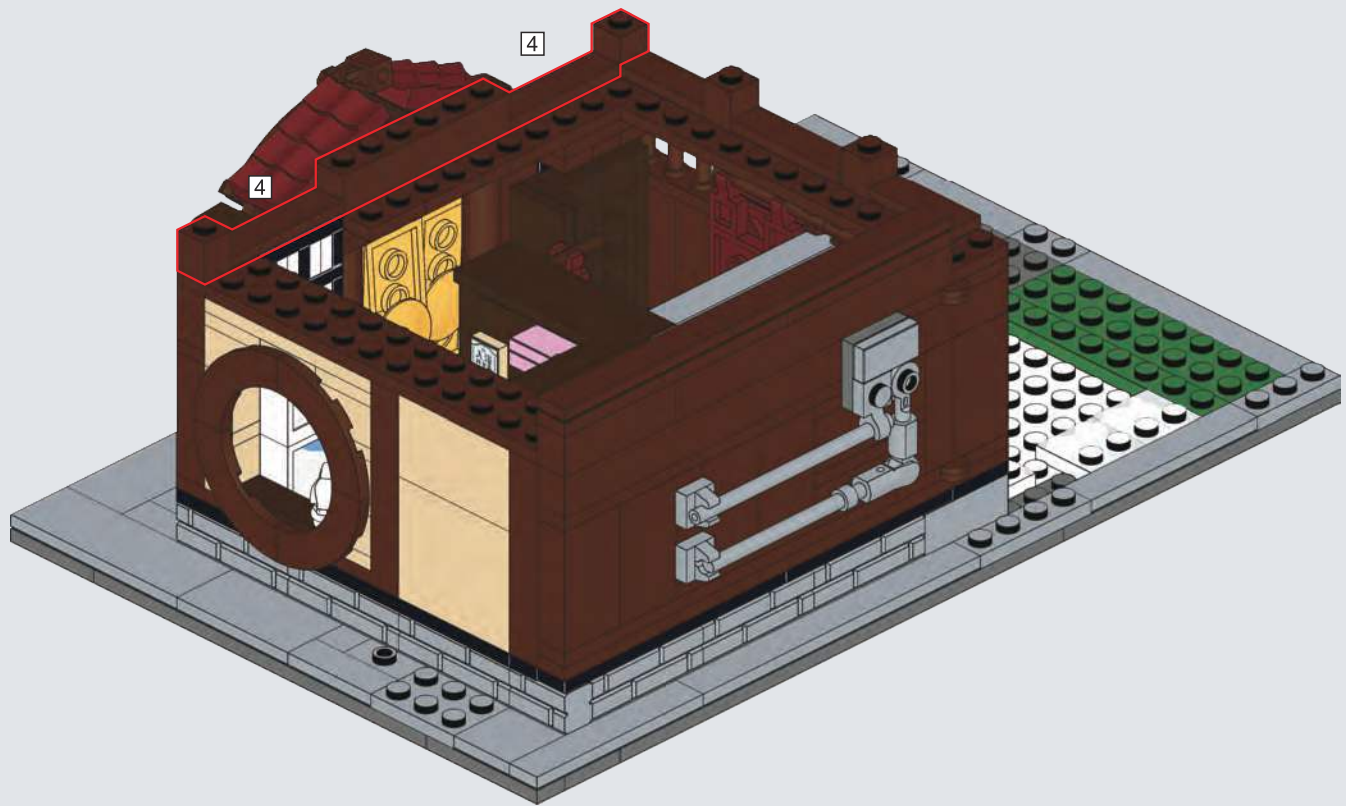

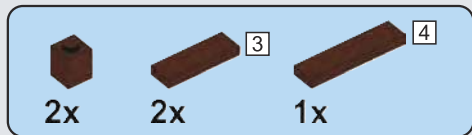

## B36

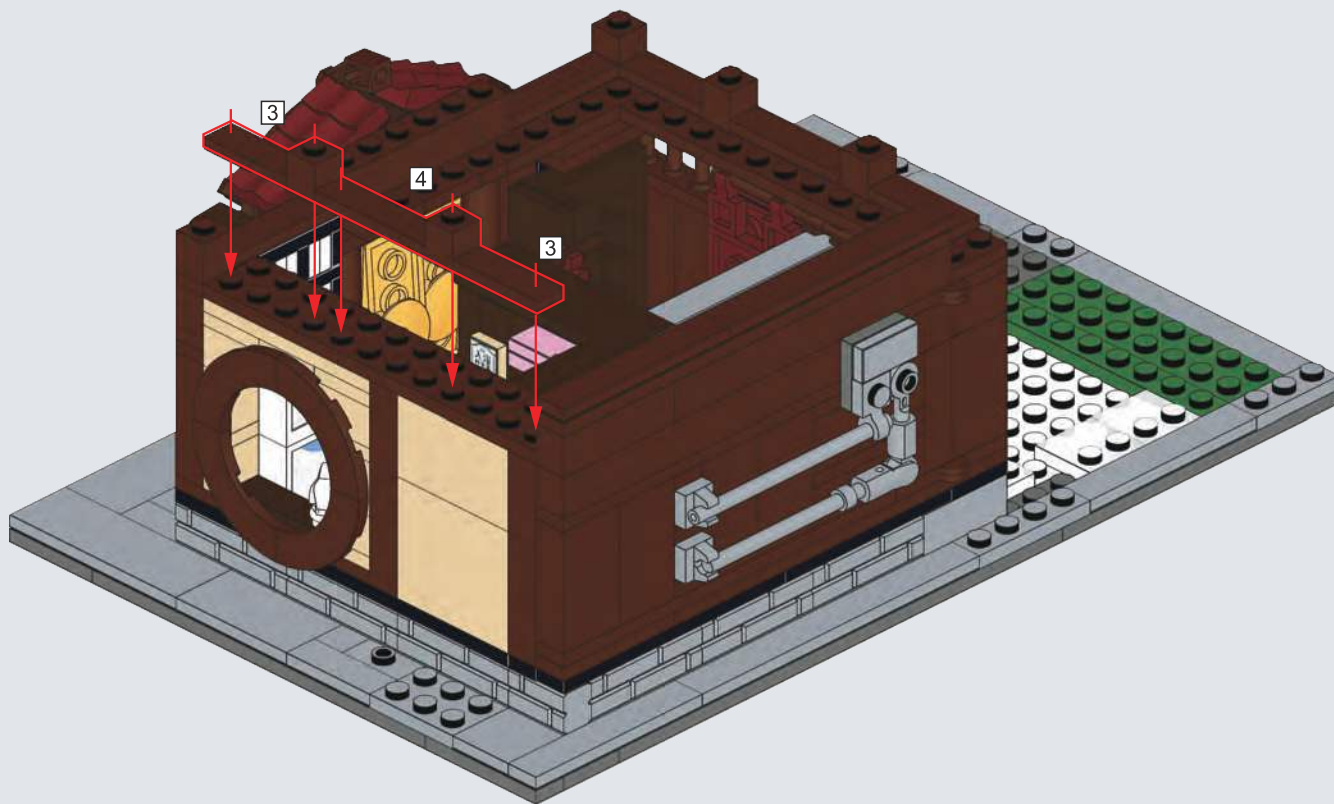

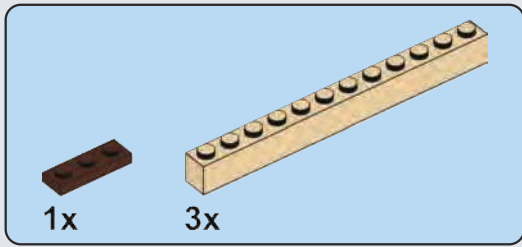

# B37

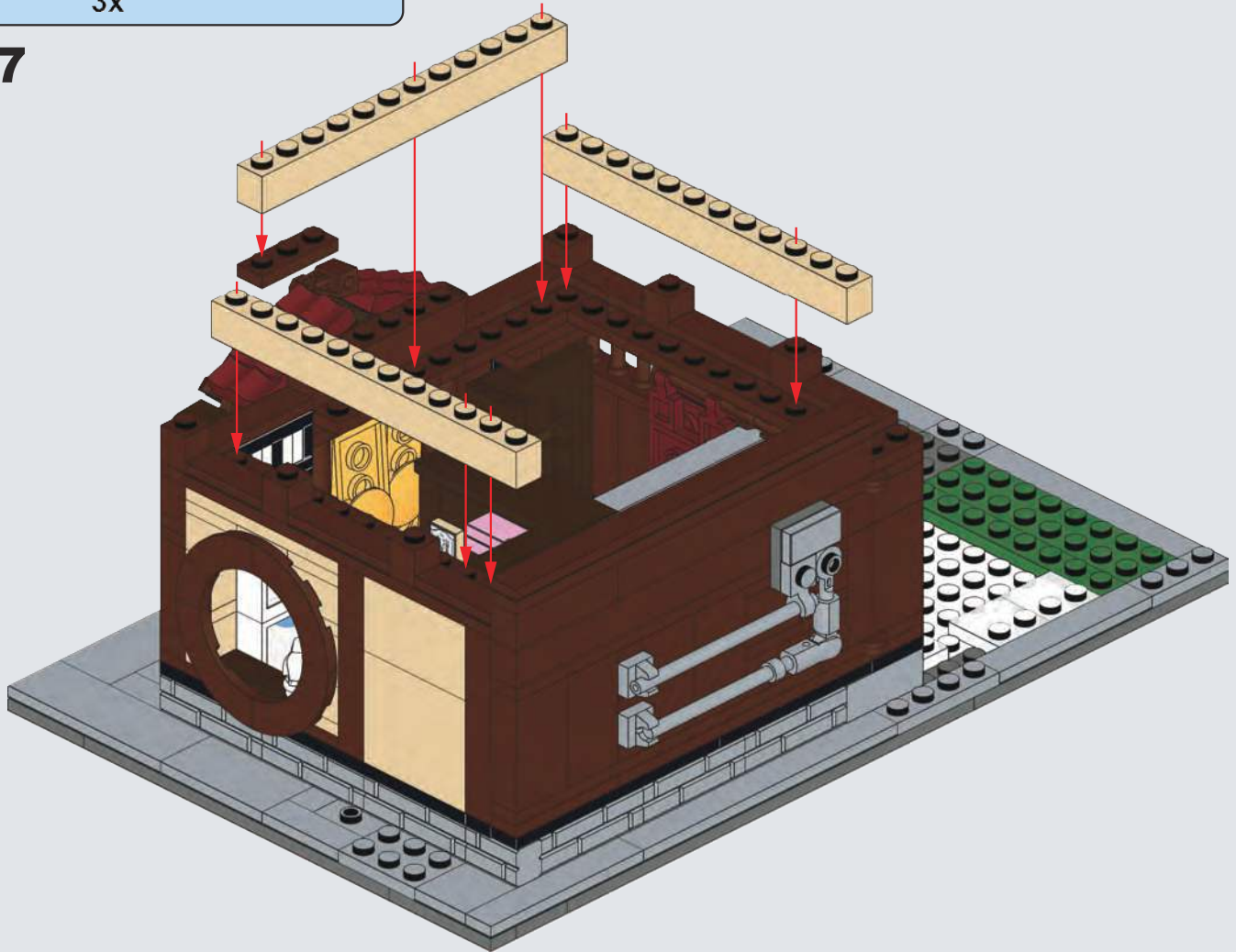

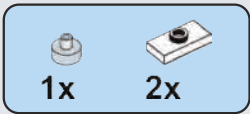

## B38

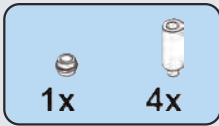
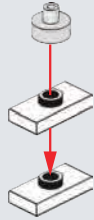

## B39

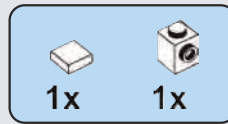

## B40



## B41

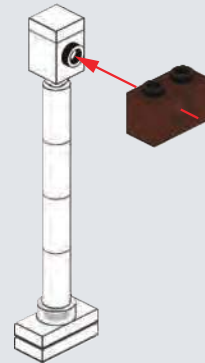

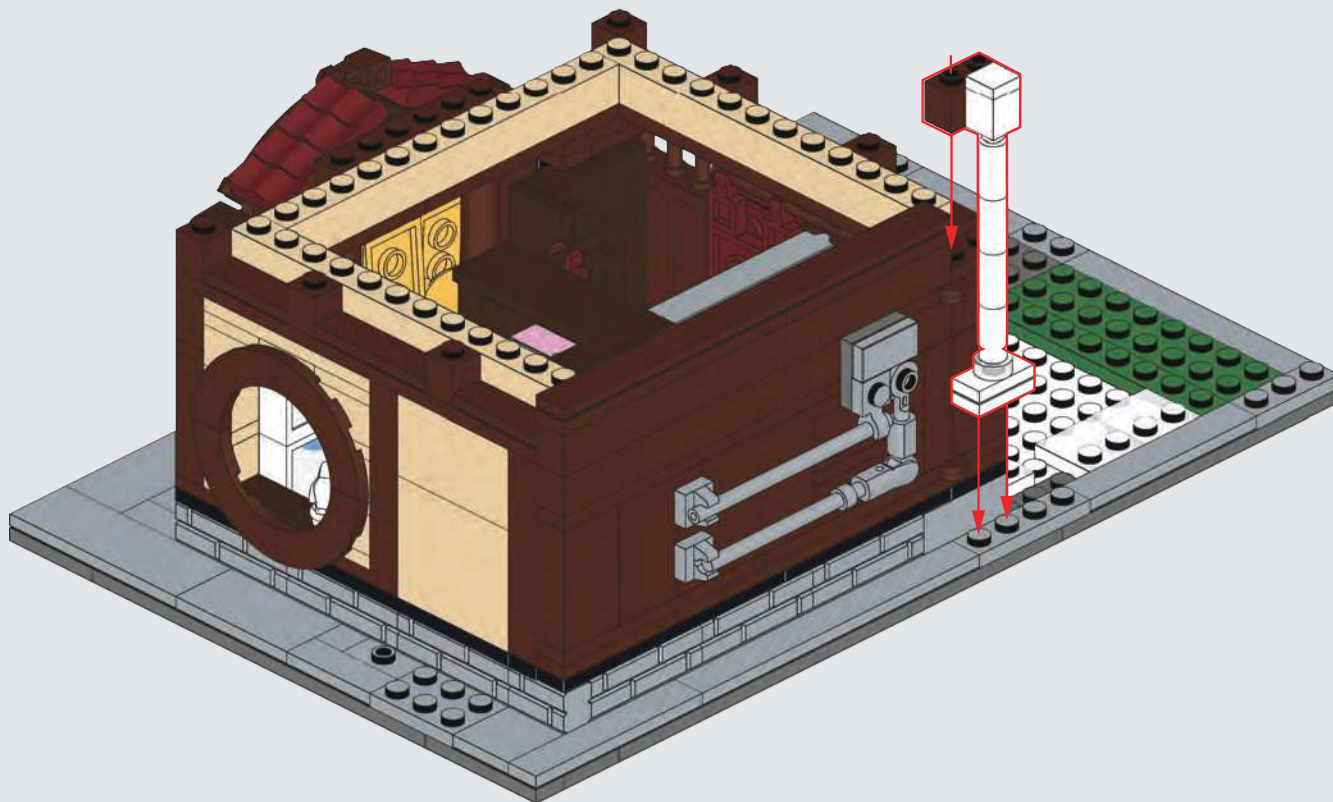



# B43

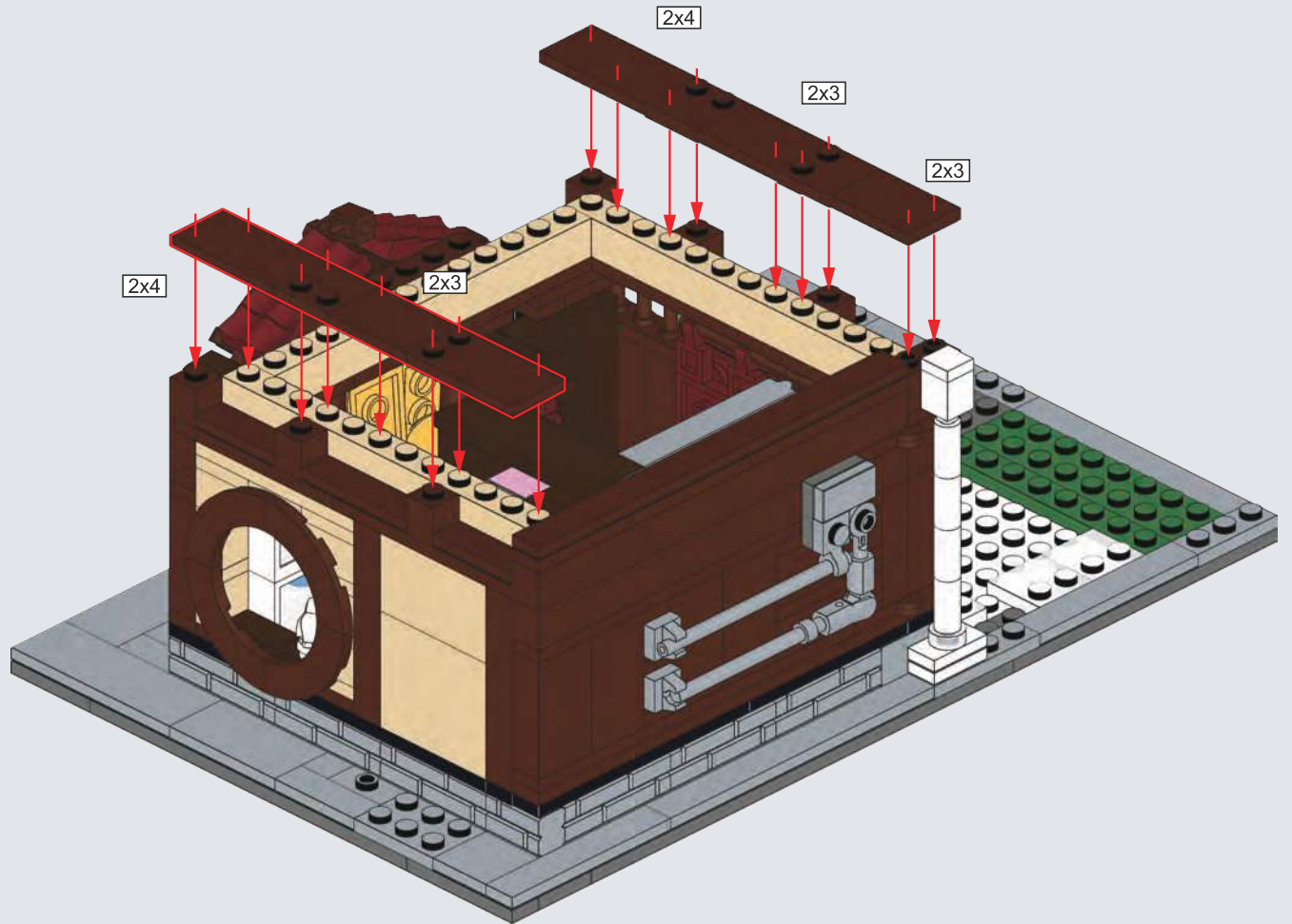

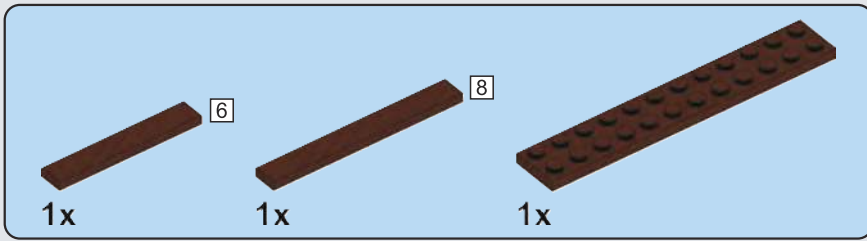

## B44

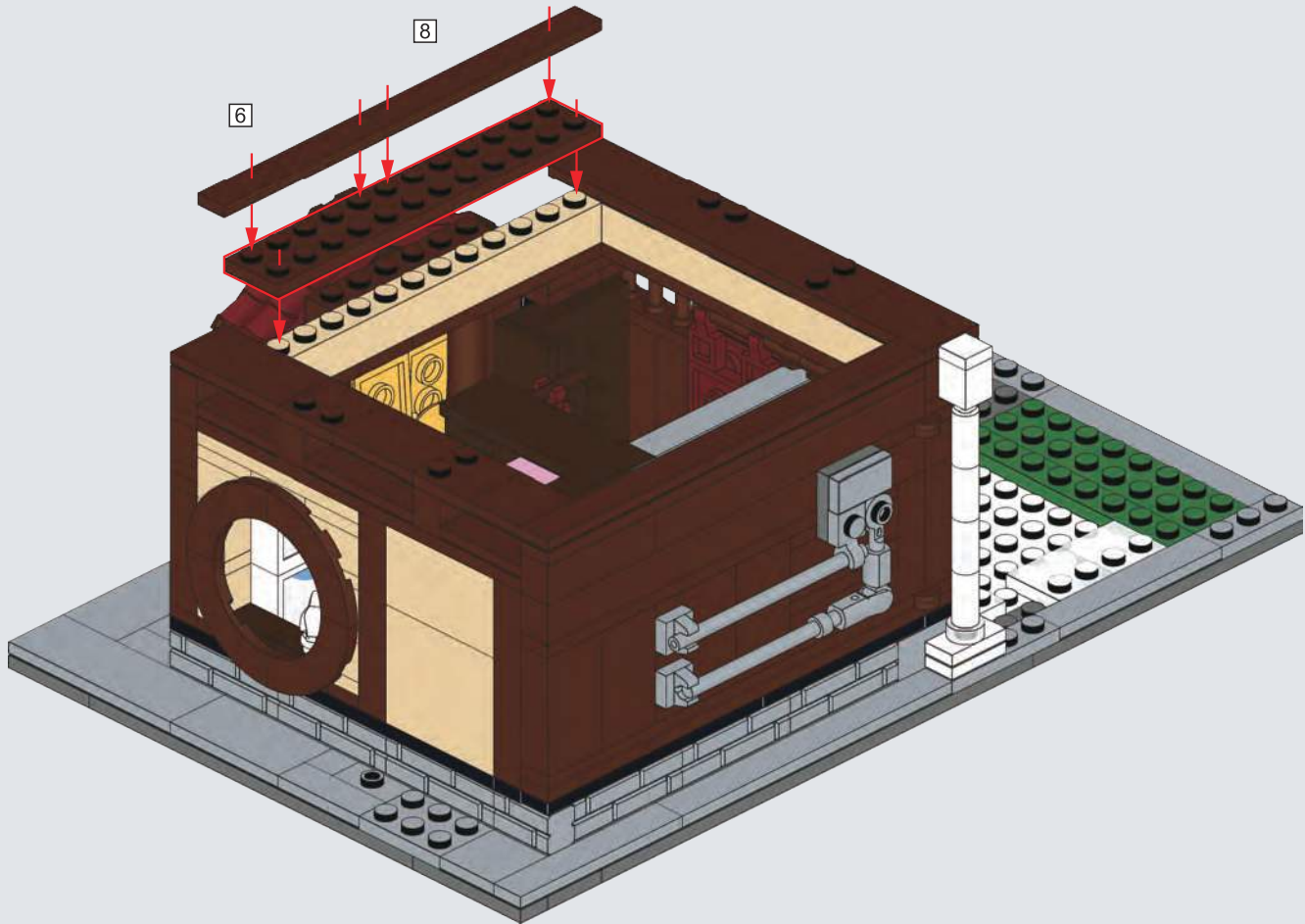

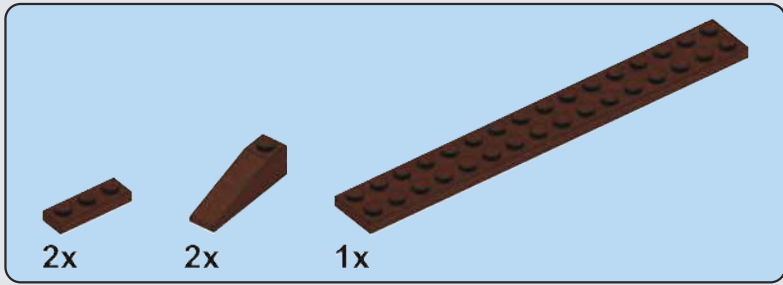

## B45

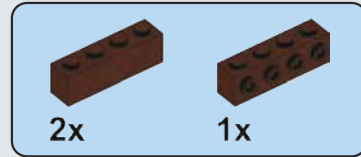
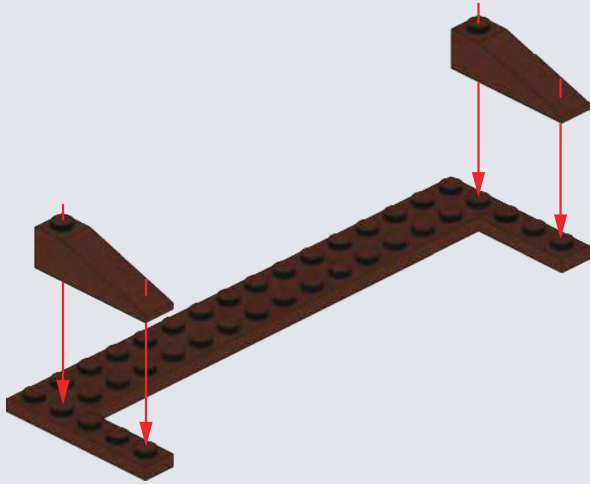

## B46

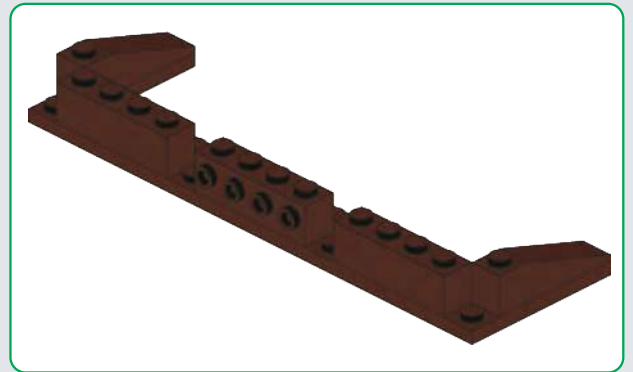
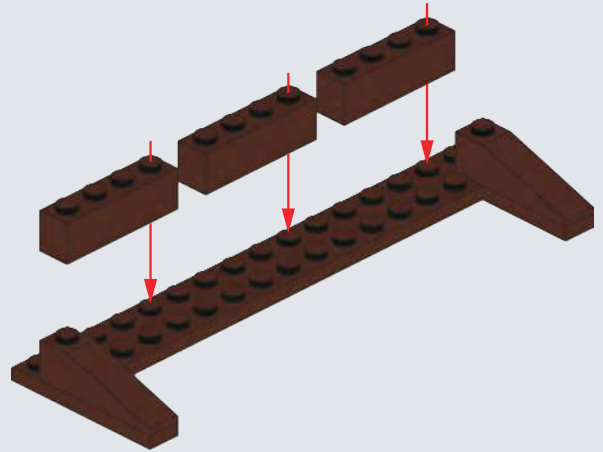

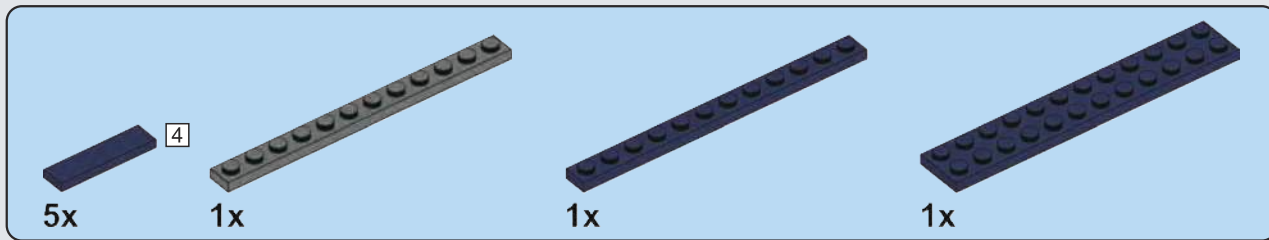

## B47

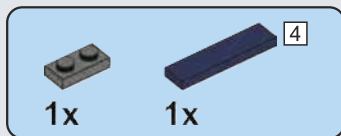
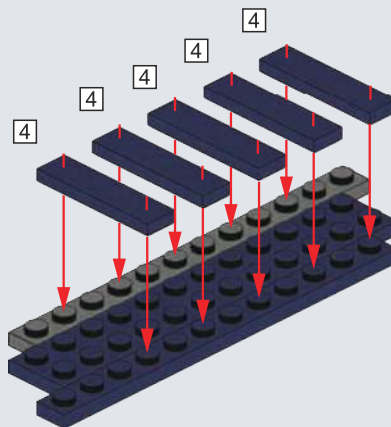

## B48

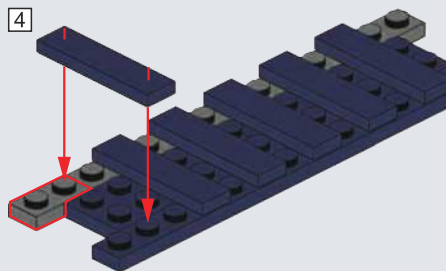

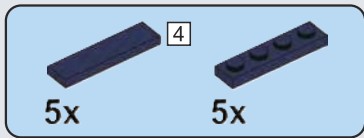

## B49

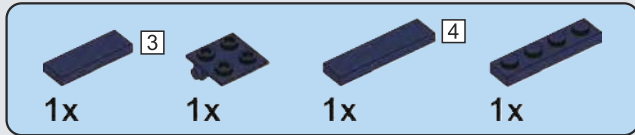
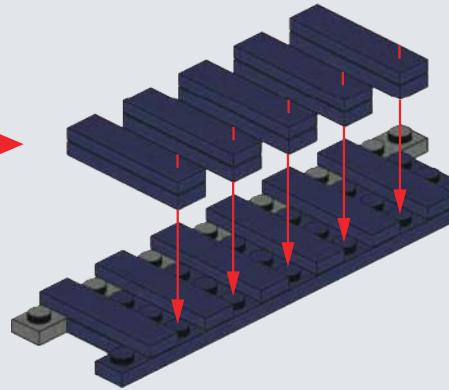
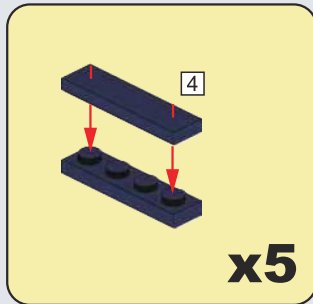

## B50

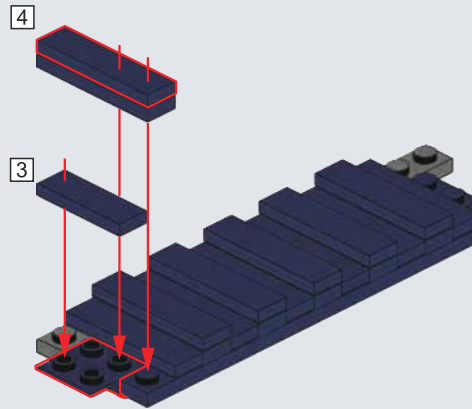

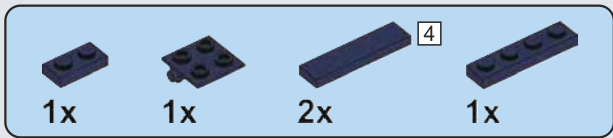

**B51**

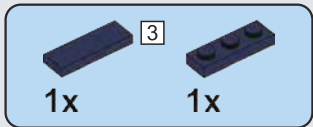
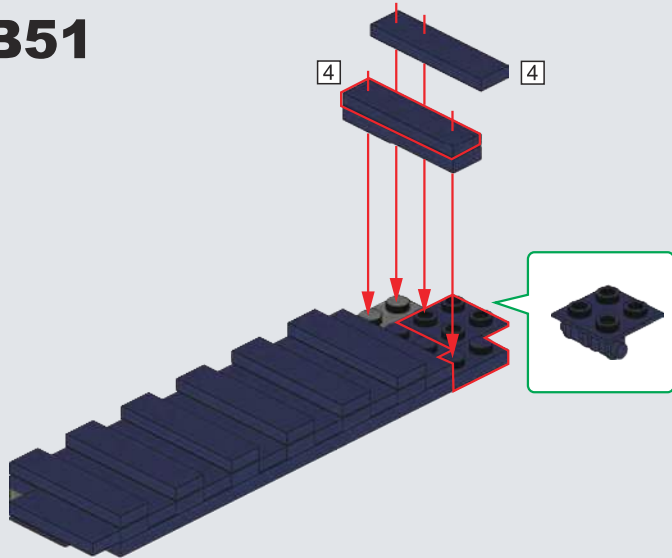

**B52**

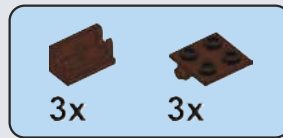
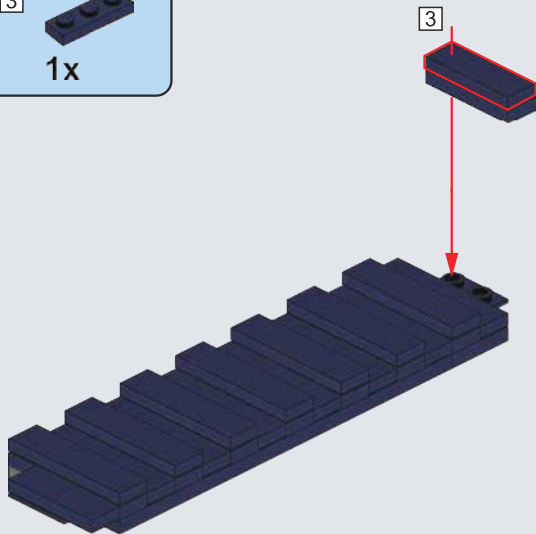

**B53**

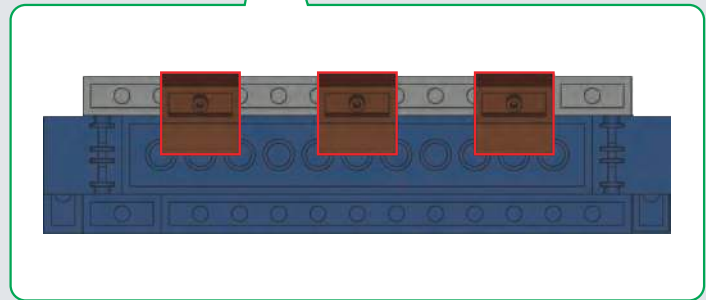
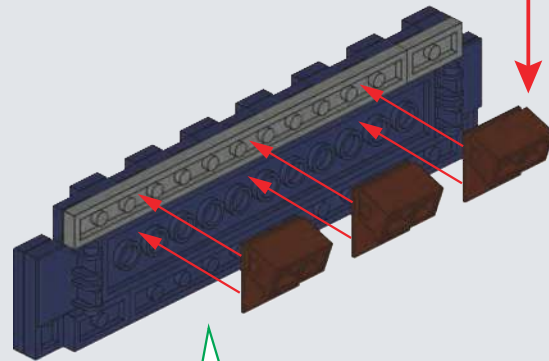
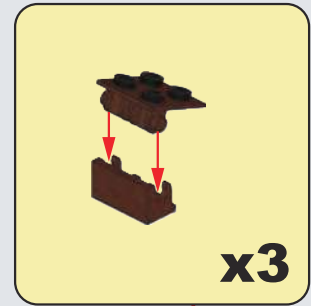
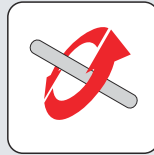

# B54

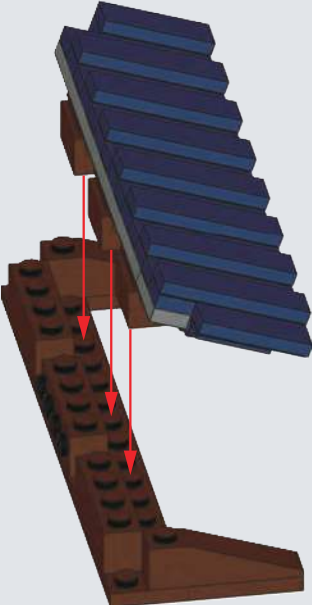

← **B46**

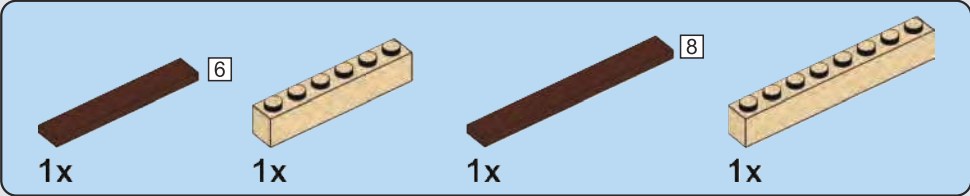
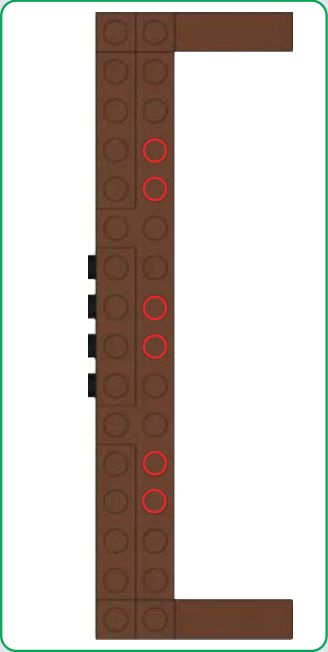

# B55

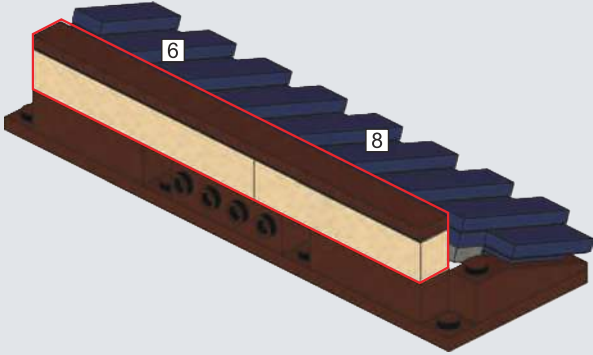

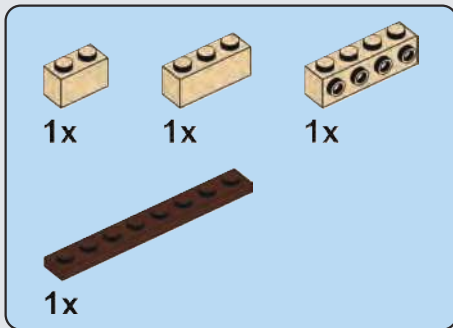

## B56

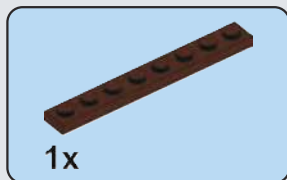
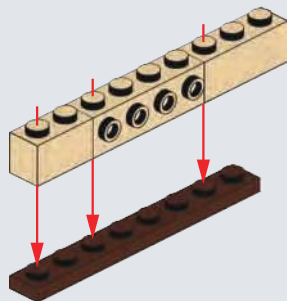

## B57

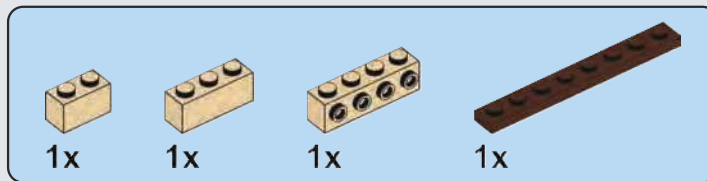
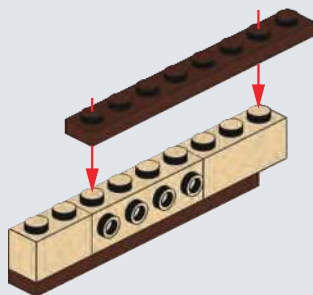

## B58

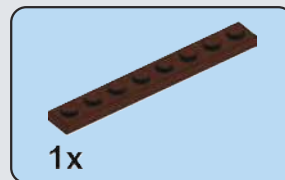
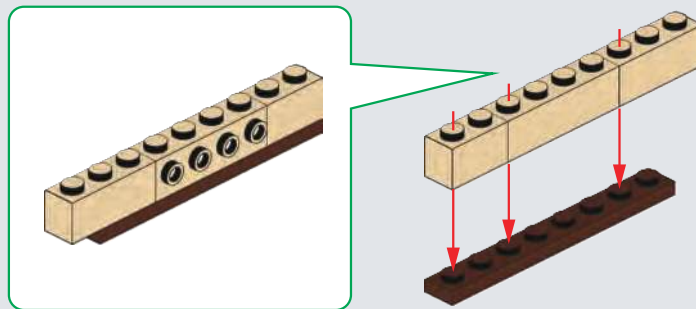

## B59

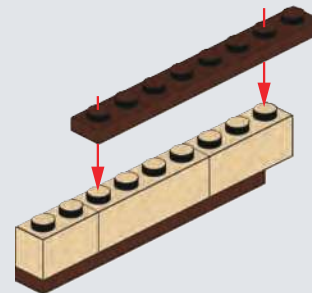

# B60

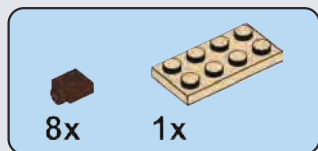
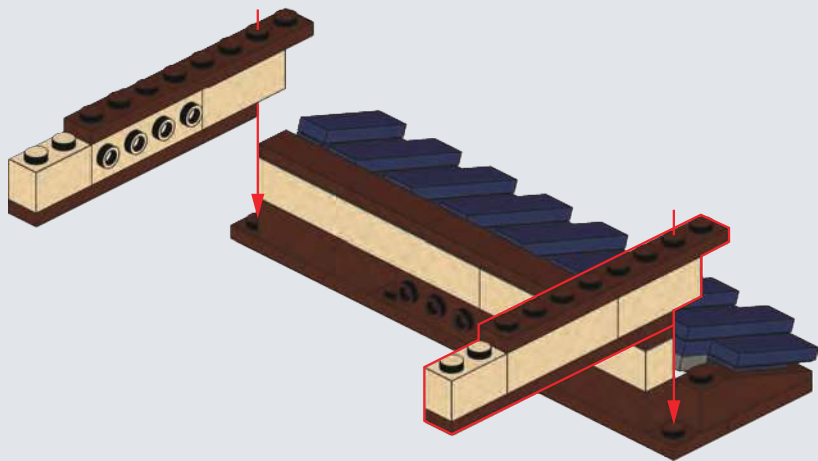

# B61

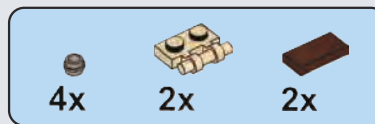
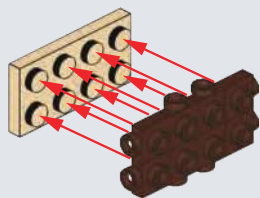

# B62

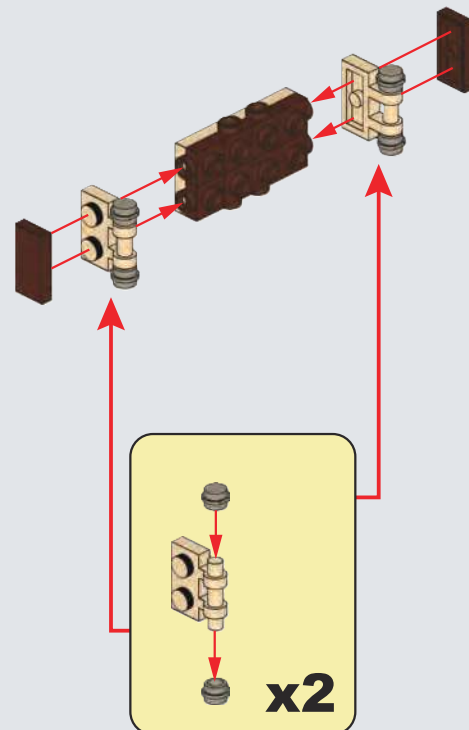

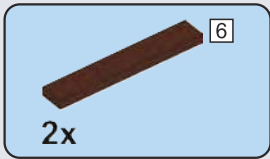

## B63

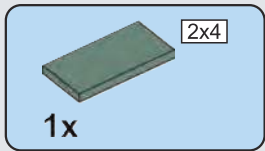
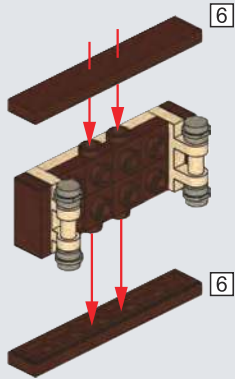

## B64

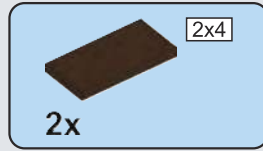
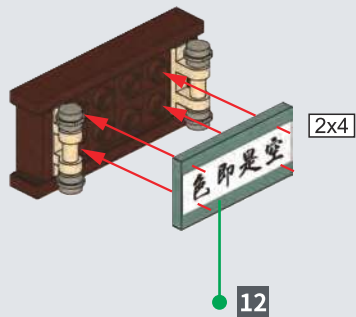

## B65

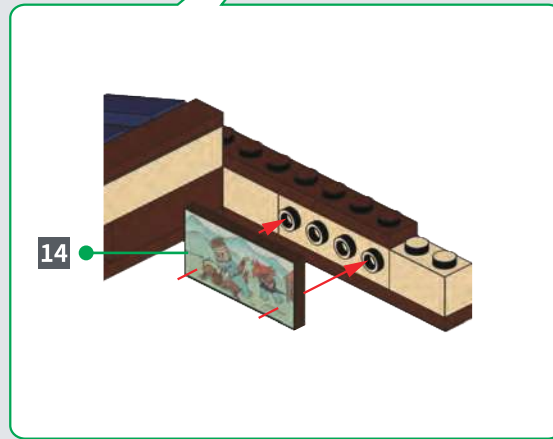
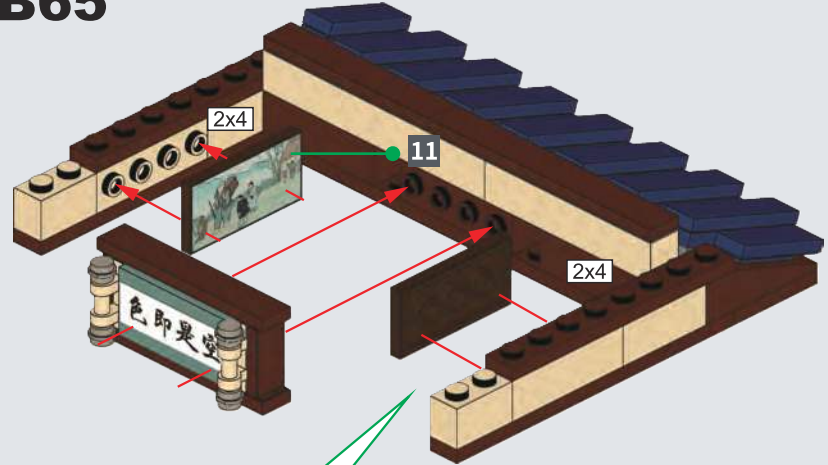
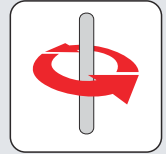

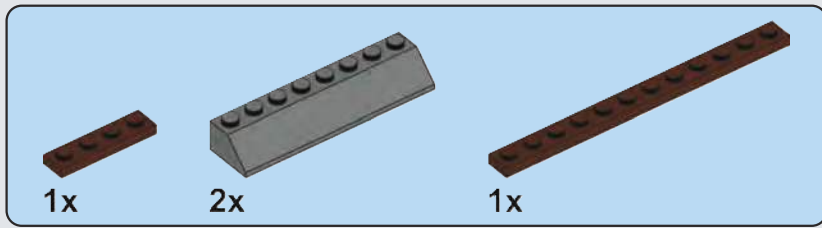

## B66

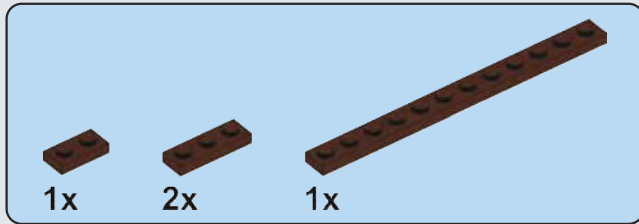
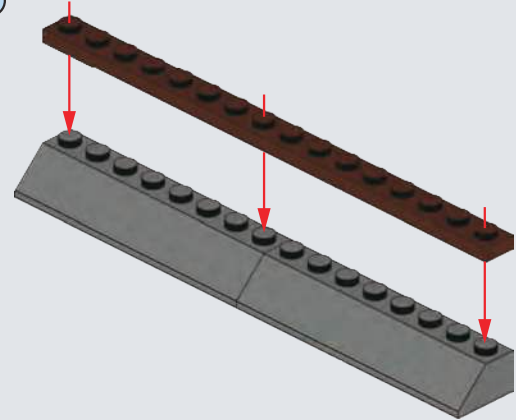

## B67

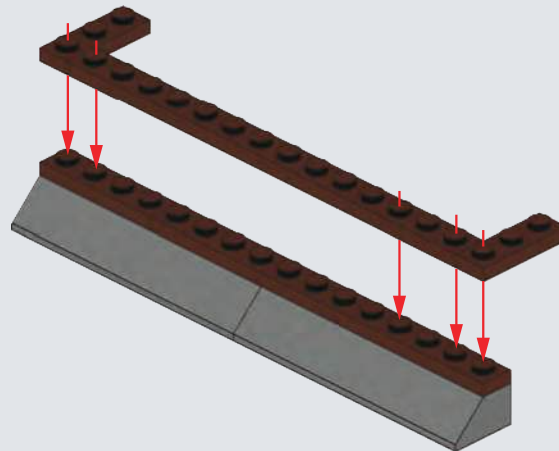

# B68

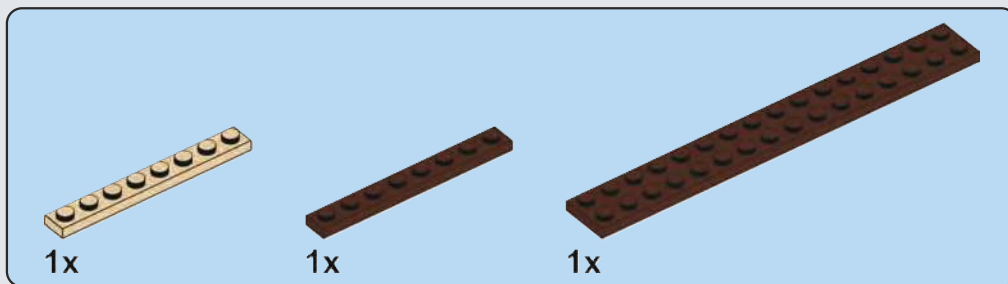
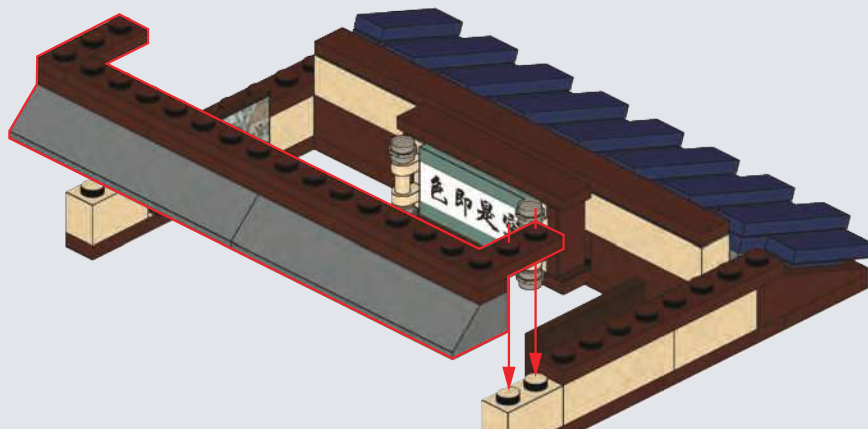

# B69

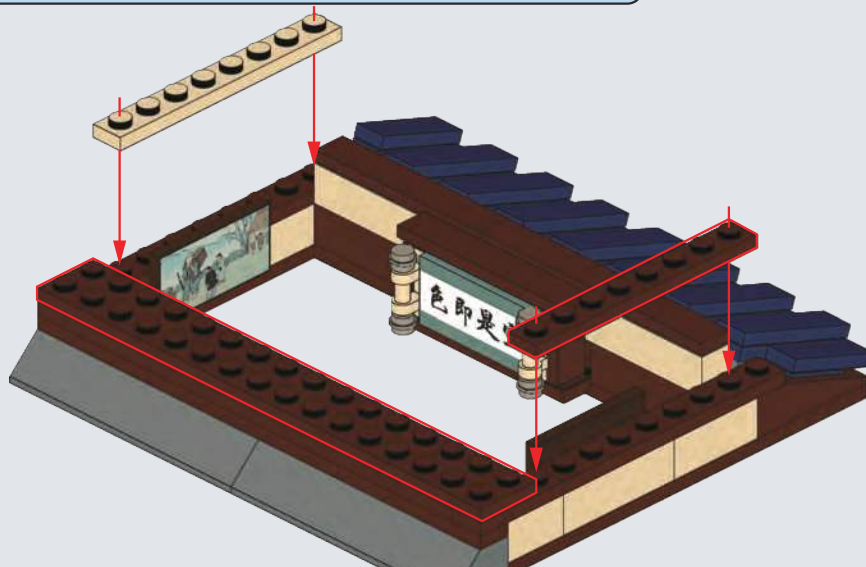

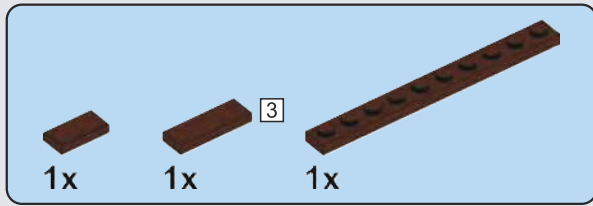

## B70

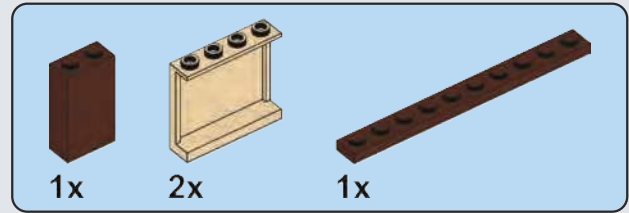
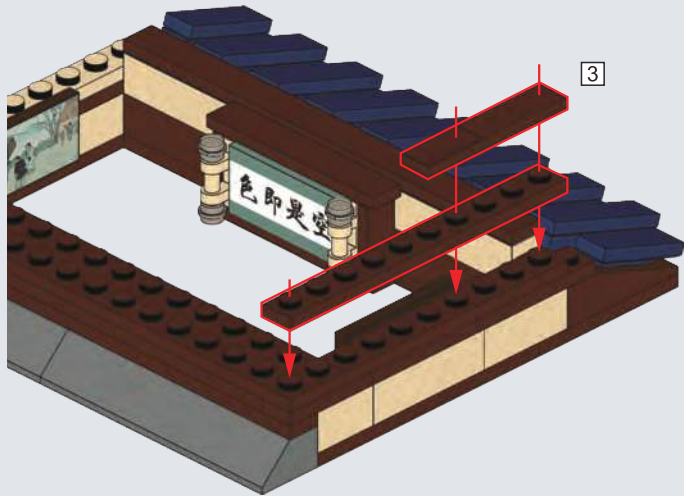

## B71

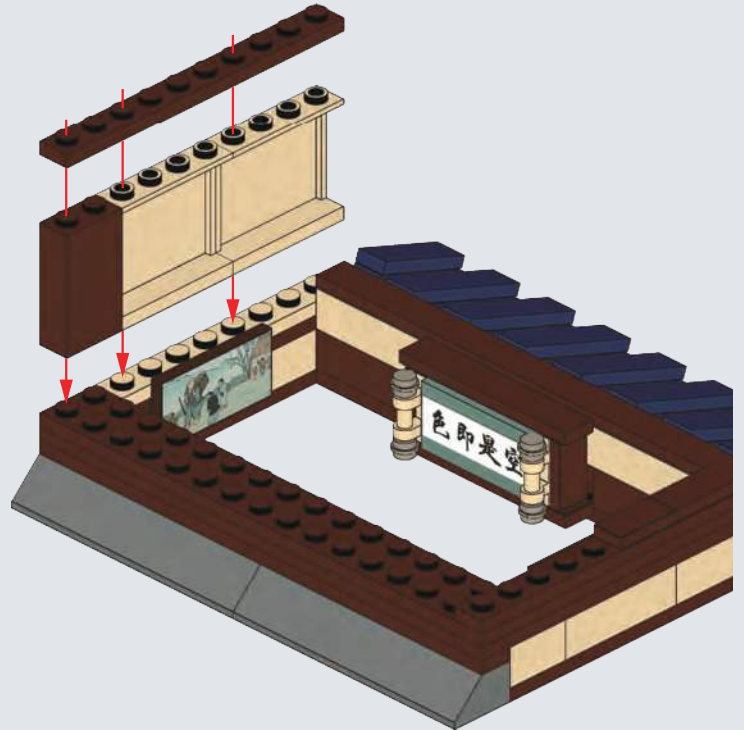

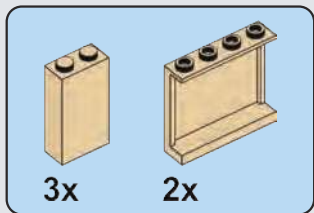

**B72**

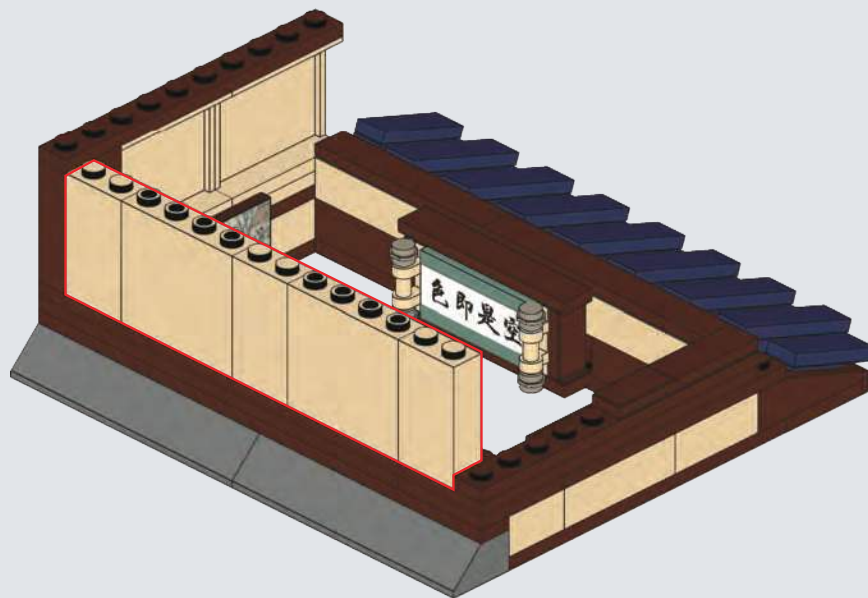

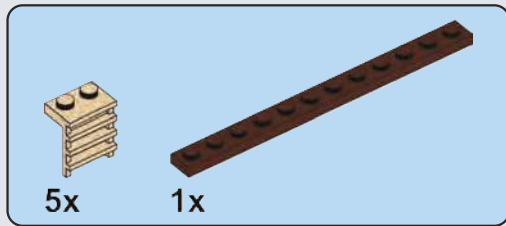

**B73**

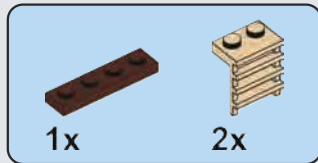
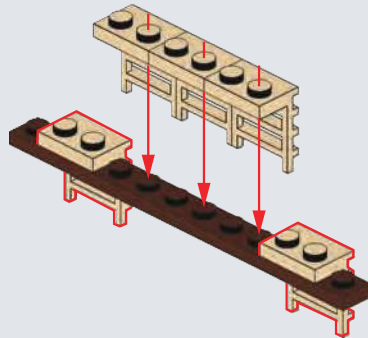

**B74**

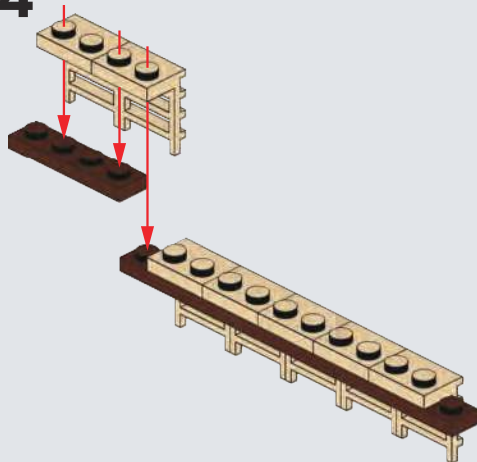

**B75**

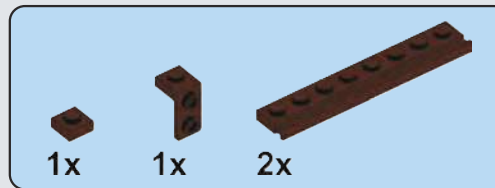
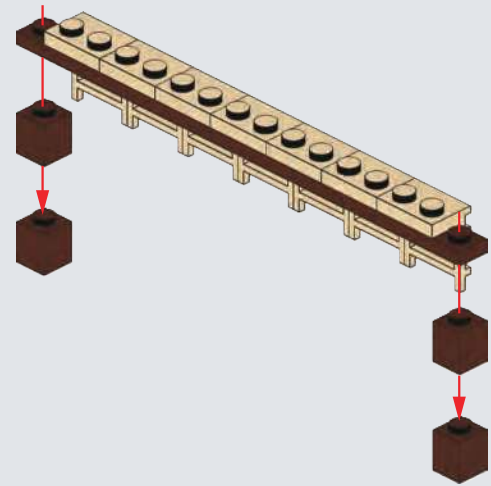

**B76**

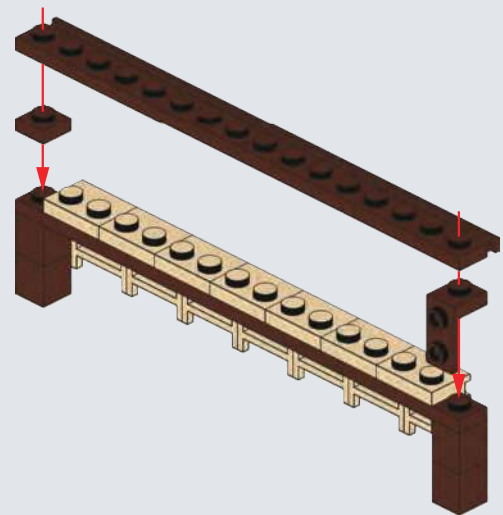



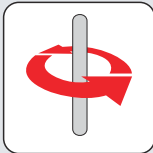
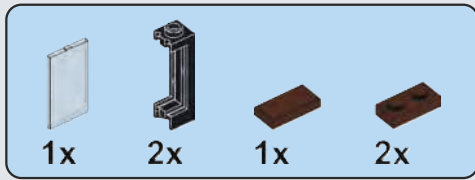

## B79

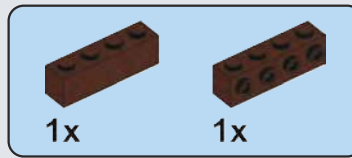
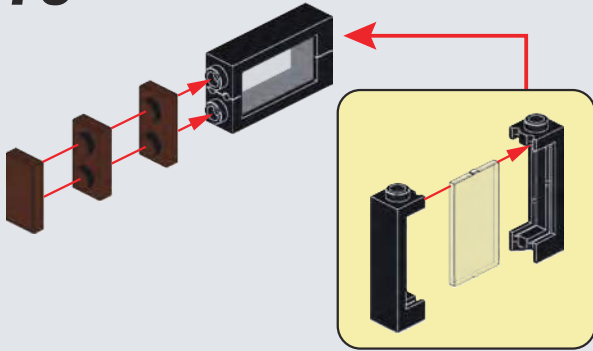

## B81

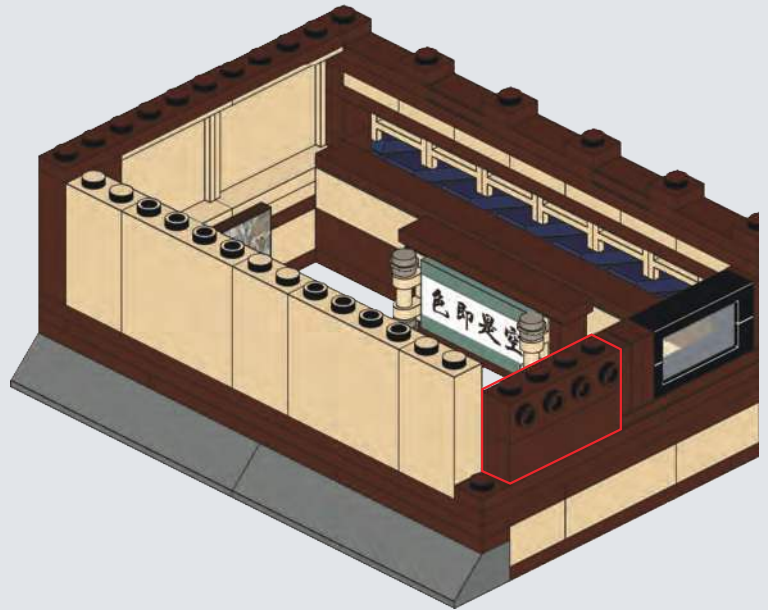

## B80

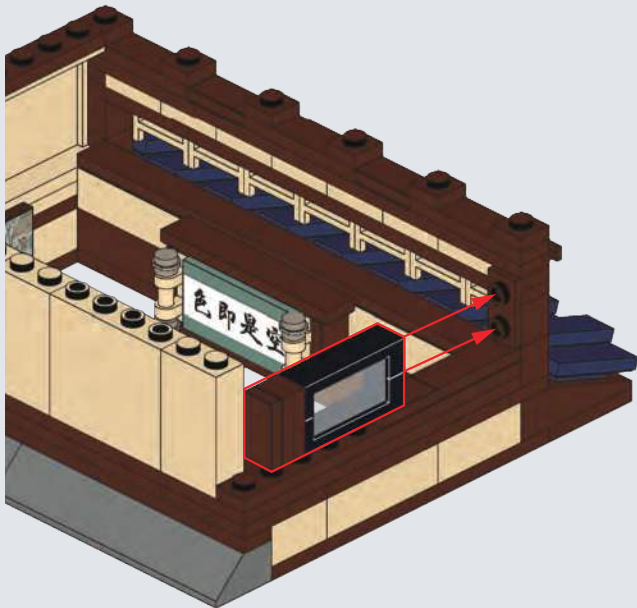

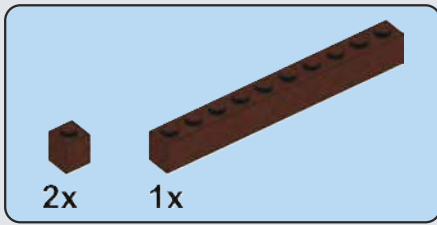

# B82

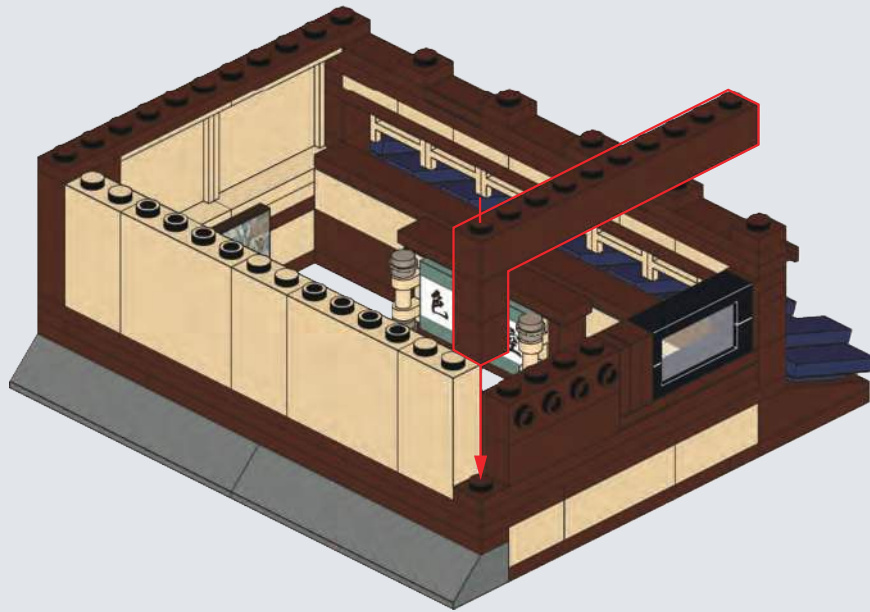

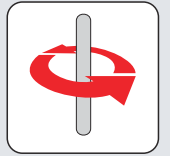

# B83

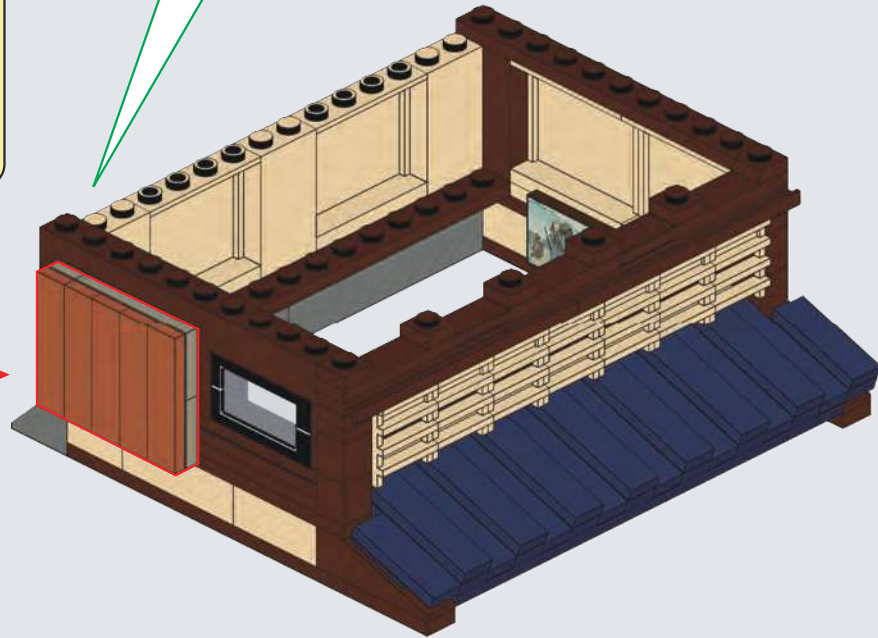
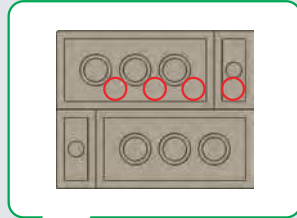
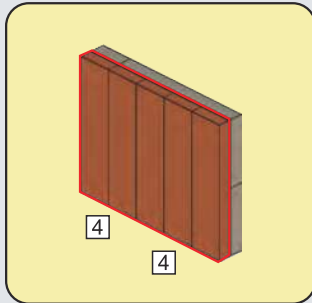

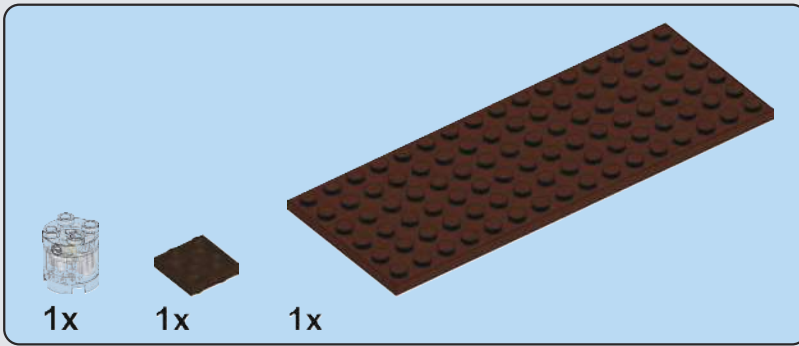

## B84

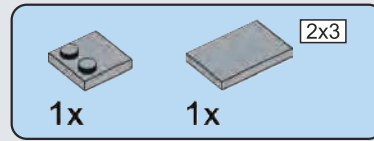
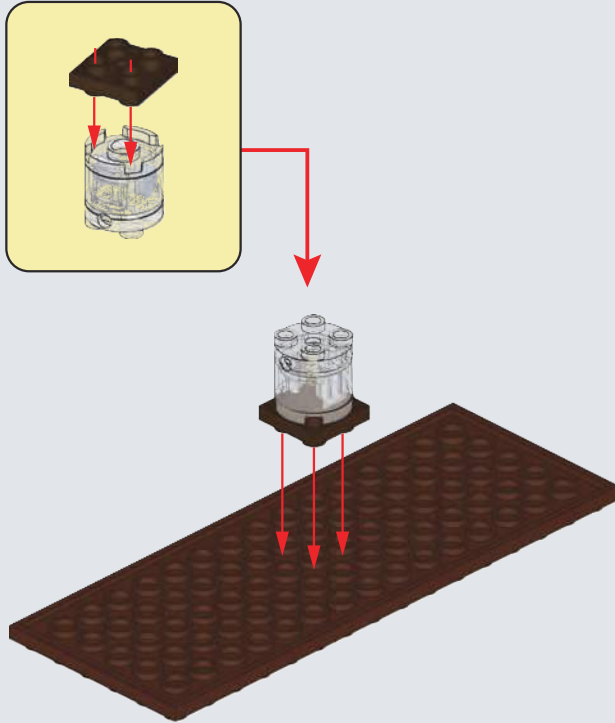

## B85

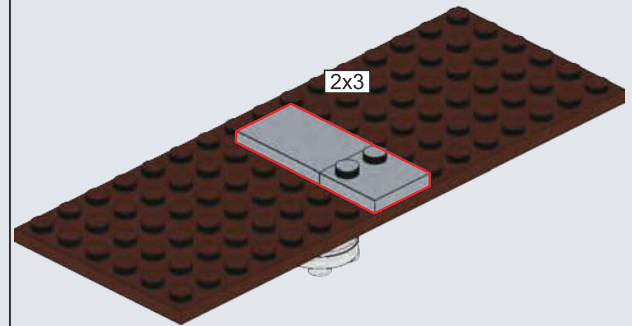
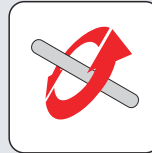

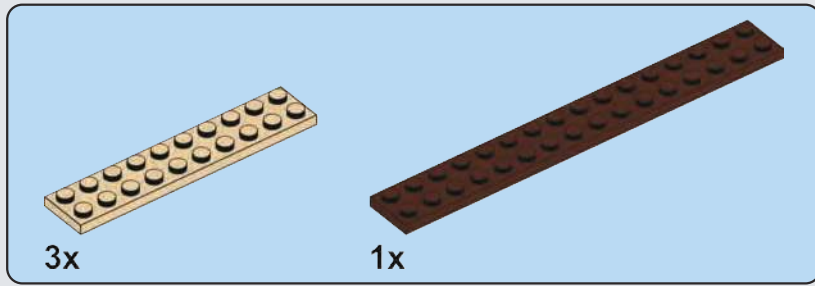

## B86

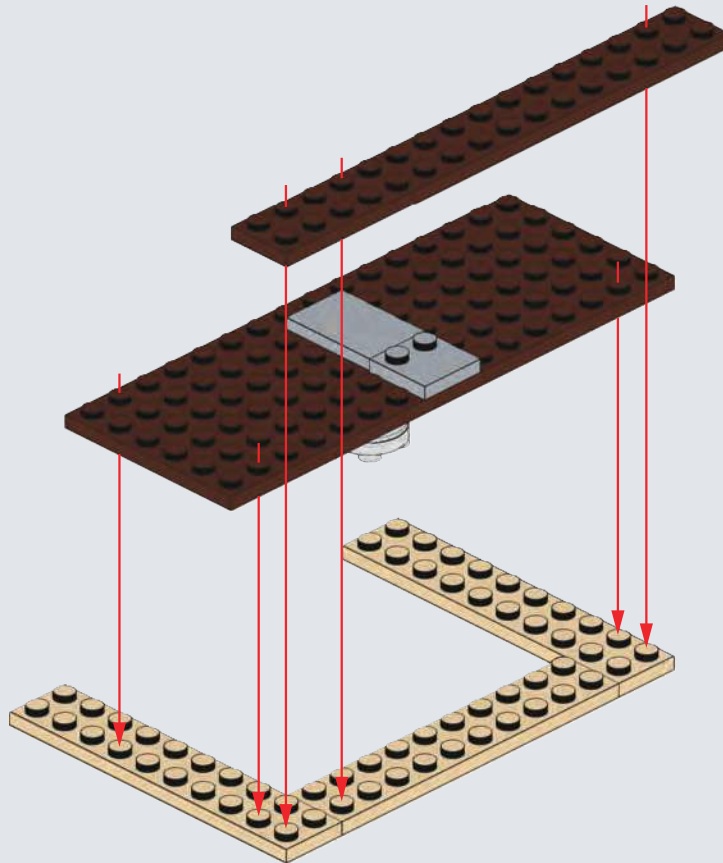

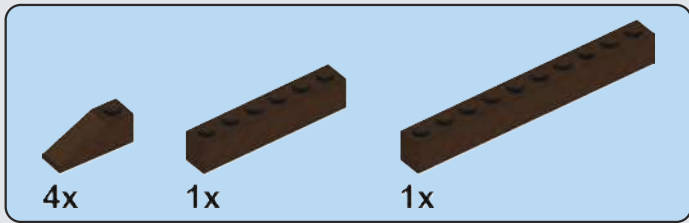

## B87

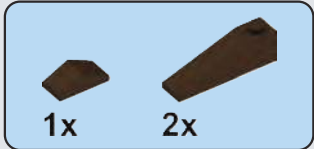
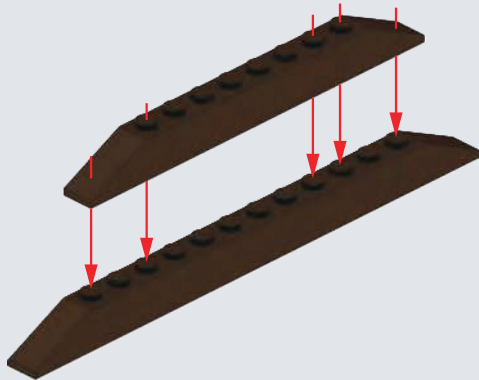

## B88

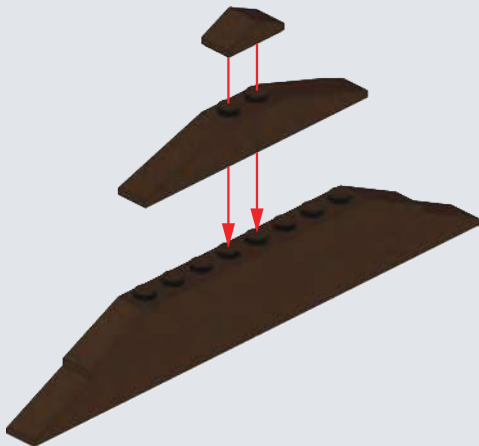

## B89

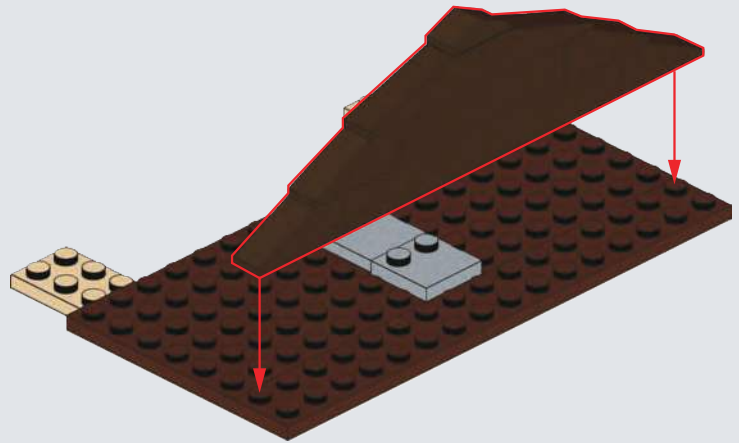

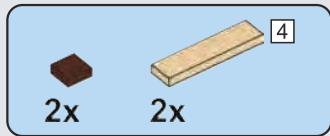

## B90

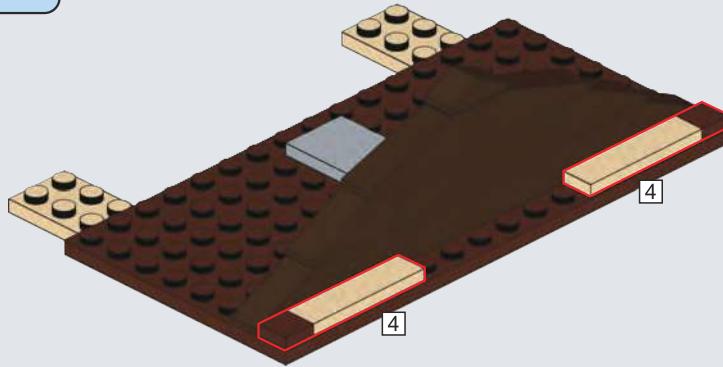

## B91

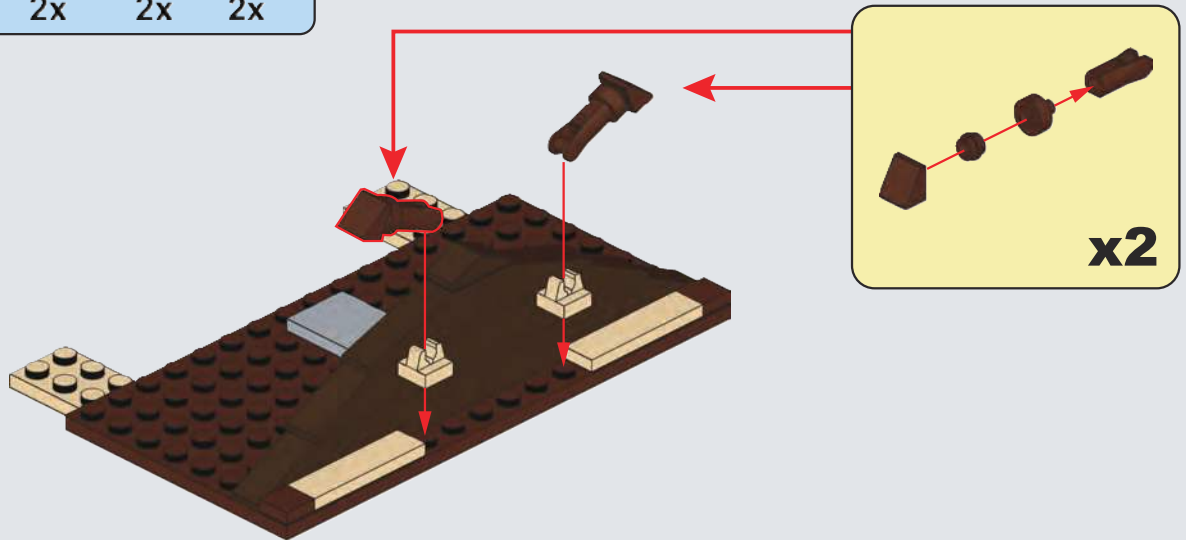

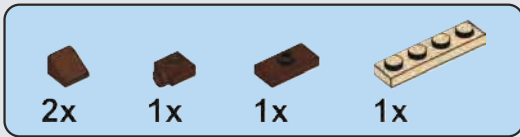

## B92

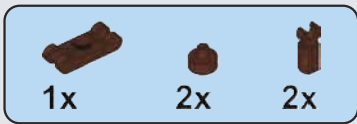
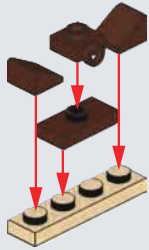

## B93

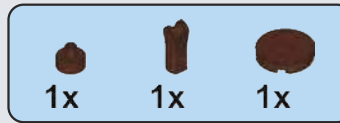
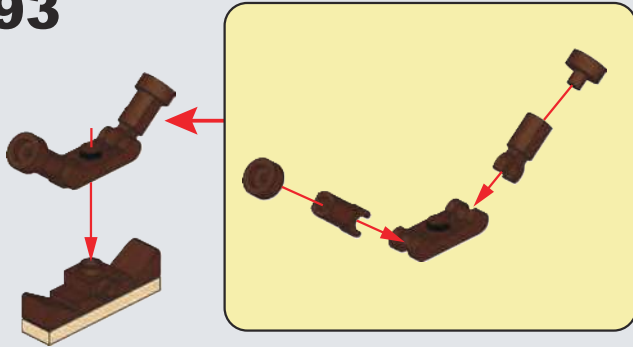

## B94

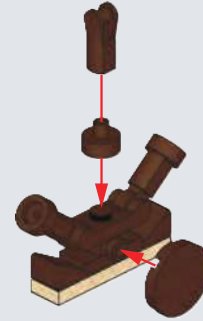

## B95

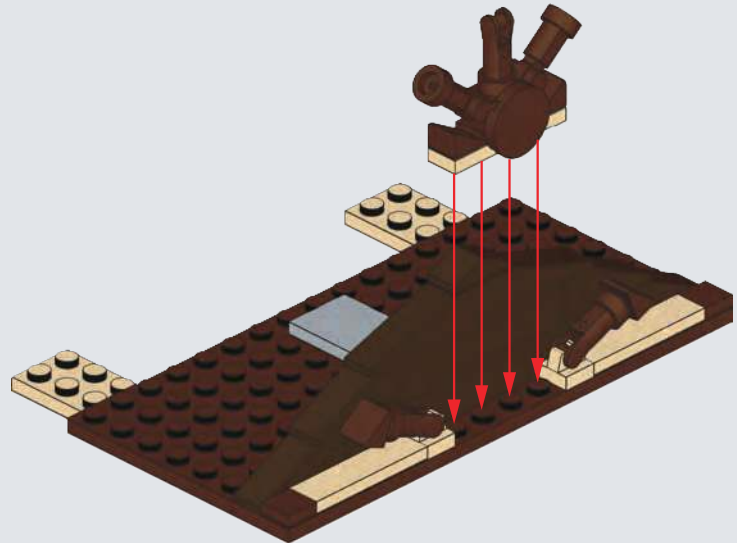

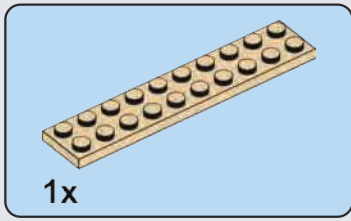

**B96**

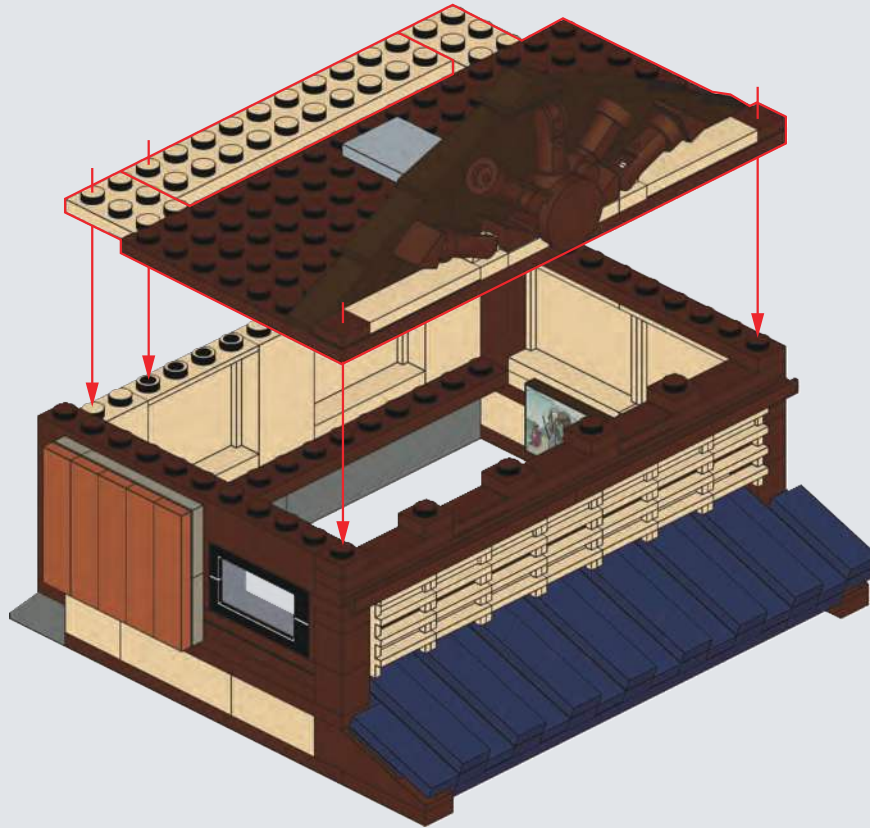

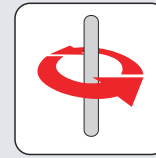
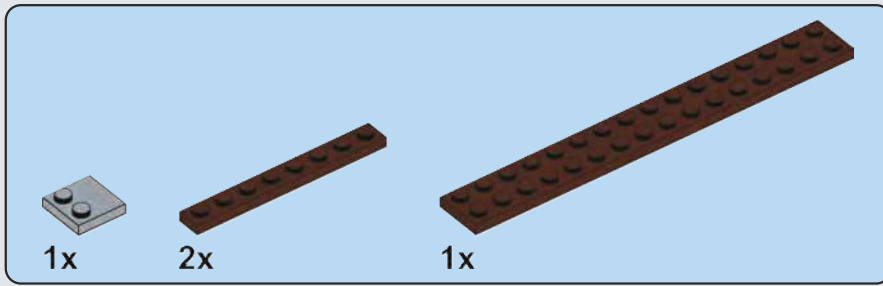

**B97**

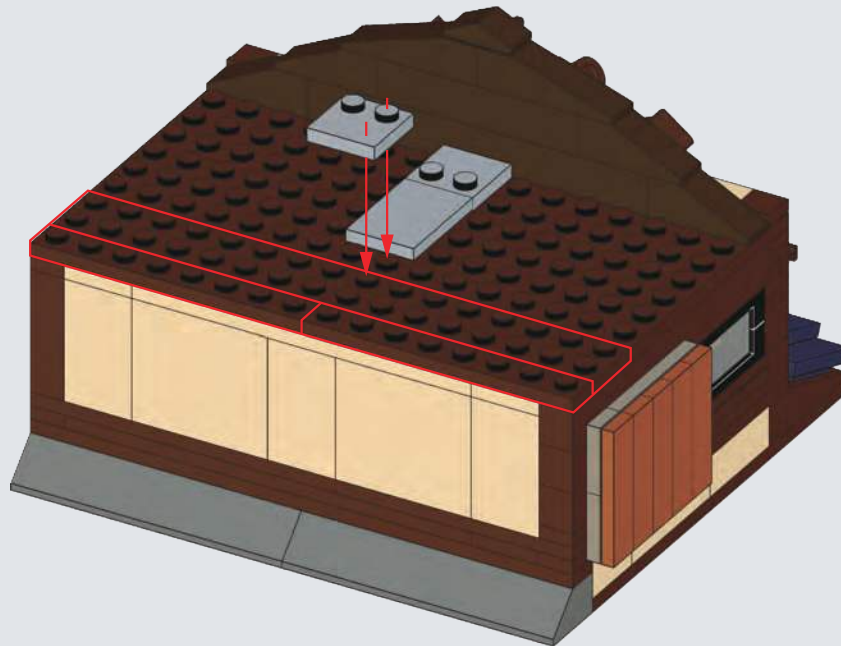

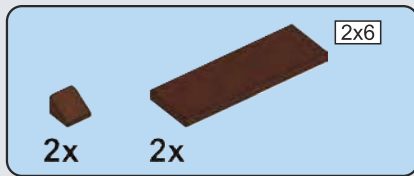

## B98

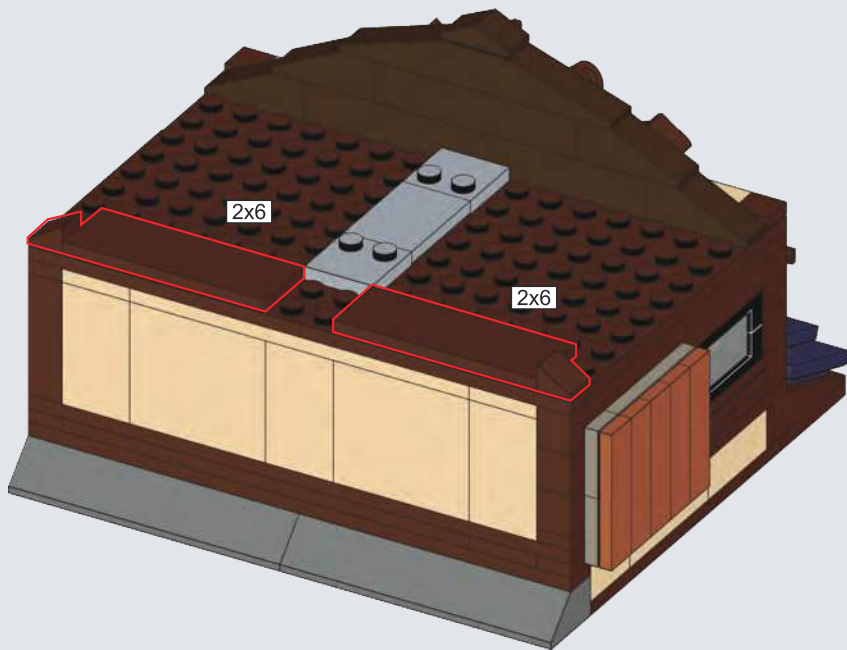

## B99

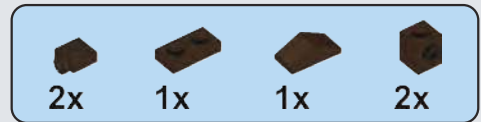

## B100



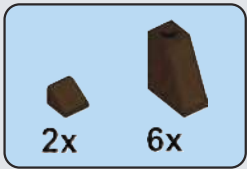

## B101

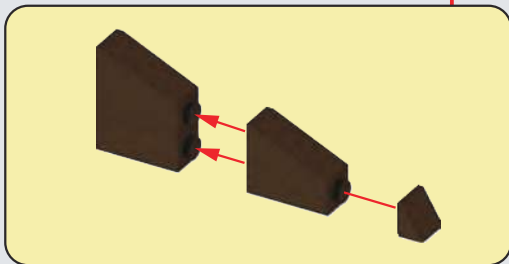
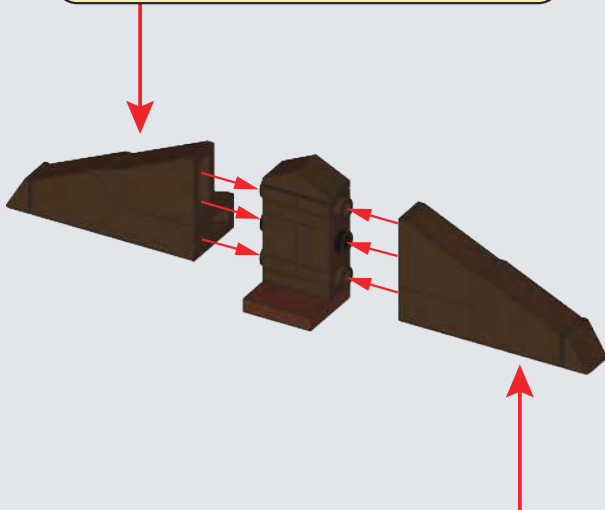
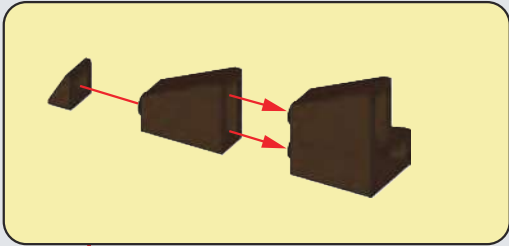

## B102

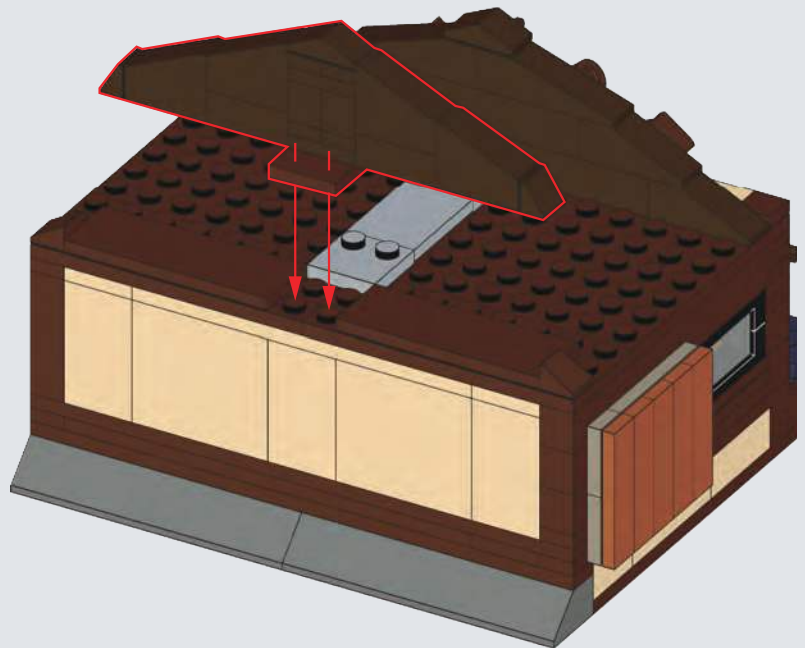



## B103

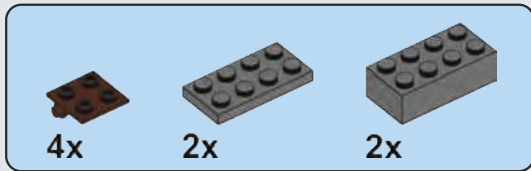
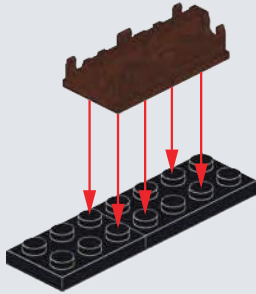

## B104

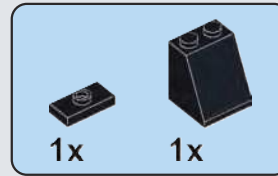
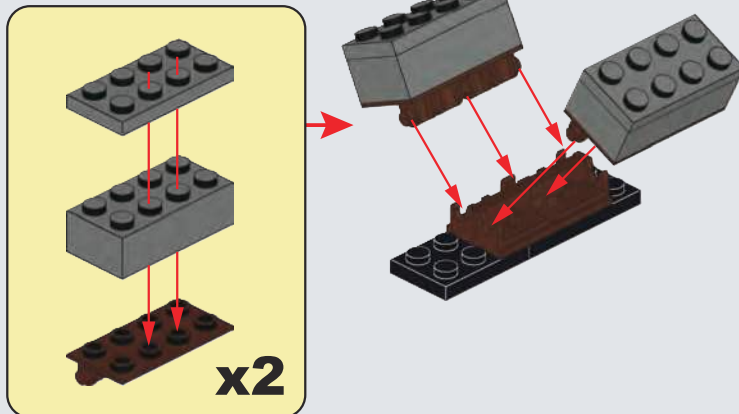

## B105

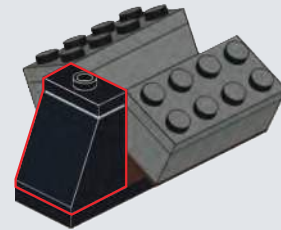

## B106

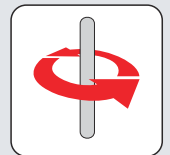
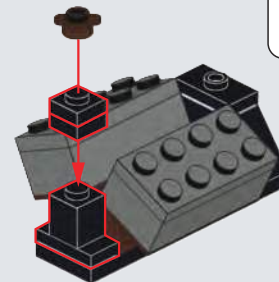

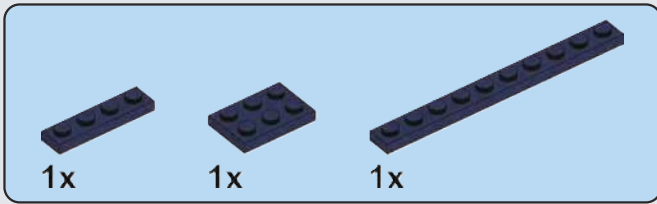

## B107

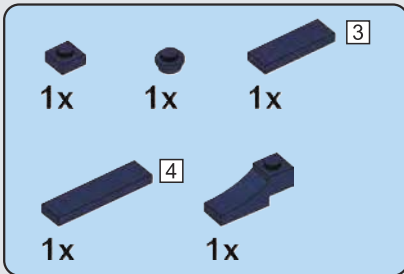
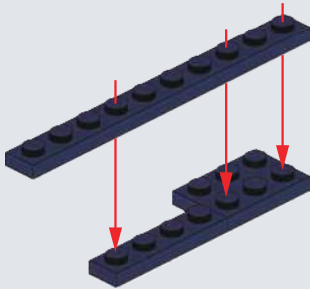

## B108

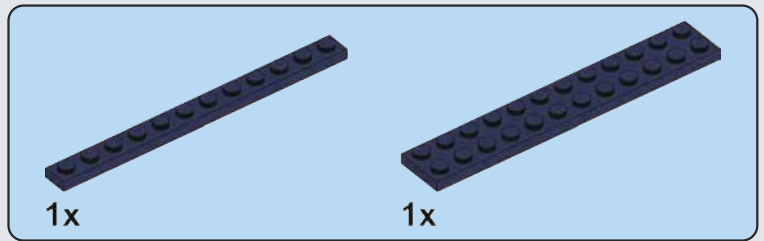
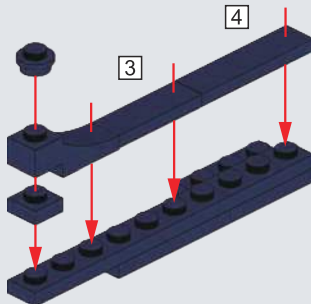

## B109

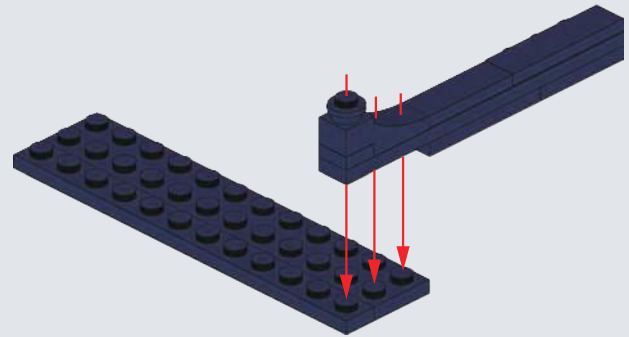

## B110

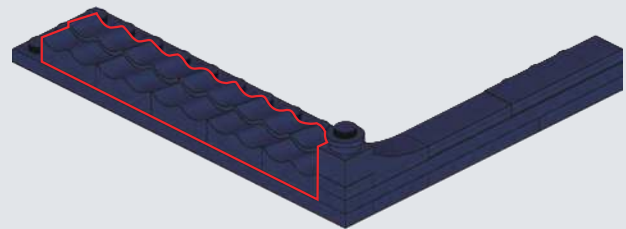

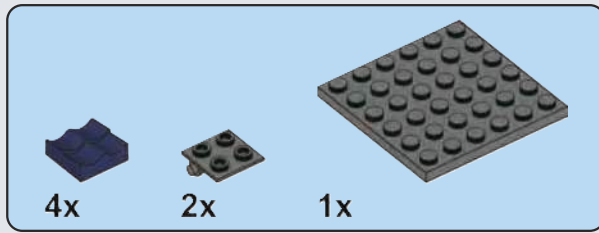

## B111

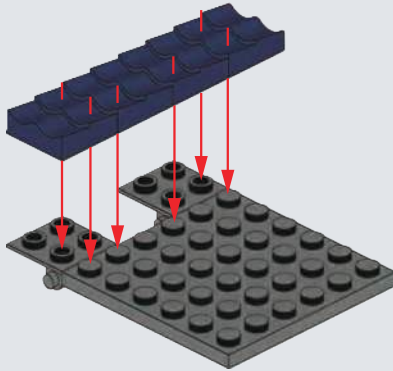

## B112

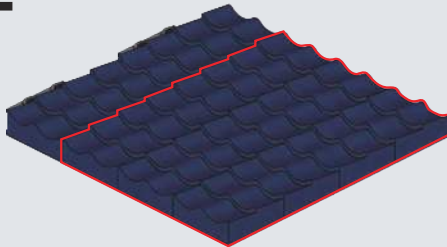

## B113

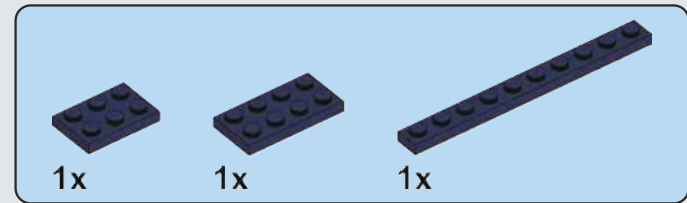
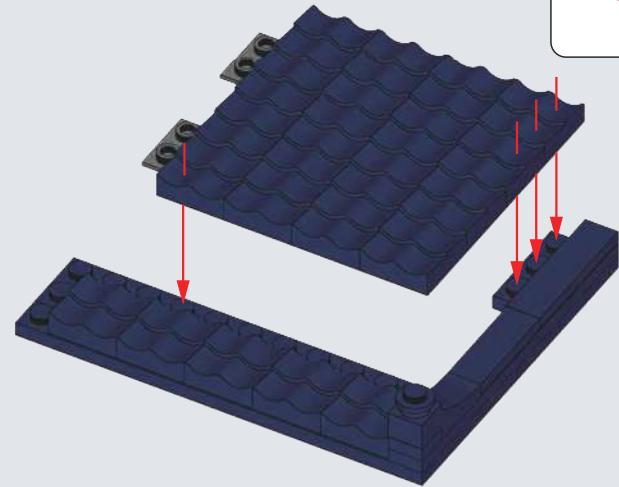
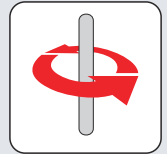

## B114

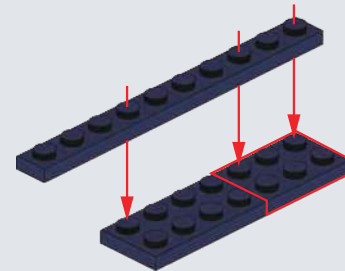

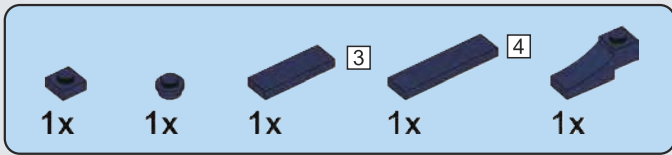

## B115

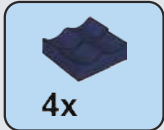
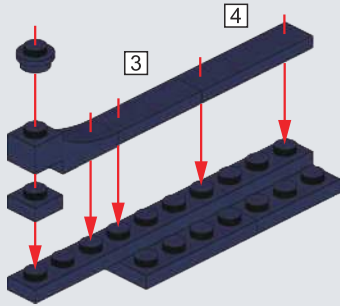

## B116

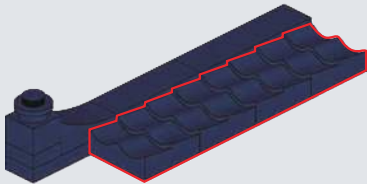

## B117

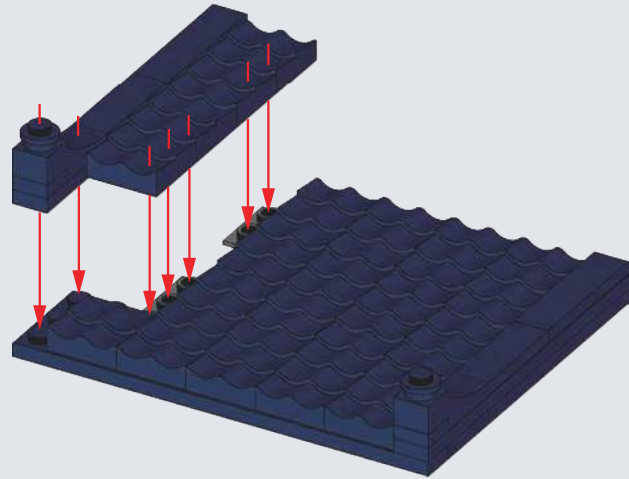

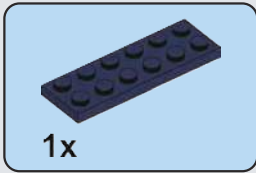

**B118**

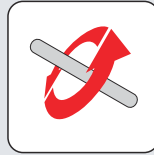
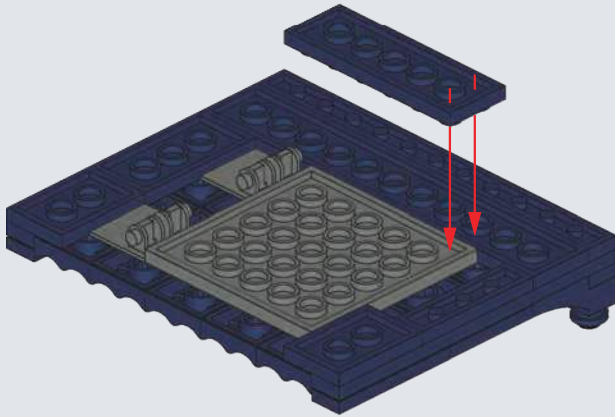

**B119**

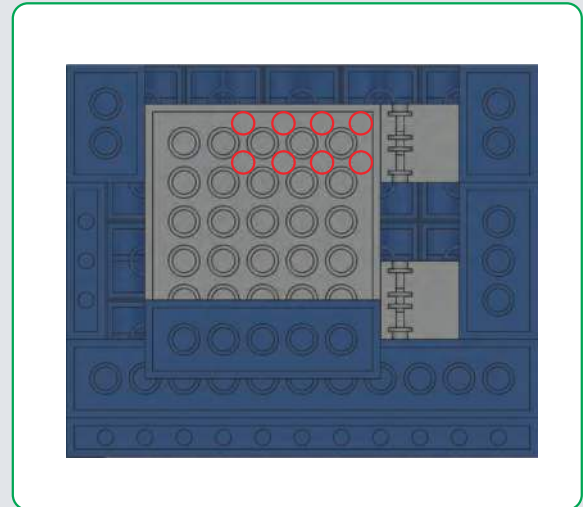
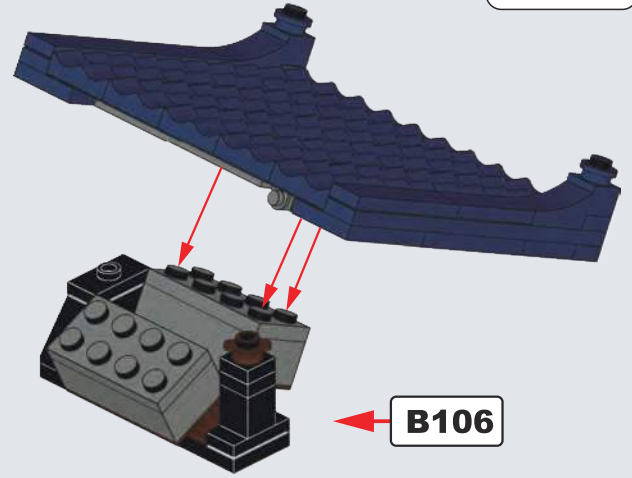

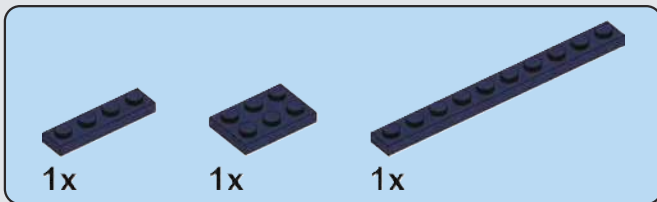

## B120

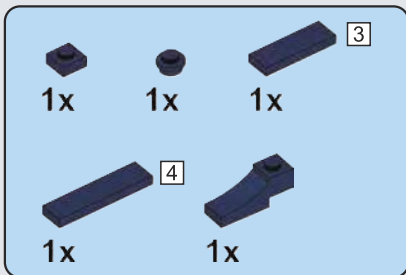
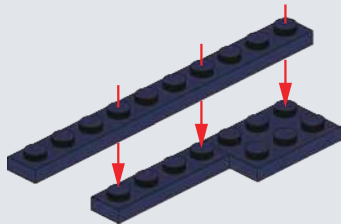

## B121

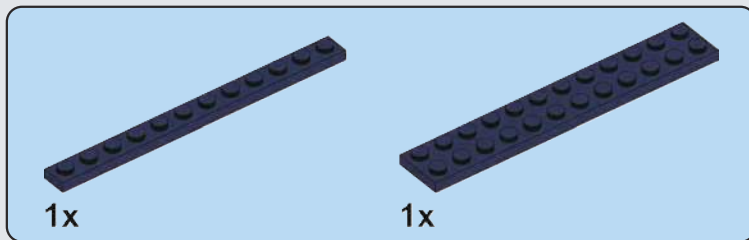
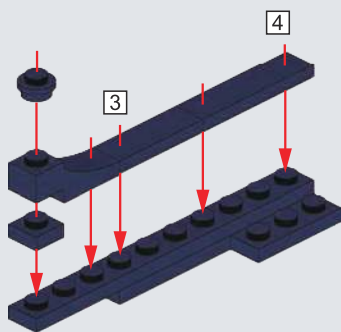

## B122

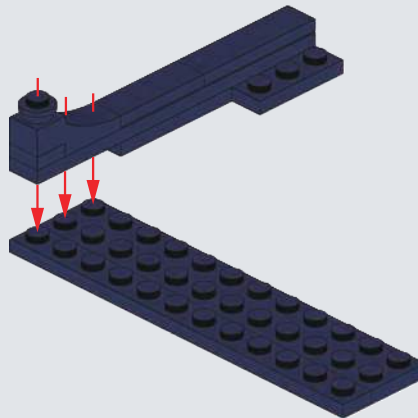

## B123

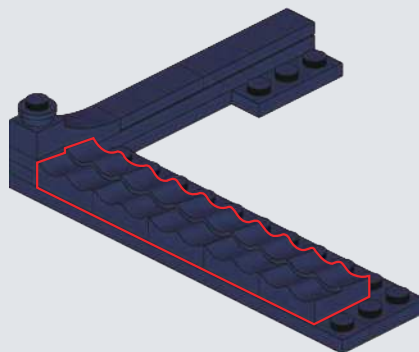

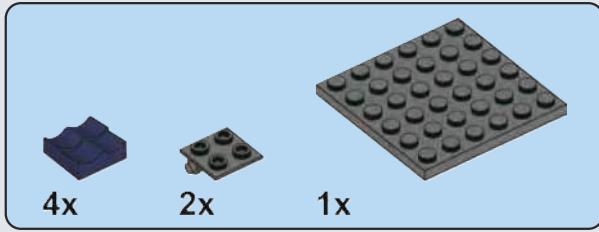

## B124

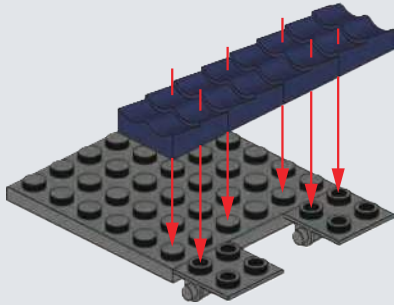

## B125

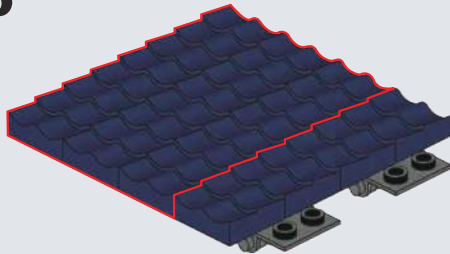

## B126

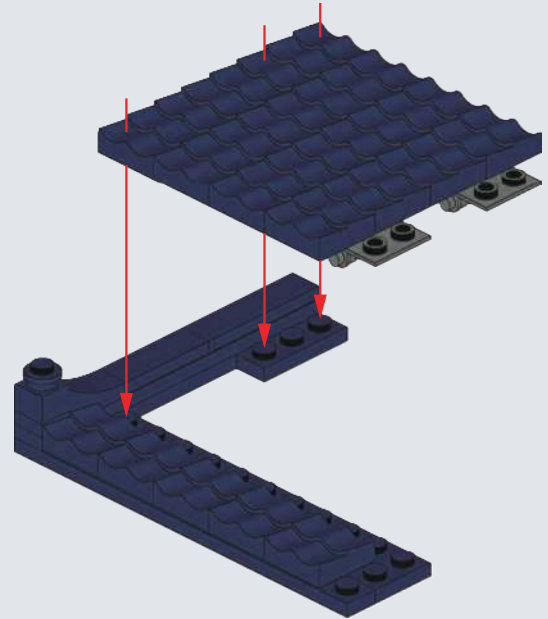

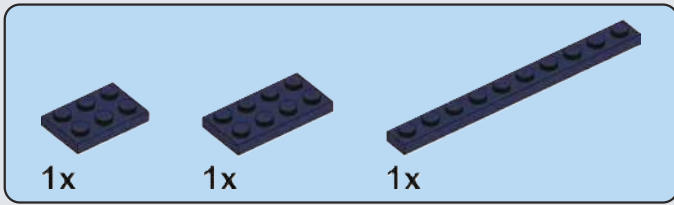

## B127

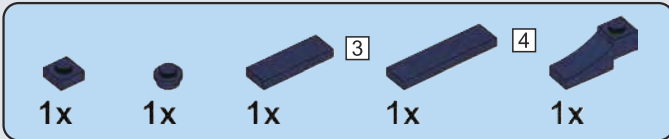
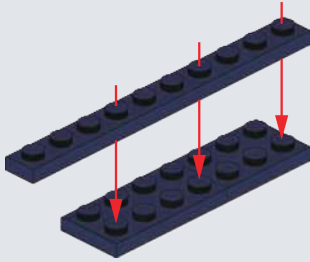

## B128

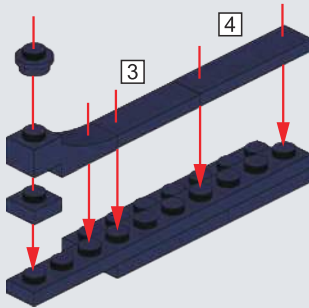

## B129

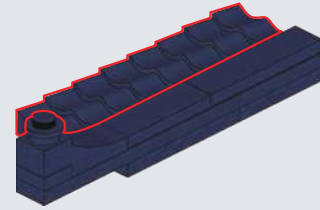

## B130

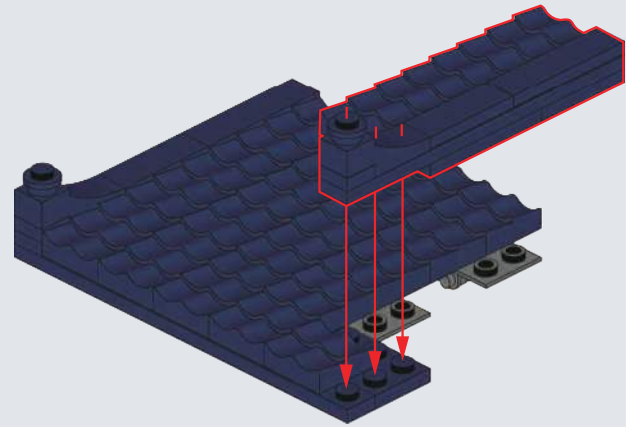

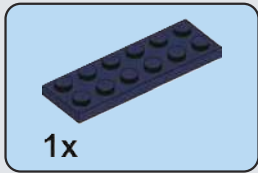

**B131**

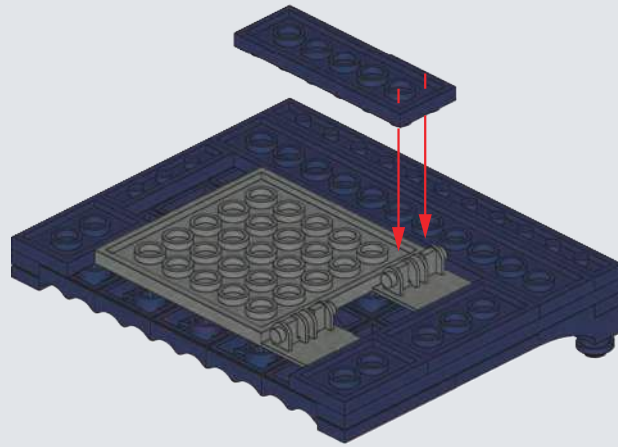

**B132**

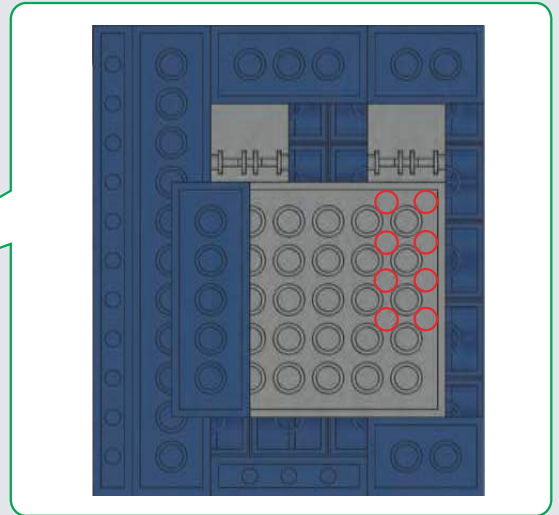
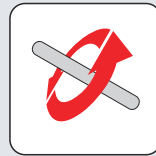
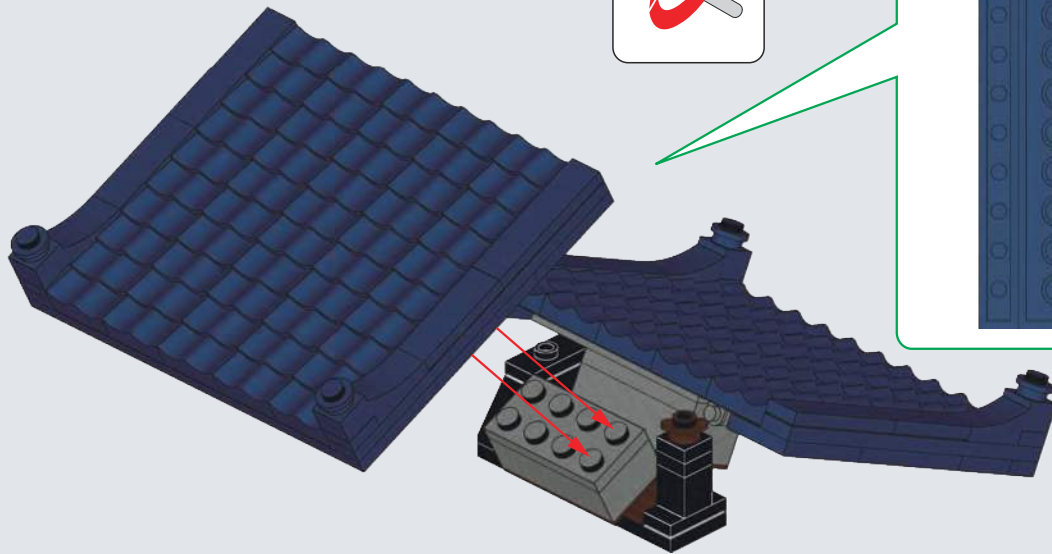



## B133

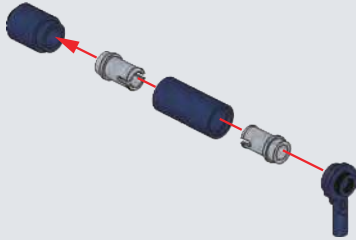

## B134

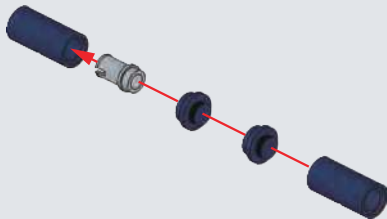

## B135

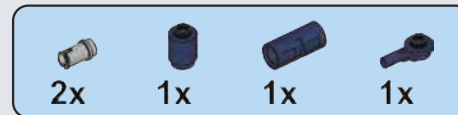
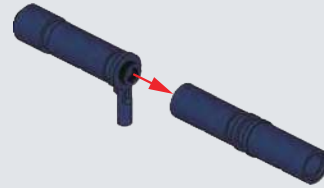

## B136

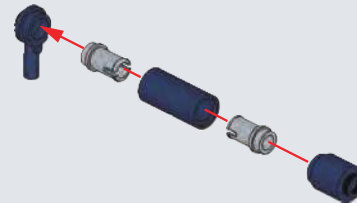

**B137**

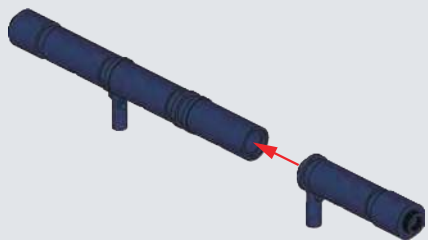

**B138**

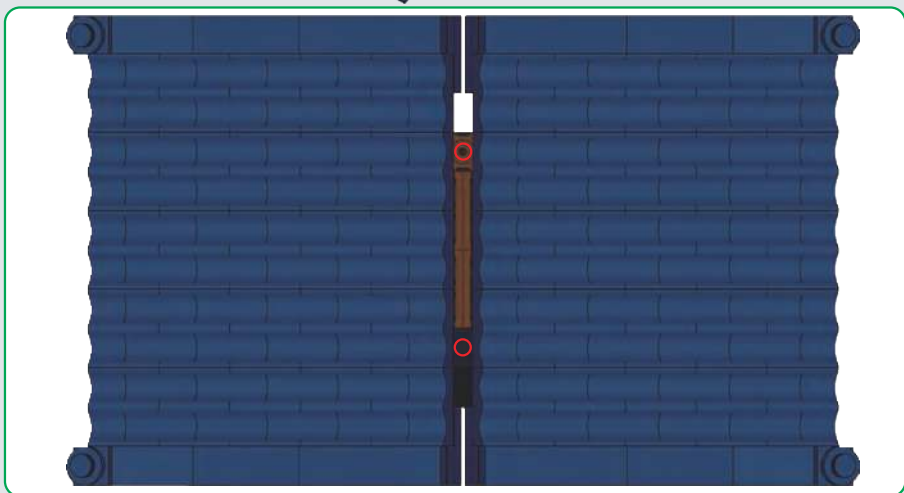
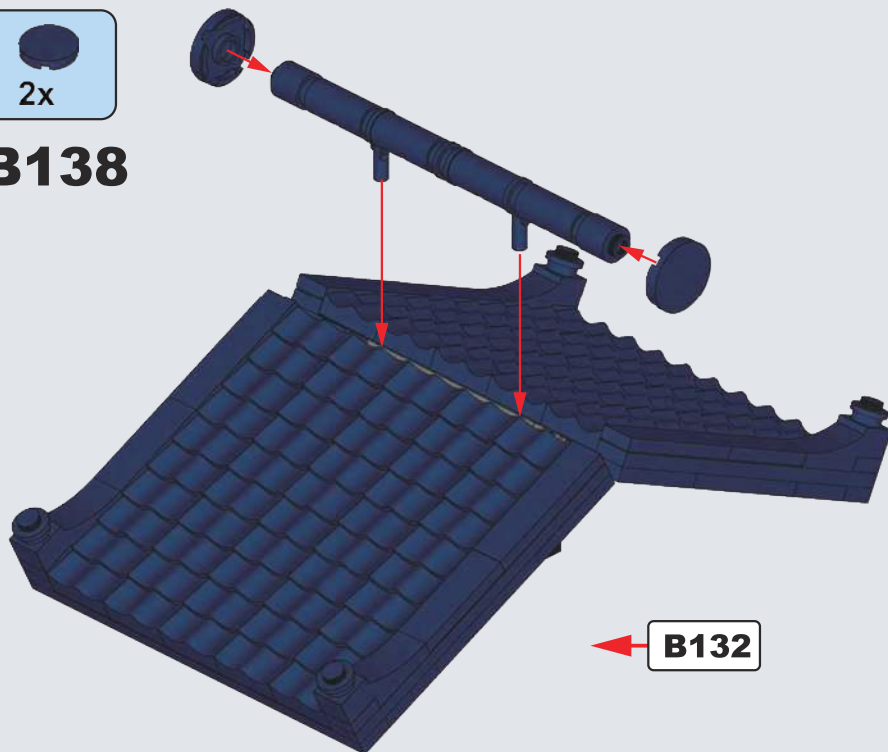

**B139**

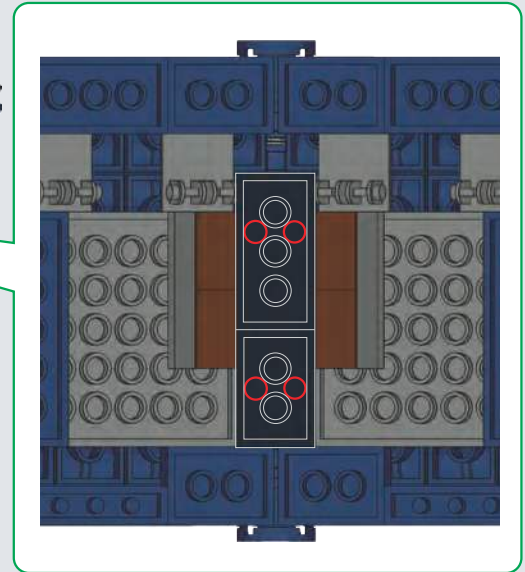
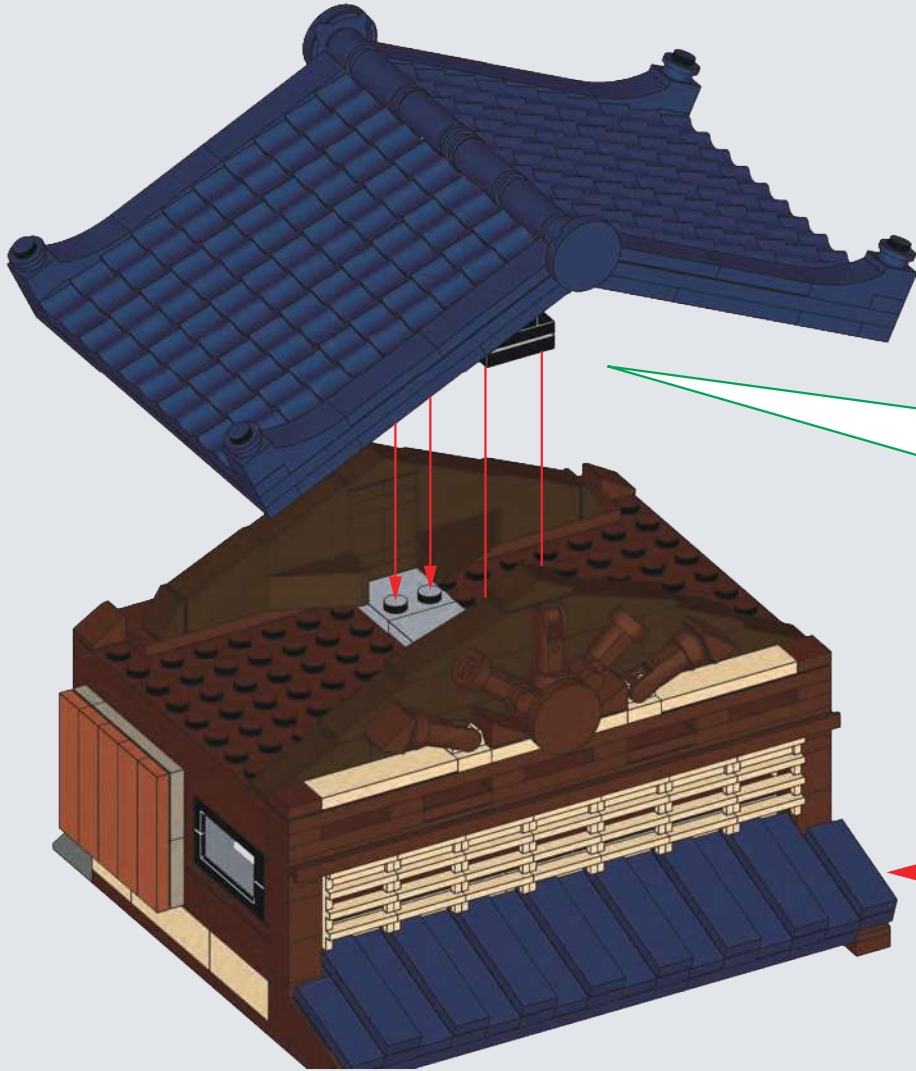
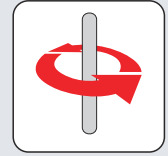

**B102**

**B140**

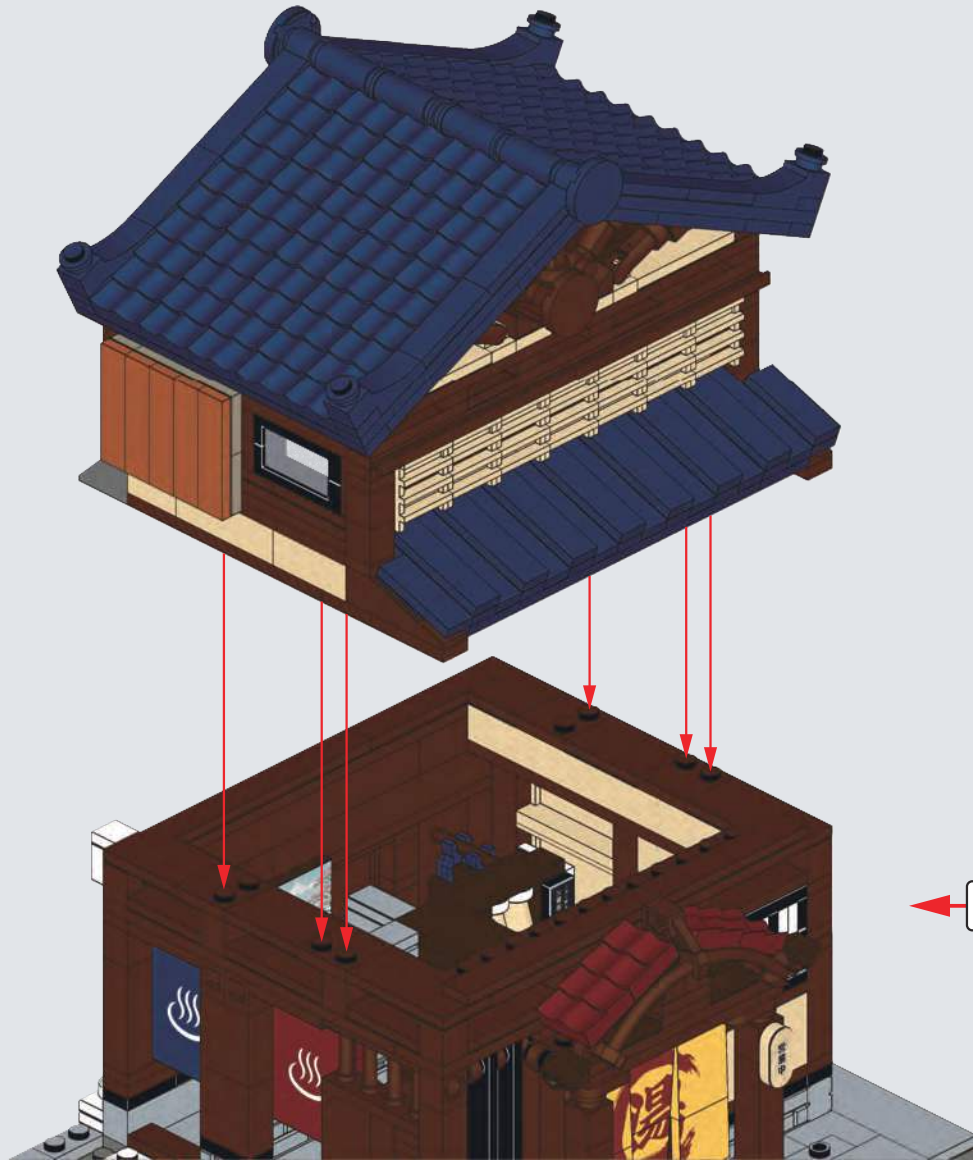

**B44**

**C**

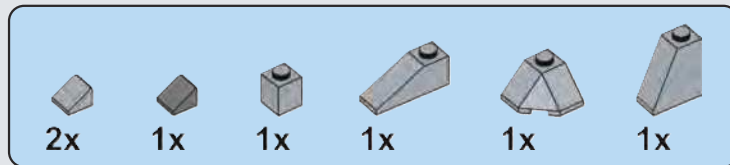
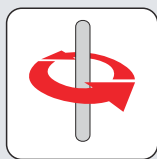

**C1**

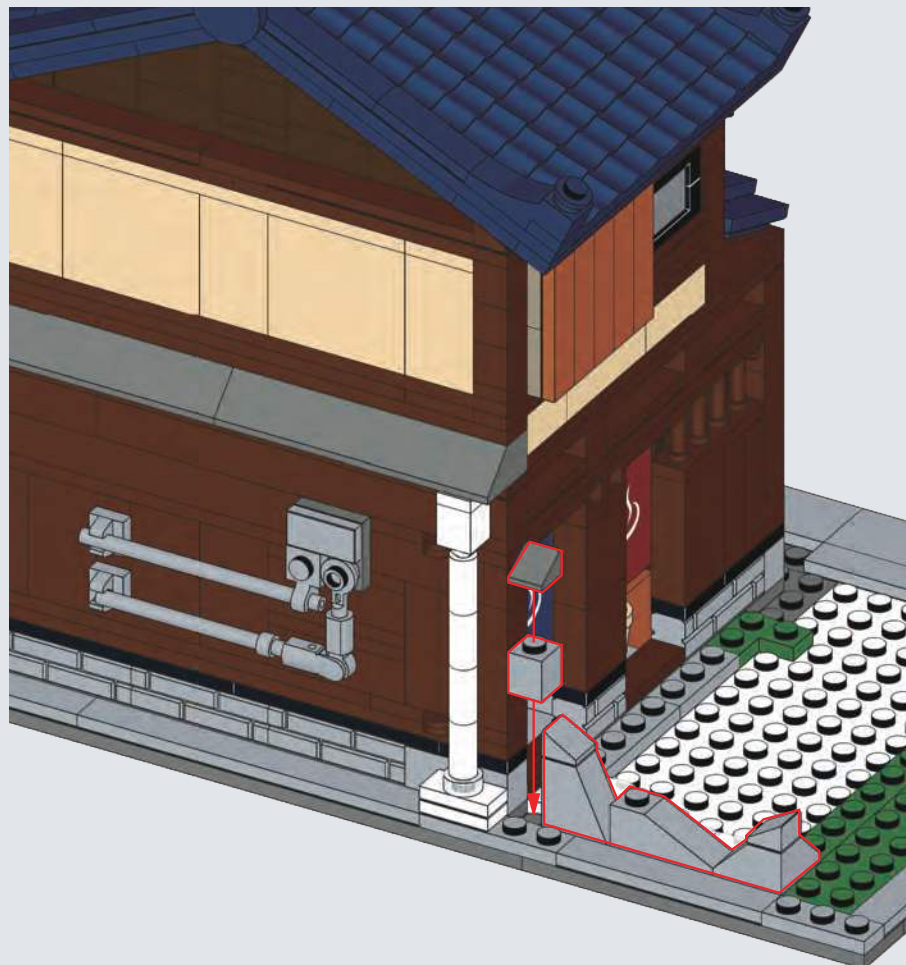

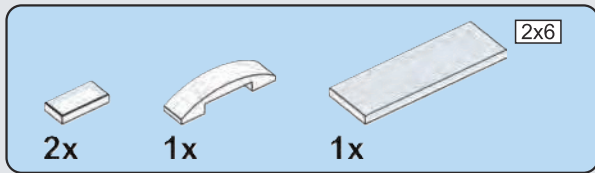

**C2**



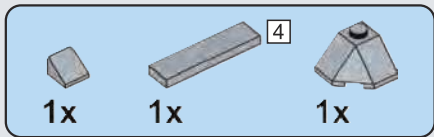

**C3**



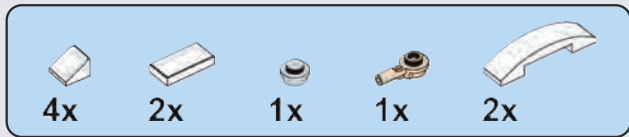

# C4



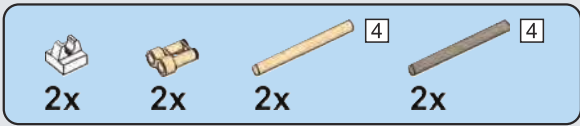

**C5**

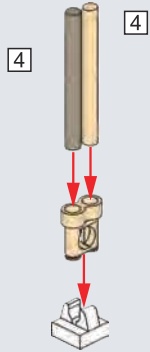

**x2**

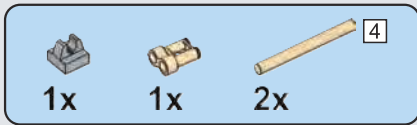

**C6**

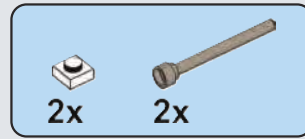
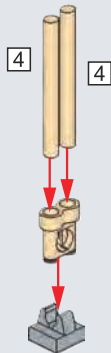

**C7**



**x2**

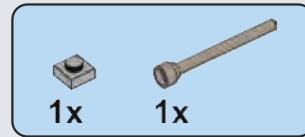

**C8**





1x

**C9**

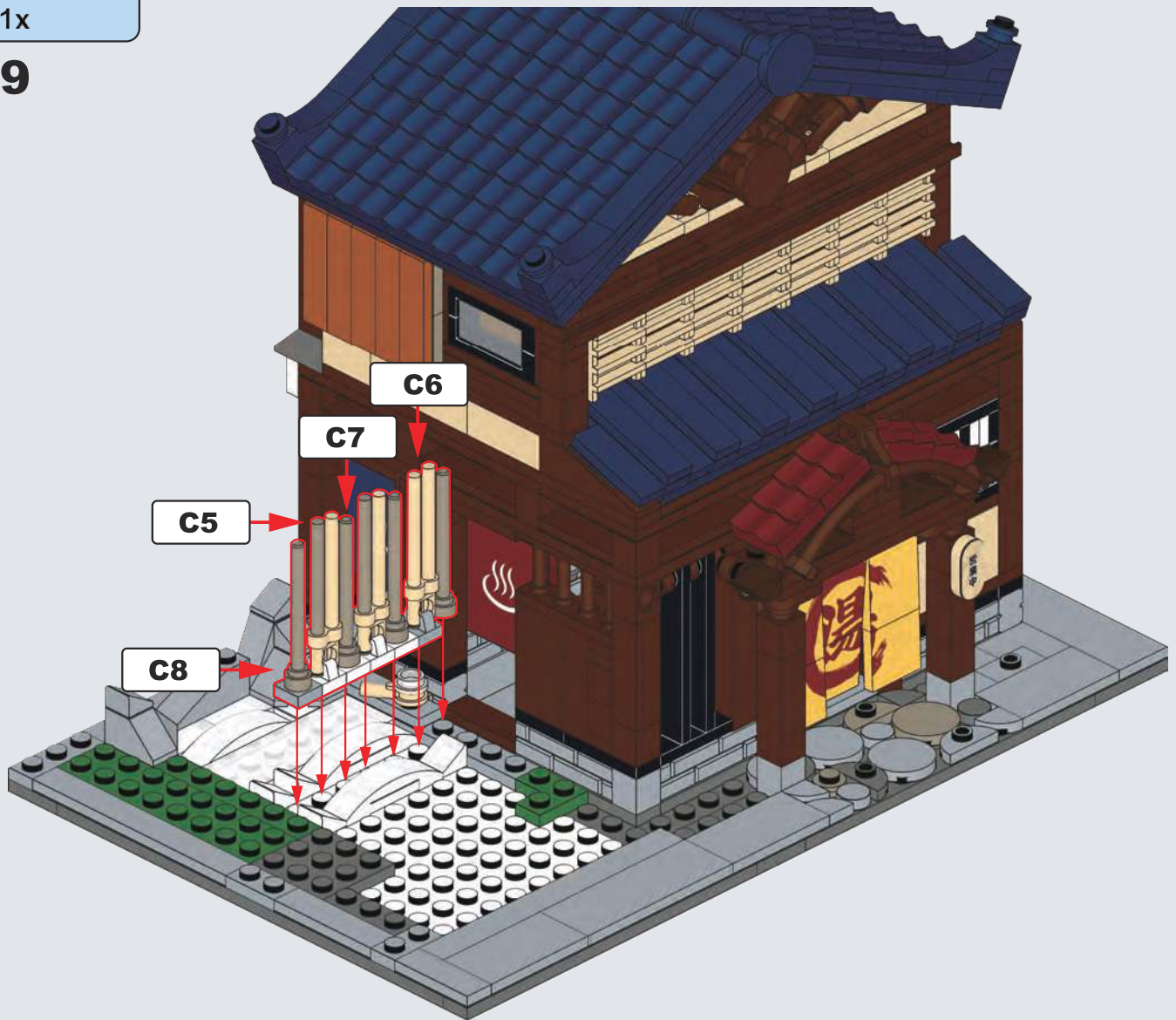

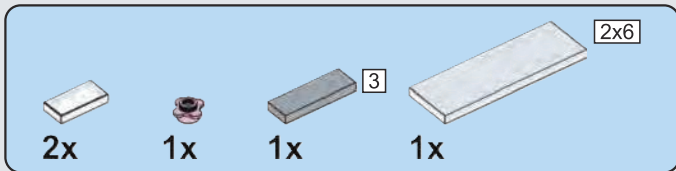

# C10

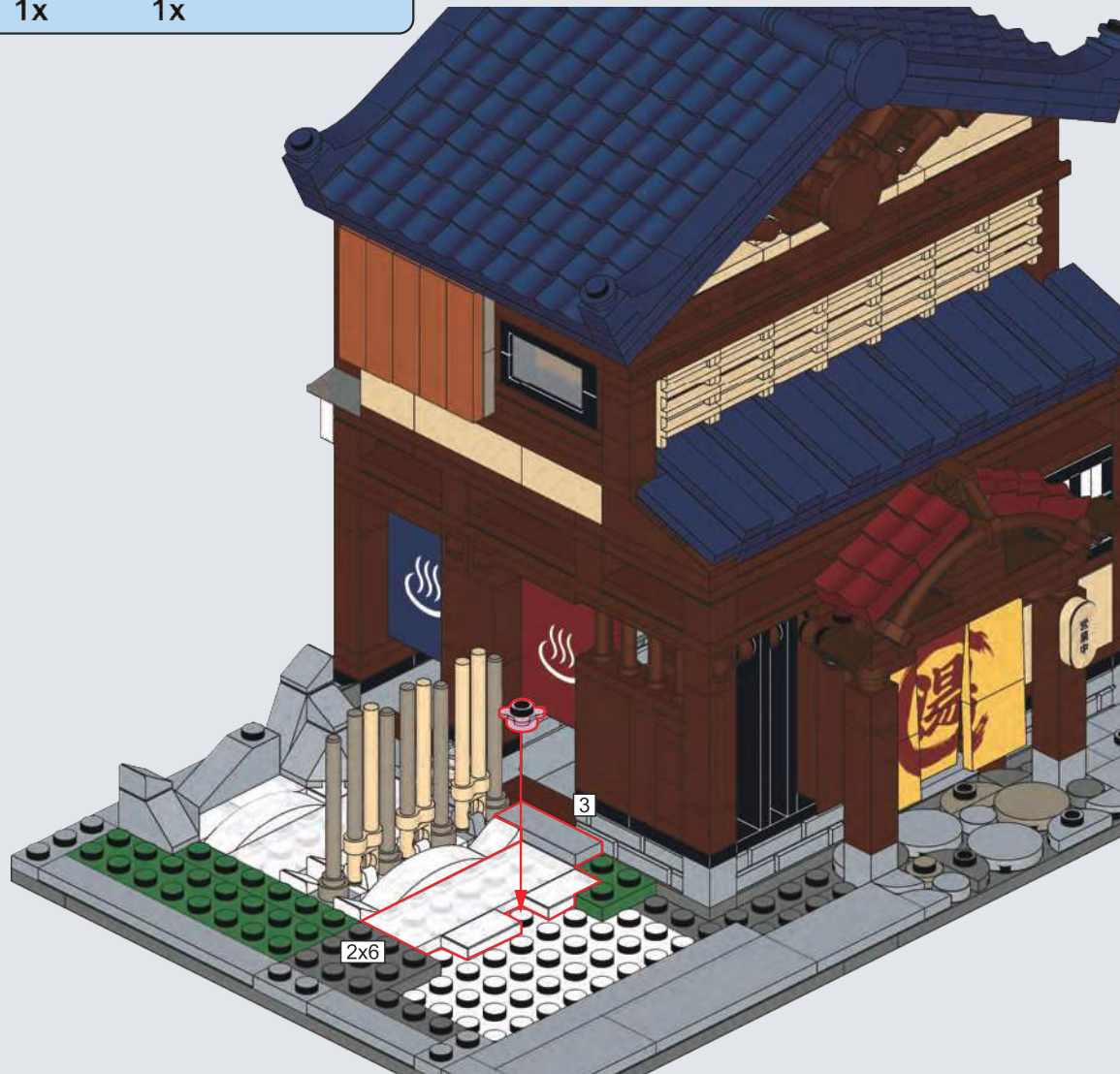

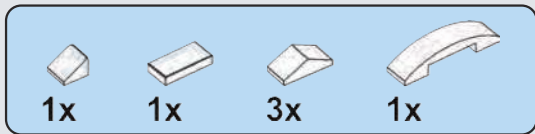

**C11**



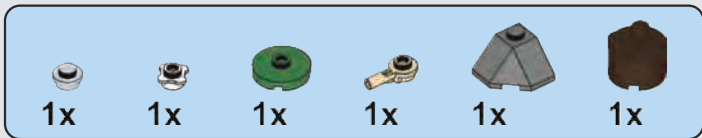

**C12**



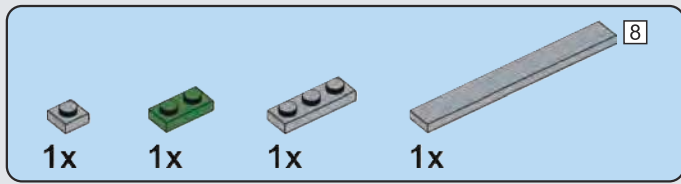

# C13



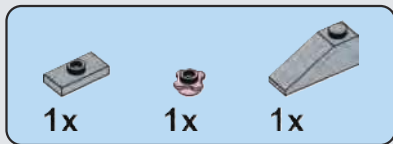

**C14**



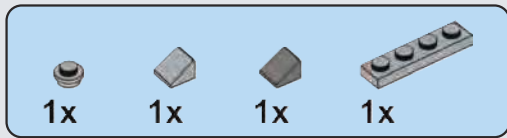

**C15**



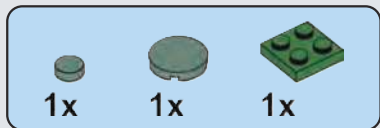

**C16**



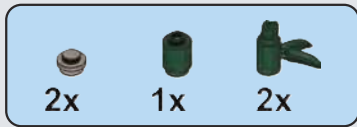

# C17

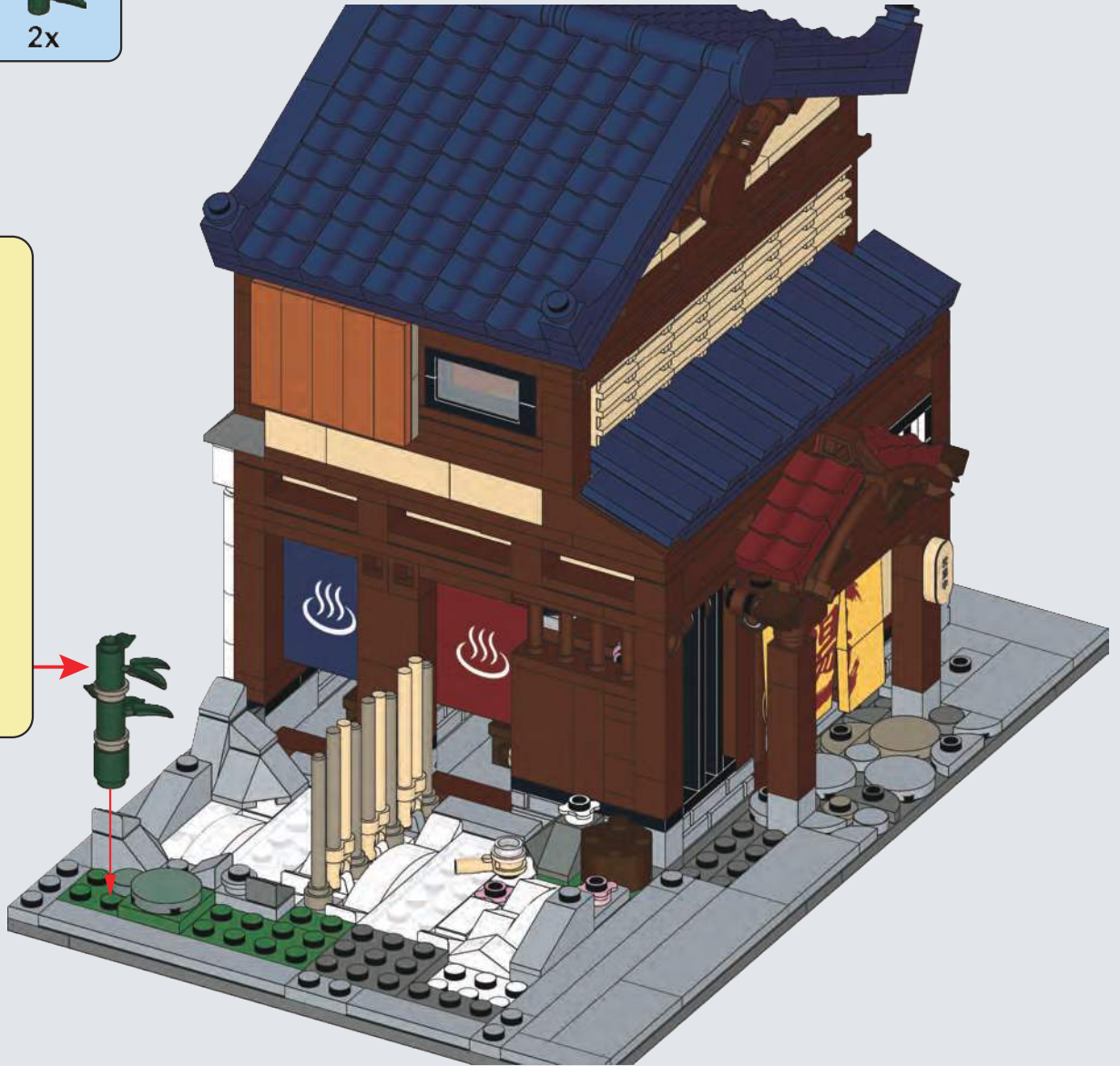
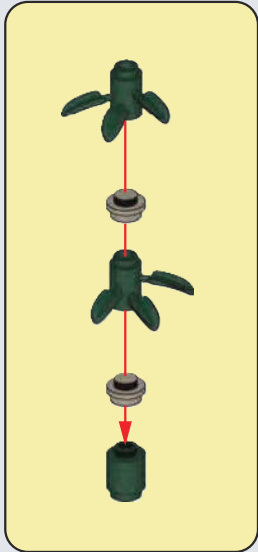



C21

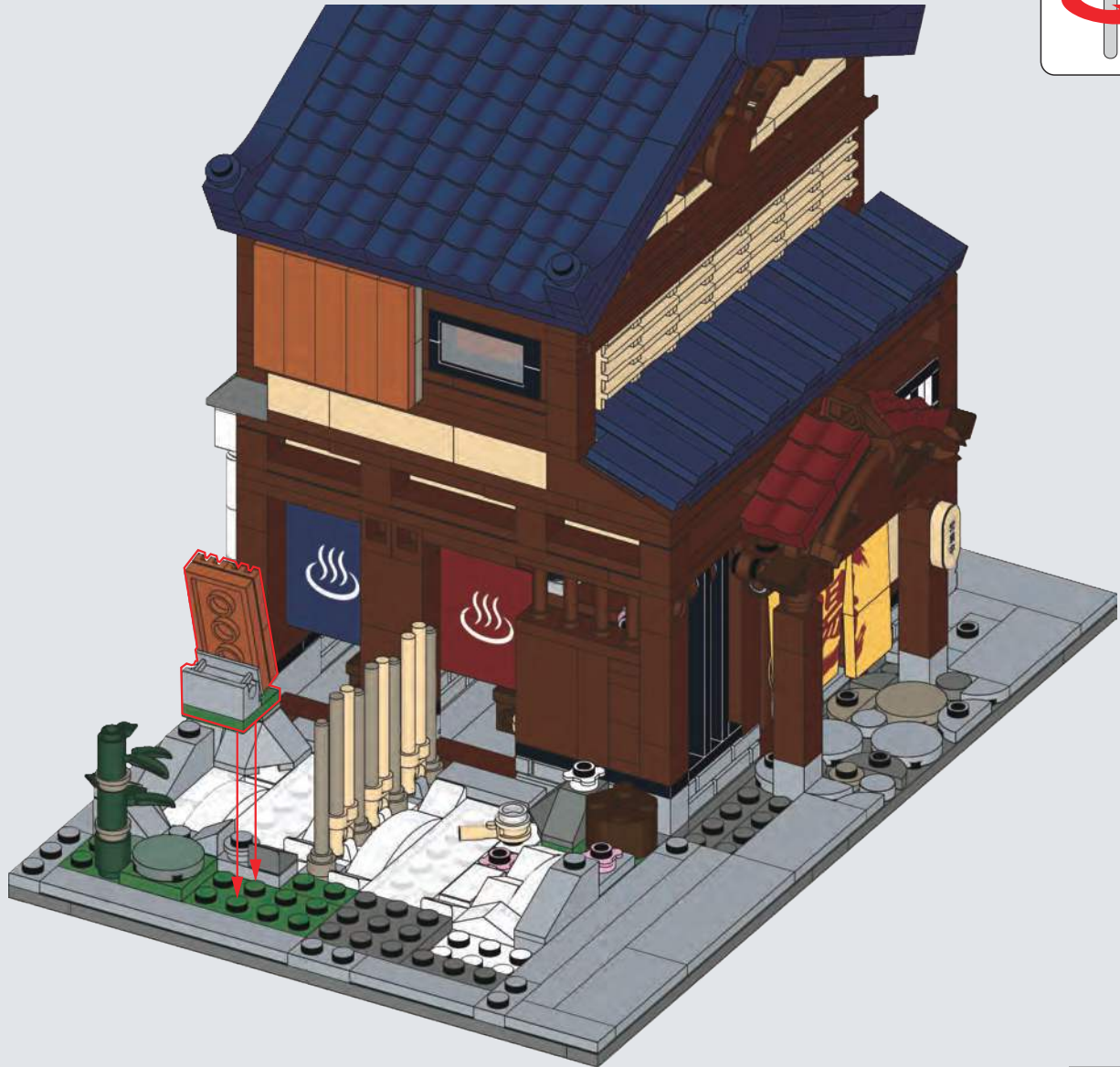

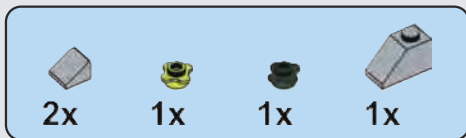

**C22**

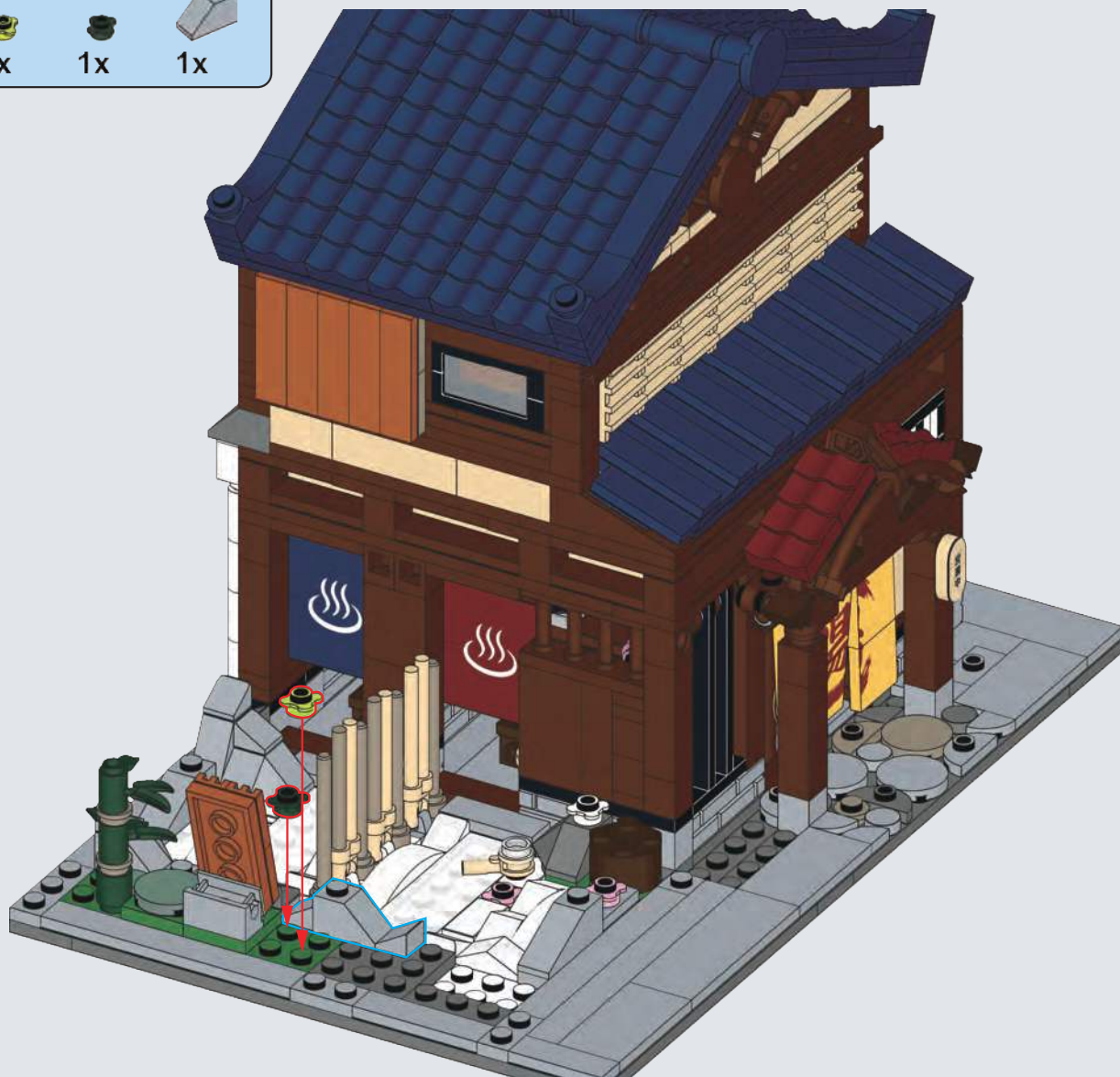

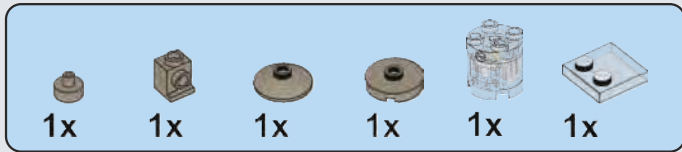

# C23

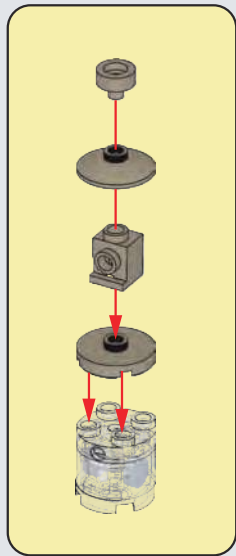



**C24**

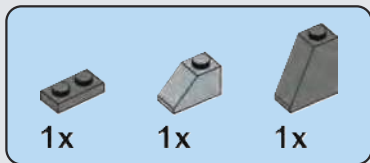

**C25**

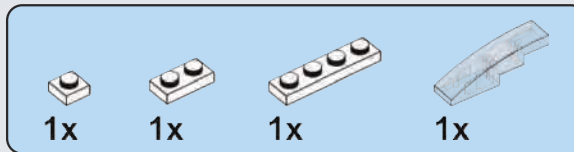
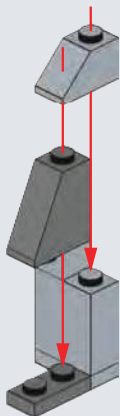

**C26**

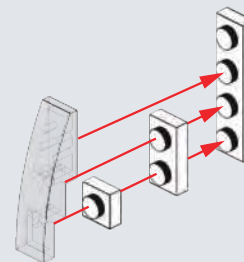

**C27**

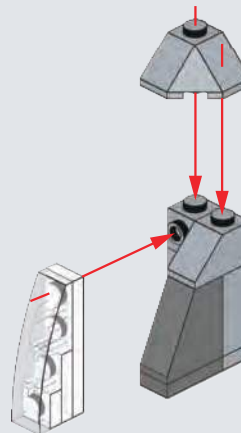

C28

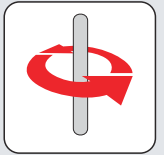

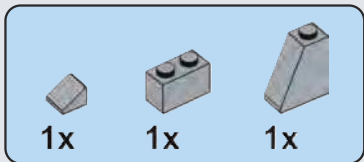

**C29**

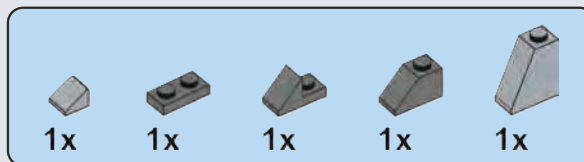
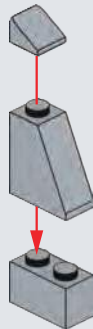

**C30**

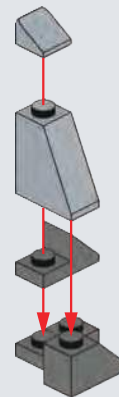

# C31

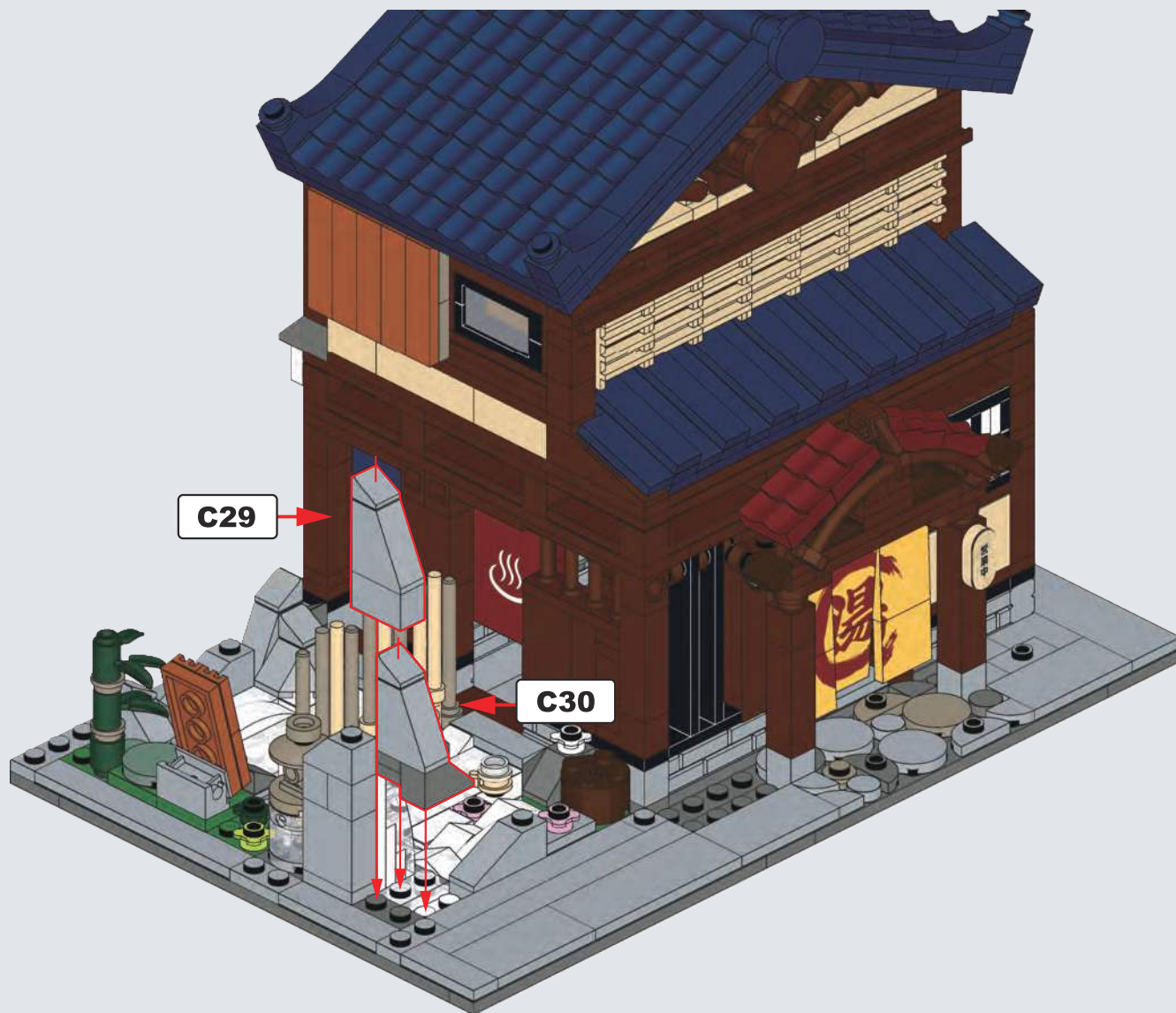

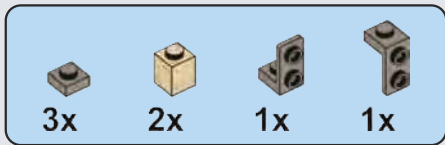

## C32

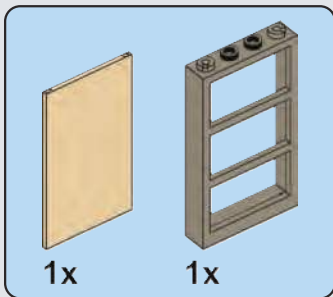

## C33

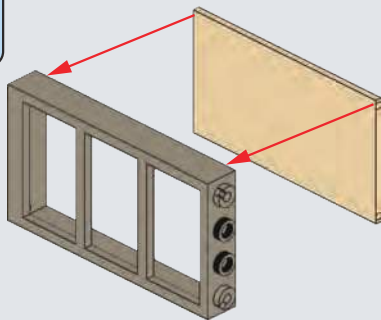

## C34

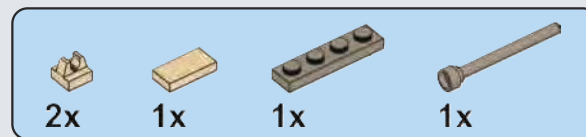
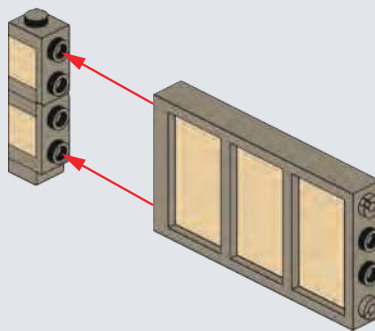

## C35

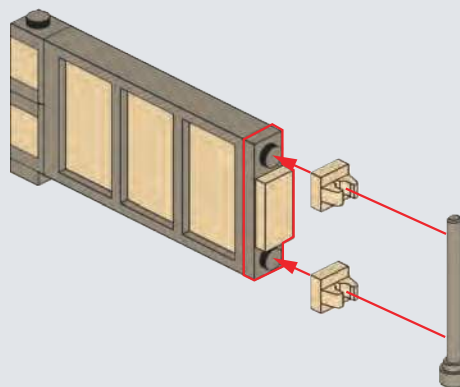

C36

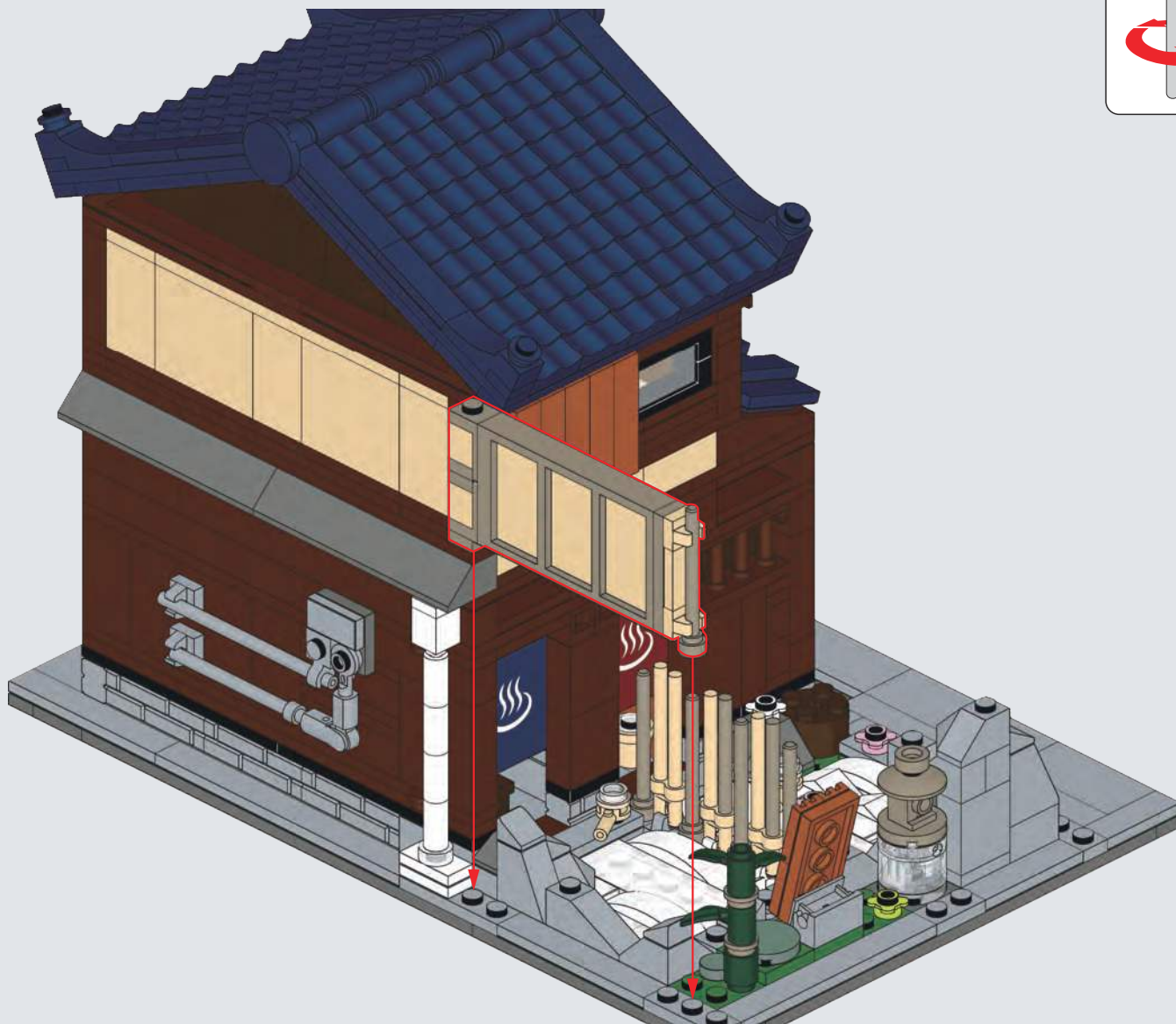
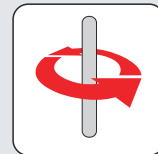

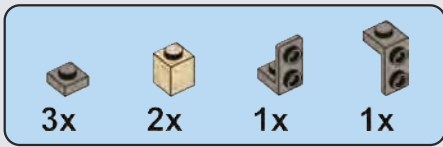

### C37

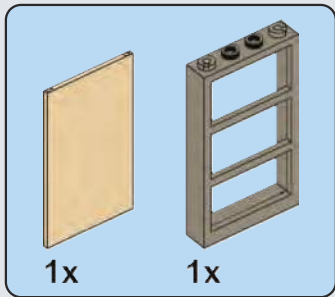

### C38

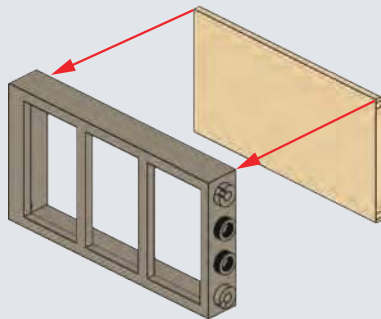

### C39

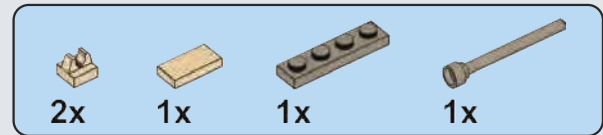
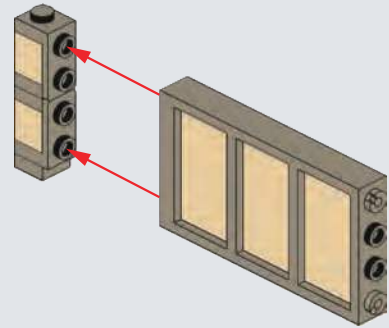

### C40

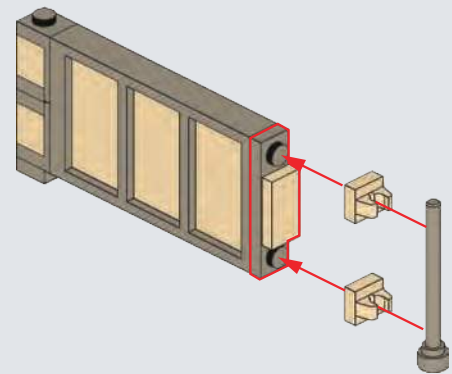

C41

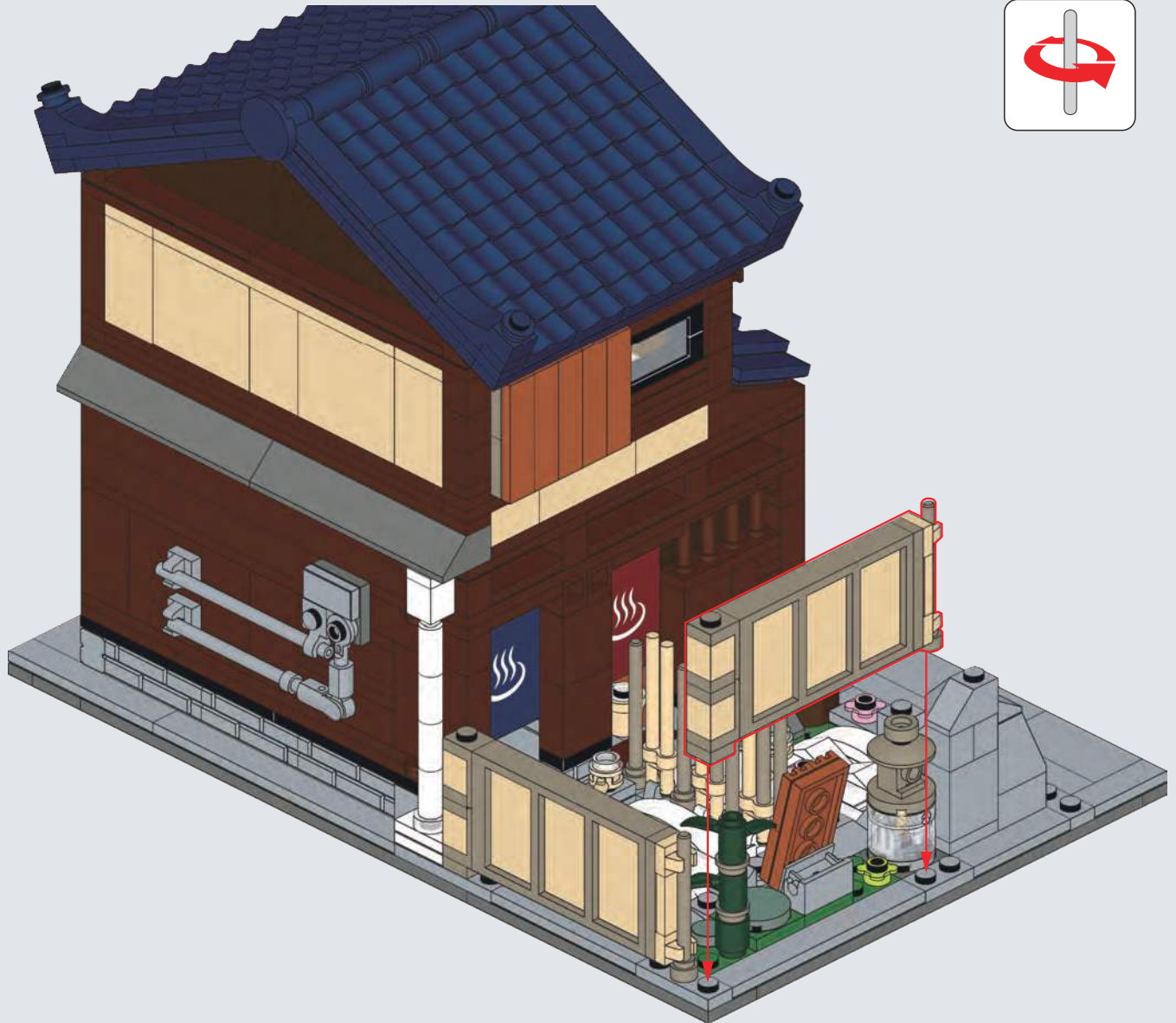

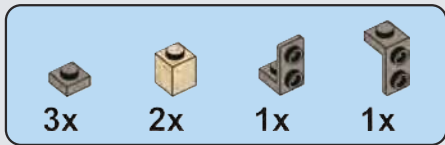

## C42

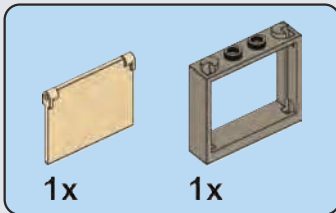
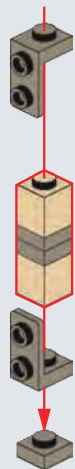

## C43

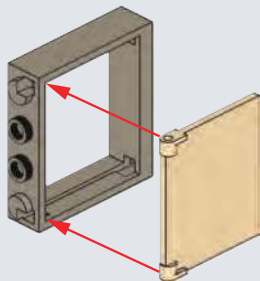

## C44

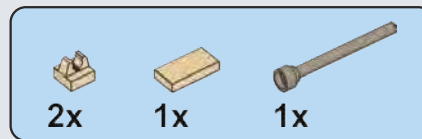
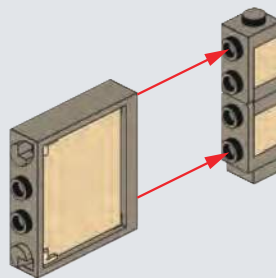

## C45

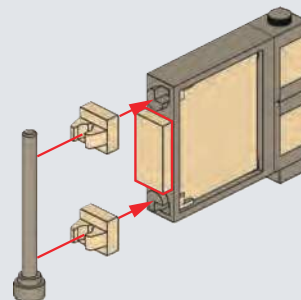



C46

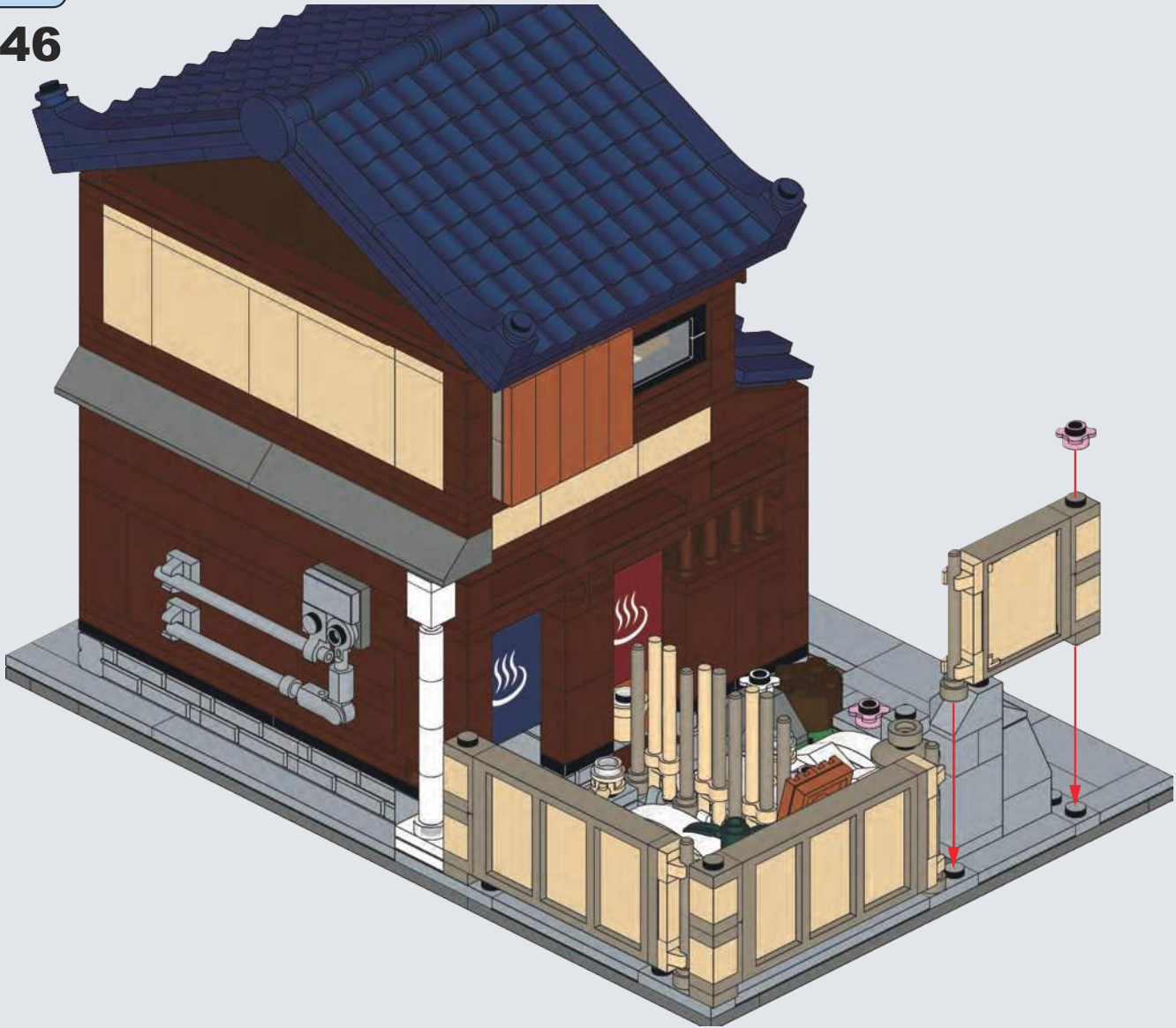

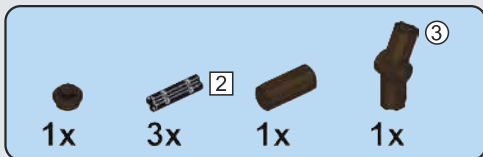

## C47

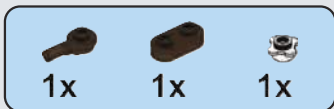
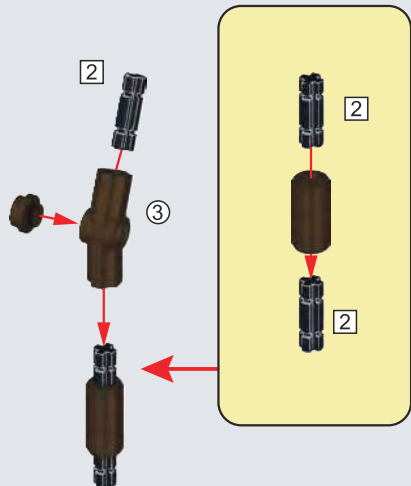

## C48

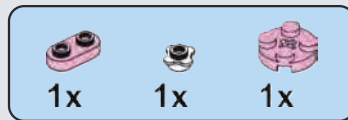

## C49

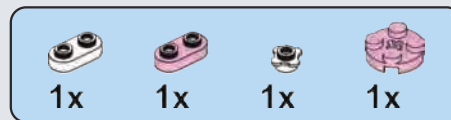
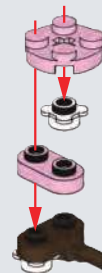

## C50

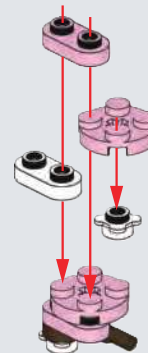

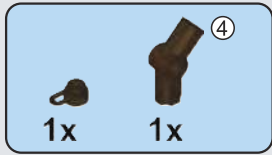

### C51

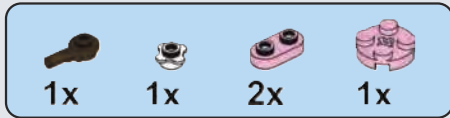
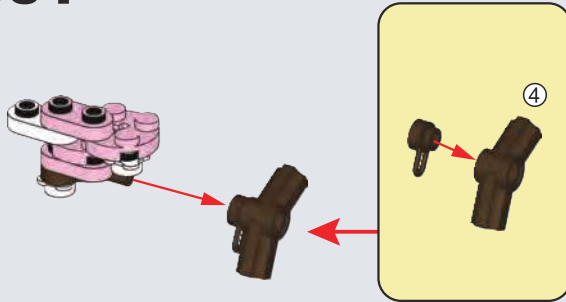

### C52

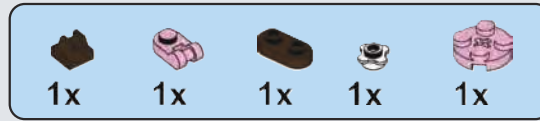
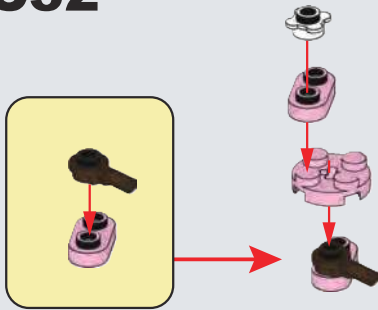

### C53

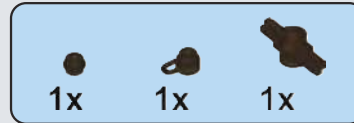
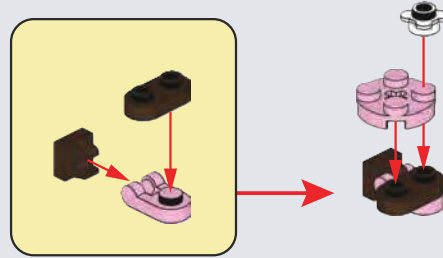

### C54

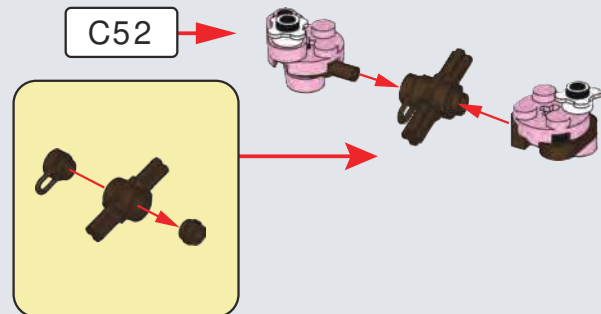

# C55

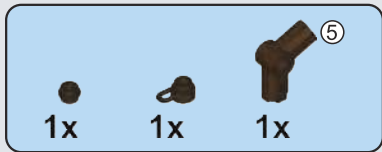
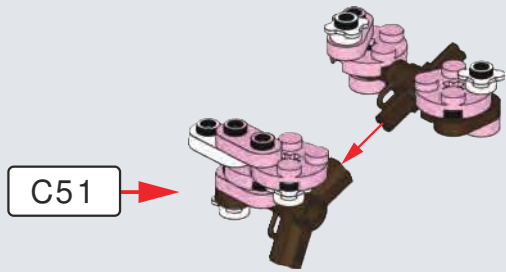

# C56



# C57

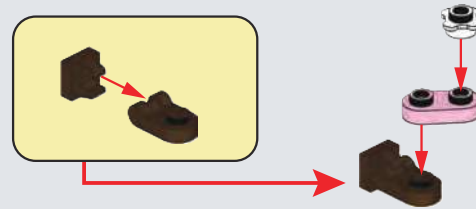

# C58



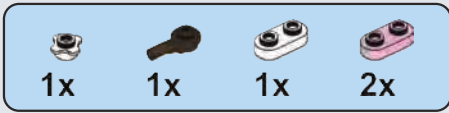

### C59



### C60



### C61

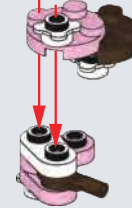

### C62

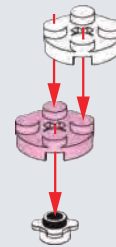



### C63

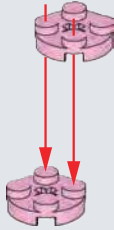

### C64

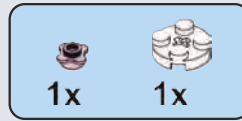
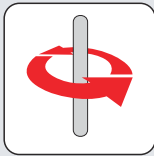
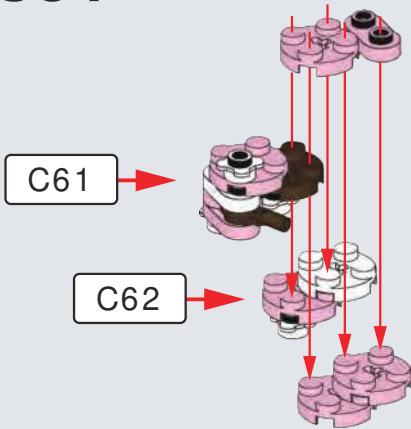

### C65

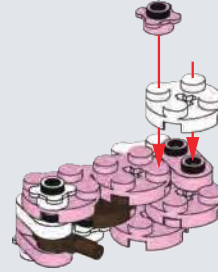

### C66



# C67

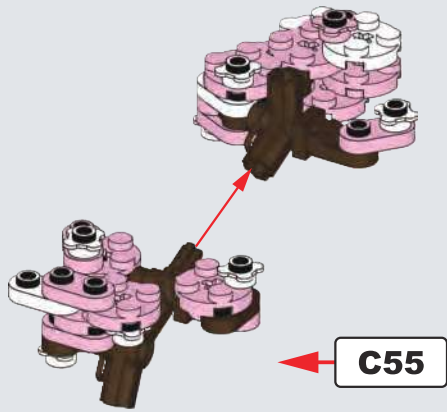

# C68

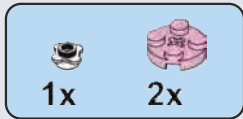
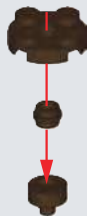

# C69

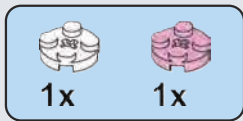
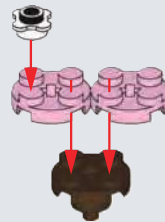

# C70

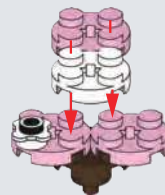



## C71

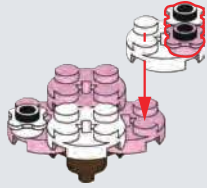

## C72

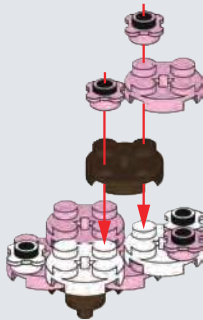

## C73

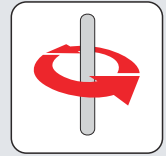
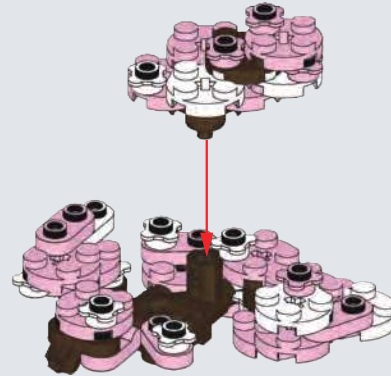

## C74

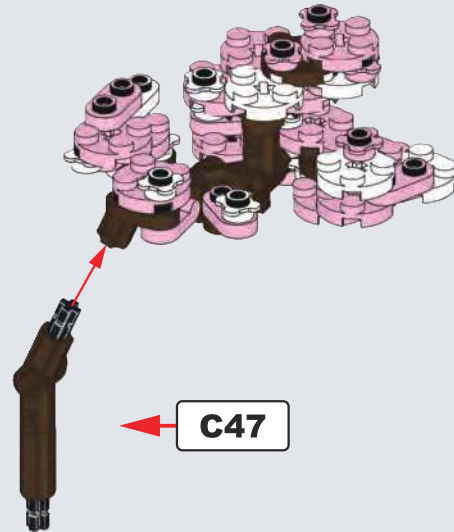

C75



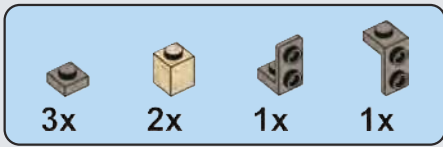

## C76

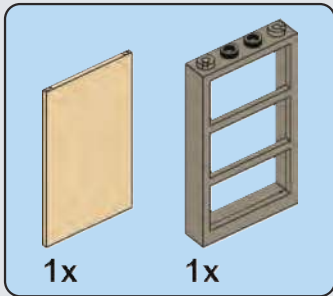
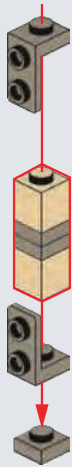

## C77

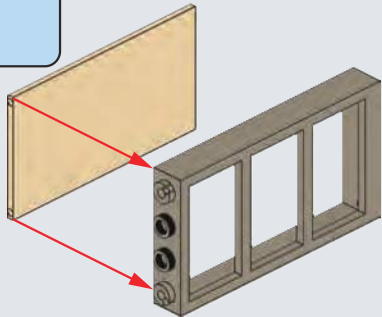

## C78

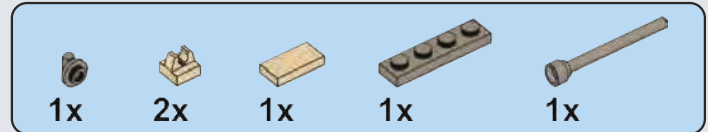
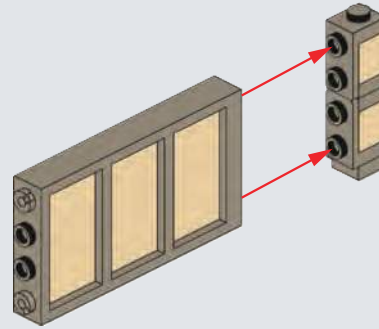

## C79

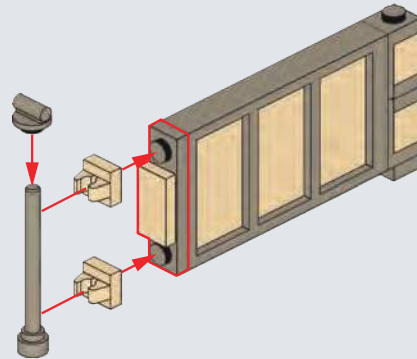

C80



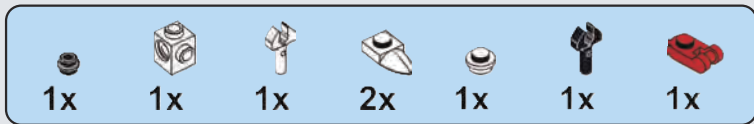

# C81

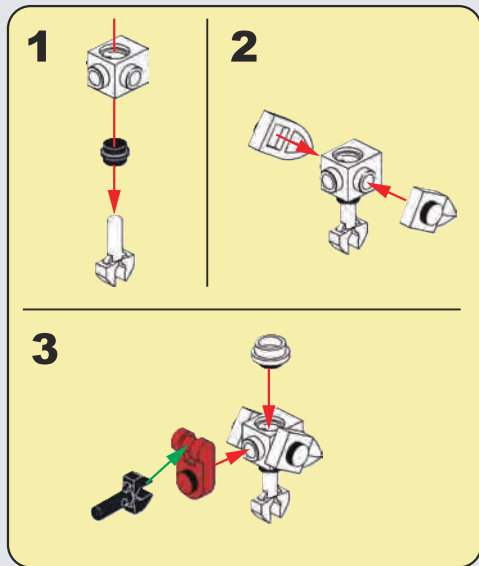

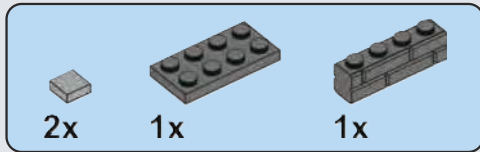

## C82

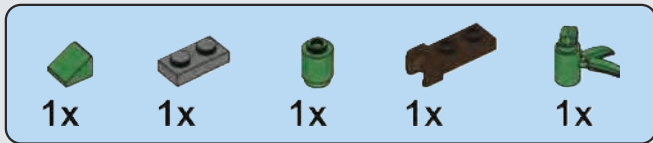
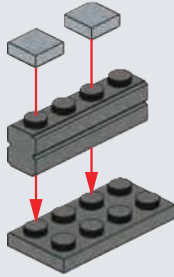

## C83

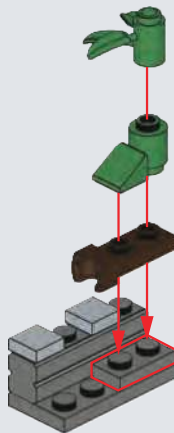

## C84

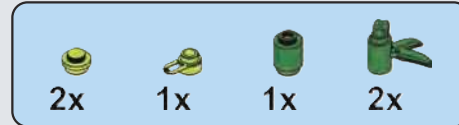
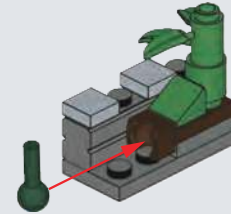

## C85

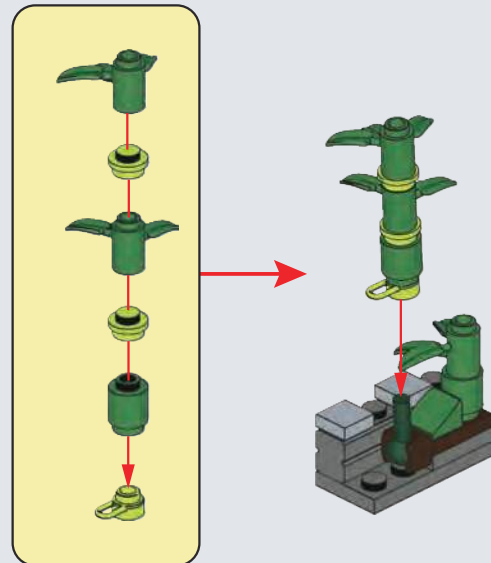



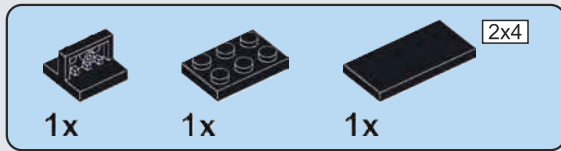

# C87

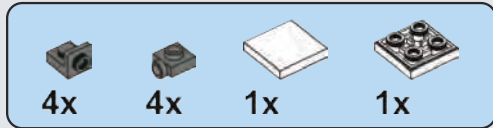
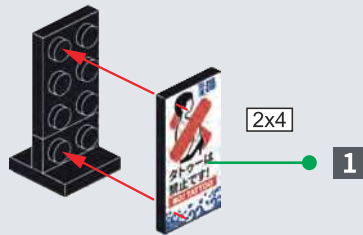

# C88

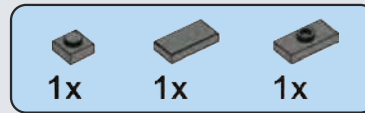
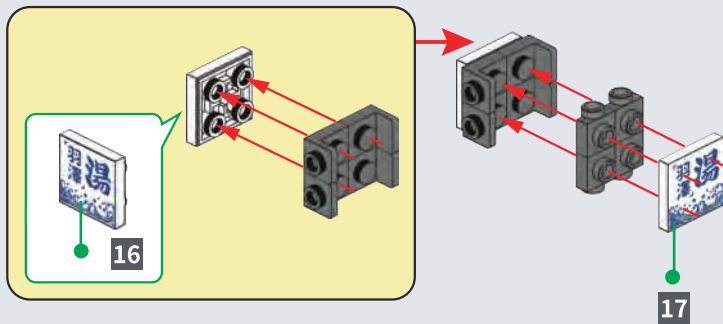

# C89

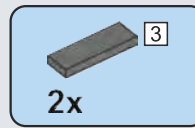
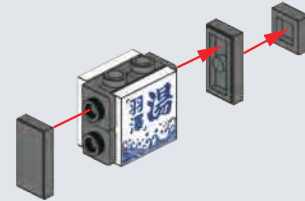

# C90

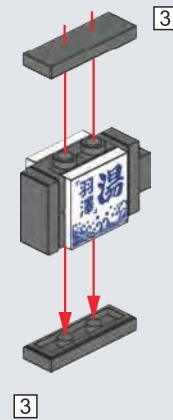



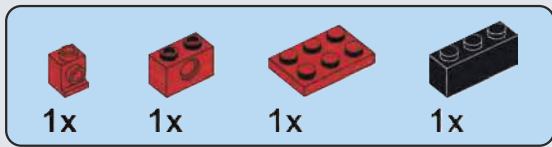

## C92

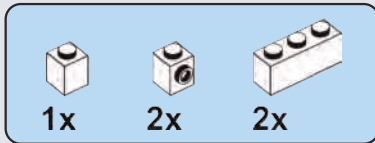
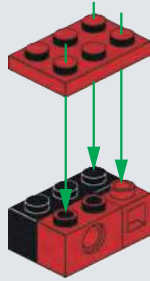

## C93

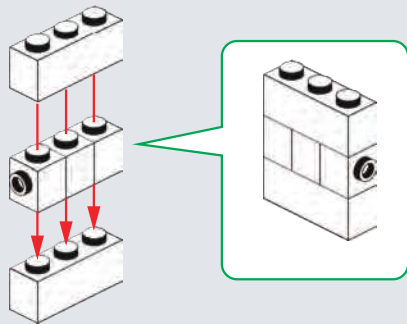

## C94

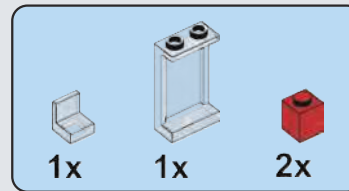
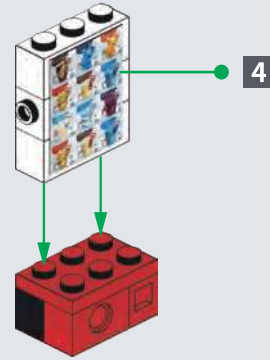

## C95

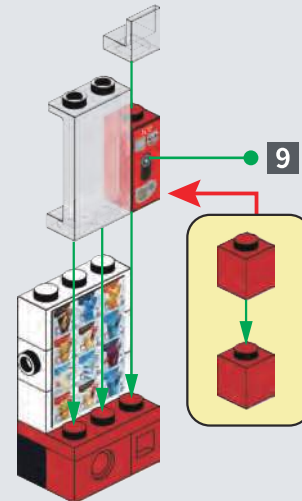

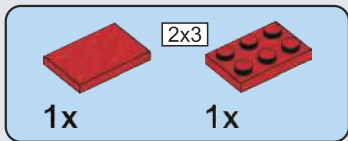

**C96**

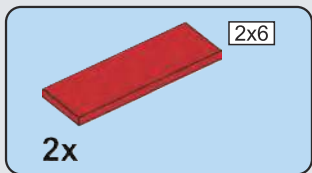

**C97**

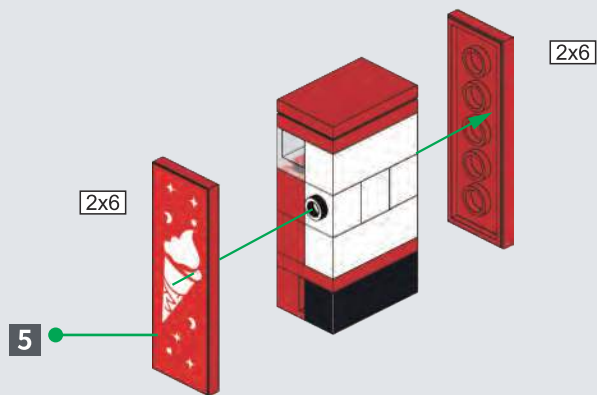

**C98**



C99

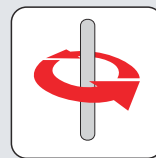

C91

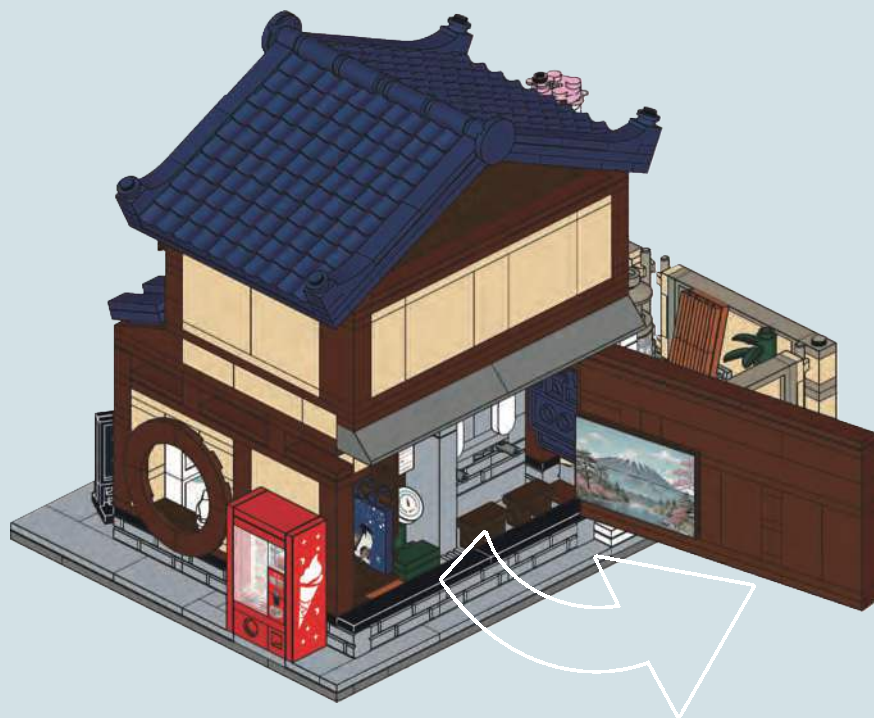

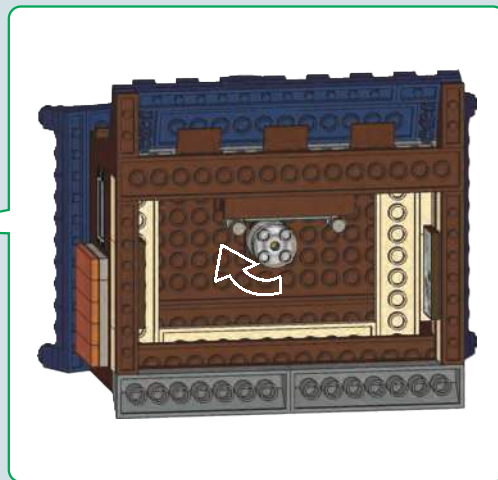



1x  
JF91310001  
 1x  
JB10160003  
 2x  
JA30280016  
 2x  
JF01260004  
 7x  
JA10150009  
 1x  
JA20170001  
 1x  
JX80750001  
 3x  
JH00110001  
 1x  
JA30290001  
 3x  
JA10140001  
 2x  
JA40360001  
 1x  
JF00690001  
 1x  
JD20180001

2x  
JX32440005  
 1x  
JA10130002  
 1x  
JA30300002  
 1x  
JA20190007  
 2x  
JA10070001  
 2x  
JA10120001  
 2x  
JA30310002  
 1x  
JA10060002  
 1x  
JA30410008  
 3x  
JA30320005

3

4

2x4

6

1x  
JA30330004  
 1x  
JA10660001  
 3x  
JB10160005  
 2x  
JA30580008  
 1x  
JA10150004  
 4x  
JF01260014  
 2x  
JD10010010  
 3x  
JX81340003  
 4x  
JF00820008  
 1x  
JE00620004  
 5x  
JA10140010  
 1x  
JA40360003  
 1x  
JA30290014  
 1x  
JD20360007

8

1x  
JD20030011  
 2x  
JE30150010  
 1x  
JA10080014  
 4x  
JF10130005  
 1x  
JD20340012  
 1x  
JD20380006  
 2x  
JA30300016  
 1x  
JA10130015  
 2x  
JA10160008  
 2x  
JA20250010  
 3x  
JA10060013

3

4x  
JA10120003  
 1x  
JX31140001  
 2x  
JA10540004  
 2x  
JT45400002  
 1x  
JA10030003  
 7x  
JA10660002  
 3x  
JA10840002  
 1x  
JA10750003

2x  
JB10160001

1x  
JB10010004

1x  
JF10700009

3x  
JA30580006

3x  
JA10150014

3x  
JA30280011

8x  
JD10010008

1x  
JF20260003

3x  
JF20110010

1x  
JX80950005

1x  
JX80970004

7x  
JH20150001

4x  
JF00920005

1x  
JX81340002

9x  
JA20170007

2x  
JE00620005

3x  
JA10140003

4x  
JA40360006

3x  
JA30290009

1x  
JX80010004

1x  
JF10930017

4x  
JX31150003

1x  
JA20180002

1x  
JF20120002

1x  
JF20120002

2x  
JD20030007

1x  
JX31050005

2x  
JB10040004

2x  
JA30780003

2x  
JA40770006

1x  
JA30340003

3x  
JD20380001

3x  
JD20340005

1x  
JA20790006

3x  
JA10130011

3x  
JA30300007

2x  
JD20050008

1x  
JA20710007

1x  
JA20190010

1x  
JA10070003

1x  
JA30350009

3x  
JA30310001

6x  
JA10120013

11x  
JX31140003

5x  
JA30410007

1x  
JF11050005

1x  
JT10020099

2x3

4

2x4

7

6

3x  
JA30320003

1x  
JA10110002

1x  
JA20210006

2x6

4x  
JA30930007

8

2x  
JA30330002

2x  
JA30380004

2x  
JF91310005

1x  
JB10010003

2x  
JB10160002

13x  
JX52180014

1x  
JX51450005

3x  
JA30280010

15x  
JA10150006

2x  
JF20110002

1x  
JF01260003

3x  
JB30030006

1x  
JX80750010

4x  
JX91060004

1x  
JT45650004

2x  
JX81040002

1x  
JF01300005

3x  
JF00920008

1x  
JA20170002

1x  
JB10230004

3x  
JG20230017

2x  
JE90220018

1x  
JA30290002

3x  
JA10140002

2x  
JA40360002

2x  
JA20180007

2x  
JA30340010

1x  
JB10040014

4x  
JB10120007

1x  
JA30690010

2x3

1x  
JA30350004

2x  
JA20190008

1x  
JA10120002

2x  
JX32150006

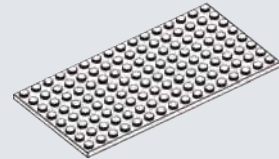

1x  
JA10760009

2x  
JF91310003

2x  
JB10010024

1x  
JX52180022

5x  
JF10700015

11x  
JF01260019

17x  
JA10150013

3x  
JA30280014

6x  
JD10010014

1x  
JF20260011

4x  
JF20110013

2x  
JX80750011

2x  
JX80950010

3x  
JX80970021

15x  
JA20170009

1x  
JJ00010012

7x  
JF00920012

2x  
JF00650017

1x  
JF11210018

6x  
JA20920006

3x  
JA20860004

5x  
JF00330008

2x  
JE90220025

2x  
JX81340014

8x  
JA10140018

7x  
JA30290015

1x  
JA40360014

2x  
JF80720018

1x  
JF11240003

9x  
JF20120015

1x  
JG20010013

2x  
JF60740010

2x  
JF60750010

2x  
JA20180011

1x  
JJ00020012

1x  
JB10040015

5x  
JA40770010

1x  
JA10080013

1x  
JA30340015

7x  
JF10130009

2x  
JA20790005

7x  
JA20960010

4x  
JA31010004

7x  
JA30300012

8x  
JA10130014

2x3

3x  
JA30350012

7x  
JA10120014

4

5x  
JA30310012

2x  
JD20330014

4x  
JF00780003

3x  
JA40610013

2x  
JB20390006

1x  
JX91310001

1x  
JA10060015

2x4

2x  
JA30410011

4x  
JA20200011

4x  
JF10460013

5x  
JA30320009

3x  
JA10110011

3x  
JA10050013

1x  
JA20210015

1x  
JT10030052



2x6

2x  
JA30930014



8

3x  
JA30330010



8x  
JA10100010



2x  
JF91030012



3x  
JA10090013



3x  
JA20800005



5x  
JA10660007



3x  
JA10400007



4x  
JA10840003



1x  
JA11000001



4x  
JF91310008



3x  
JX31200003



4x  
JB10010020



1x  
JX52180021



1x  
JF10700020



1x  
JA30280029



14x  
JF01260001



2x  
JF20110015



3x  
JA10150026



4x  
JD10010023



3x  
JF00820018



1x  
JJ00010018



16x  
JA30600013



11x  
JF00920030



8x  
JA20170030



1x  
JF10660024



5



1x  
JH60290017



3



1x  
JH60310023



4



1x  
JH60300019



4x  
JD10130009



3x  
JX81340012



2x  
JE90220024



7x  
JA10140027



1x  
JA40360029



7x  
JA30290027



2x  
JF10930012



3x  
JF00990026



1x  
JH10190020



3x  
JB10120039



1x  
JA20180032



2x  
JA30570017



1x  
JH60850016



1x  
JA30780020



6x  
JD20340017



1x  
JA20790015



2x  
JA30340033



1x  
JA40770022



1x  
JF00140020



2x  
JF10130014

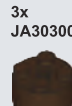

1x  
JF40970009



3x  
JA30300029

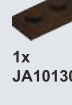

1x  
JA10130031



4x  
JD20050009



2x  
JD20330013



2x  
JA30310024



2x  
JA10160017



3x  
JA10120027



3x  
JA30410026



2x  
JF80870010



2x  
JA10110020

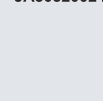

2x  
JA30320024



1x  
JA20210019



1x  
JA10050029



2x6

4x  
JA30930015



1x  
JA10540012



1x  
JA20800007



2x  
JA10150031



4x  
JX80010025



1x  
JA30290032



1x  
JA30340025



1x  
JA40770026



3



4x  
JA30300027

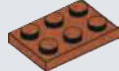

1x  
JA10070023



4

6x  
JA30310029

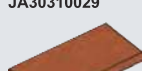

2x4

4x  
JA30410033

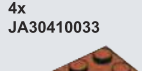

1x  
JA10060026



6

1x  
JA30320023

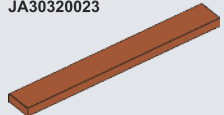

8

2x  
JA30330025



10

2x  
JA30380020



7x  
JX52180008



1x  
JF10660023



1x  
JA10140015



1x  
JA30290024



8x  
JE90220027



13x  
JB10120021



1x  
JB30310009



1x  
JX81340008



1x  
JF10660005



1x  
JF00650008



2x  
JA20170004



1x  
JJ00020006



1x  
JA30350006



2x  
JA10070006



2x  
JA10070006



2x  
JA10070006

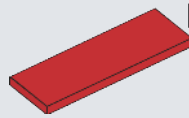

2x6

2x  
JA30930019



2x  
JF20260012



4x  
JX31110007

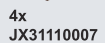

1x  
JA10070022



2x  
JA30350024



2x  
JA30350024

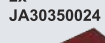

1x  
JF21250004



3x  
JB10010014



2x  
JB20020017



6x  
JB10010028



4x  
JA10150019



2x  
JF20260014



2x  
JX81340007



2x  
JB20020033



1x  
JA10140021



2x  
JB10040021



50x  
JX31110002



4x  
JH30210018



2x  
JF10130011



6x  
JA30300017



1x  
JA10130018



1x  
JA10130018



4x  
JT46570001



5x  
JA10070016



2x  
JA30350014



3x  
JA10400013



4

18x  
JA30310016



9x  
JA10120016



1x  
JF21250005



2x  
JA10060025

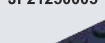

2x  
JA10050016



2x  
JA10090012



3x  
JA10660021



3x  
JA10400013

1x  
202RJT43790001

1x  
202RJT45720001

1x  
JB30030035

1x  
JX31200010

2x  
JB10010015

1x  
JX52180012

1x  
JD10010013

2x  
JB20020003

1x  
JB10200007

1x  
JE30150018

1x  
JA10140008

1x  
JA10080001

1x  
JA40770016

3x  
JX52860004

1x  
JA10100004

1x  
JA10040018

1x  
JX52180018

1x  
JF11170006

1x  
JF31070007

1x  
JB20020020

1x  
JX80950006

2x  
JX52860003

1x  
JA30290012

1x  
JF10060010

4x  
JF91310009

3x  
JB10010012

1x  
JF10700010

1x  
JF11160011

12x  
JA10150005

3x  
JB30030015

4x  
JF11210005

4x  
JF11220006

1x  
JF00650003

1x  
JE00620006

2x  
JA10140011

1x  
JB10200011

1x  
JB10040016

1x  
JB40240021

2x  
JF10460001

3x  
JA10120010

2x  
JA10060009

8x  
JF10250014

2x  
JE50310009

1x  
JX31250007

3x  
JT46310002

4x  
JA10150018

6x  
JF01260012

10x  
JF20110017

2x  
JB30030007

10x  
JA20170008

2x  
JF00920011

1x  
JK50120005

2x  
JX81340013

1x  
JG20230016

6x  
JA30290016

3x  
JT46190004

1x  
JF00990027

2x  
JA10140020

3x  
JA40360011

2x  
JF10060005

2x  
JA20180019

2x  
JD30070011

7x  
JX80070007

3x  
JA20960006

2x  
JA20190003

2x  
JA30310015



1x  
JA10120015



4x  
JF10460010

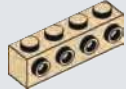

2x  
JF00780005



1x  
JA10060014



1x  
JX31400004



2x  
JX32110002



5x  
JX32120004



3x  
JX31390006

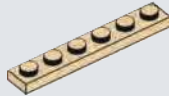

1x  
JA10110015

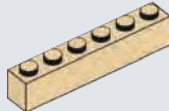

1x  
JA20210014

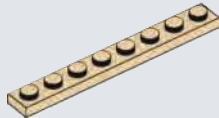

1x  
JA10100011

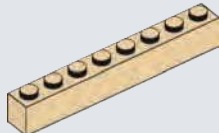

1x  
JA20220009

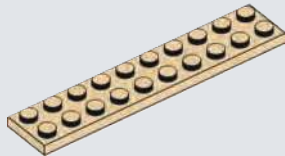

4x  
JA10030010

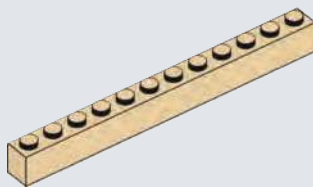

3x  
JA20810003



3x  
JB10010007



1x  
JF10700008



1x  
JA10150016



1x  
JA31040002



2x  
JT44760002



1x  
JA40770007



1x  
JC00020025



2x  
JT80140001



1x  
JX31380001



1x  
JX31530002



5x  
JD10010041



7x  
JA30290045



3x  
JD10130010



3x  
JA40770035



4x  
JC00270022



2x  
JA30930030



1x  
JB10160039



1x  
JB10040030

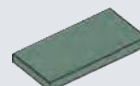

1x  
JA30410037



3x  
JB40150027



1x  
204RC660120001

2x6

2x4

CaDA<sup>®</sup>

 [www.doubleeagle-group.com](http://www.doubleeagle-group.com)

C66006



C66007



C66014



CaDA<sup>®</sup>

Sentō  
せんりん

C66012

