

OIL REFINERIES

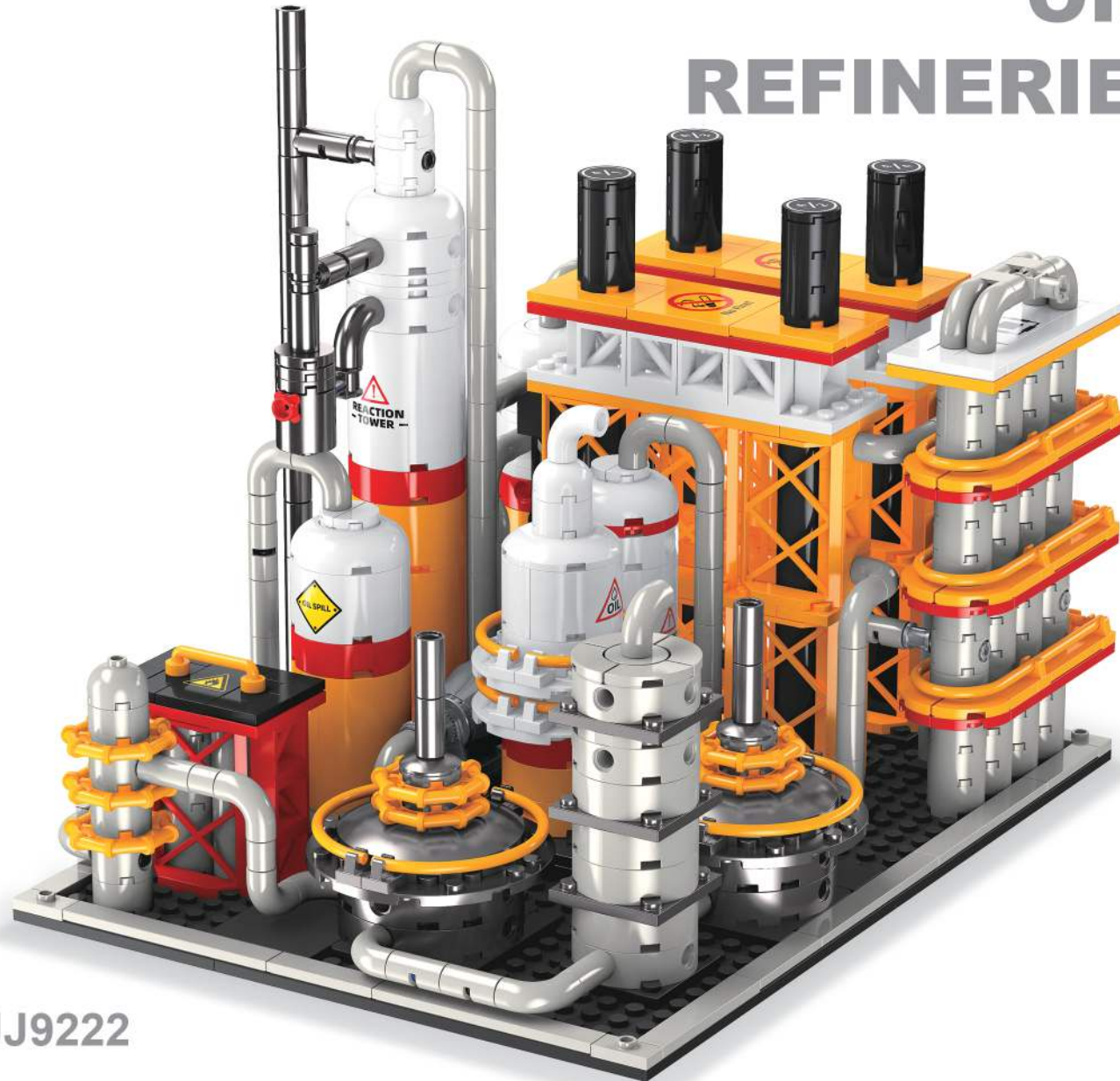

JJ9222



**PETROLEUM
ENGINEERING**

1:1 Label Length Comparison

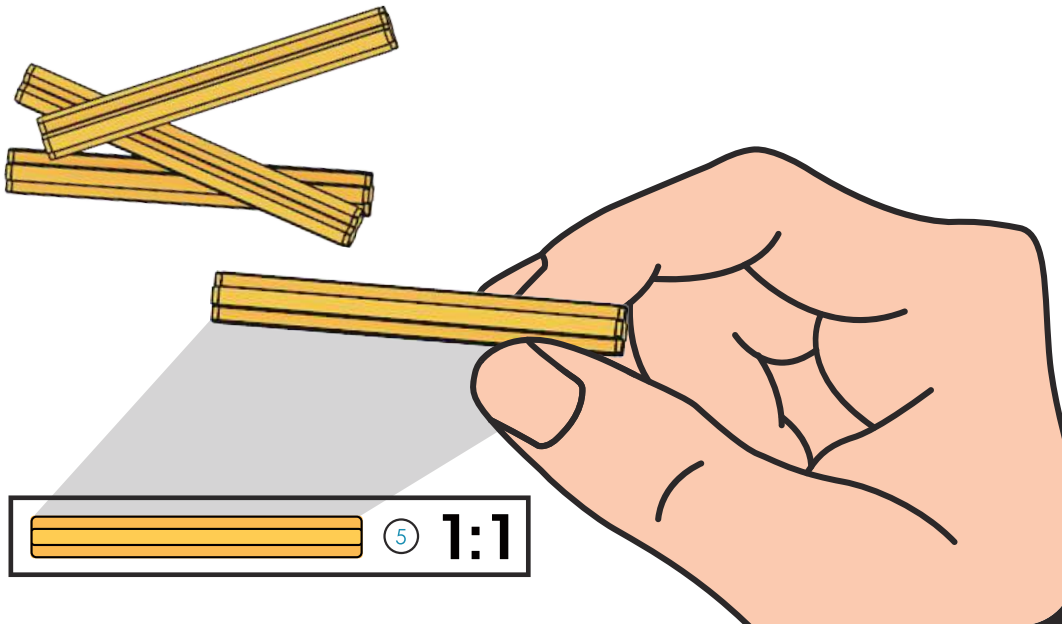

Turn over



Sticker



Luminous



Plating



Silver dot parts

Unpack according to the order of building block bags

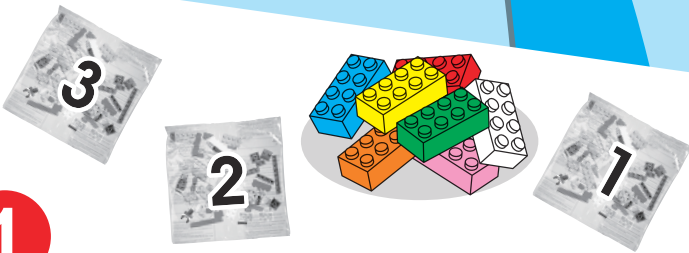

1

Sort by part color or shape

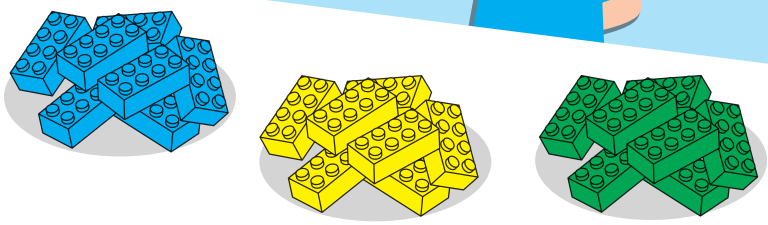

2

Sort the parts according to the instructions

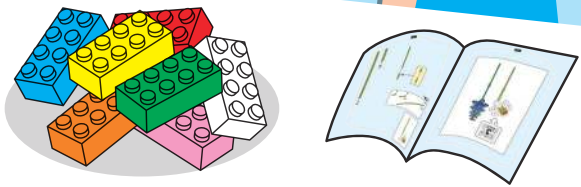

3

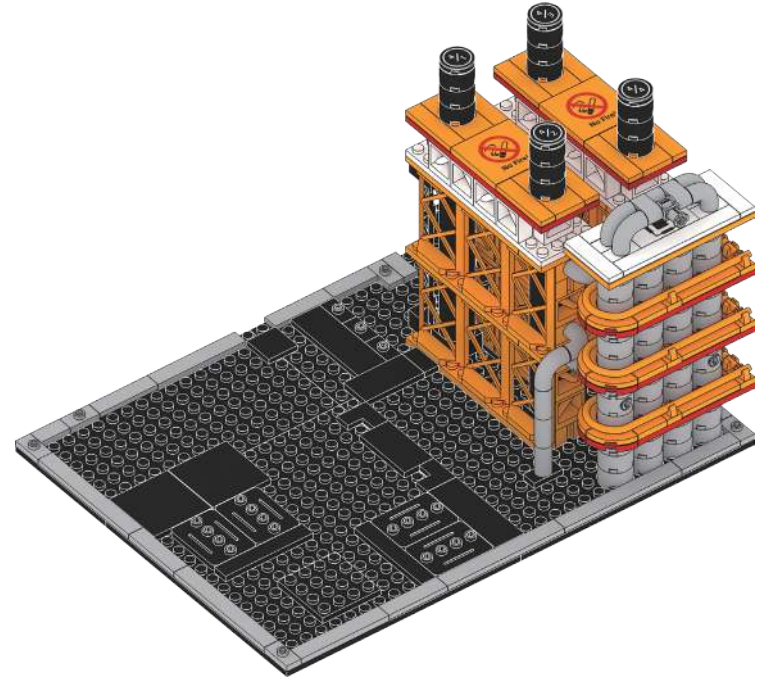
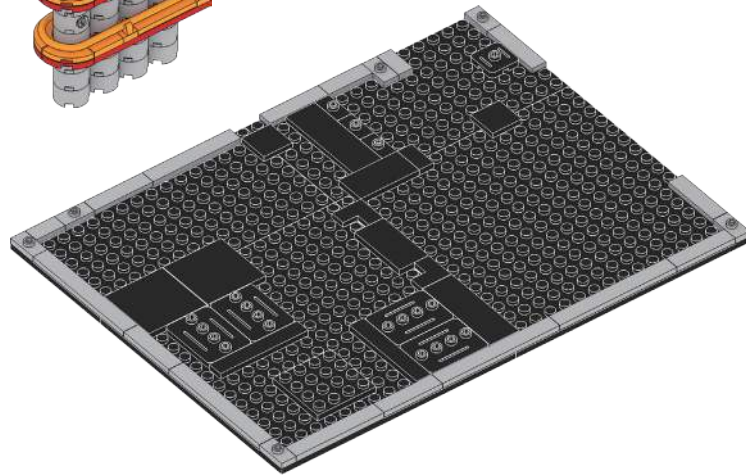
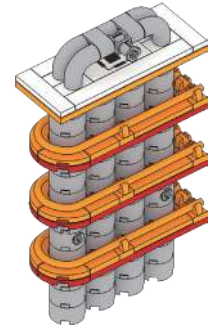

CONTENTS

Part 1.....

01

Part 2.....

17

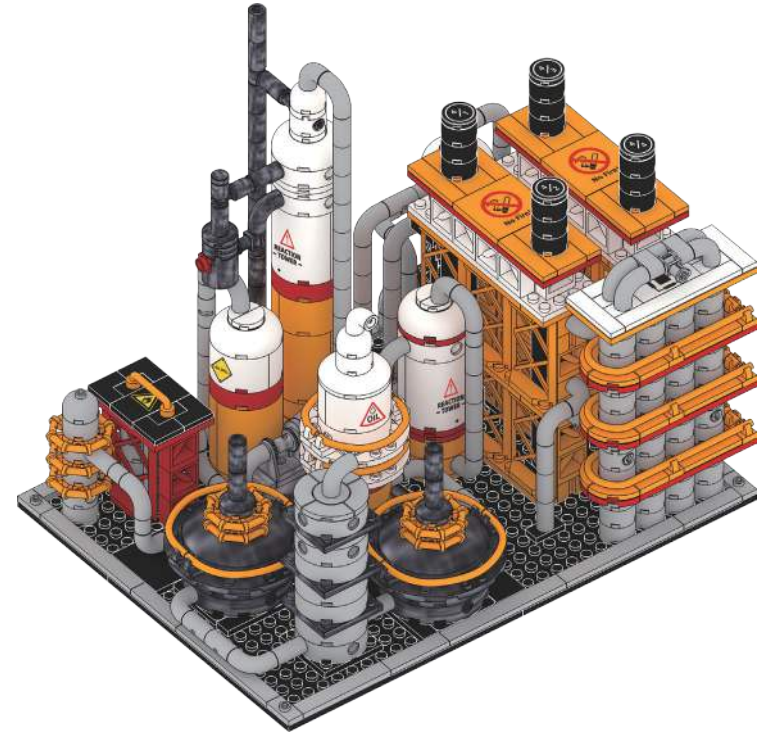
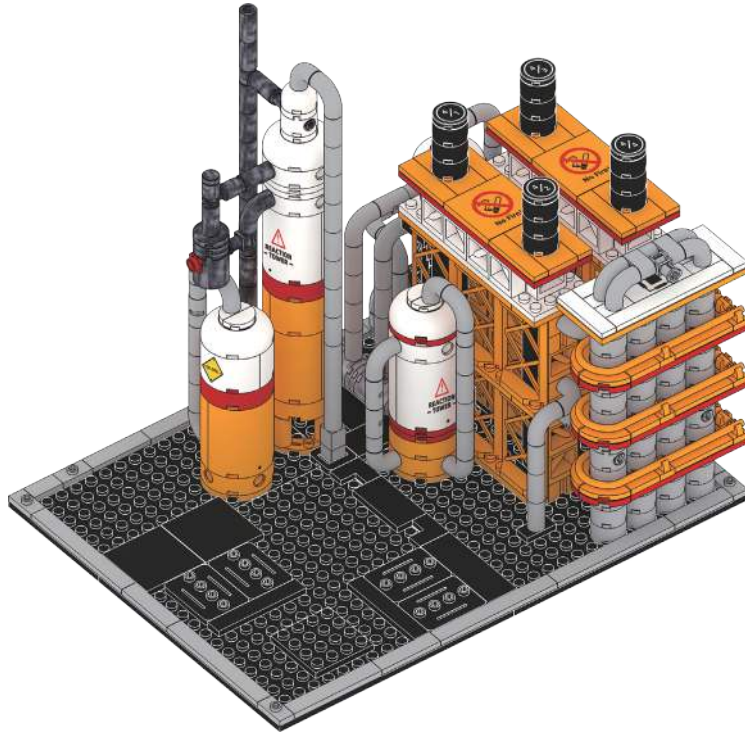

CONTENTS

Part 3.....

37

Part 4.....

65

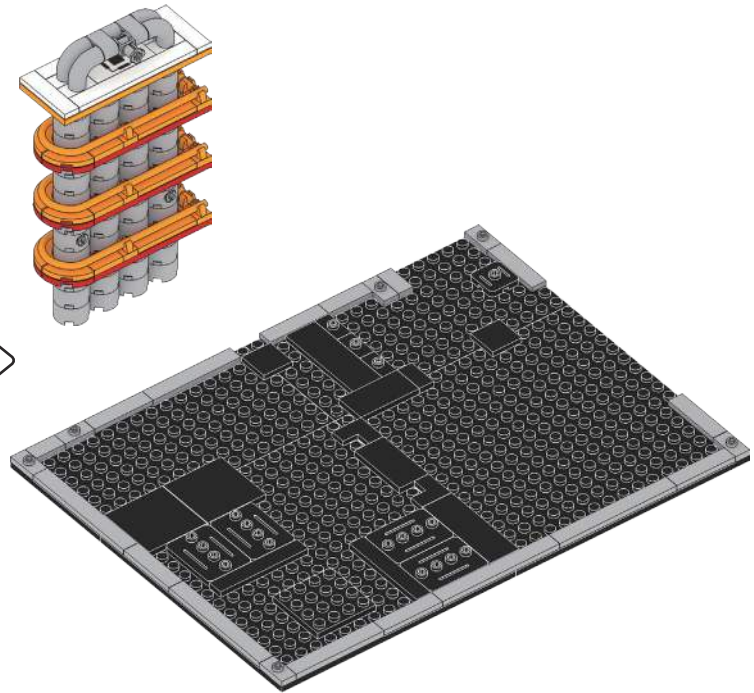
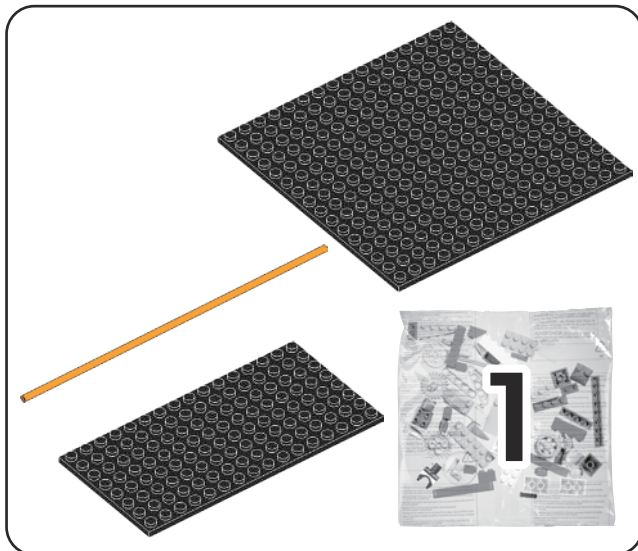

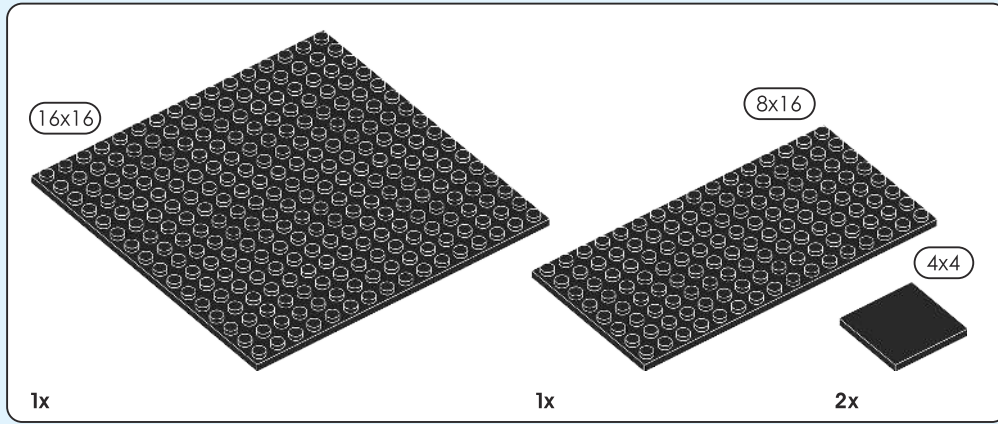

01

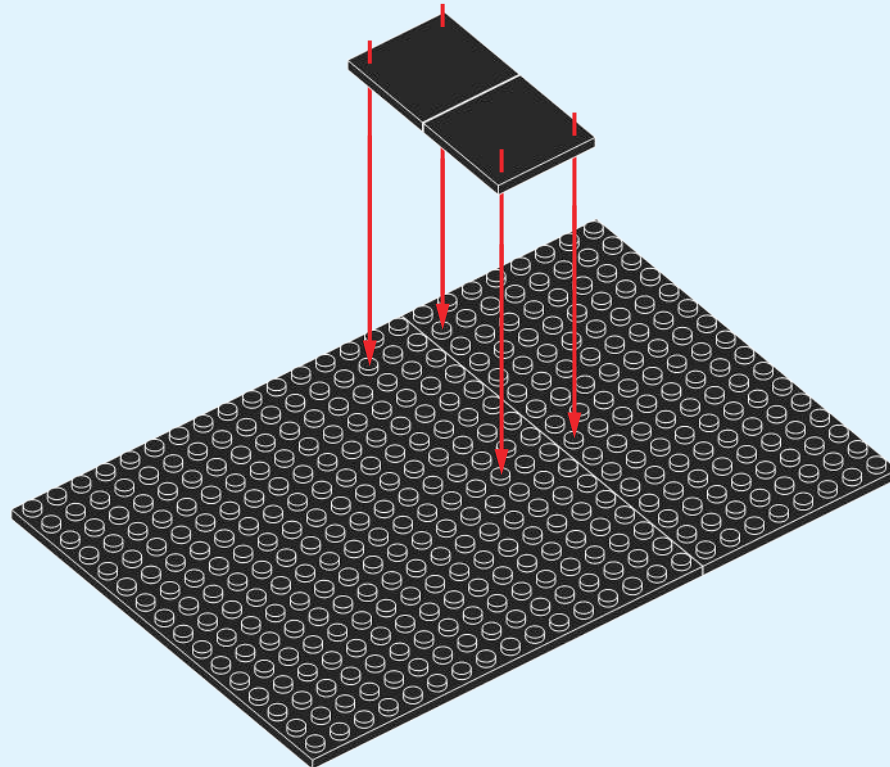

2

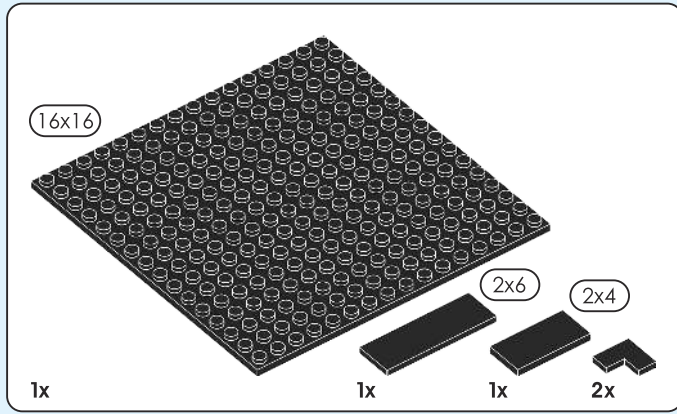

| 02 |

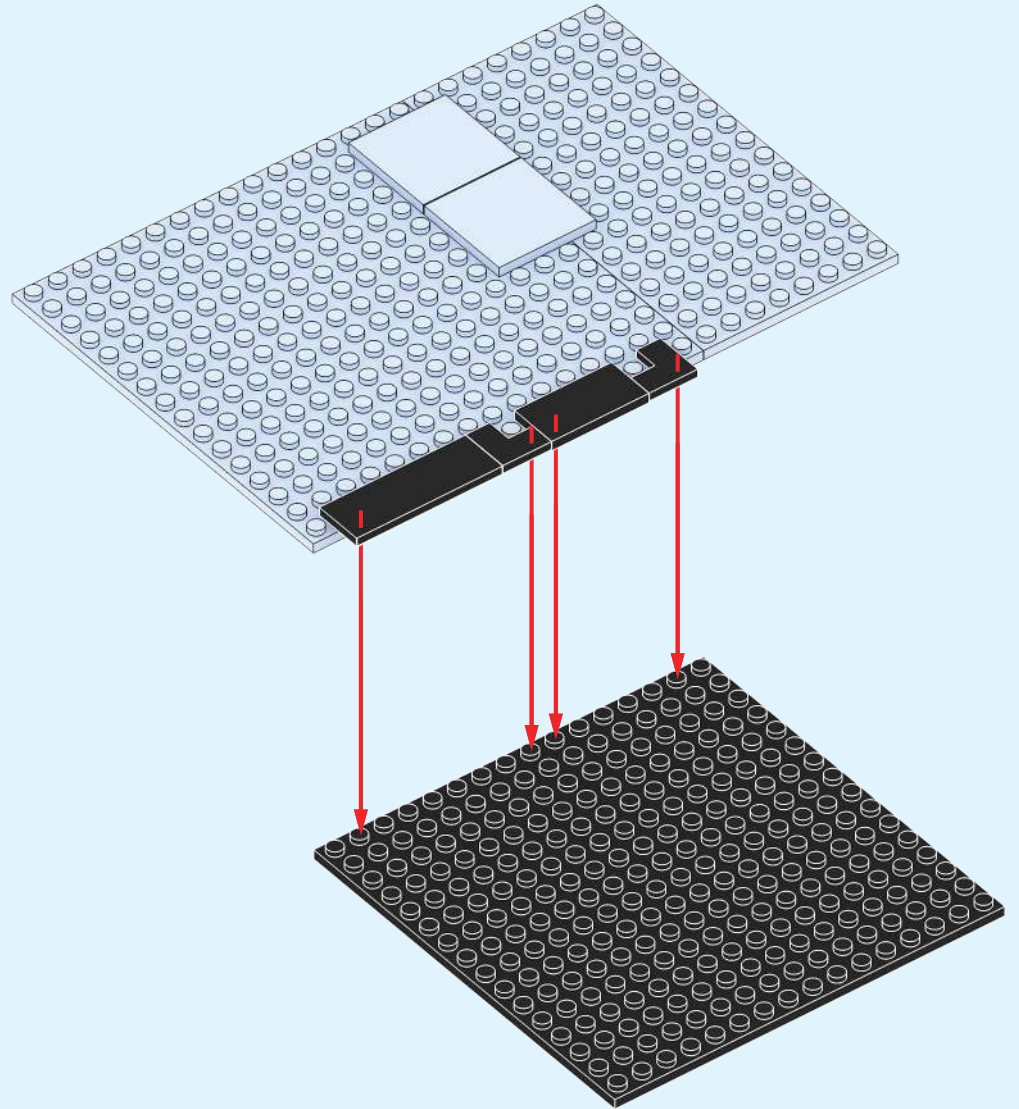

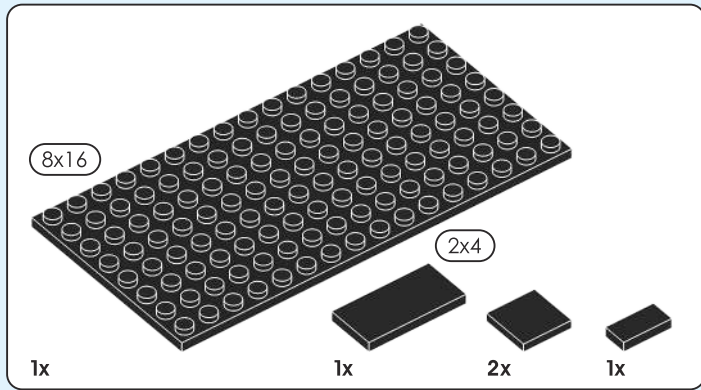

03

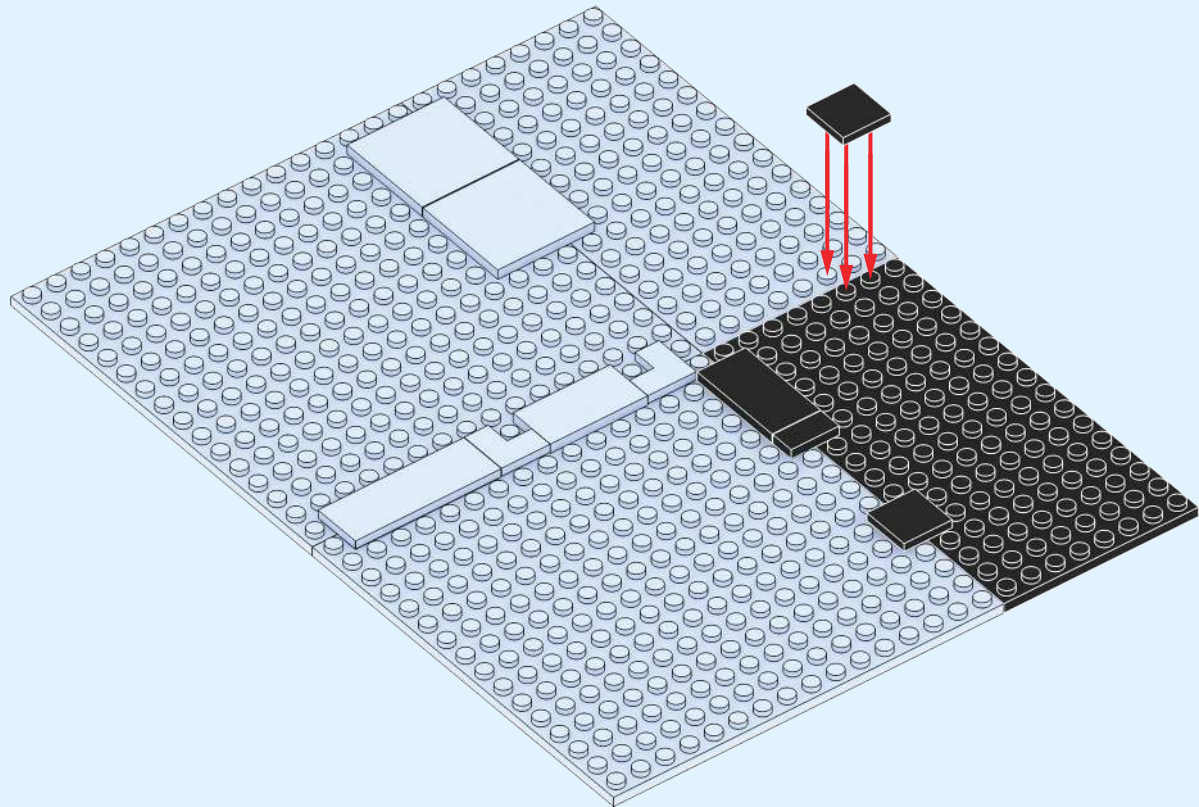

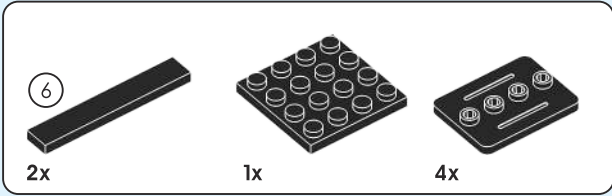

| 04 |

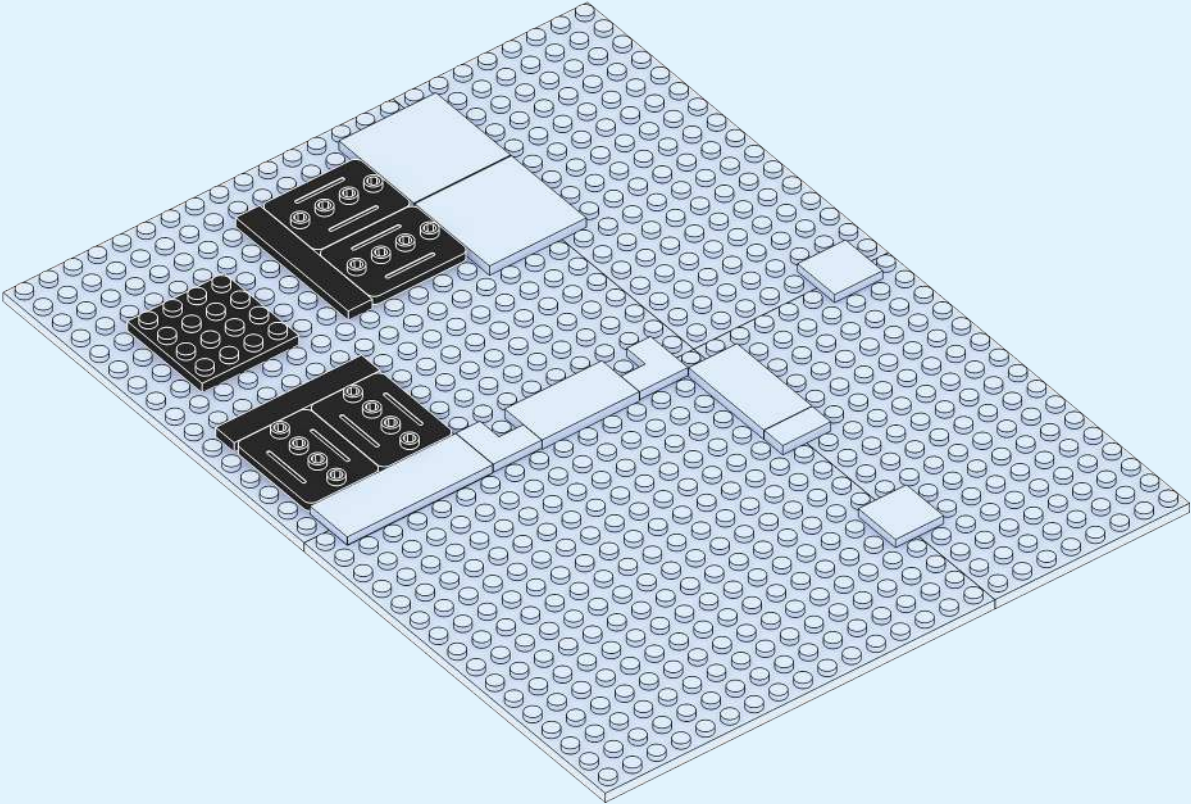

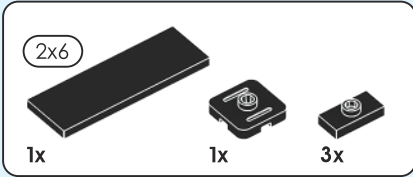

05

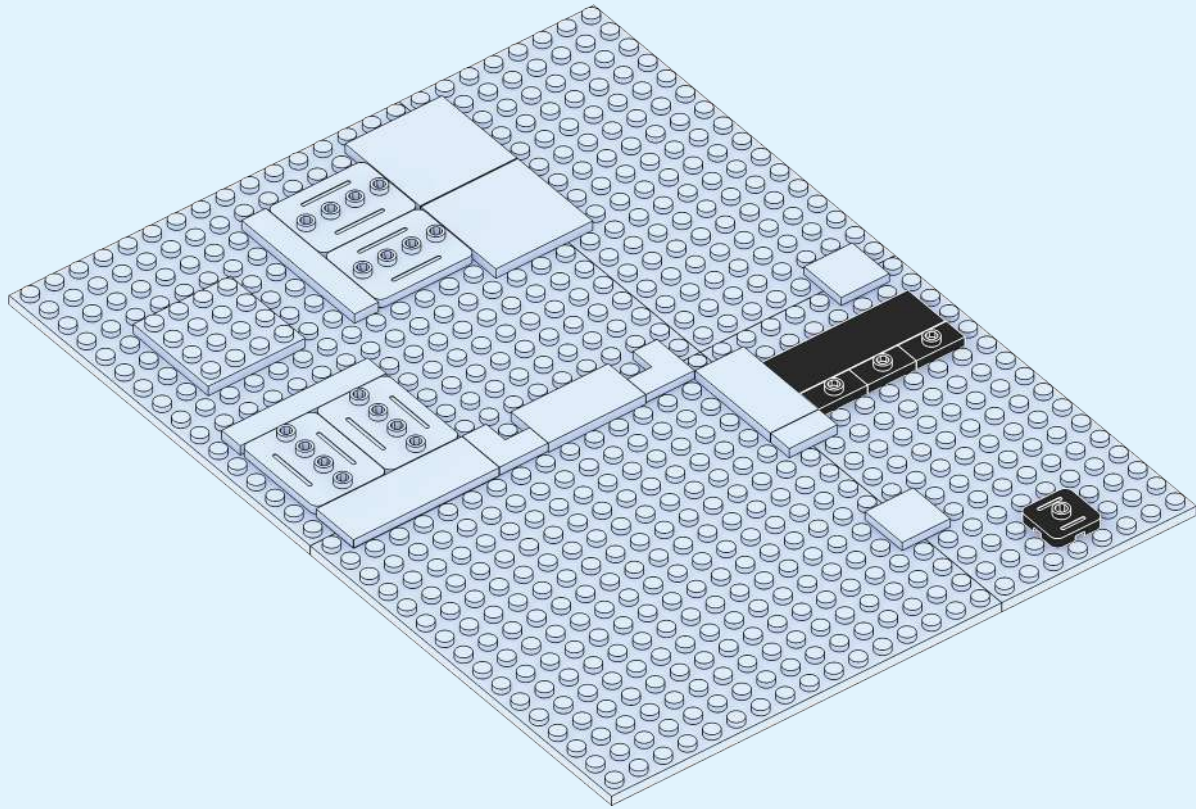

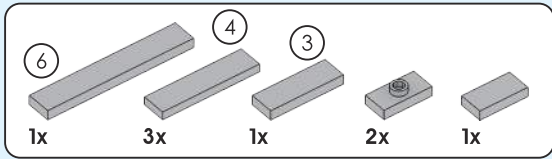

| 07 |

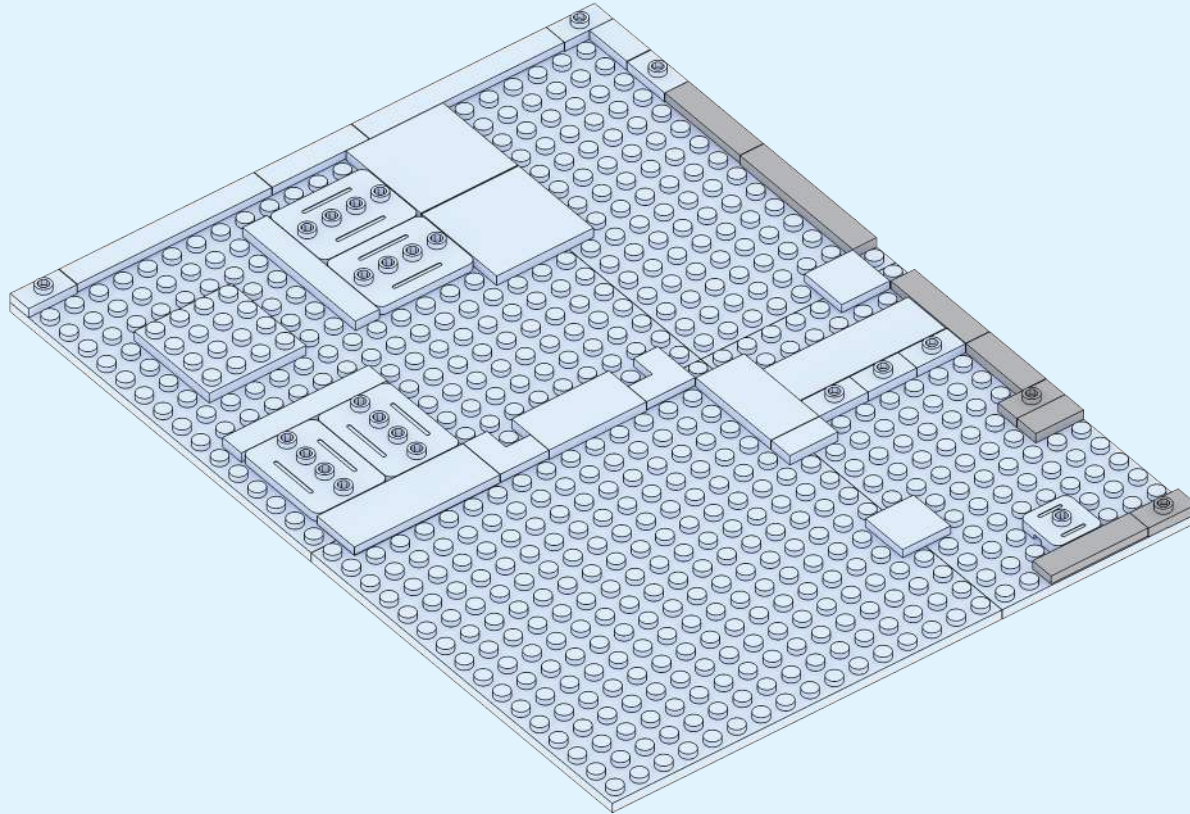

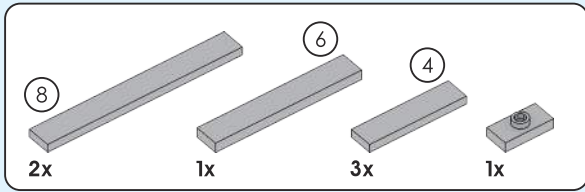

| 08 |

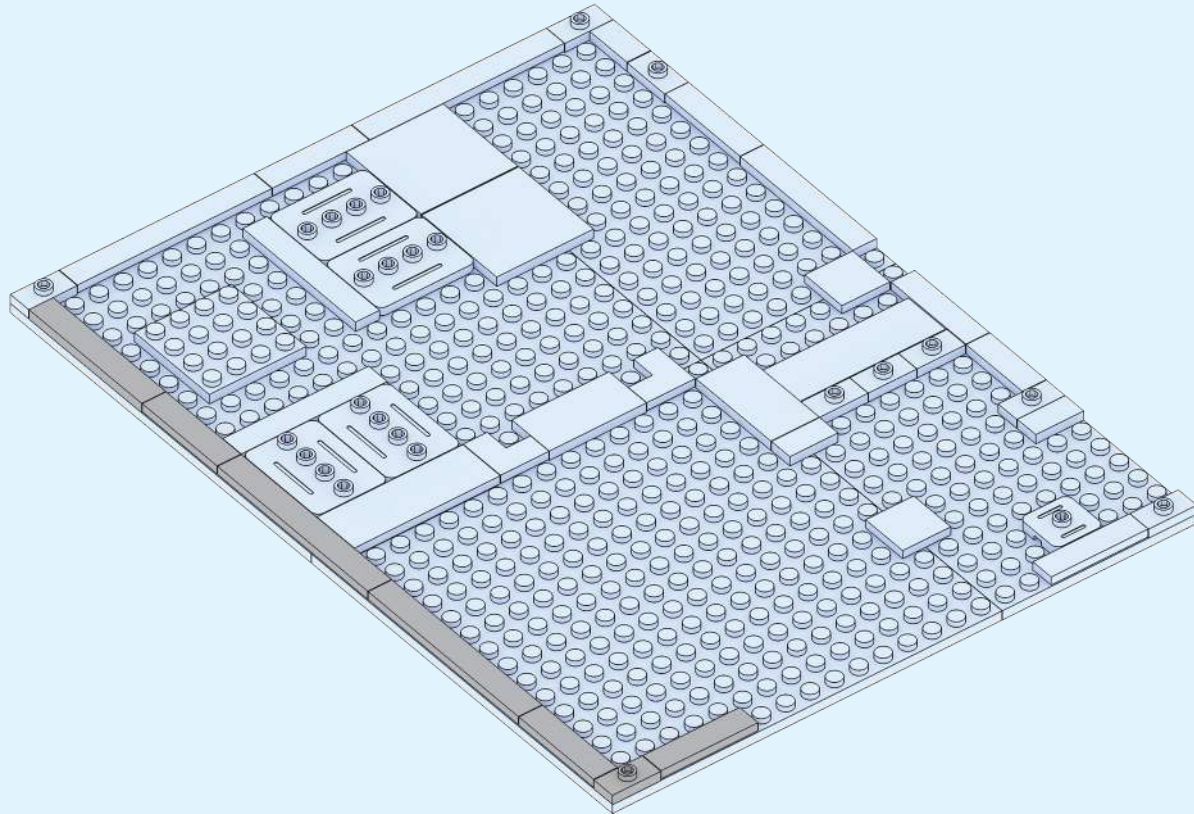

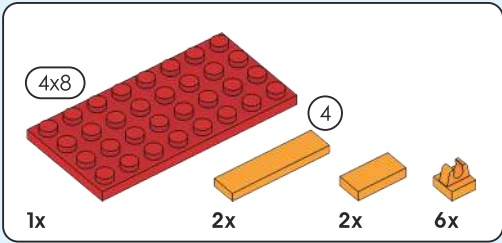
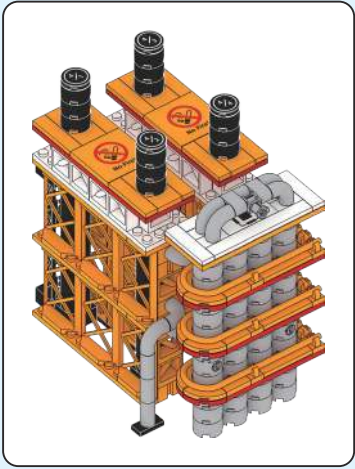

| 09 |

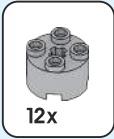
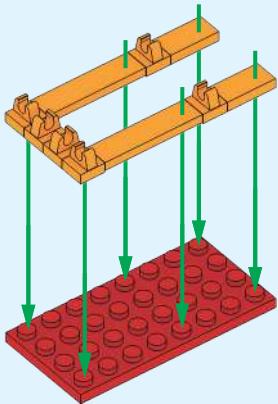

| 10 |

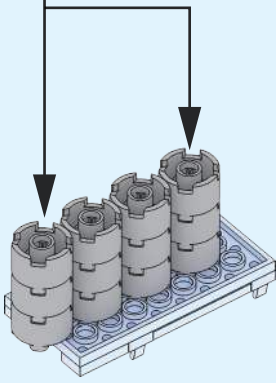
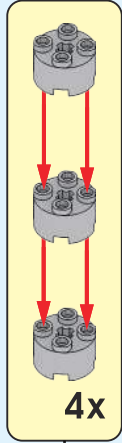

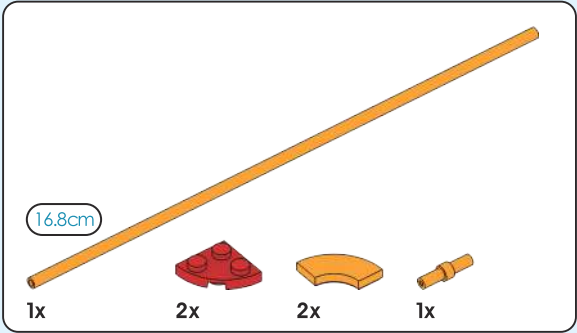

11

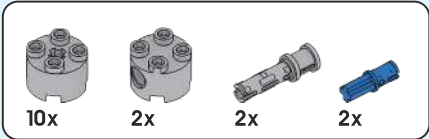
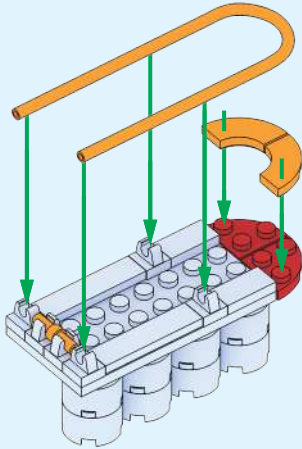

12

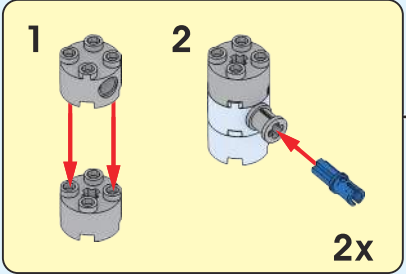
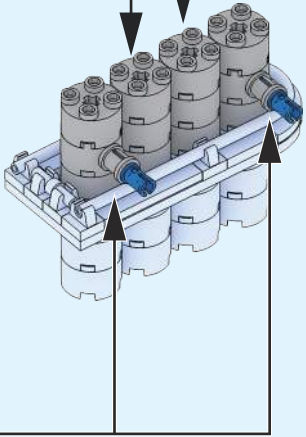
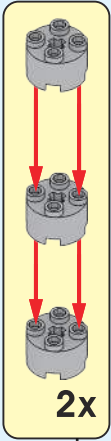

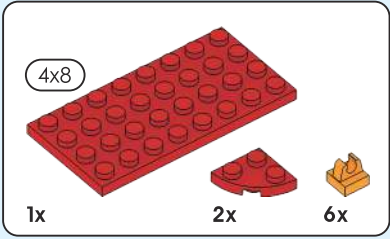

13

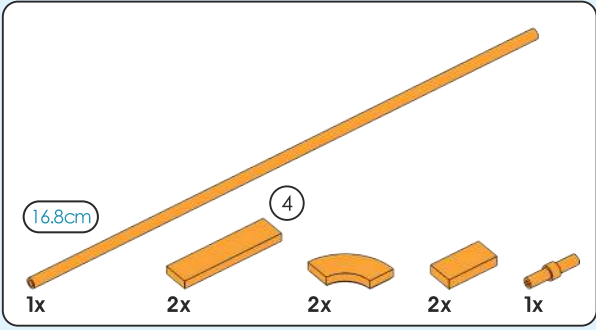
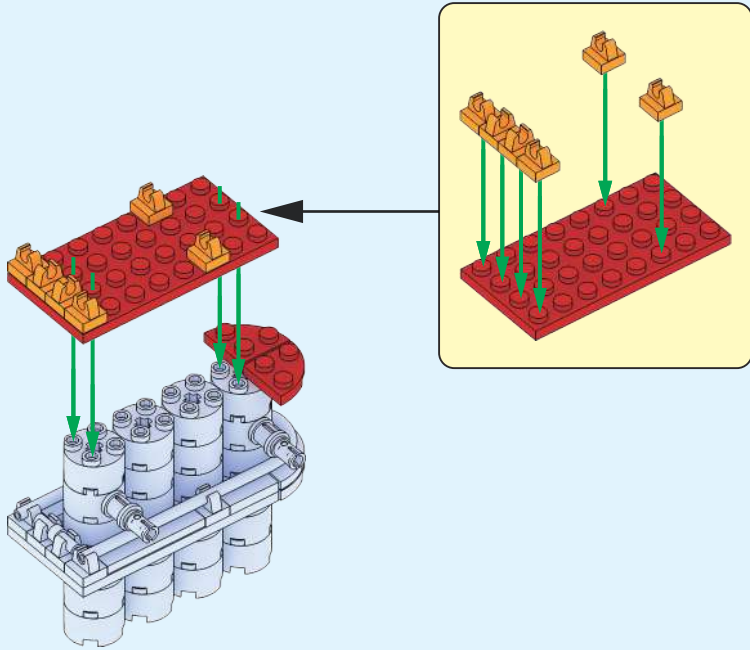

14

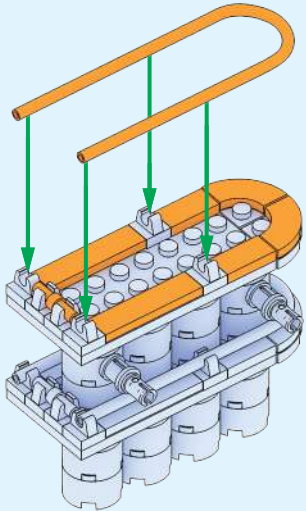

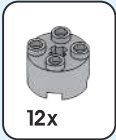

| 15 |

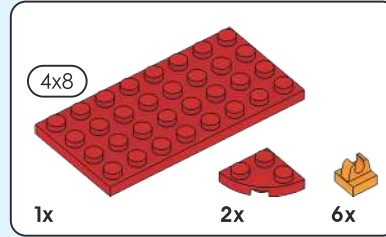
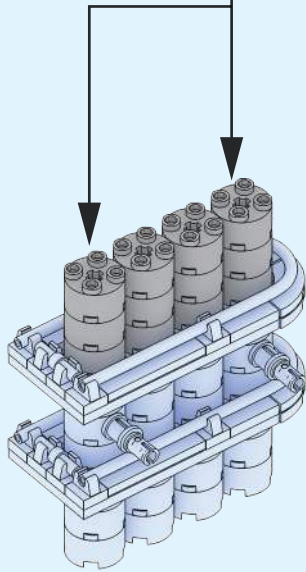
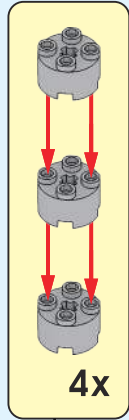

| 16 |

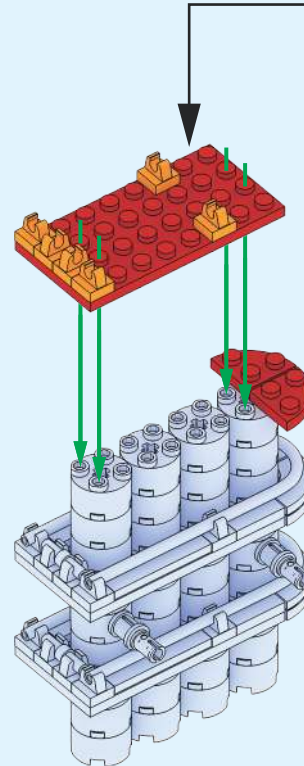
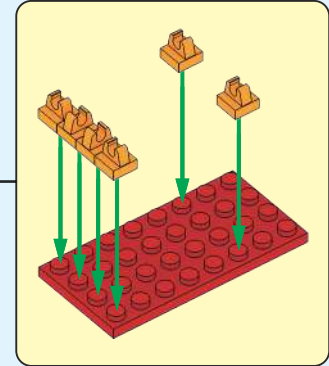

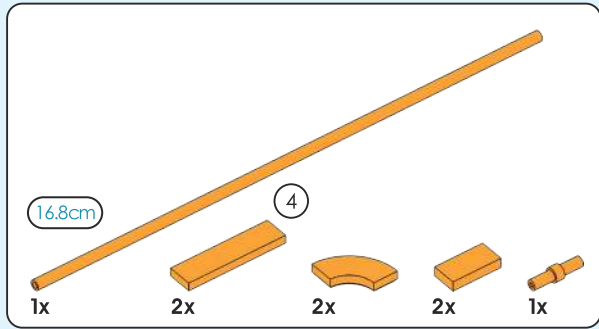

17

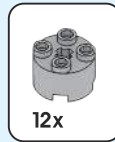
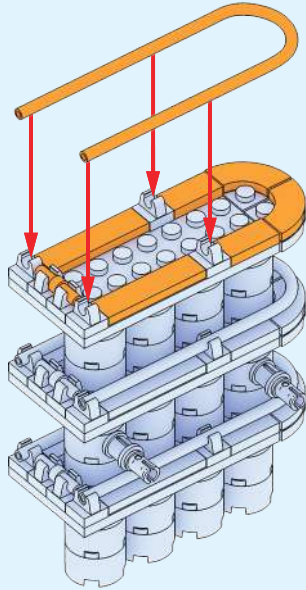

18

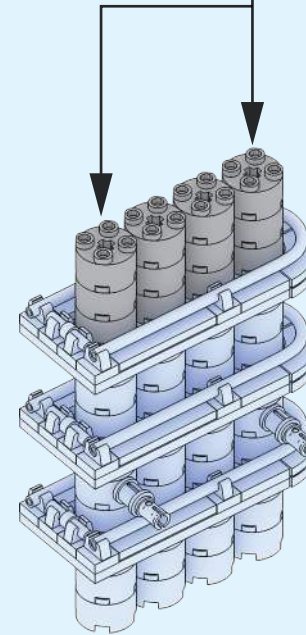
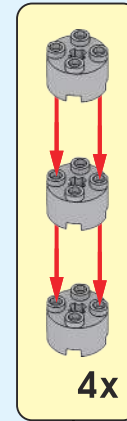

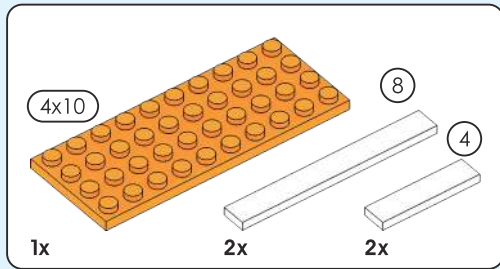

| 19 |

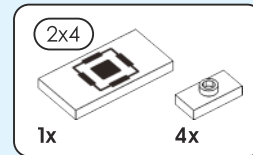
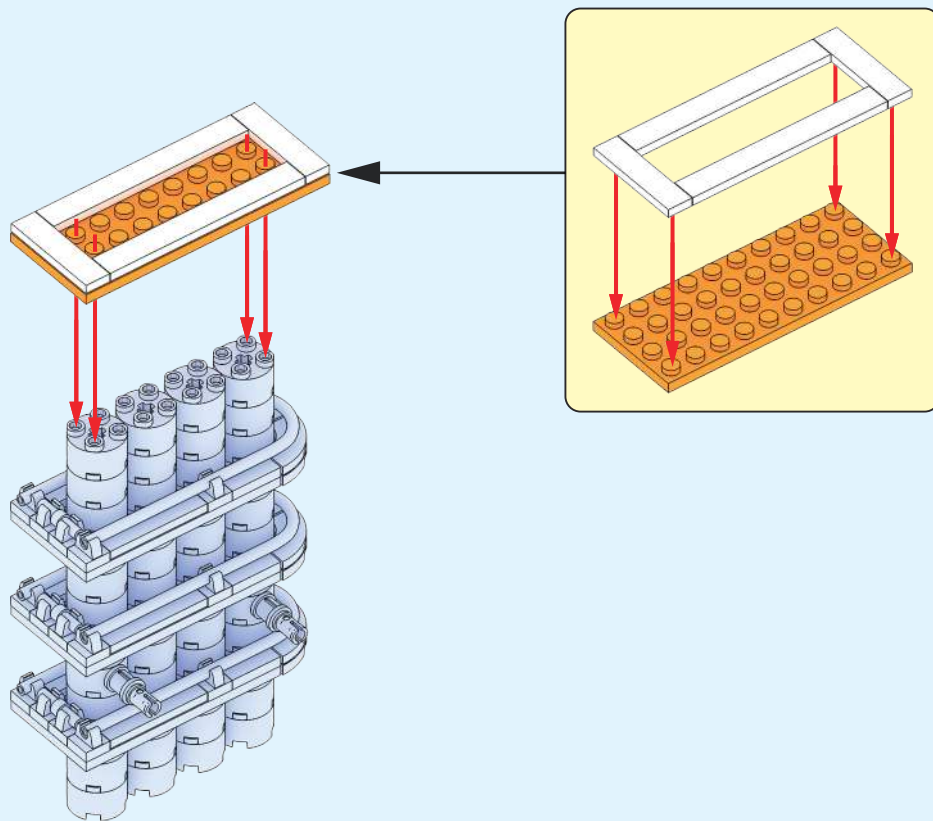

| 20 |

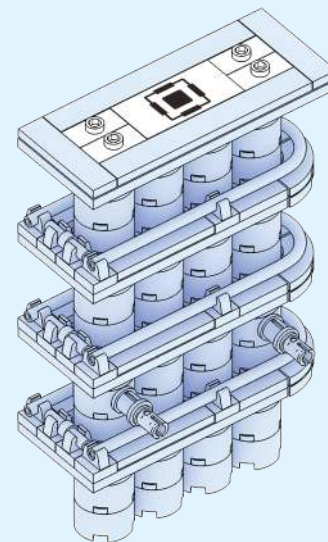

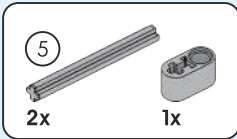

| 21 |

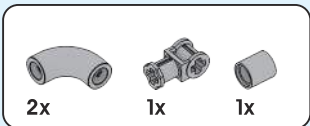
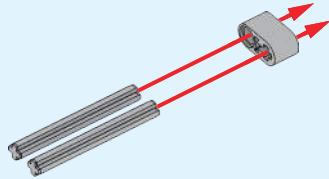

| 22 |

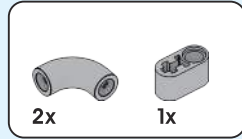
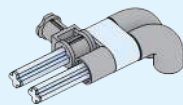

| 23 |

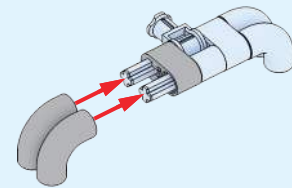

| 24 |

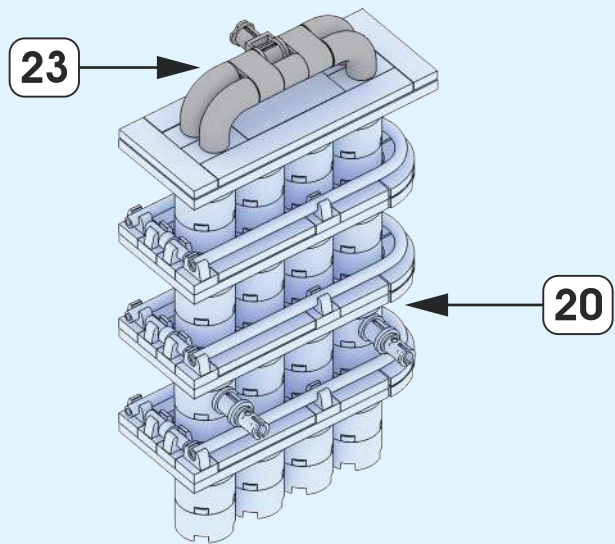

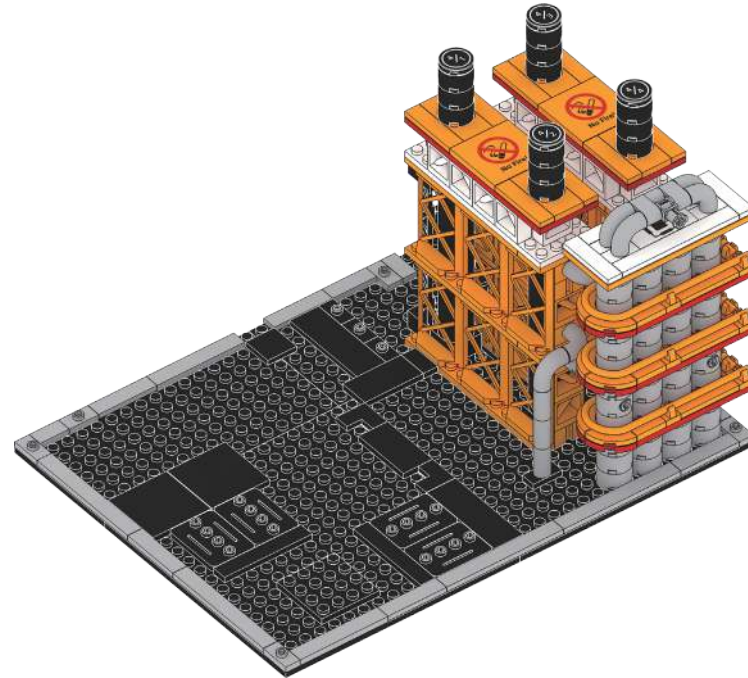
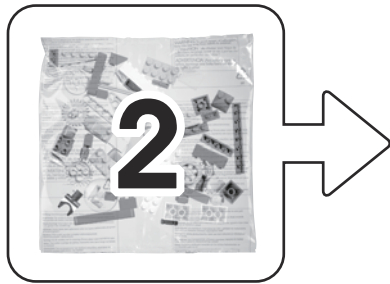

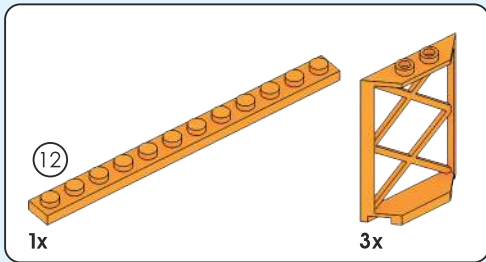
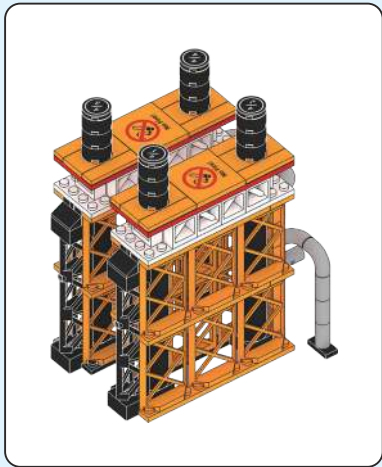

| 25 |

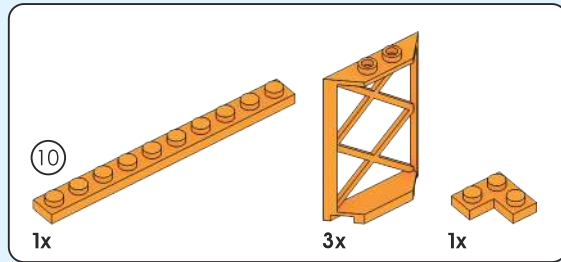
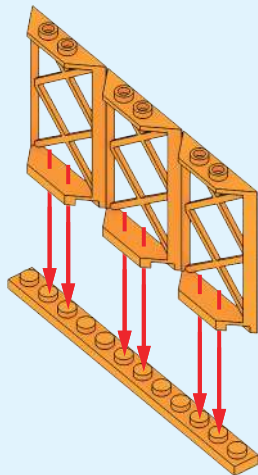

| 26 |

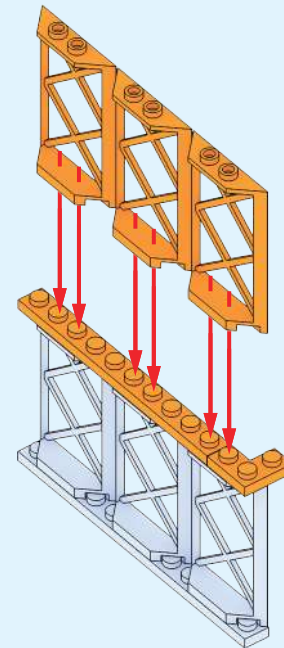

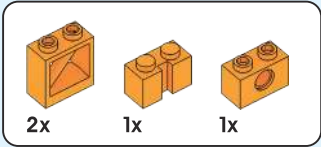

| 27 |

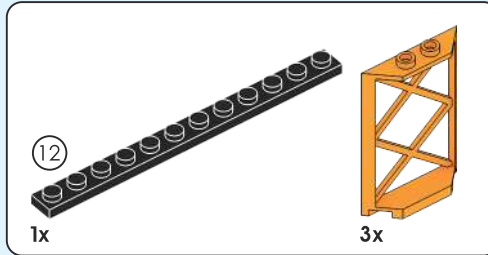
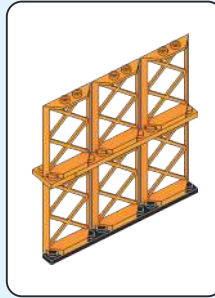
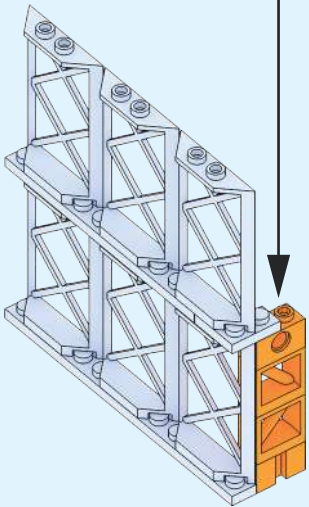
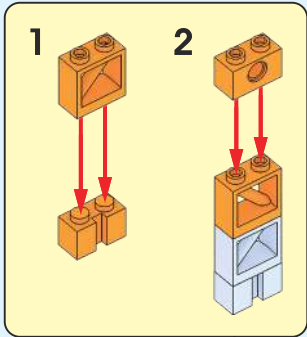

| 28 |

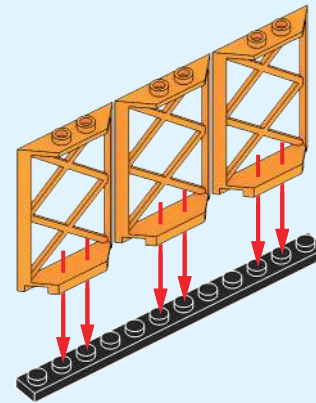

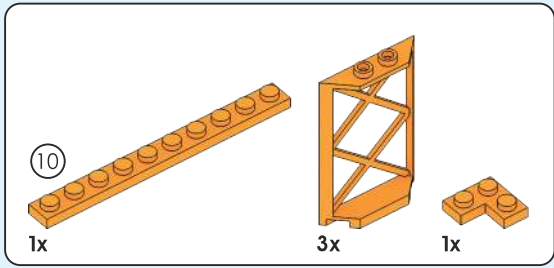

| 29 |

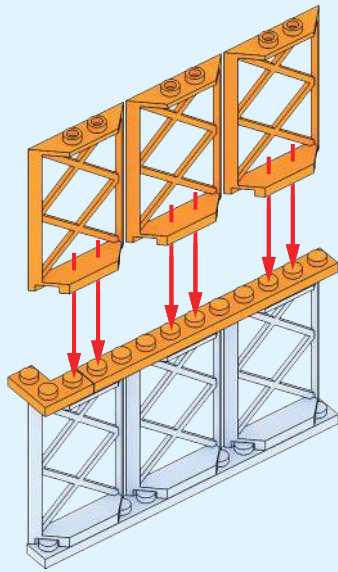

| 30 |

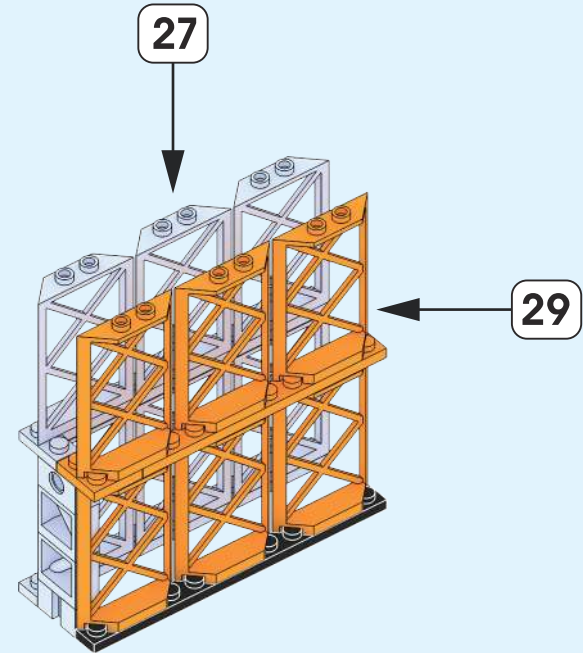

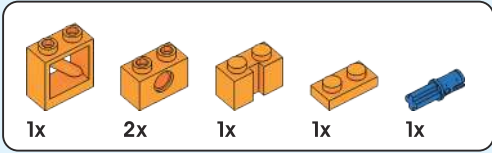

31

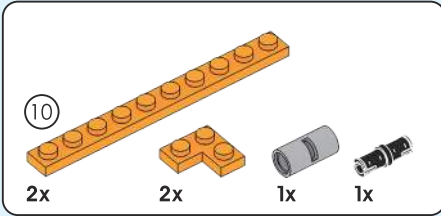
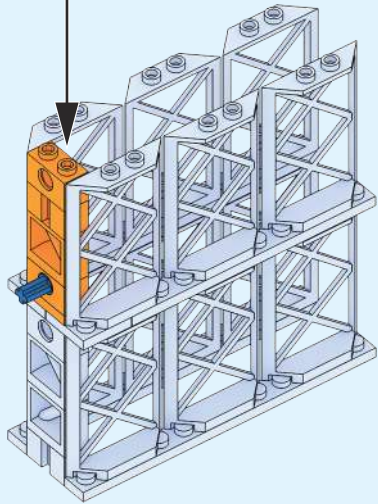
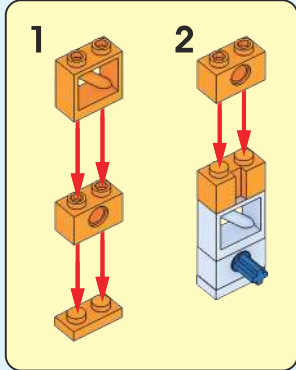

32

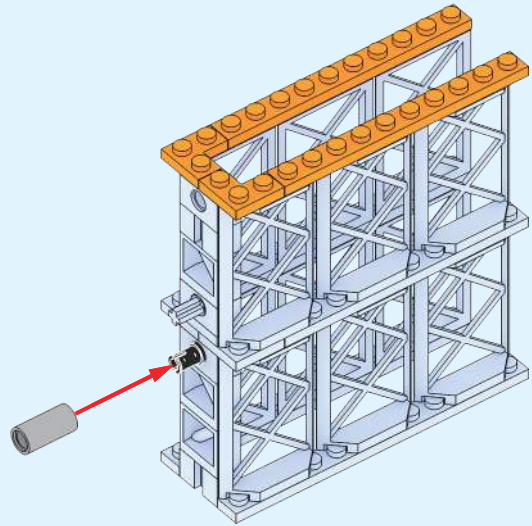

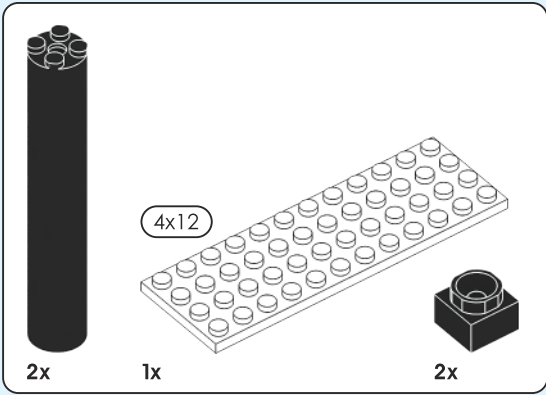
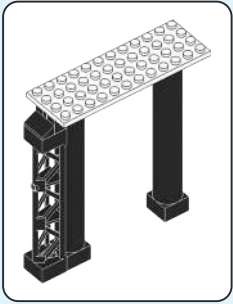

33

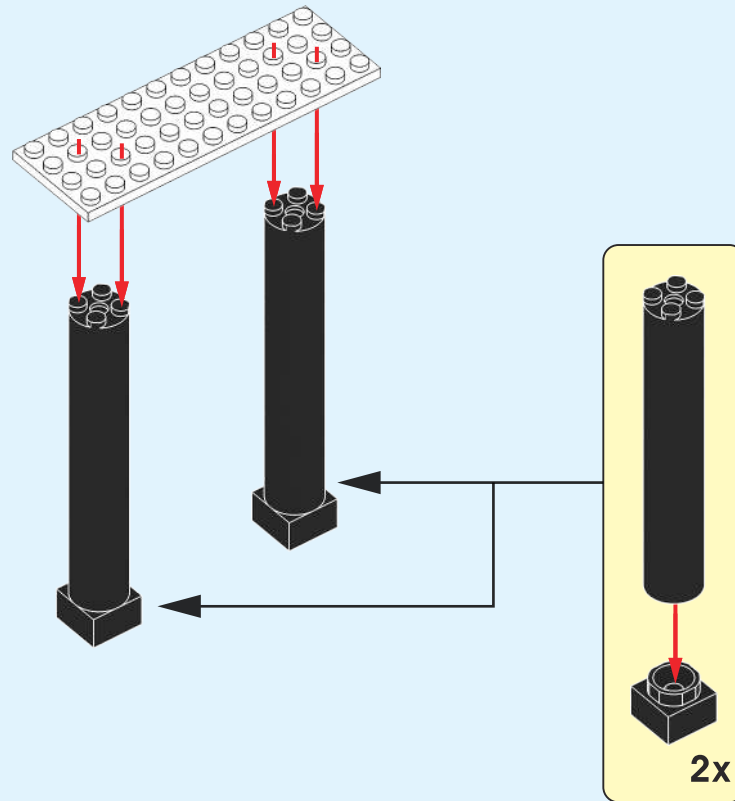

22

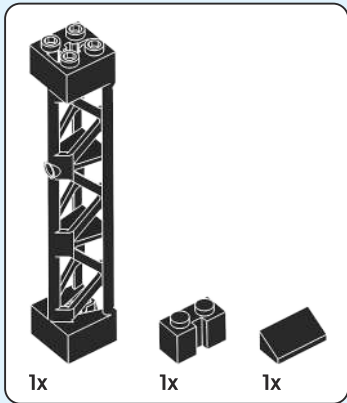

| 34 |

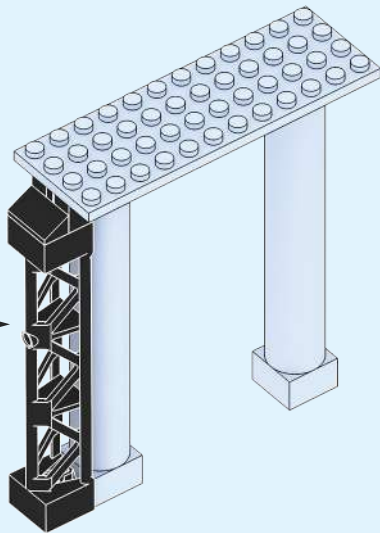
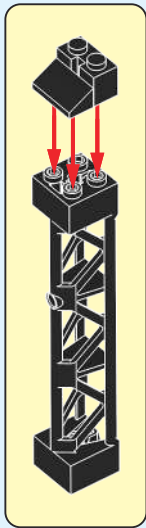

| 35 |



34

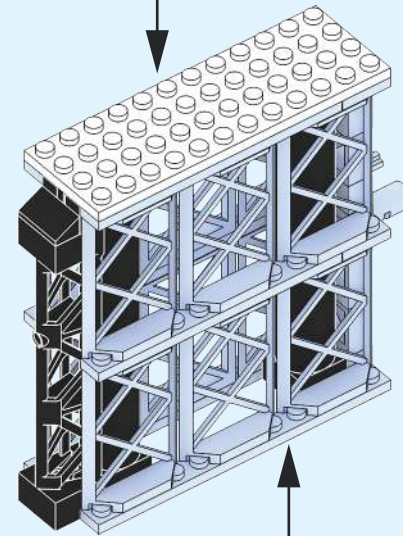

32

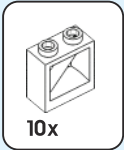

36

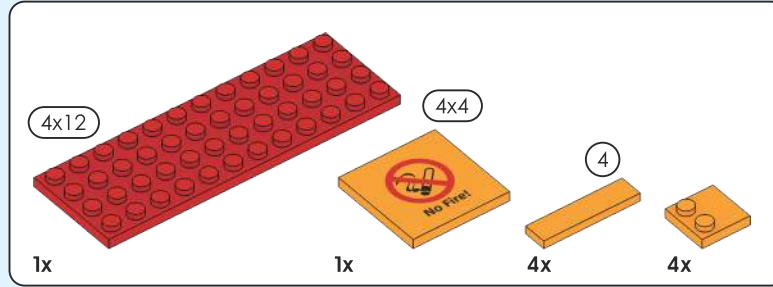
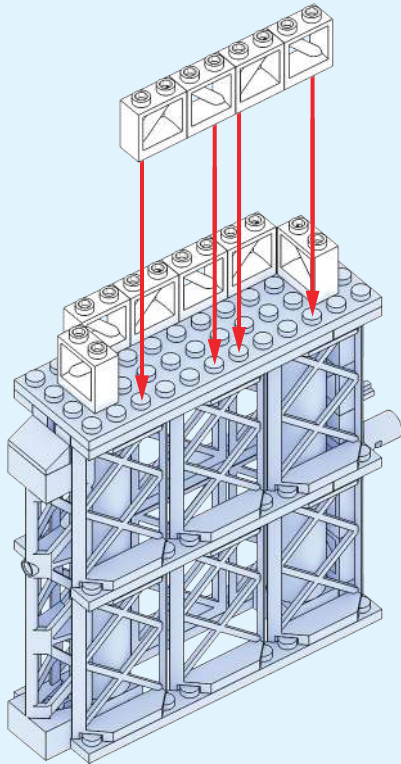

37

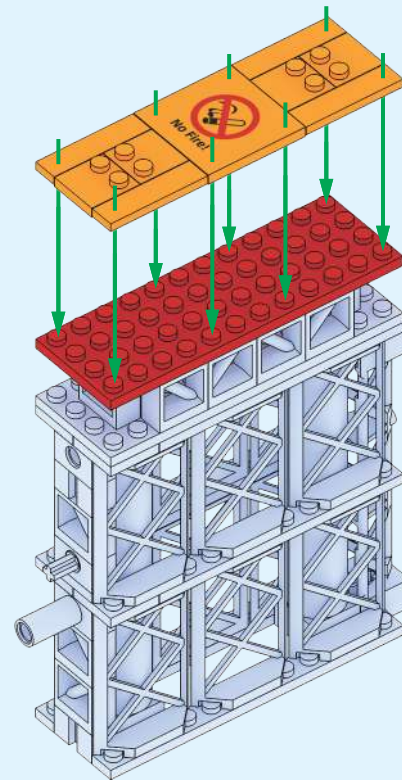

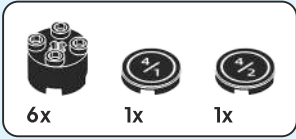

38

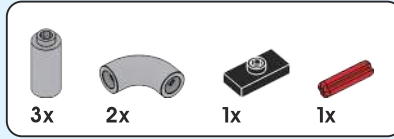
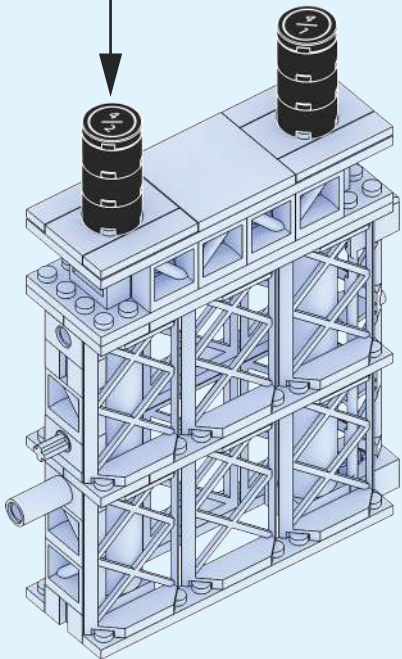
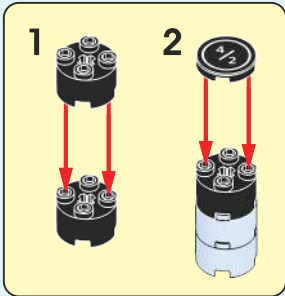
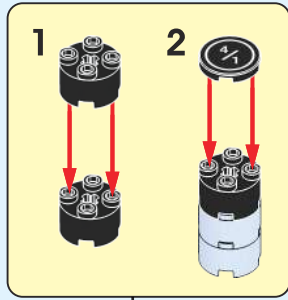

39

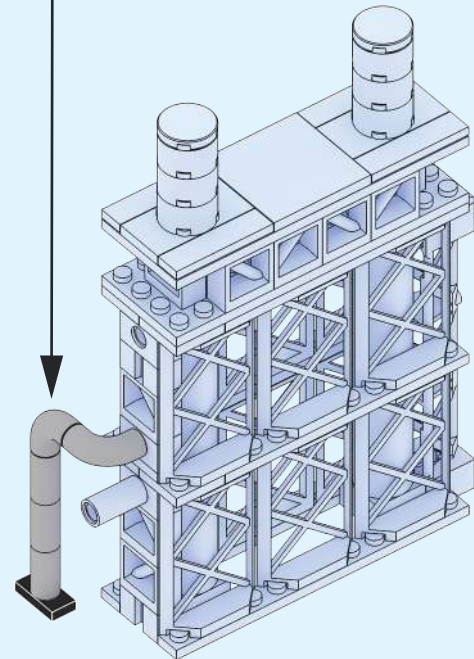
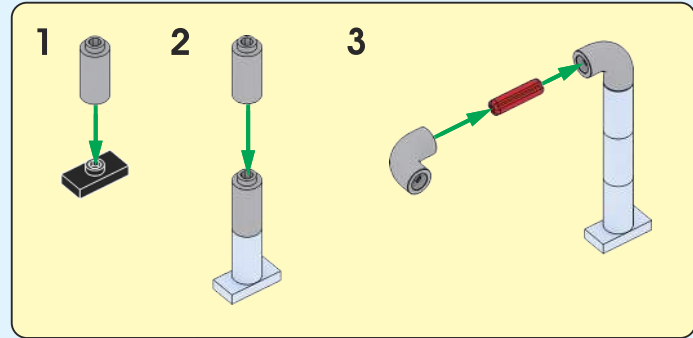

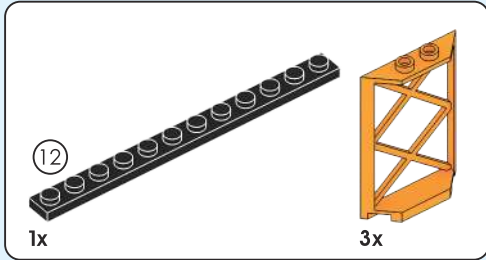
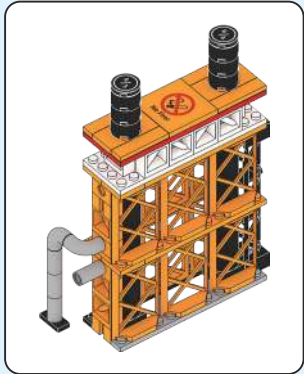

| 40 |

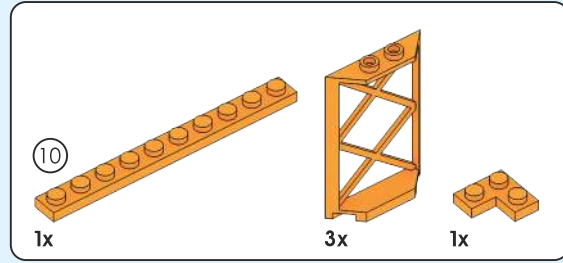
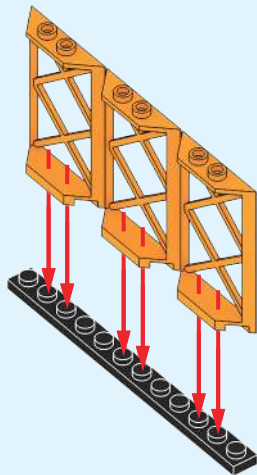

| 41 |

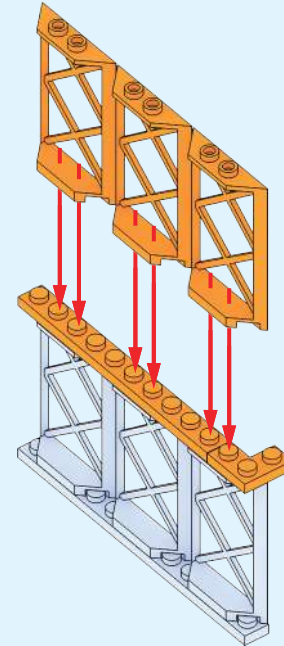

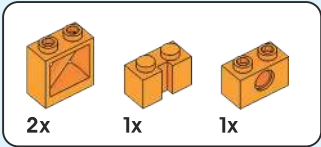

| 42 |

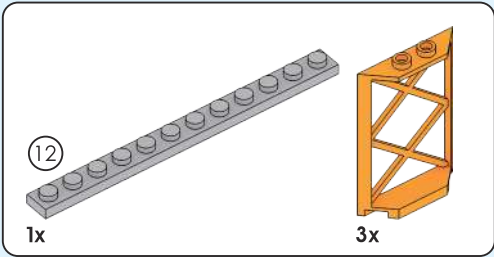
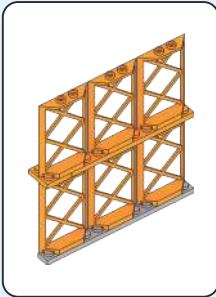
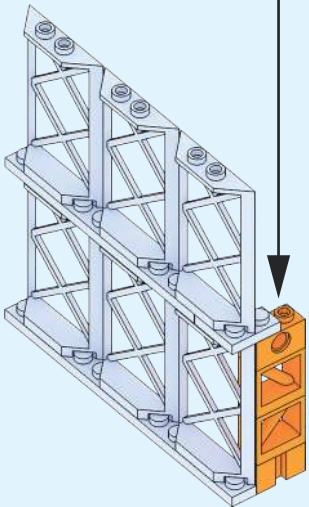
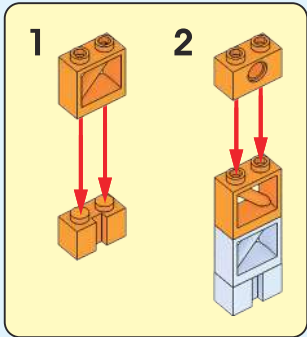

| 43 |

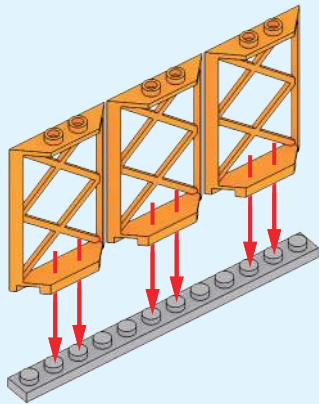

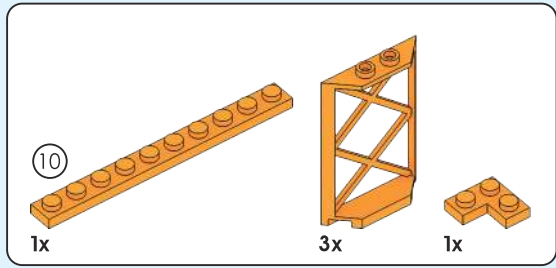

| 44 |

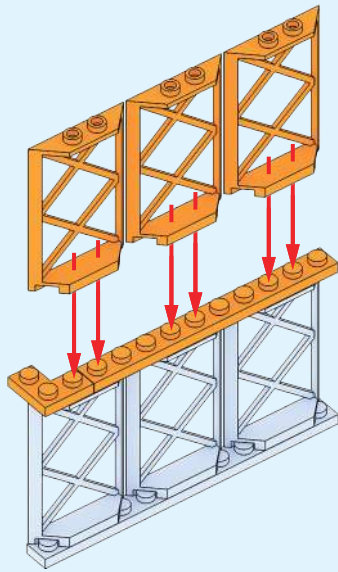

| 45 |

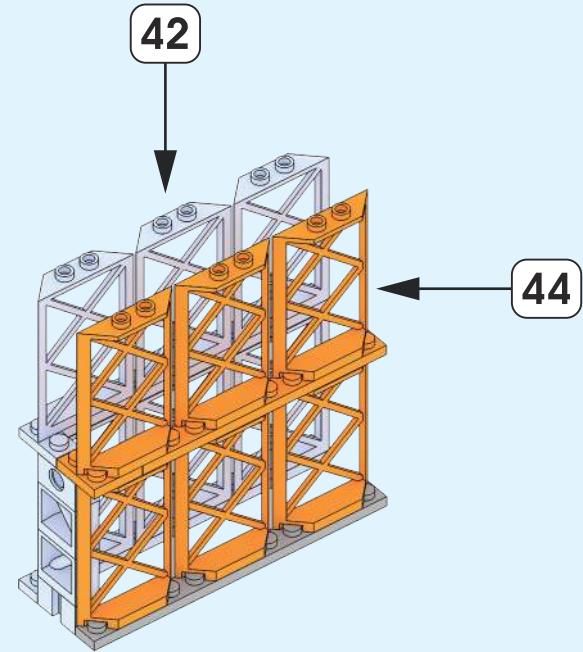

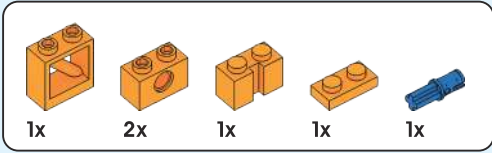

46

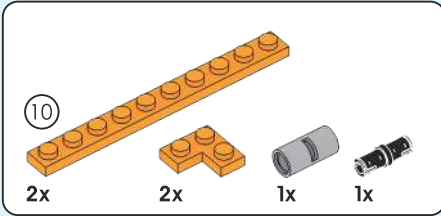
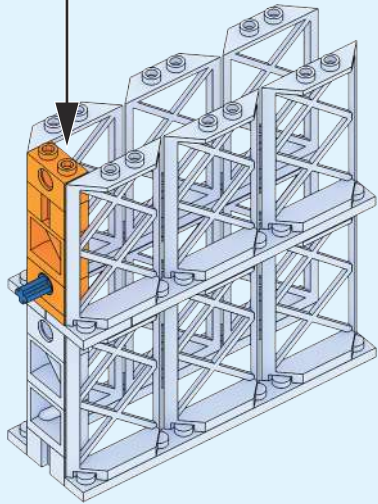
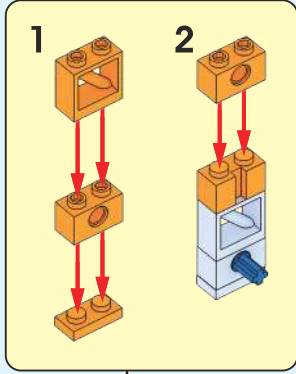

47

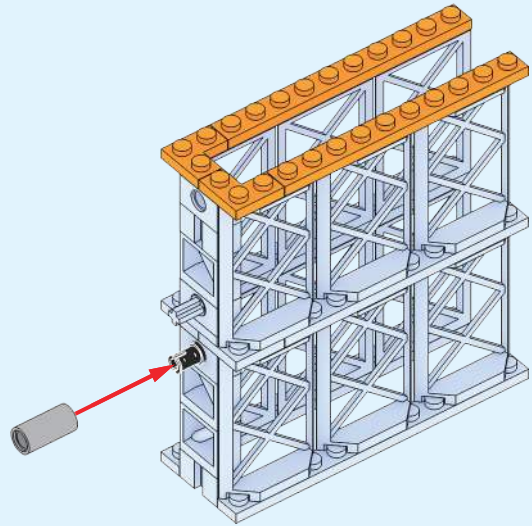

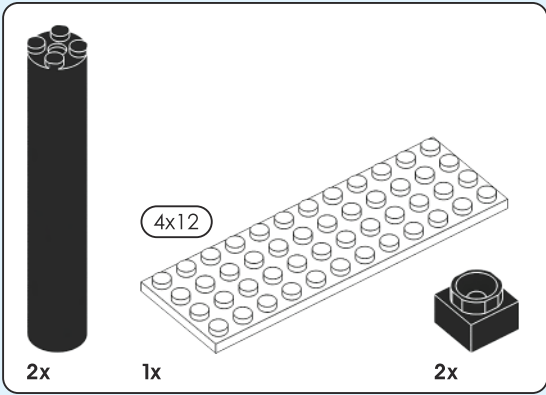
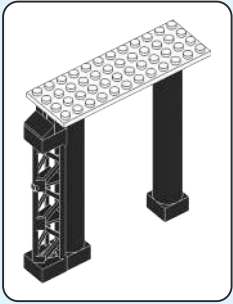

48

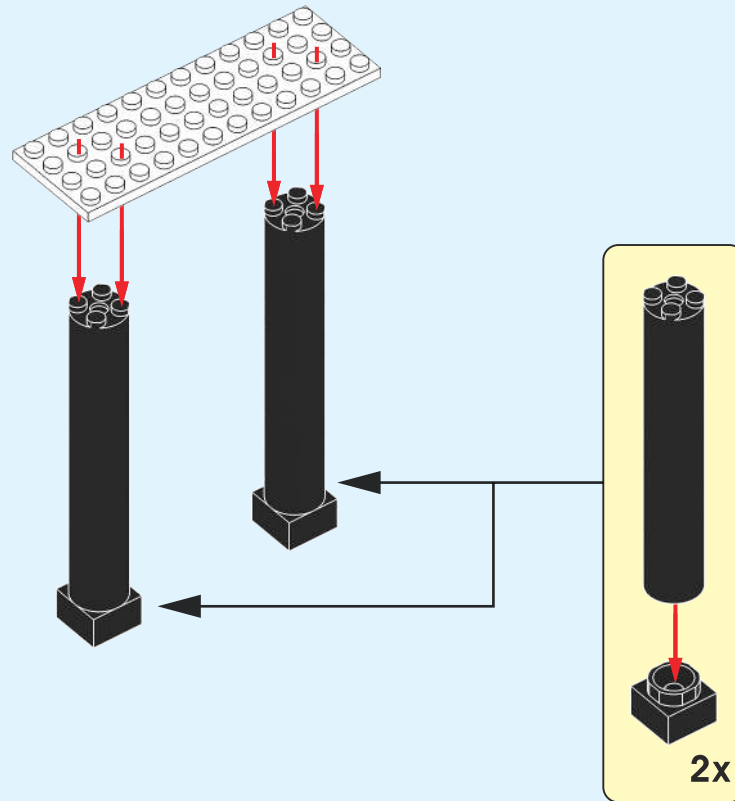

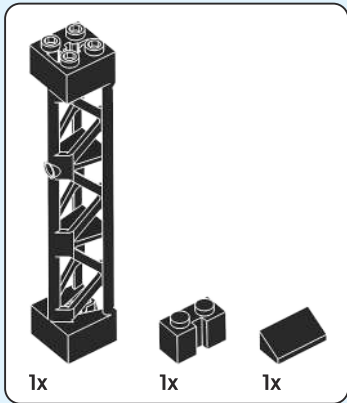

| 49 |

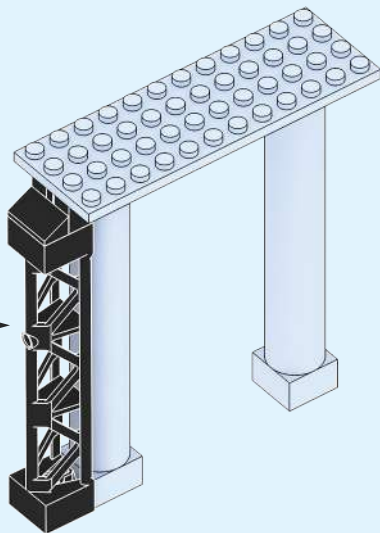
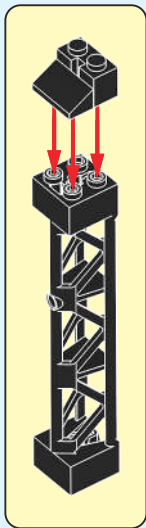

| 50 |



49

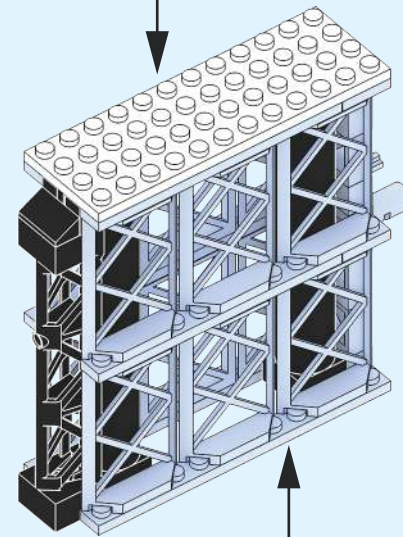

47

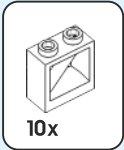

10x

51

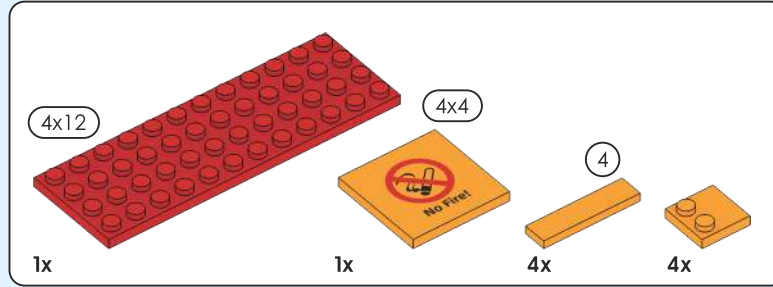
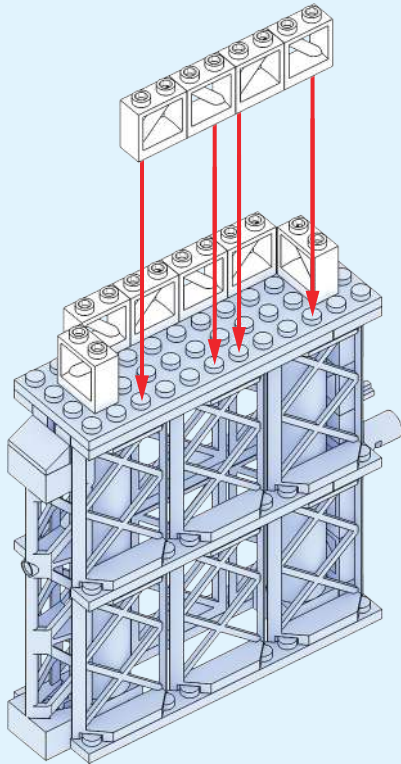

52

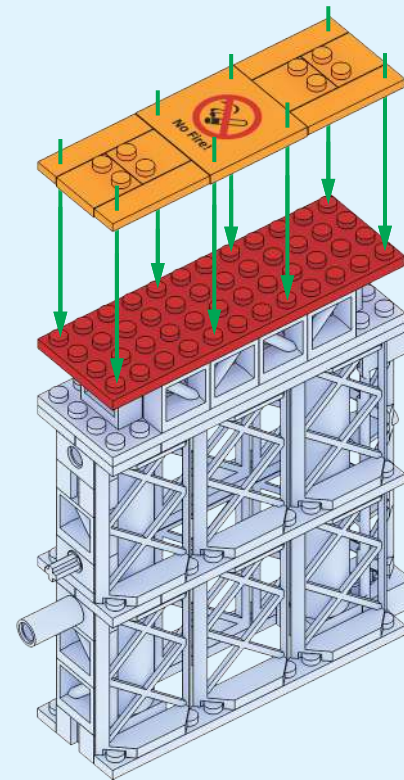

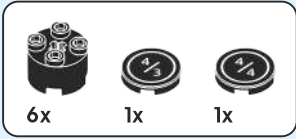

53

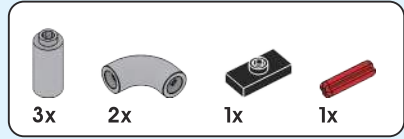
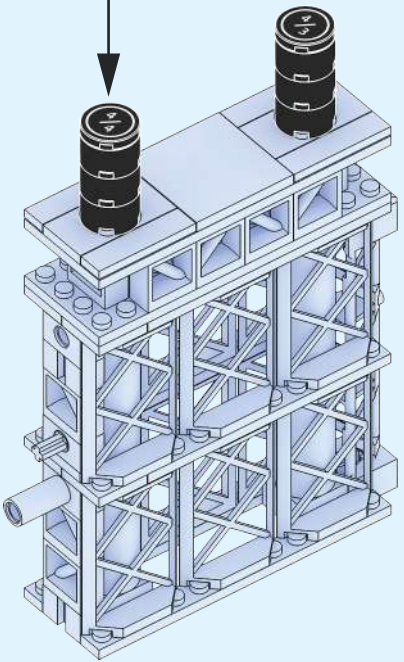
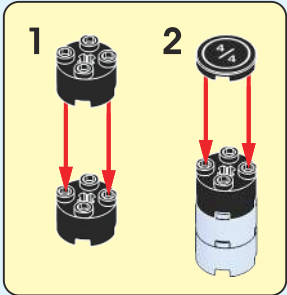
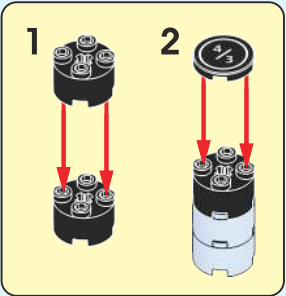

54

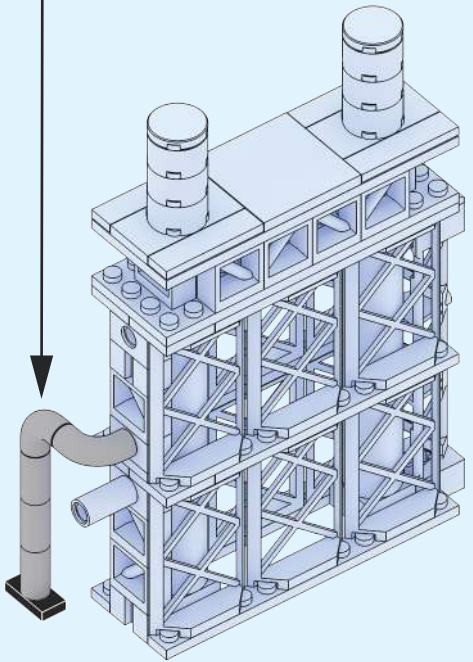
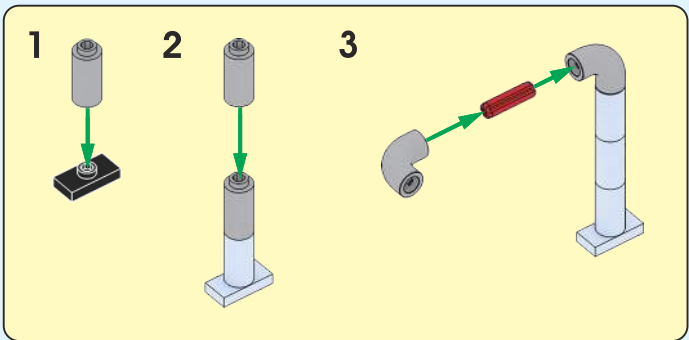

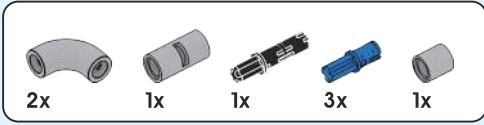

55

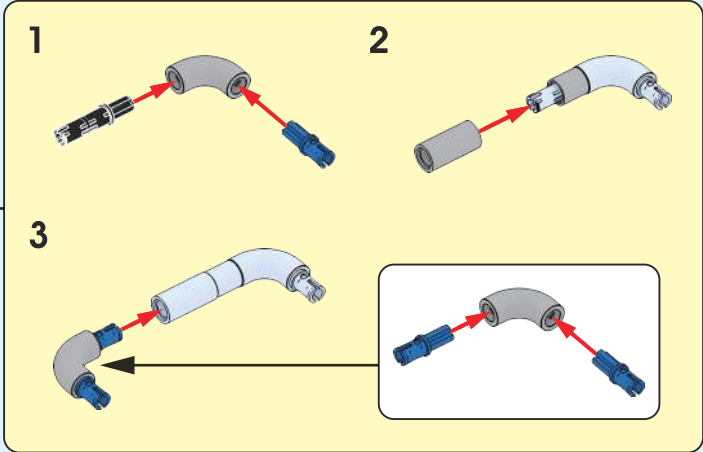
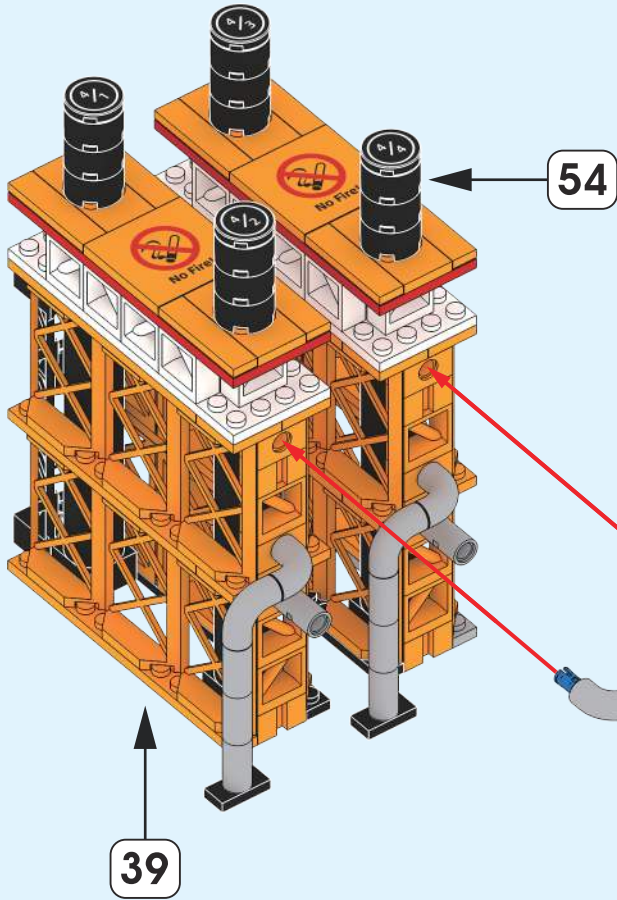

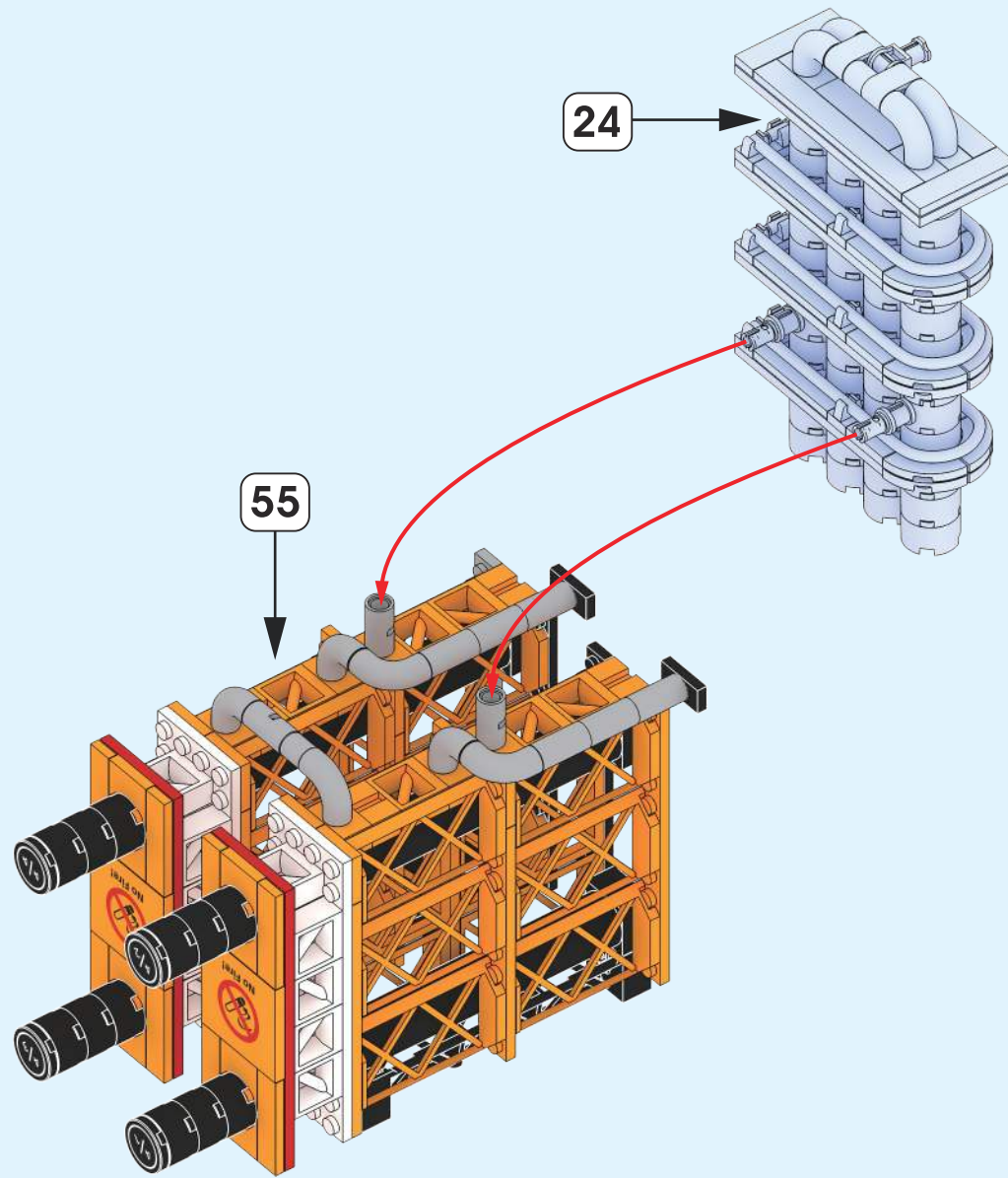

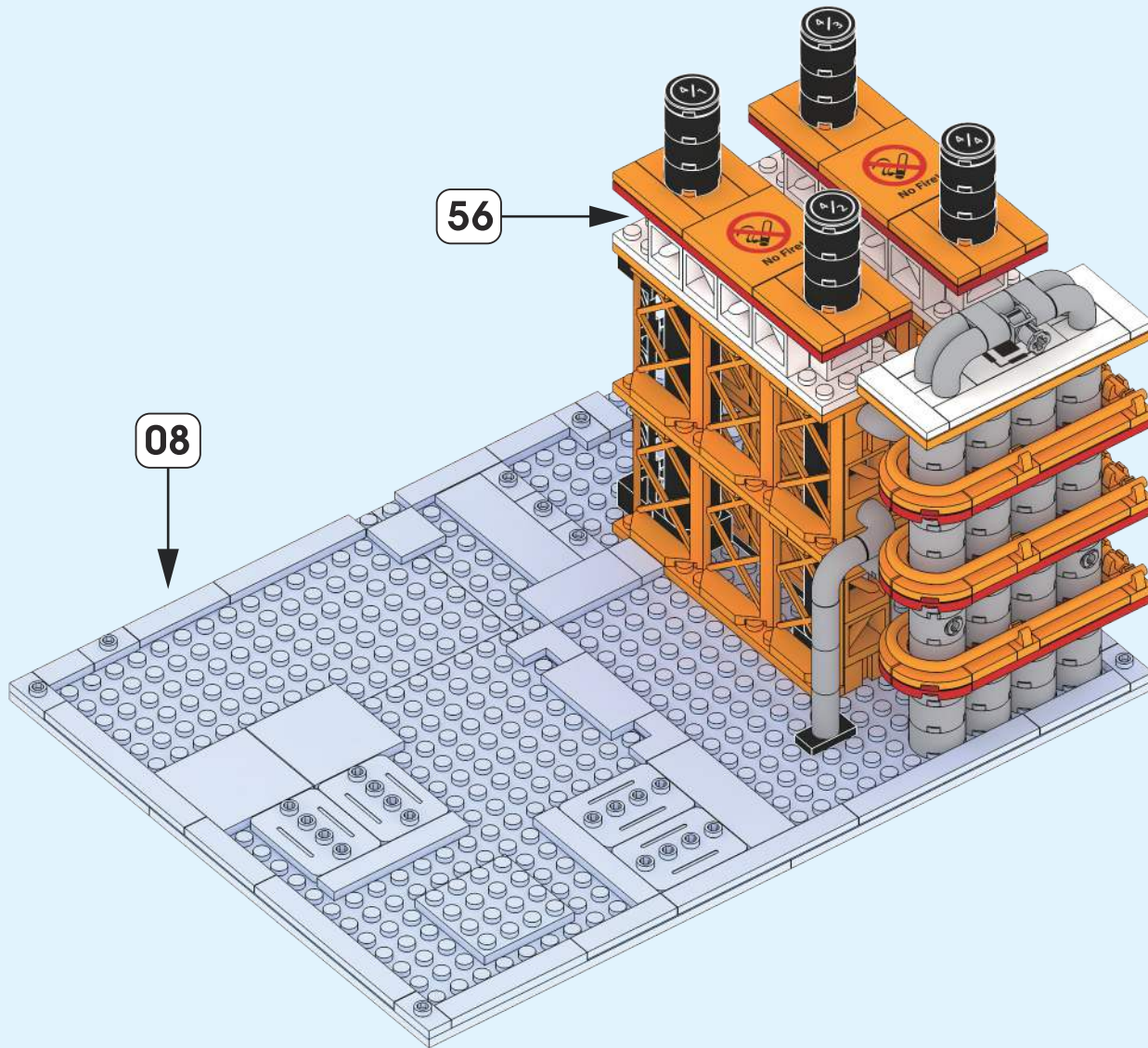

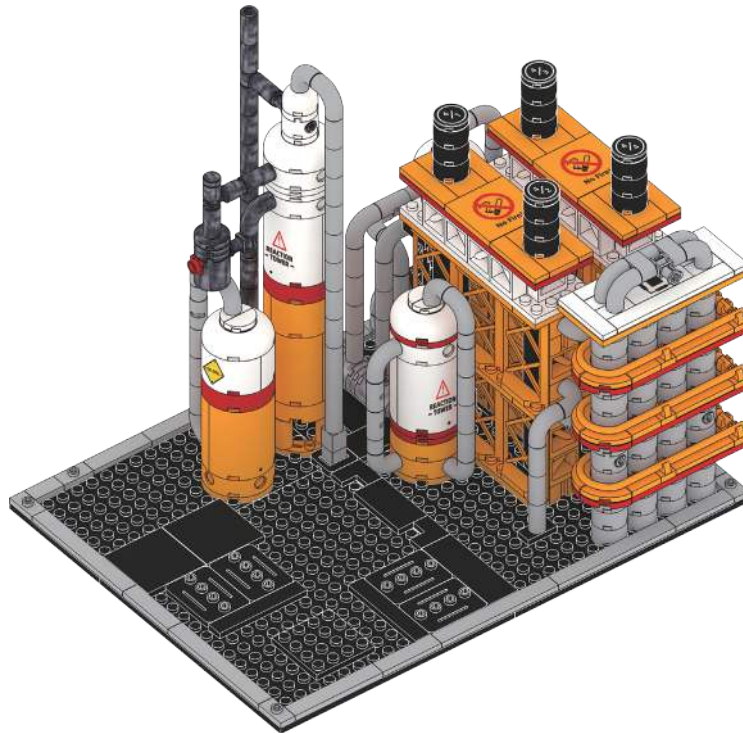
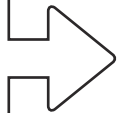

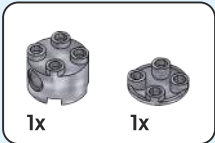

| 58 |

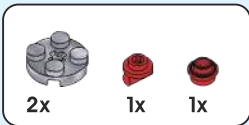

| 59 |

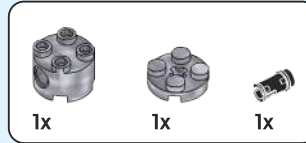
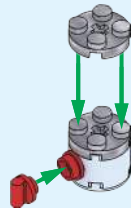

| 60 |

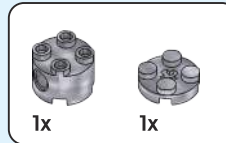
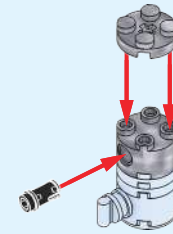

| 61 |

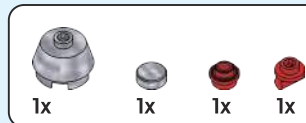
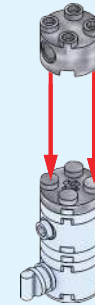

| 62 |

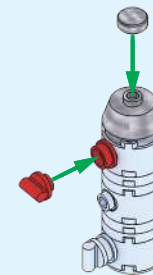



63

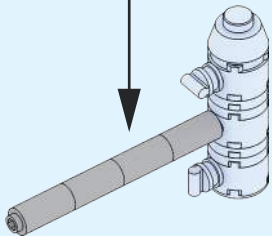
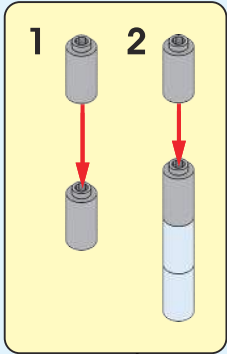

64

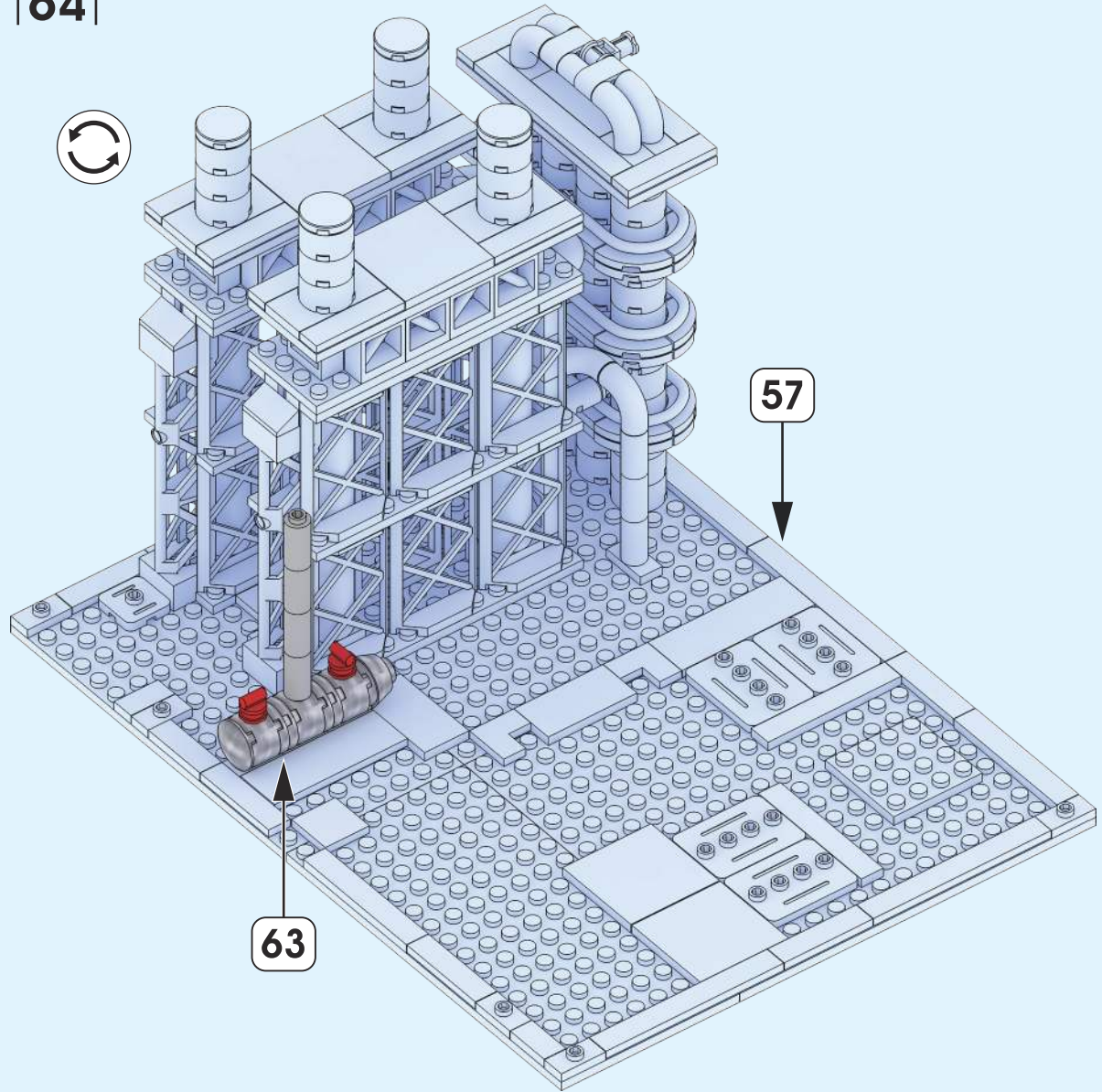

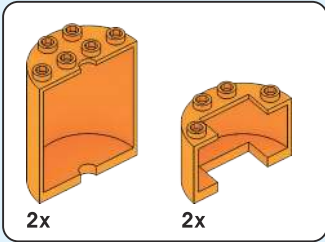
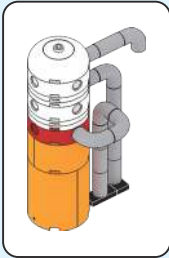

| 65 |

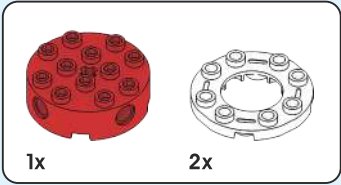
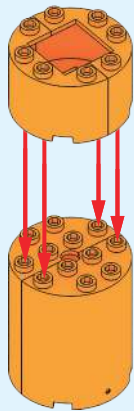

| 66 |

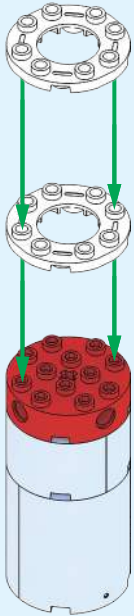

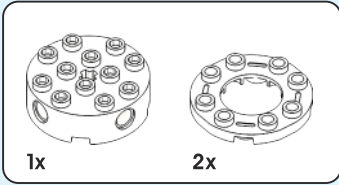

| 67 |

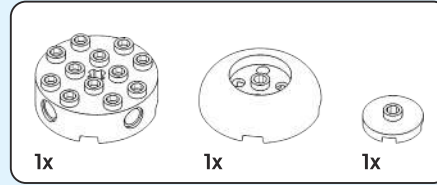
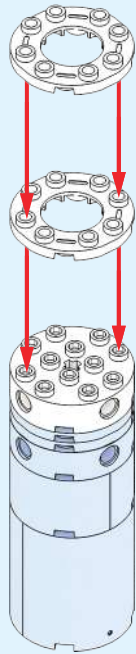

| 68 |

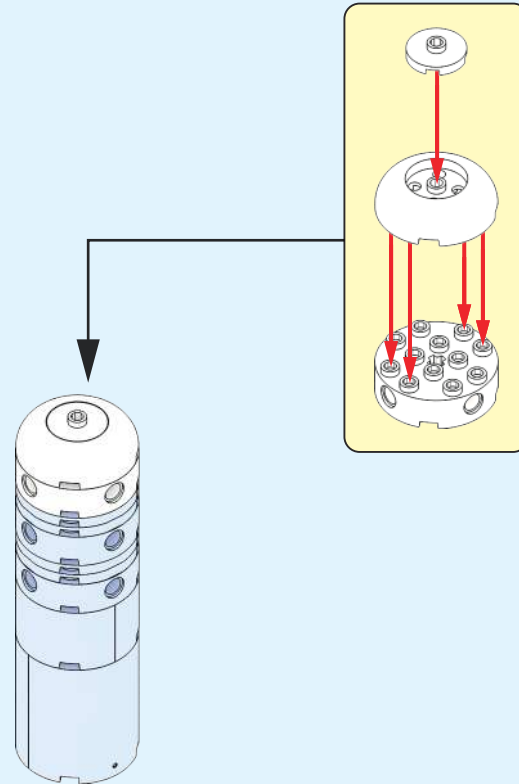

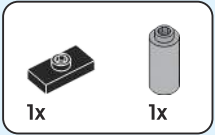
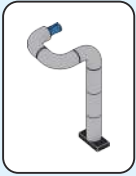

| 69 |

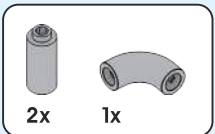
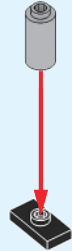

| 70 |

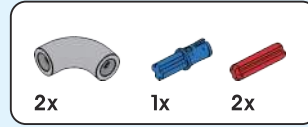
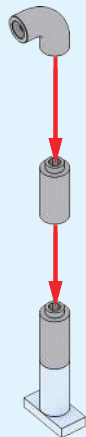

| 71 |

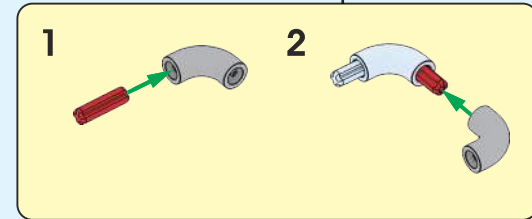
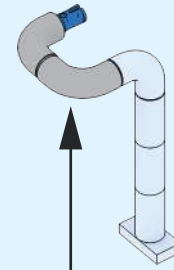

| 72 |

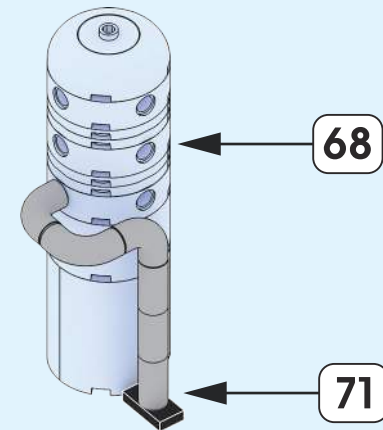

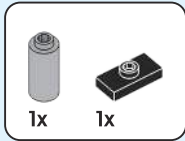
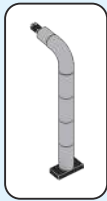

| 73 |

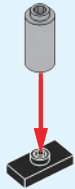

| 74 |

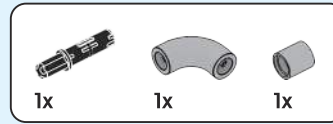
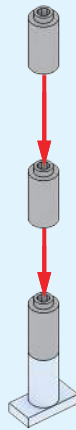

| 75 |

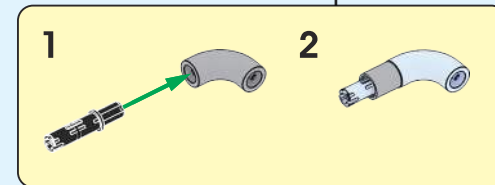
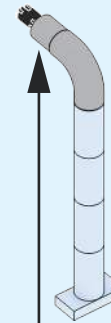

| 76 |

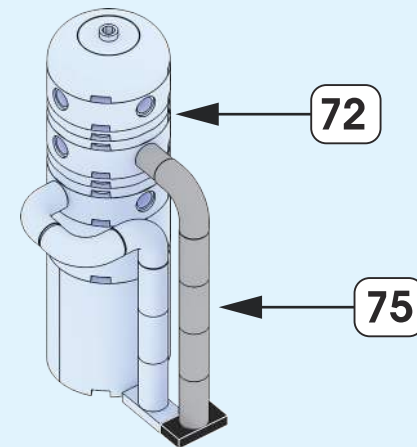

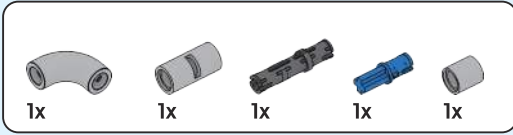

77

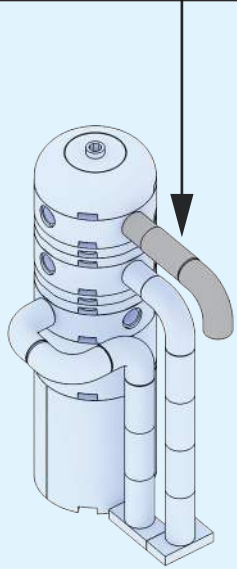
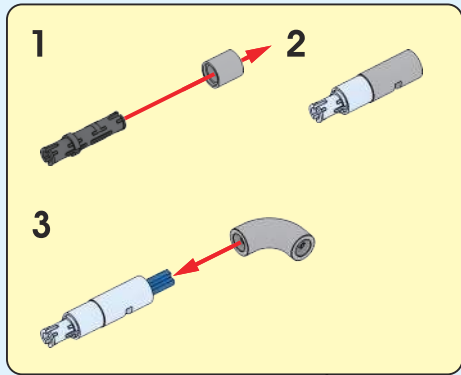

78

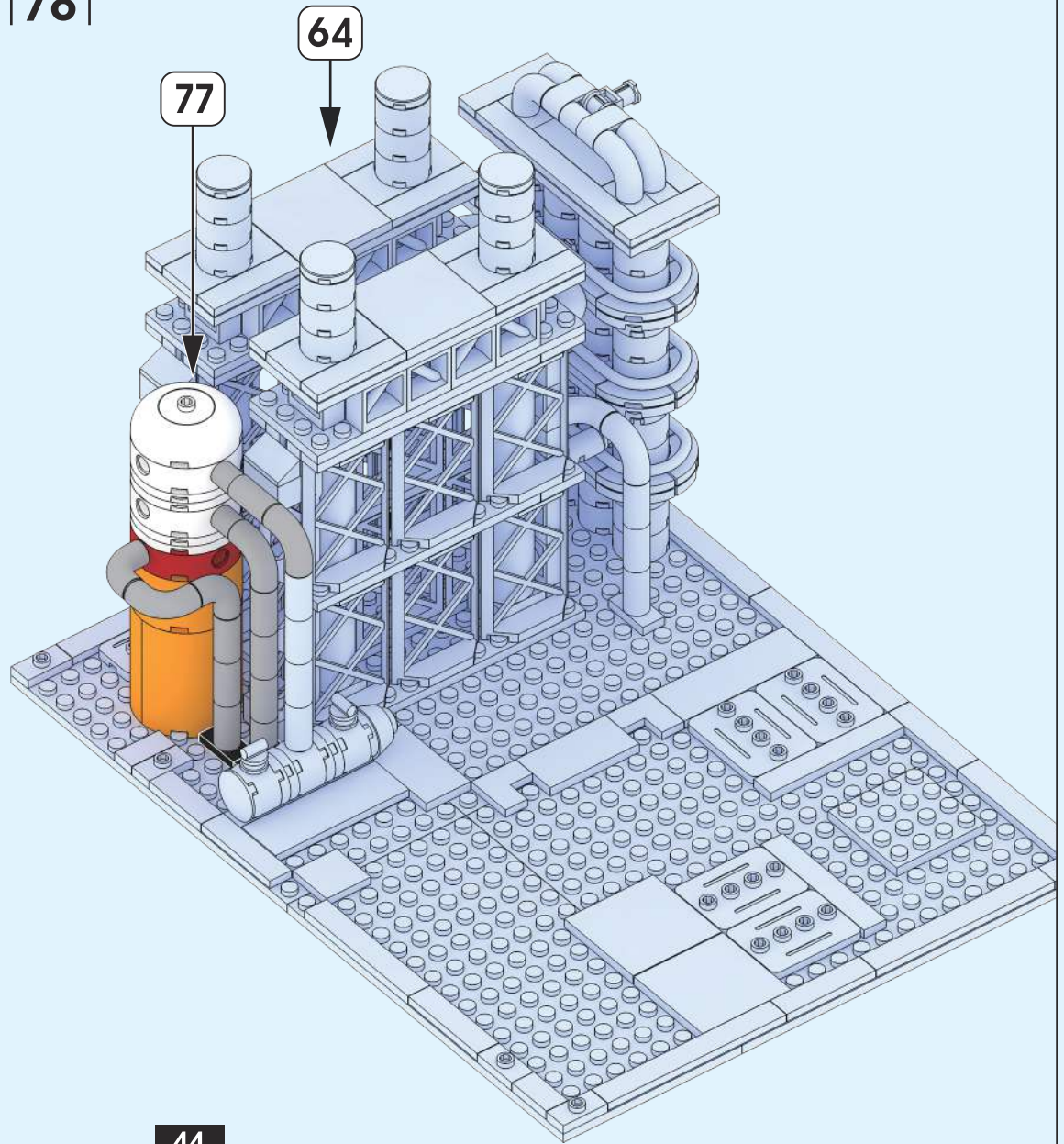

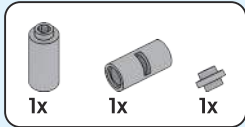
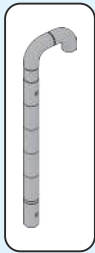

| 79 |

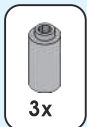

| 80 |

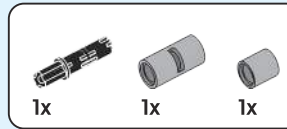

| 81 |

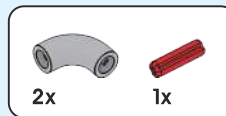

| 82 |

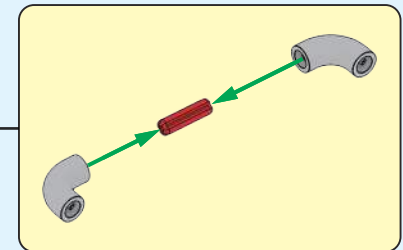
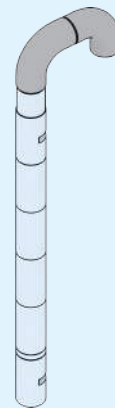

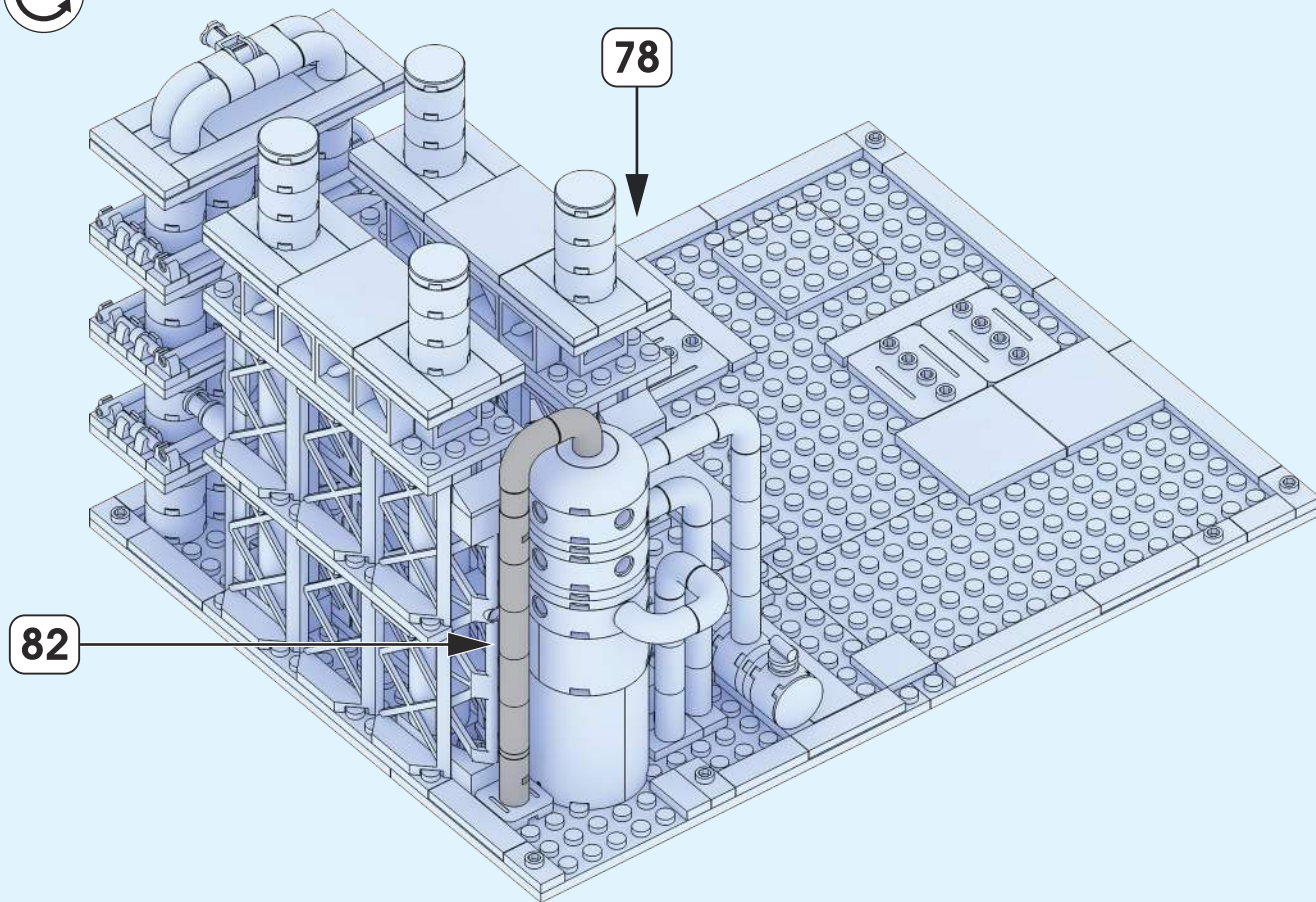

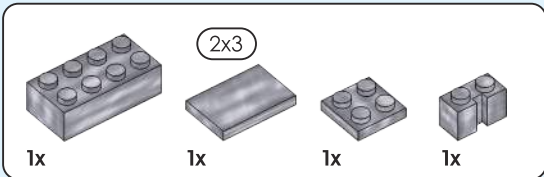
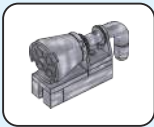

84

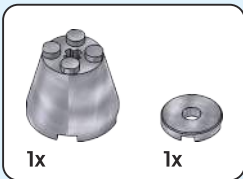
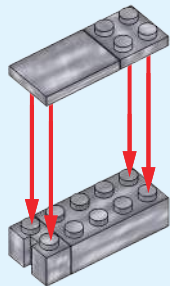

85

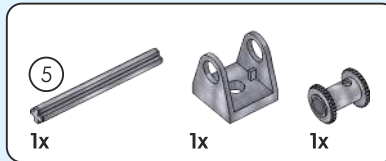
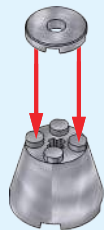

86

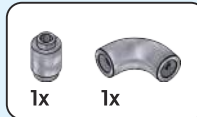
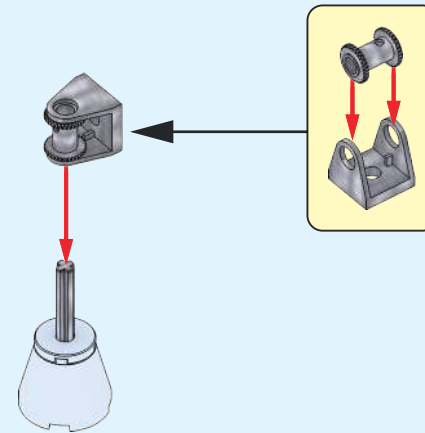

87

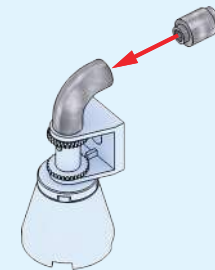

| 88 |



87

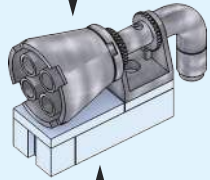

84

| 89 |



88

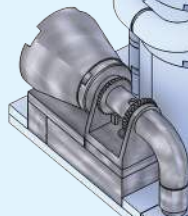

83

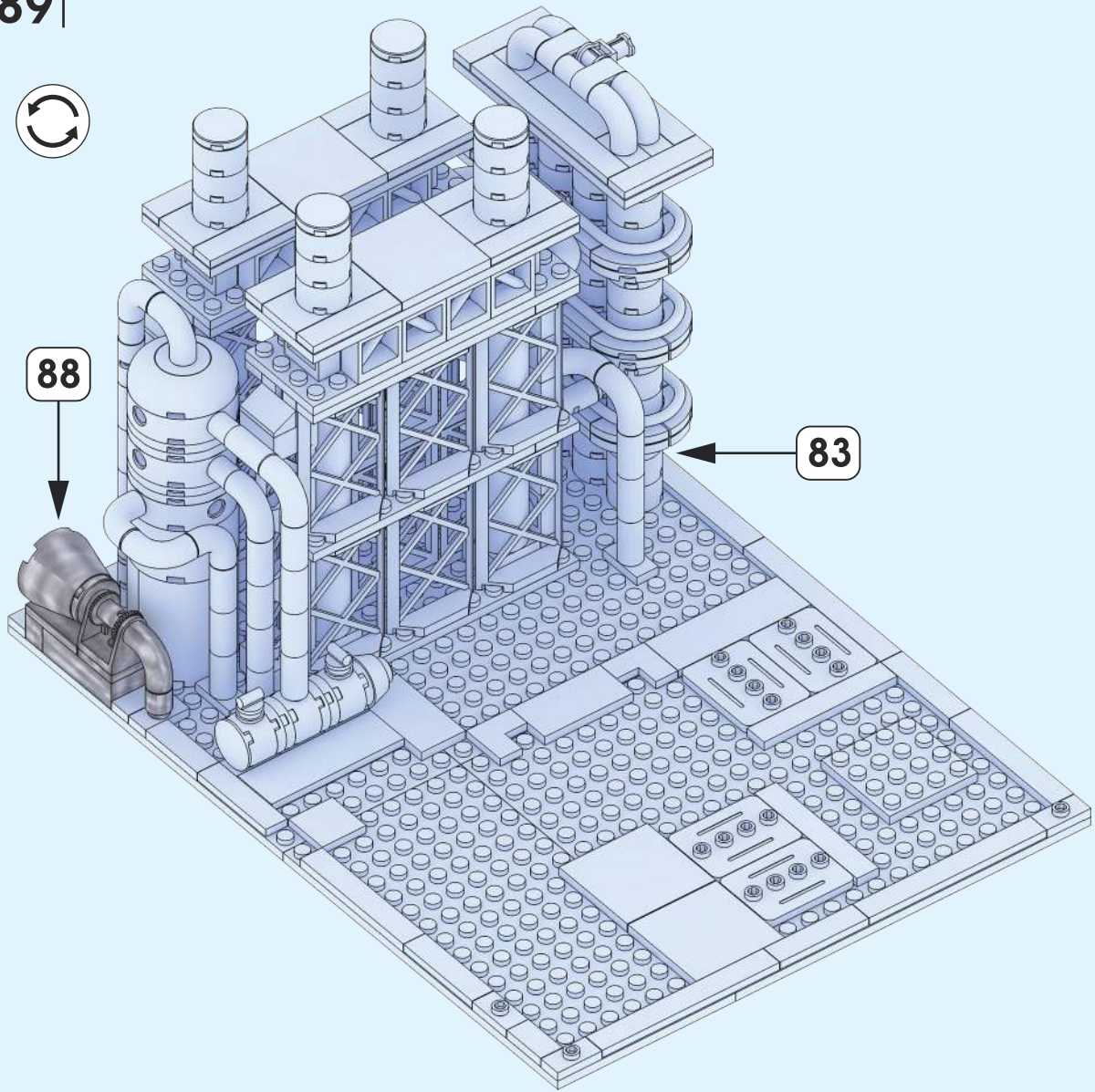

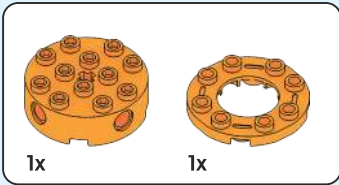
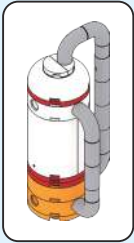

| 90 |

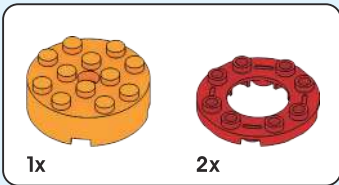
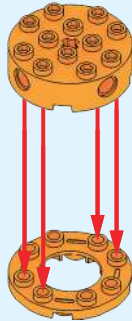

| 91 |

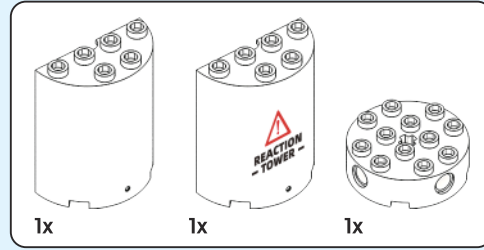
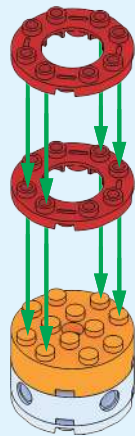

| 92 |

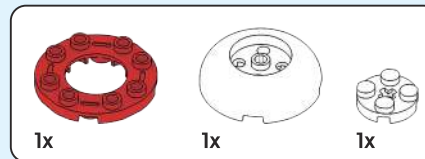
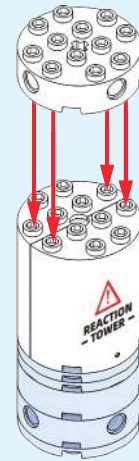

| 93 |

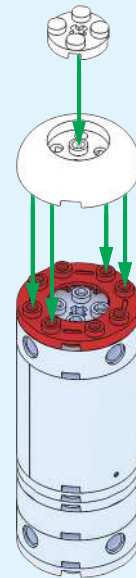

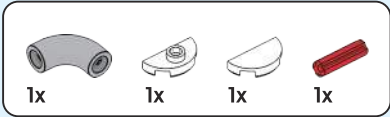

| 94 |

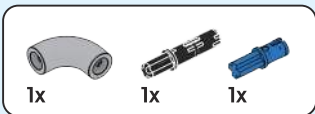
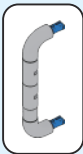
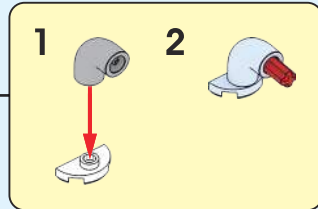

| 95 |

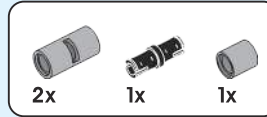
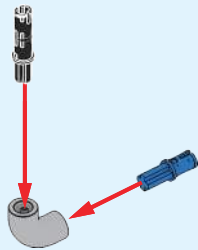

| 96 |

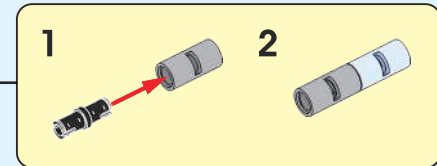
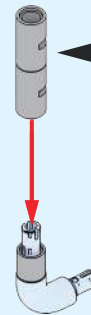

| 97 |

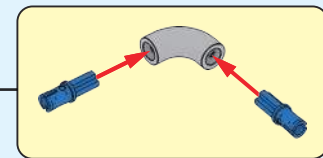

| 98 |

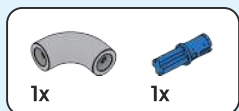
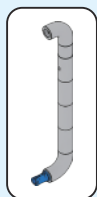
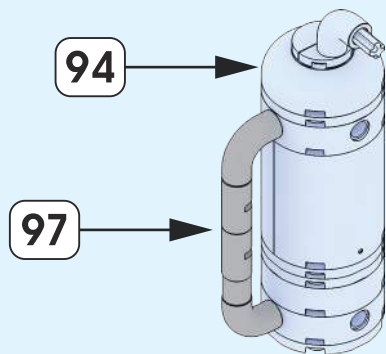

| 99 |

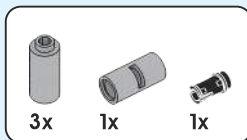
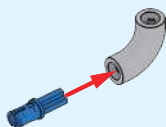

| 100 |

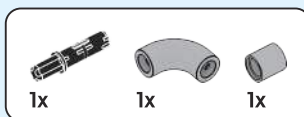
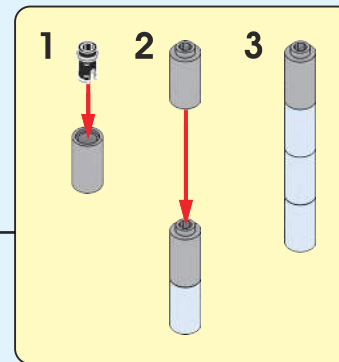

| 101 |

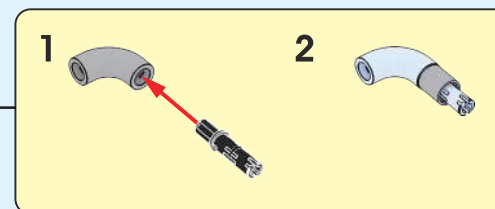

| 102 |

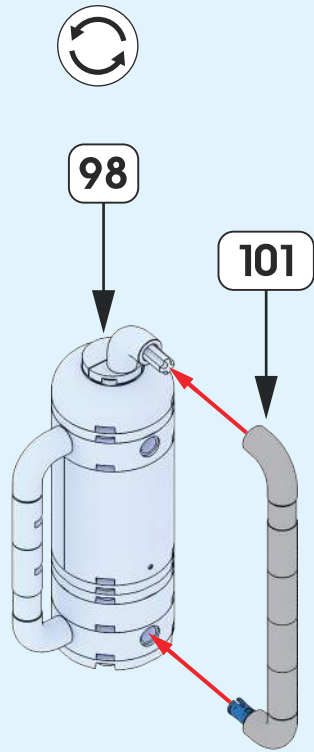

| 103 |

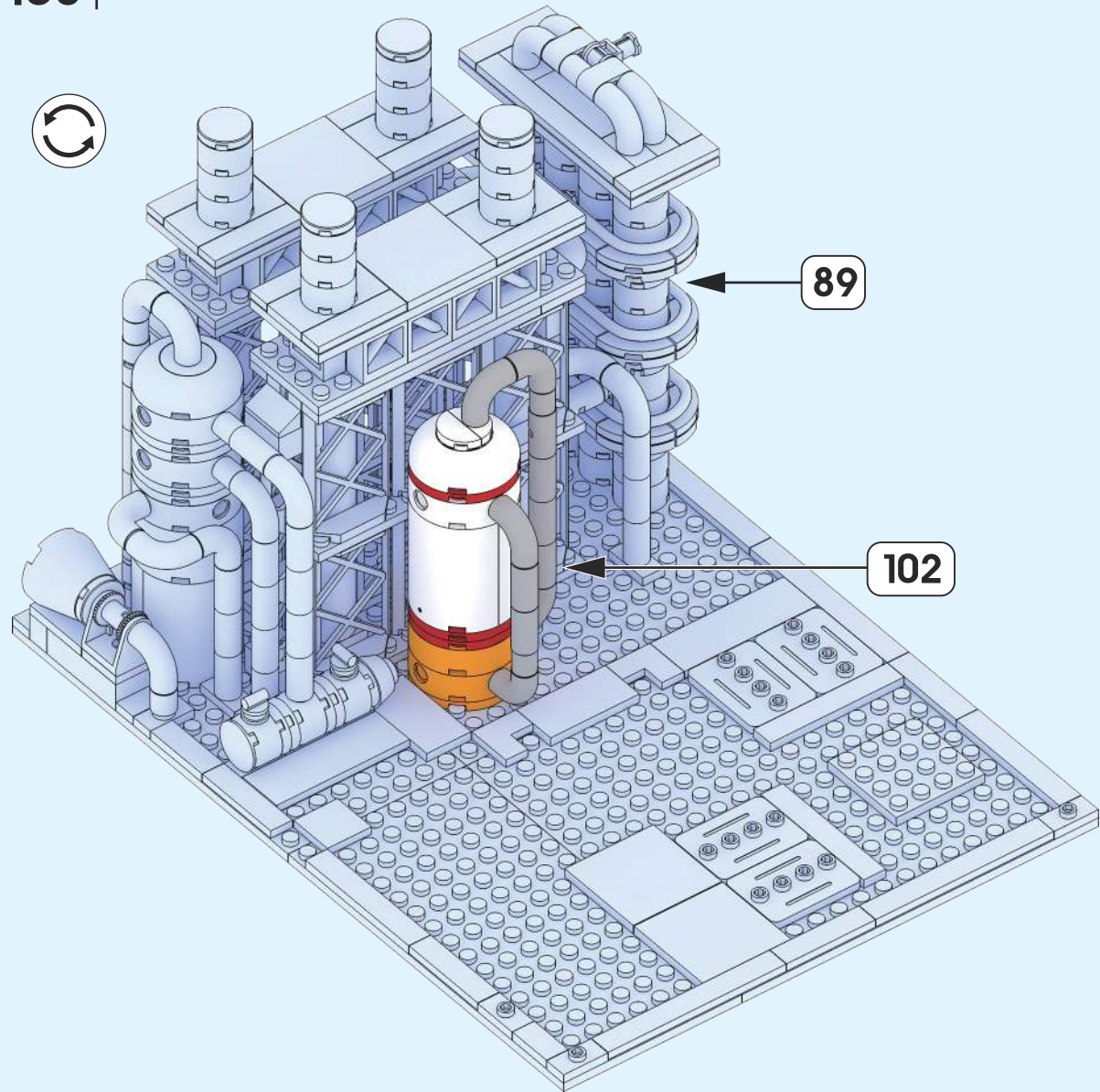

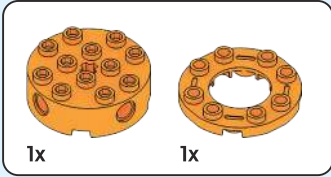
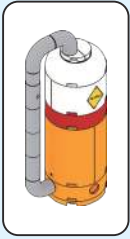

| 104 |

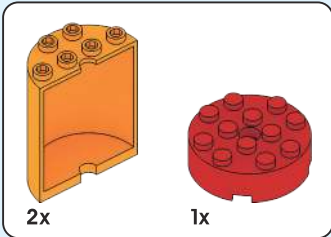
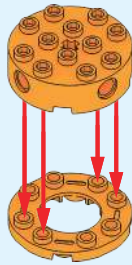

| 105 |

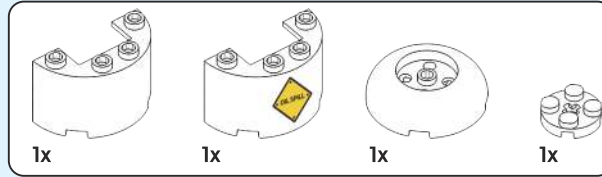
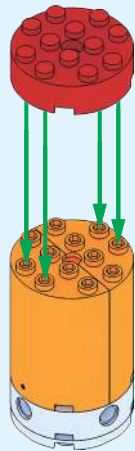

| 106 |

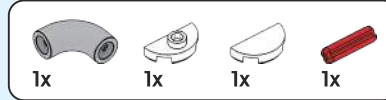
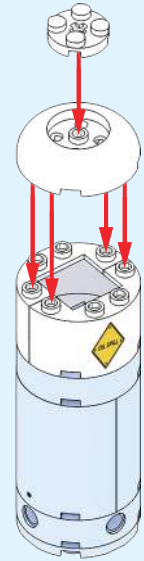

| 107 |

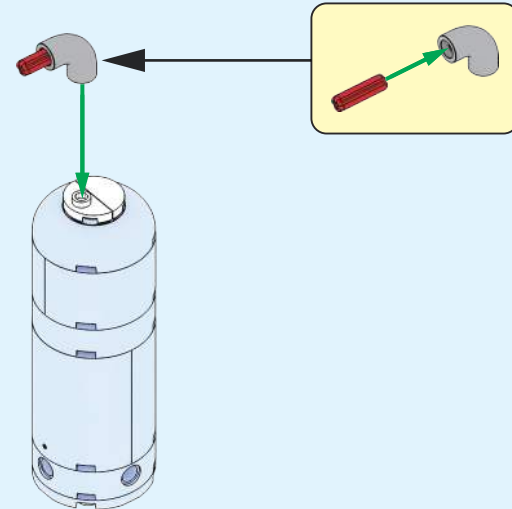

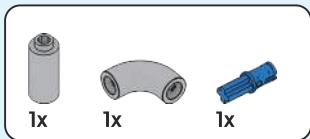
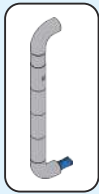

| 108 |

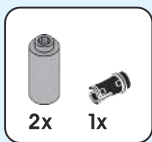
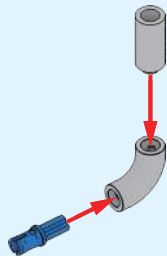

| 109 |

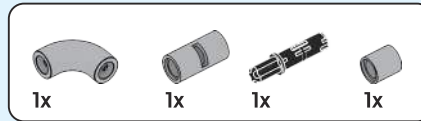
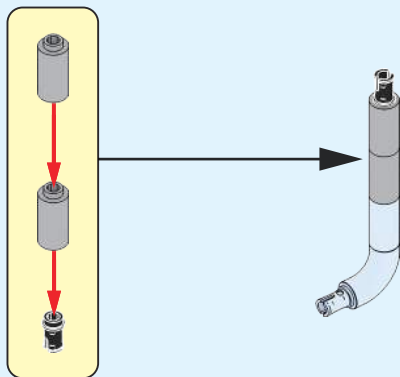

| 110 |

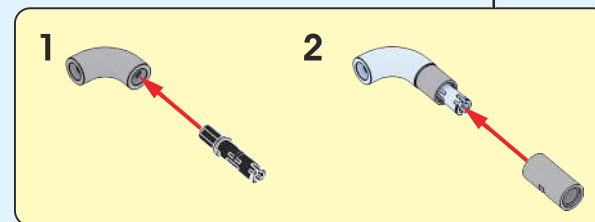

| 111 |



110

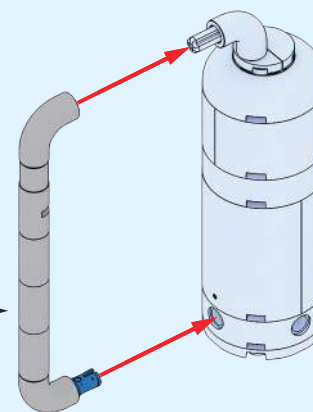

107

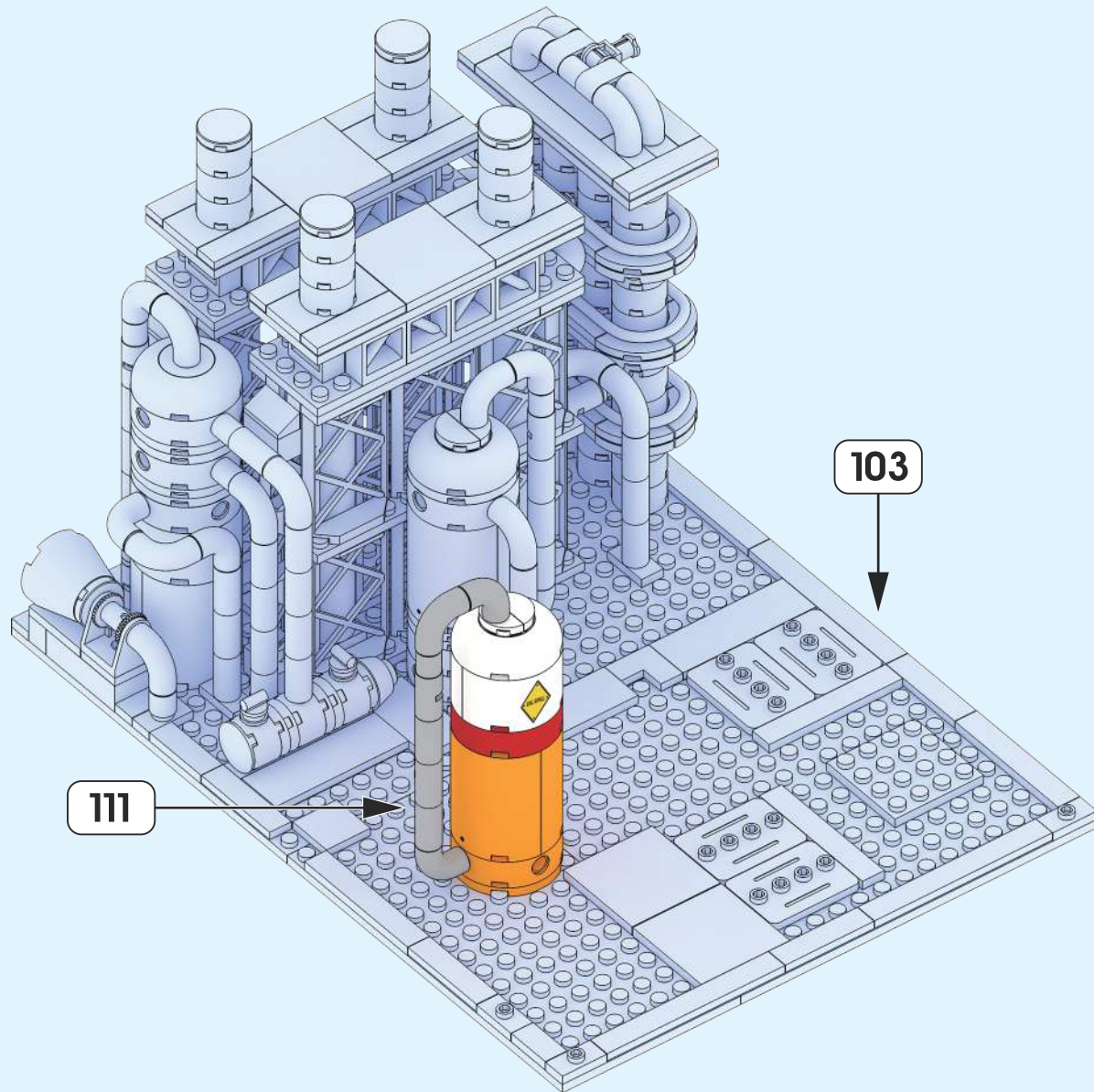

111

103

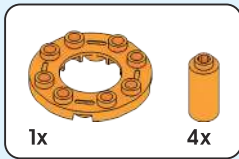

113

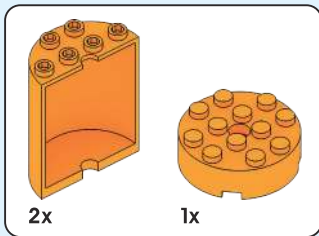
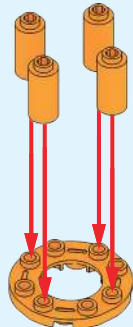

114

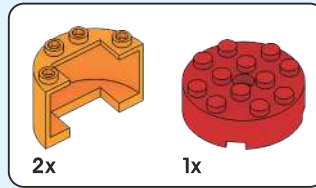
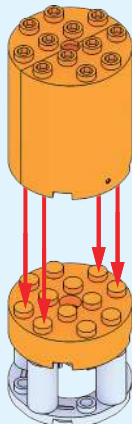

115

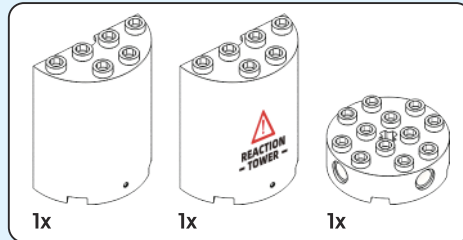
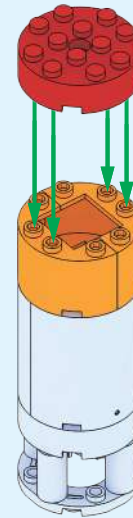

116



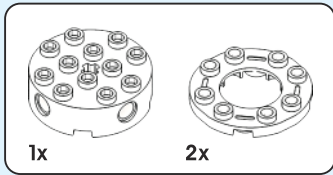

| 117 |

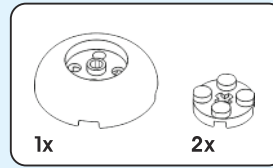
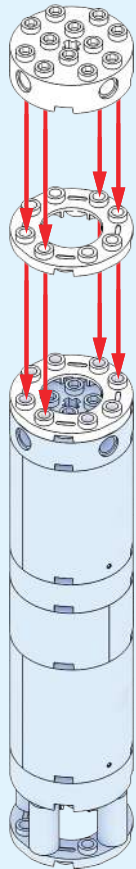

| 118 |



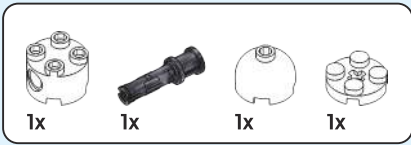

| 119 |

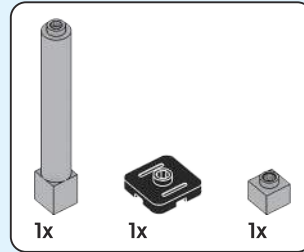
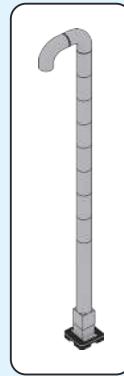
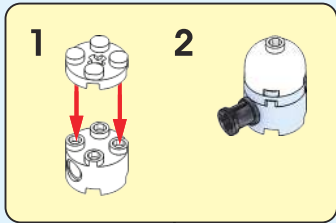

| 120 |

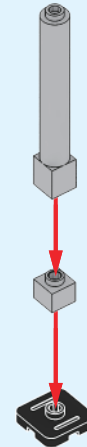



| 121 |

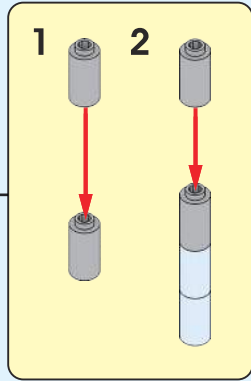
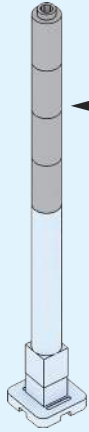

| 122 |

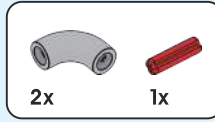
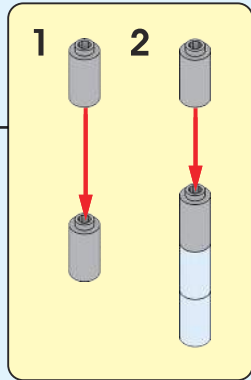
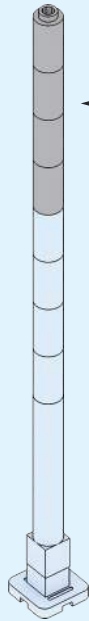

| 123 |

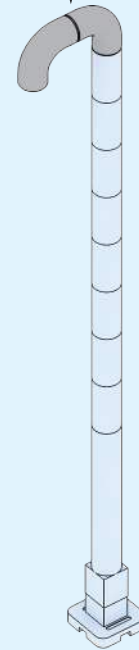
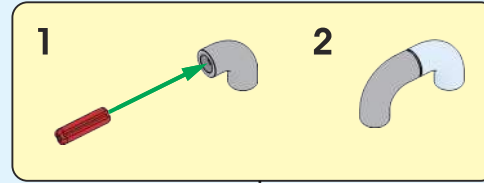

| 124 |

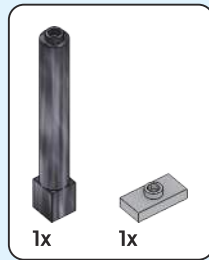
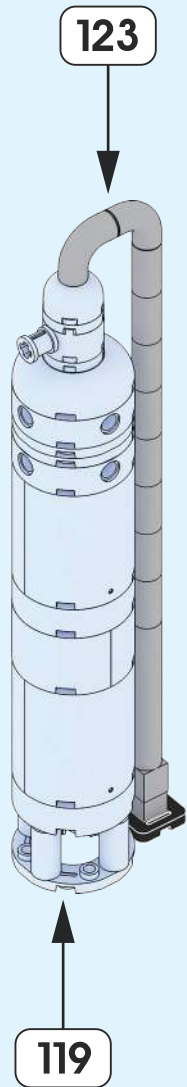

| 125 |



| 126 |





3x

| 127 |



2x

1x

| 128 |

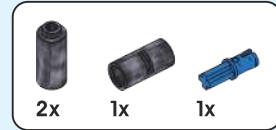
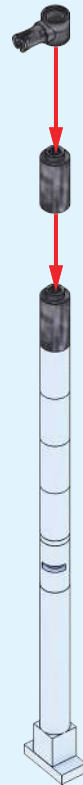

2x

1x

1x

| 129 |

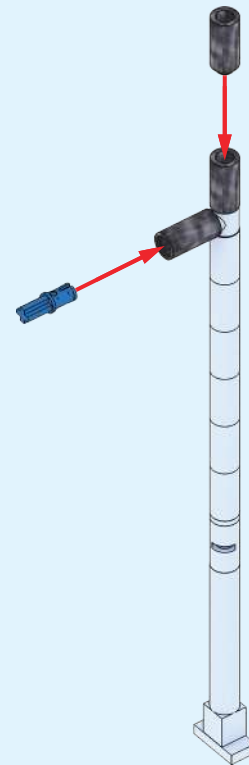

| 130 |

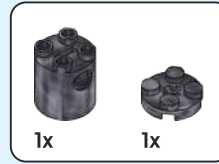

| 131 |



| 132 |





| 133 |

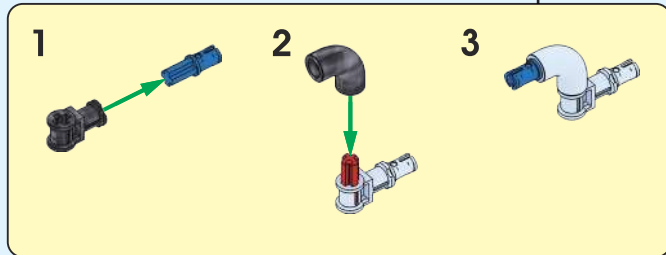

| 134 |

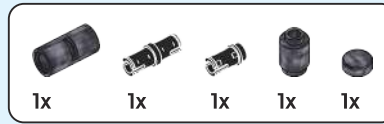
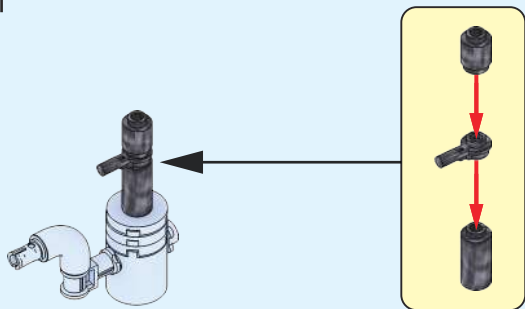

| 135 |

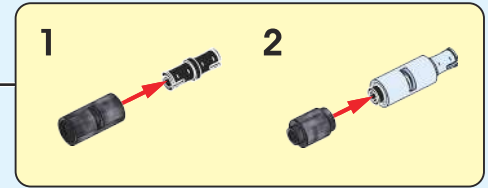
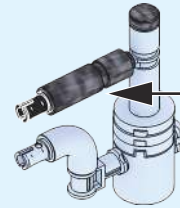

| 136 |

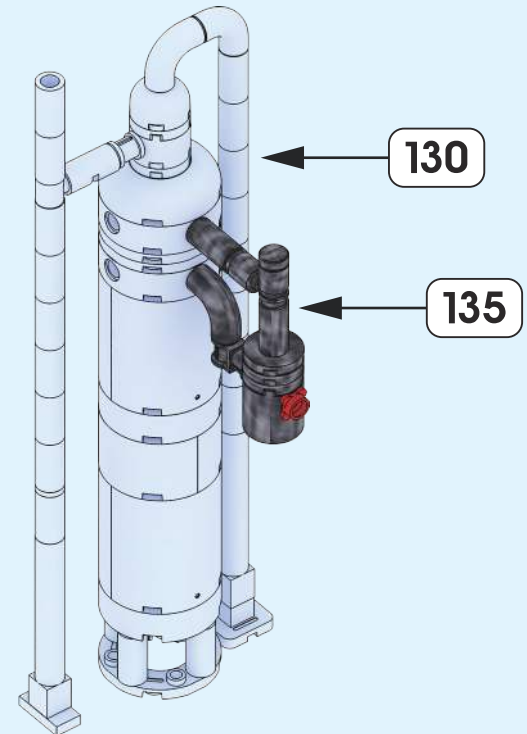

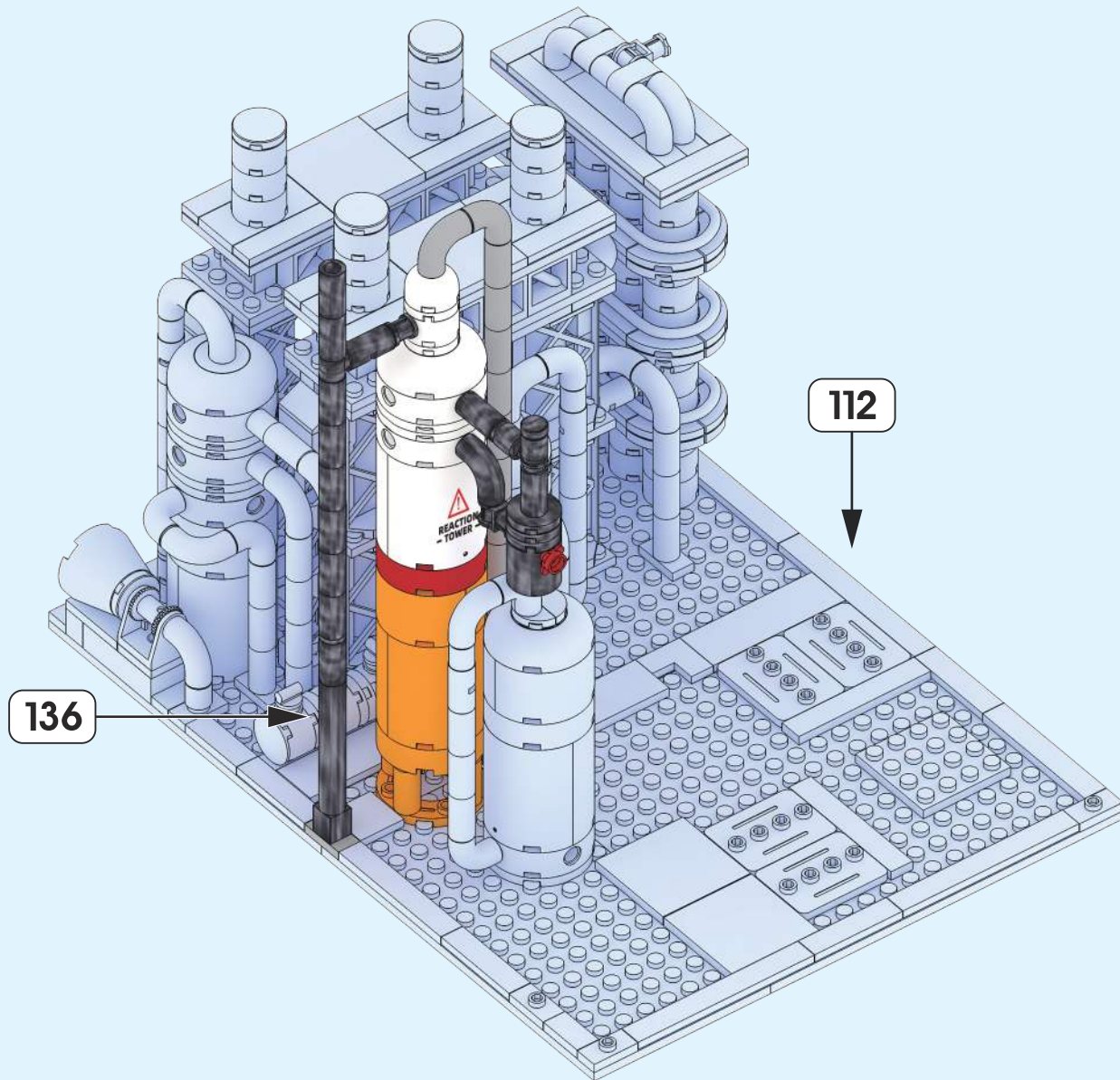

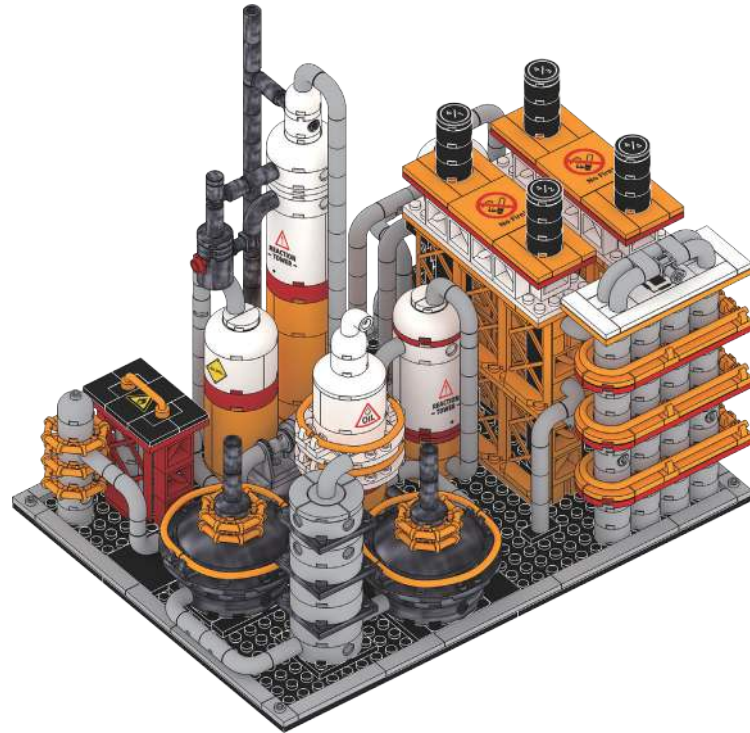

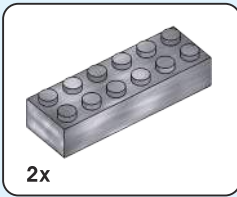
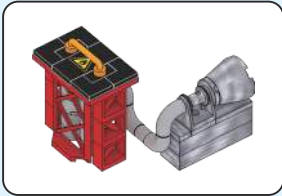

2x

| 138 |

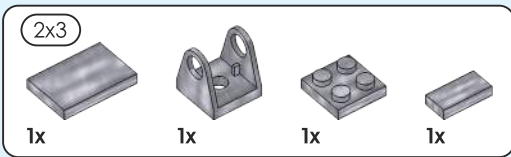
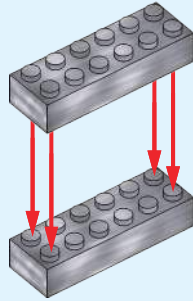

| 139 |

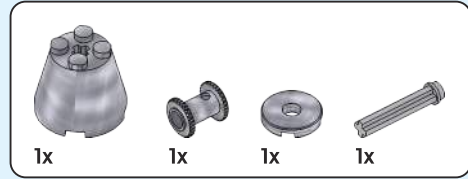
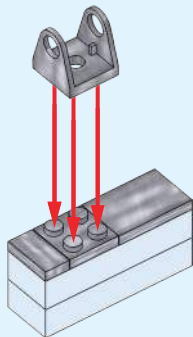

| 140 |

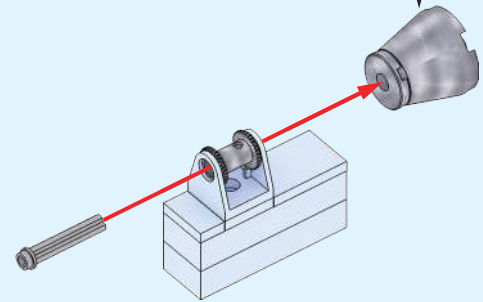
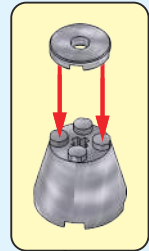

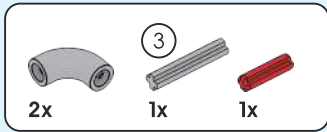

| 141 |

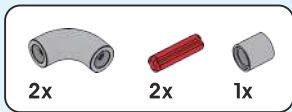
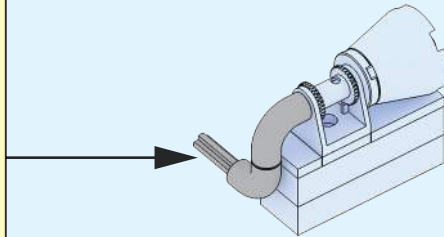
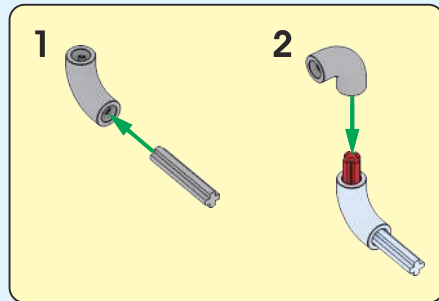

| 142 |

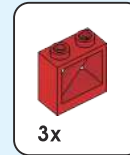
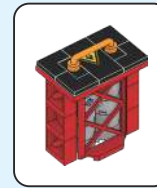
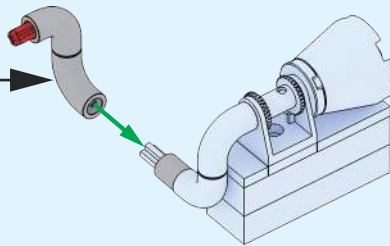
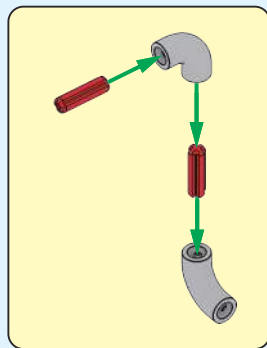

| 143 |



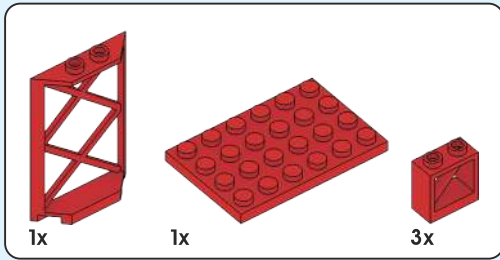

| 144 |

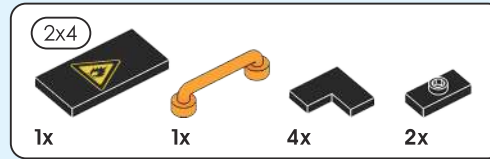
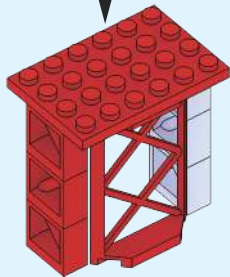
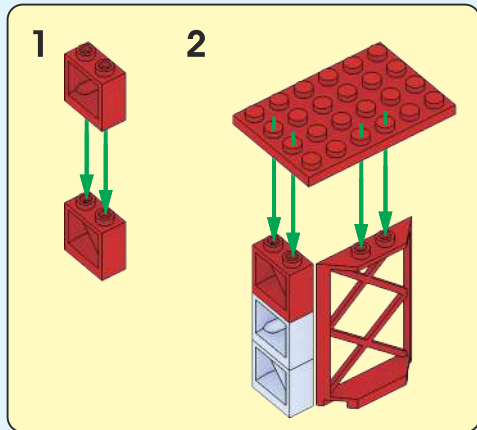

| 145 |

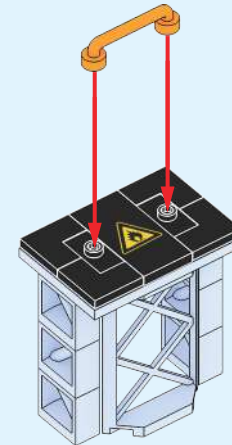

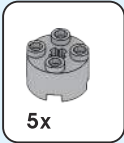

146

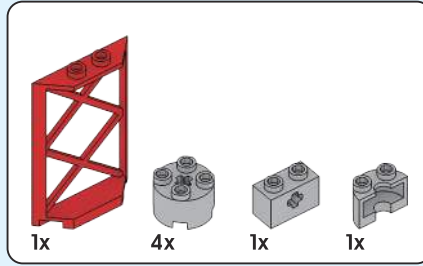
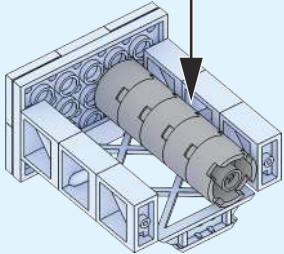
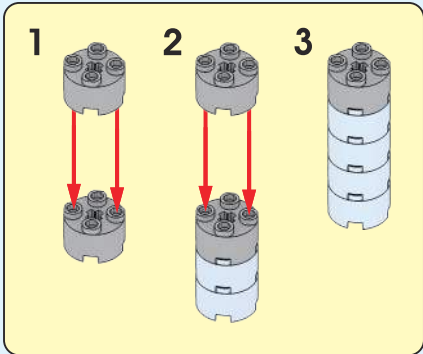

147

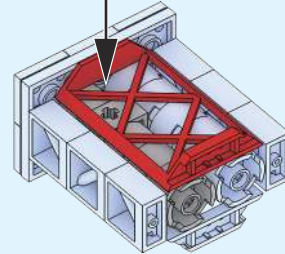
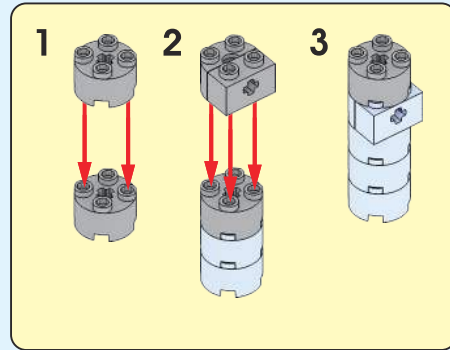

| 148 |



147

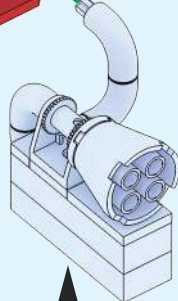
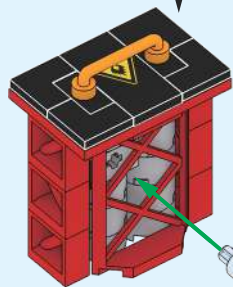

142

| 149 |



148



137

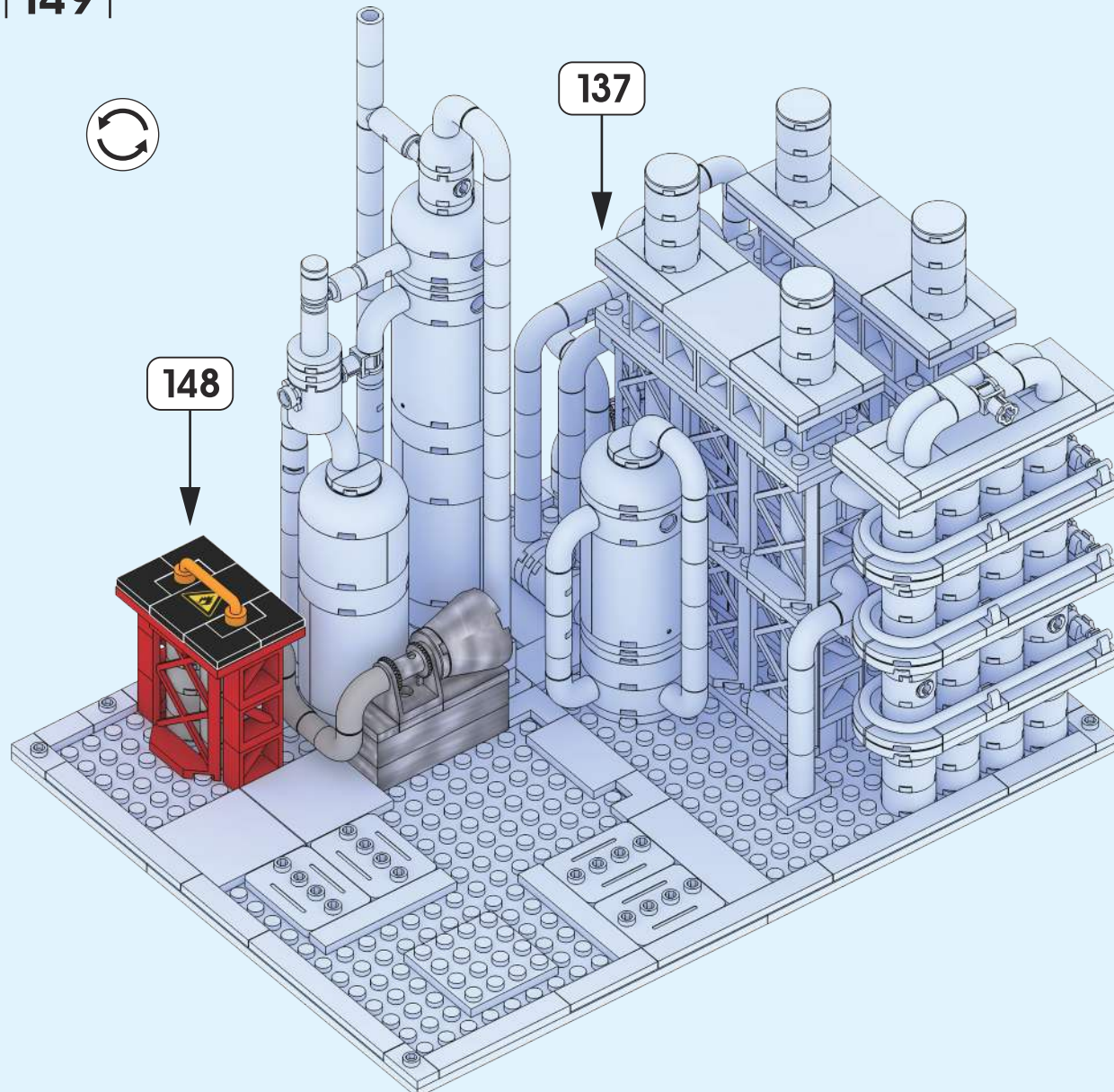

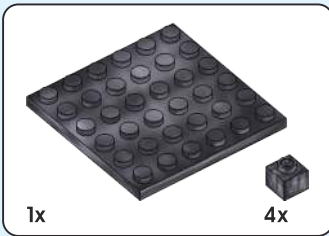
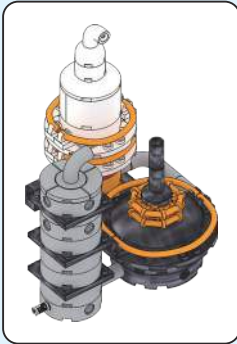

| 150 |

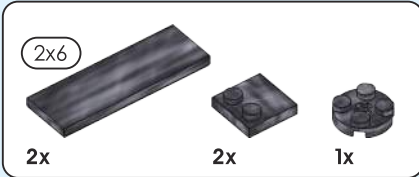
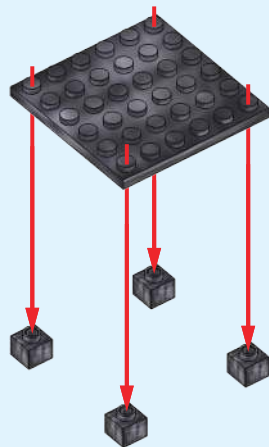

| 151 |

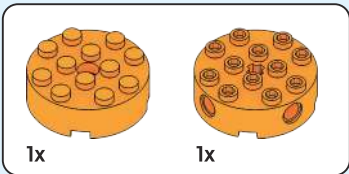
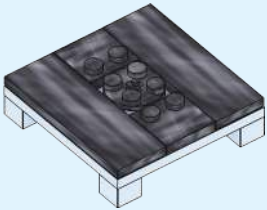

| 152 |

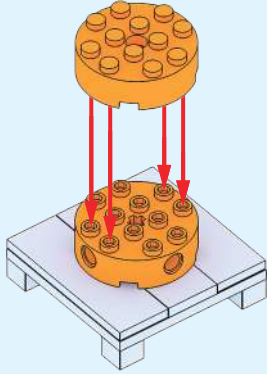

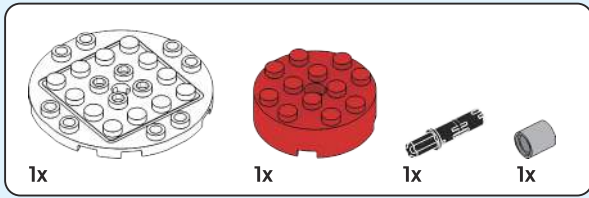

153

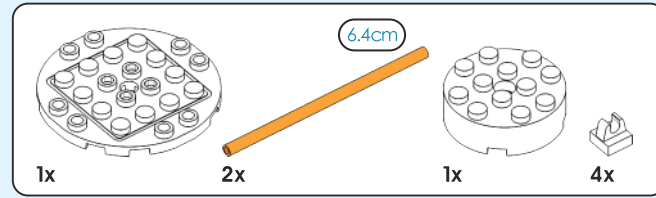
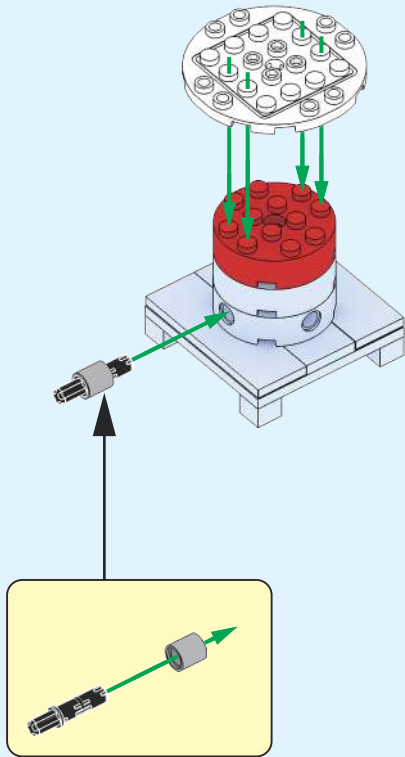

154

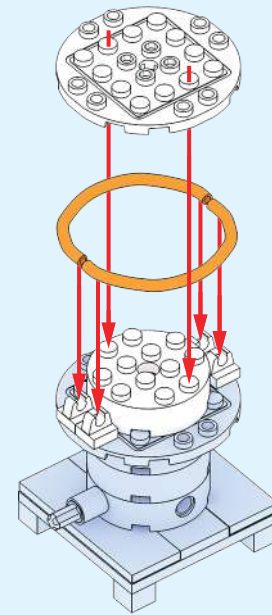

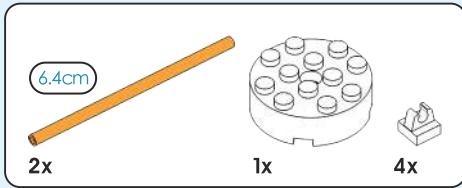

| 155 |

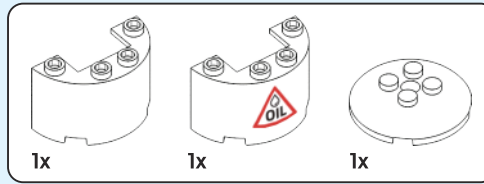
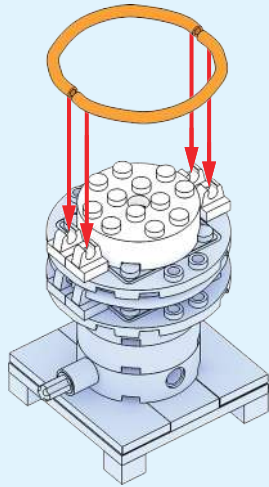

| 156 |

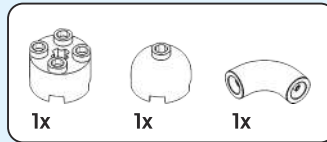
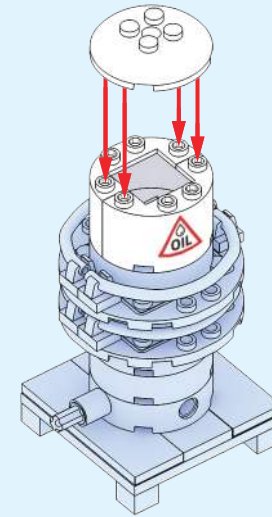

| 157 |

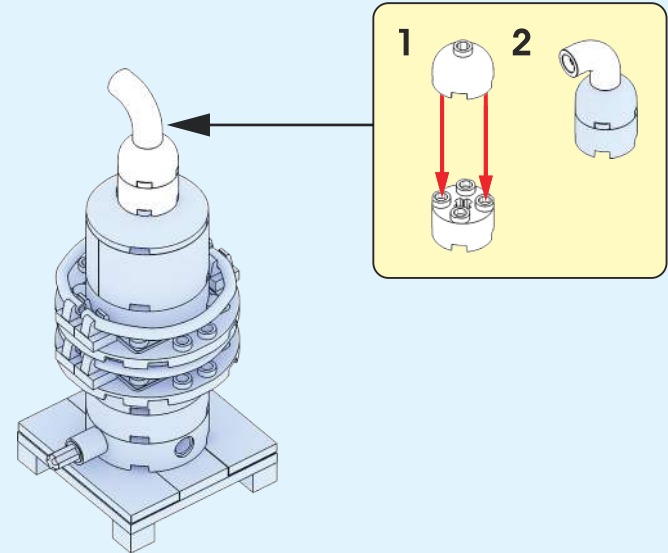

6.4cm

1:1

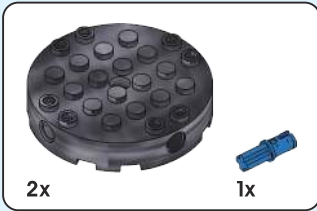

| 158 |

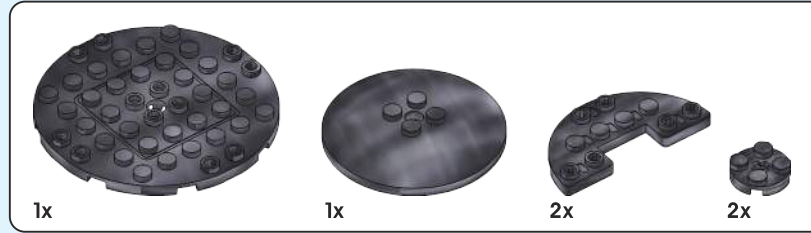
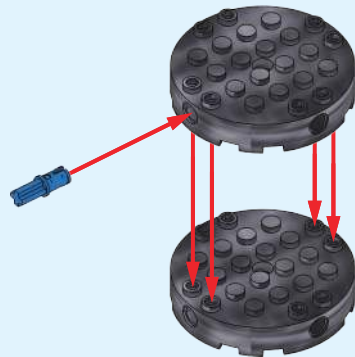

| 159 |

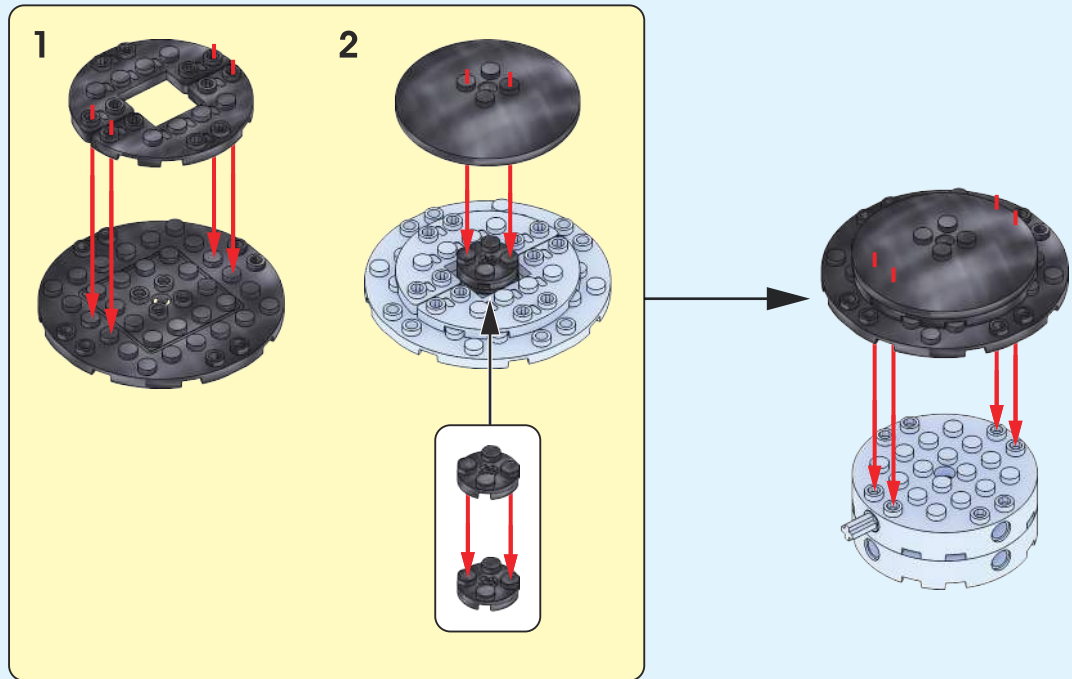

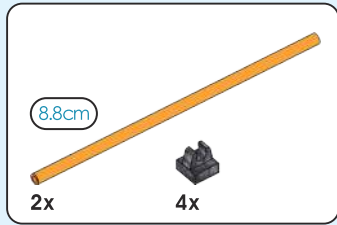

| 160 |

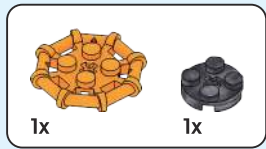
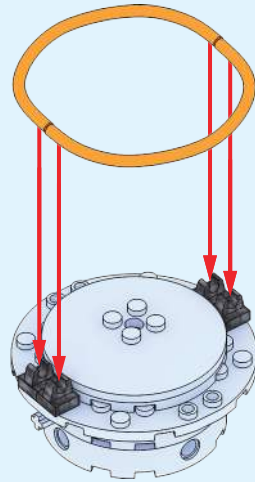

| 161 |

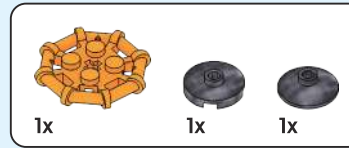
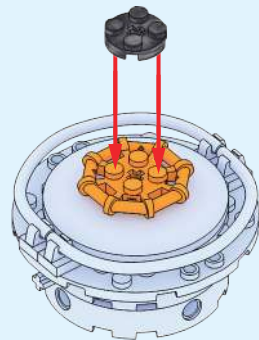

| 162 |

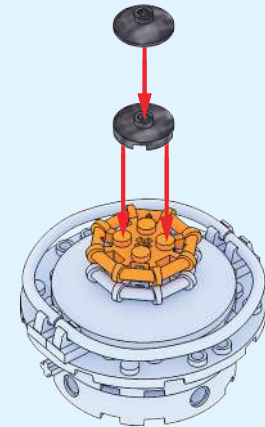

| 163 |

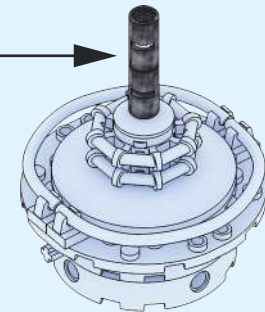
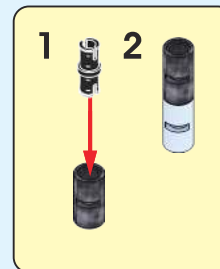

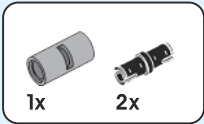
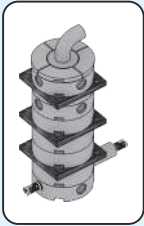

| 164 |

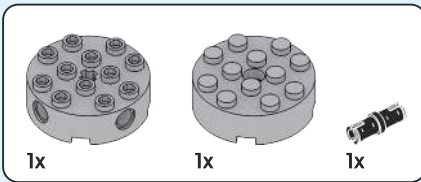
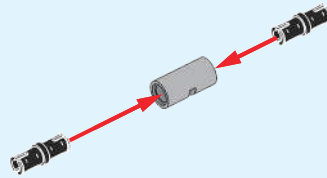

| 165 |

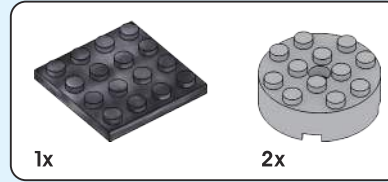
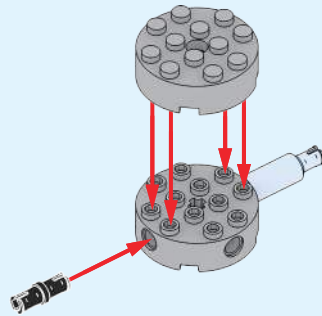

| 166 |

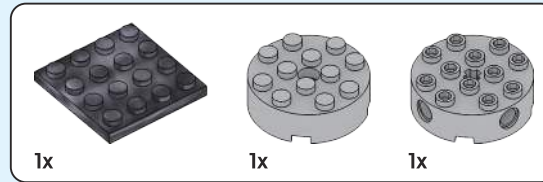
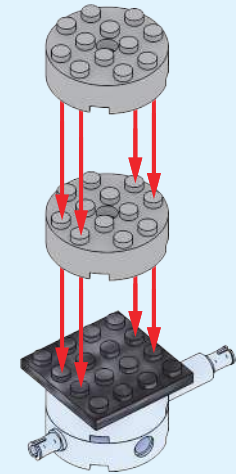

| 167 |

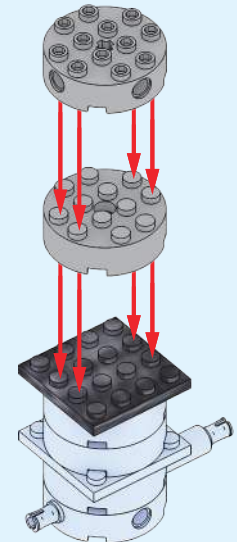

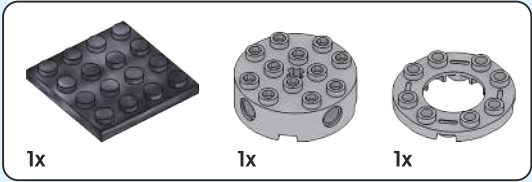

| 168 |

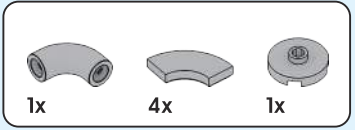
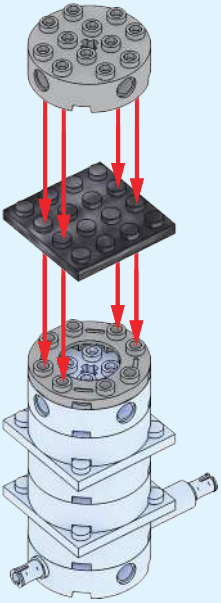

| 169 |

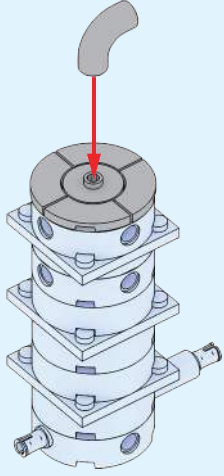

| 170 |

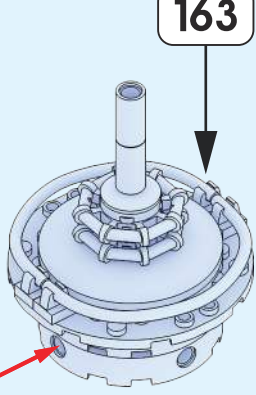
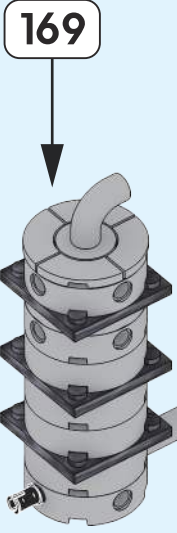

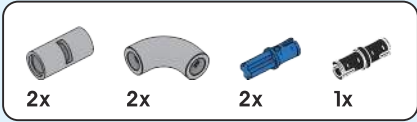

| 171 |

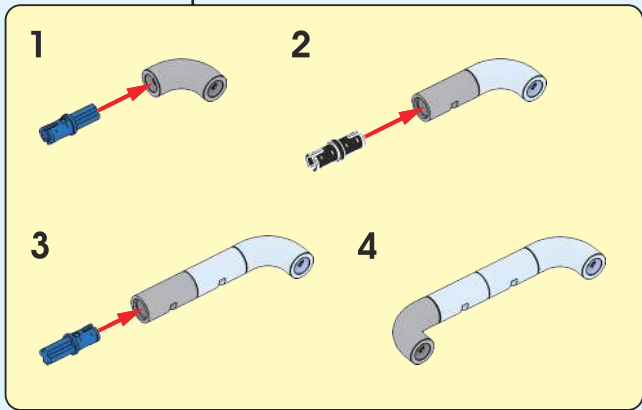
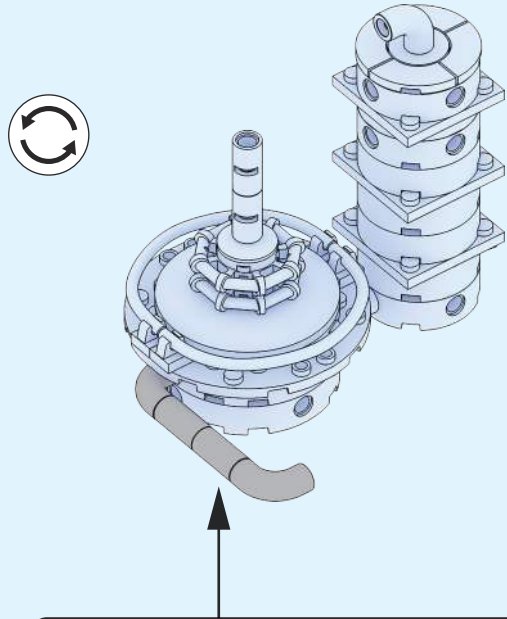

| 172 |

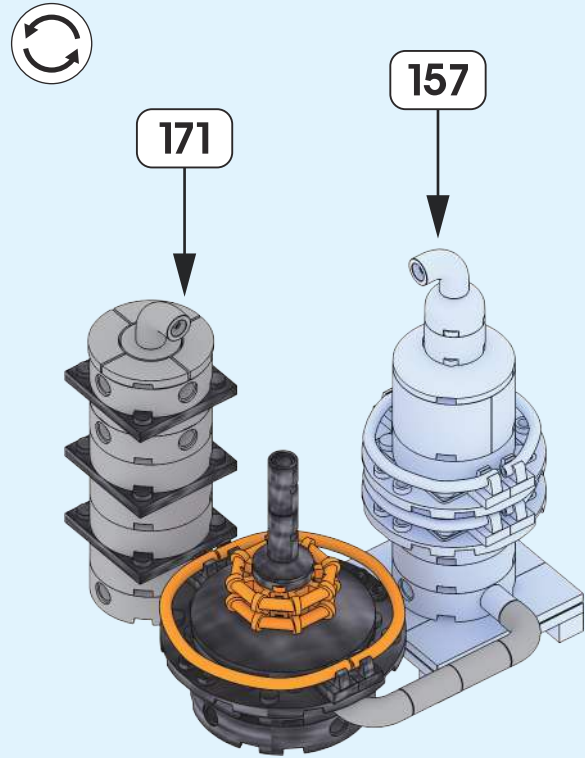



172

149

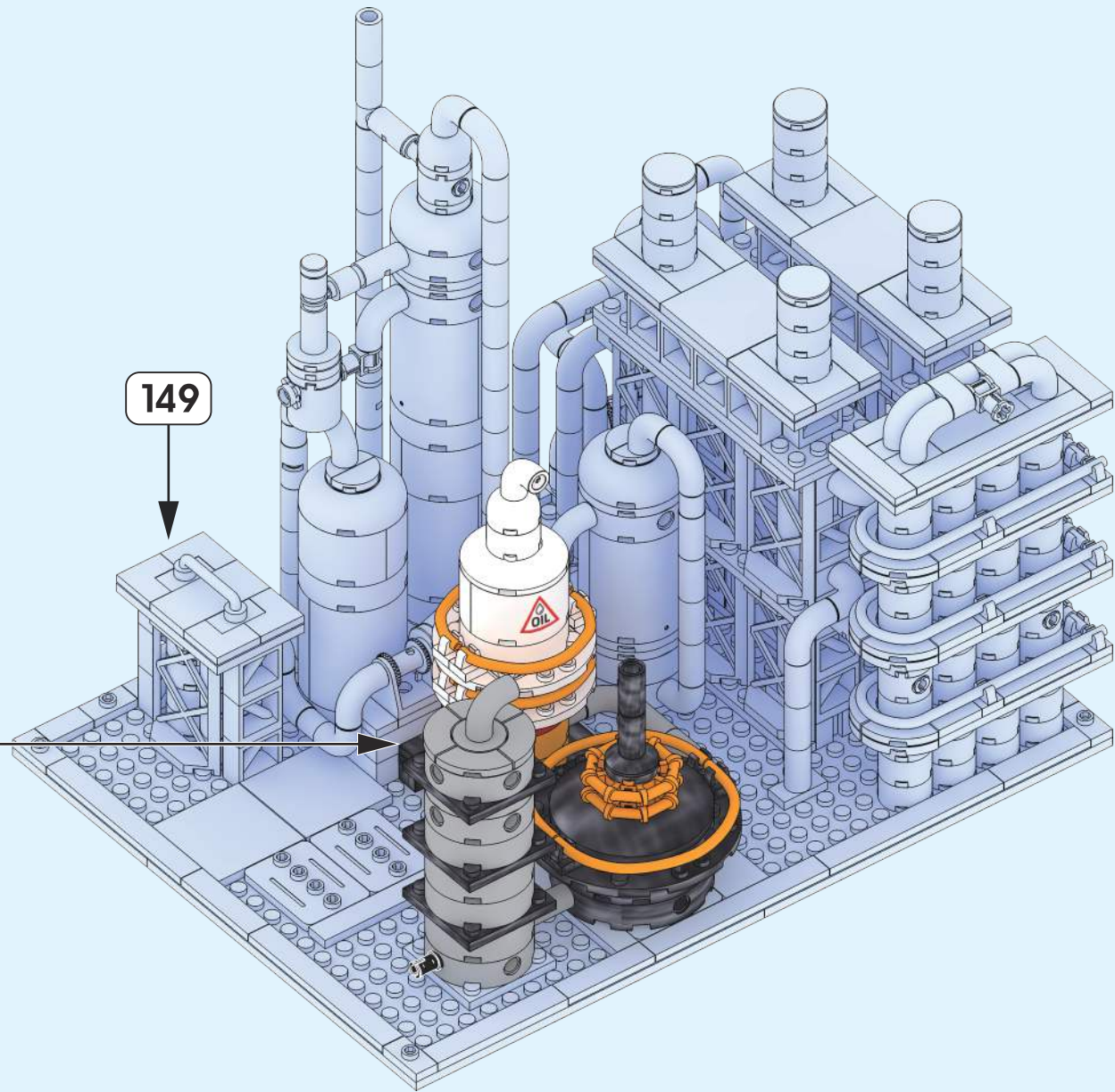



| 174 |

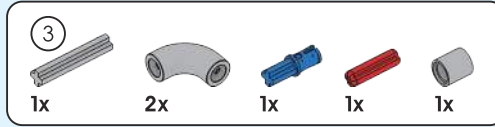

| 175 |

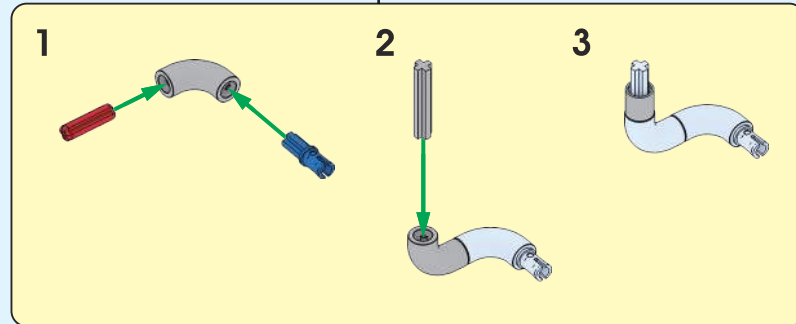
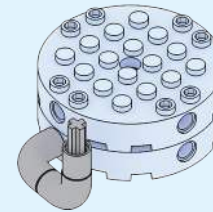



| 176 |

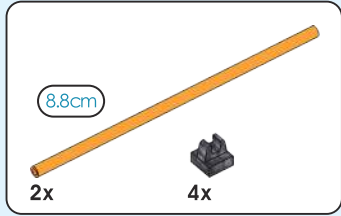
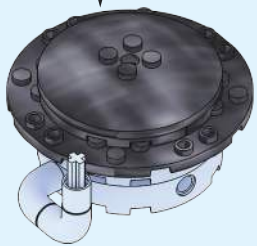
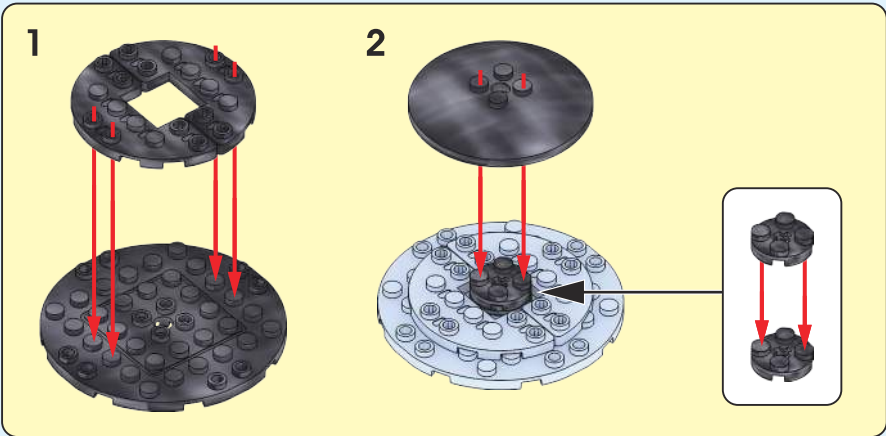

| 177 |

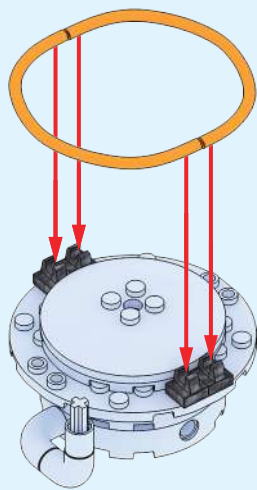

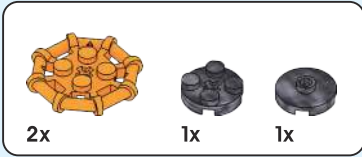

| 178 |

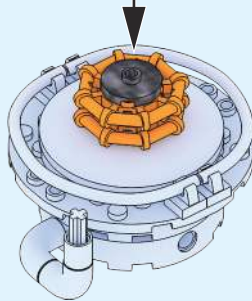
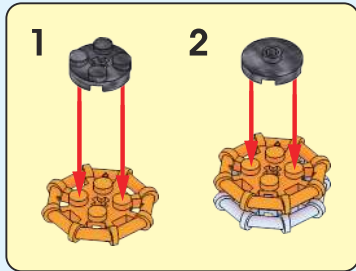

| 179 |

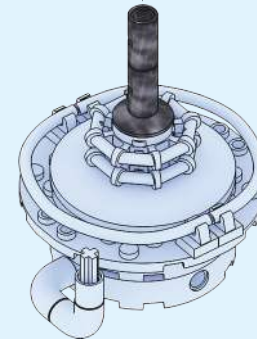
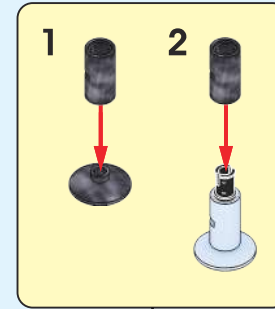



179

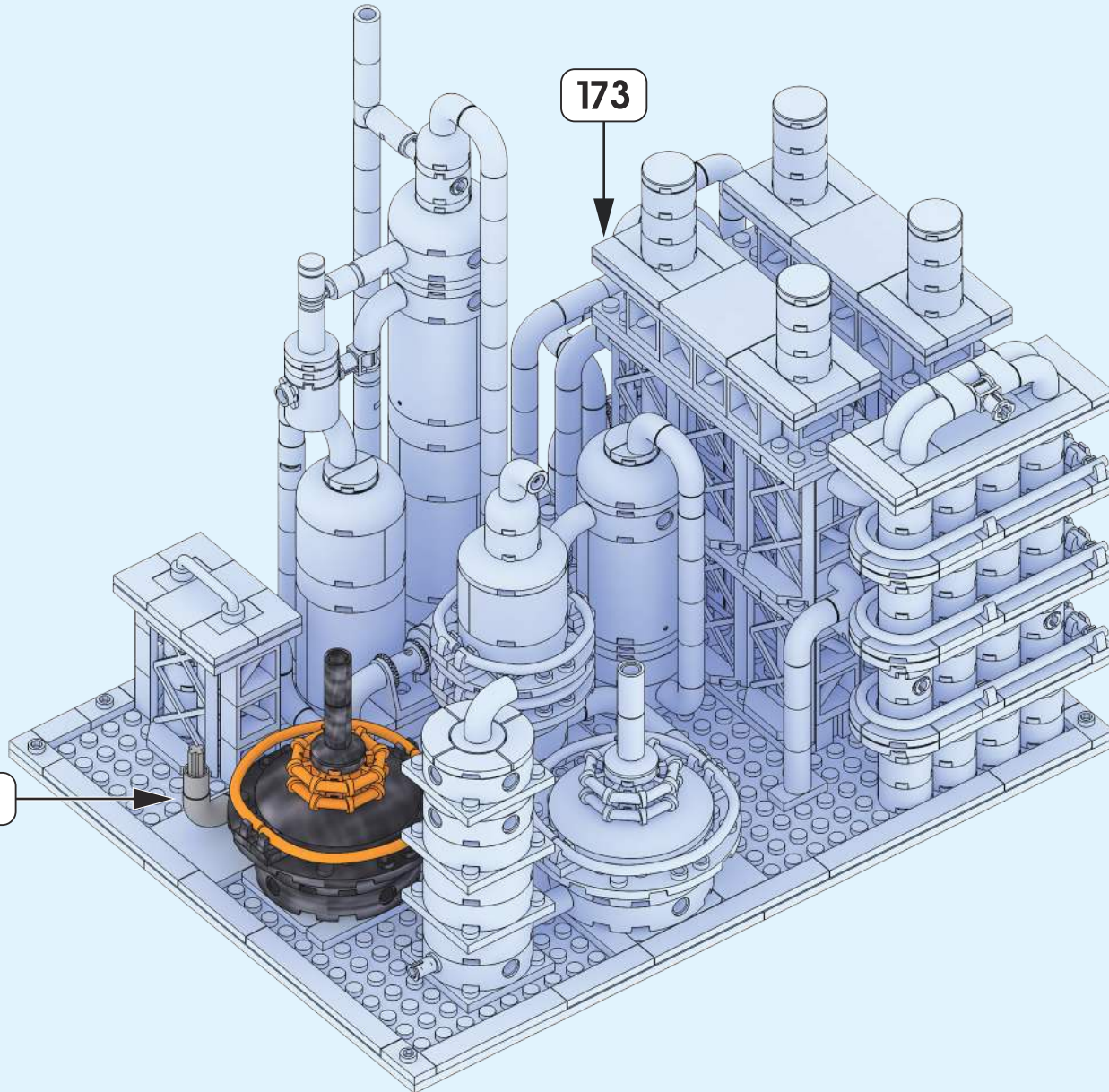

173

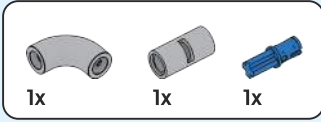

| 181 |

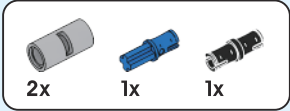
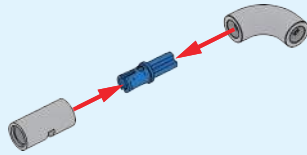

| 182 |

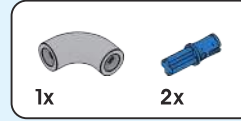
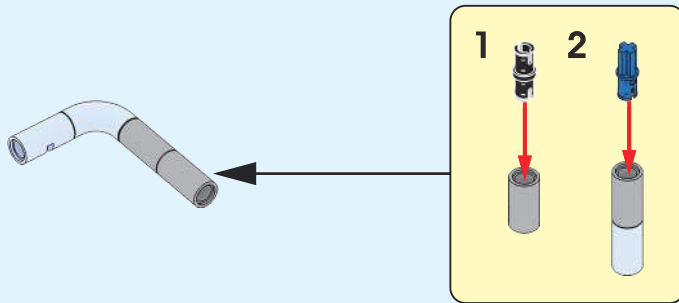

| 183 |

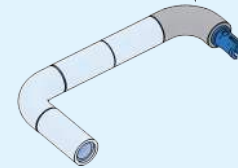
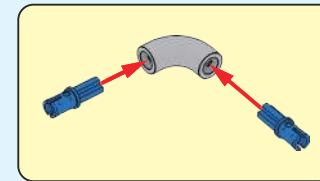

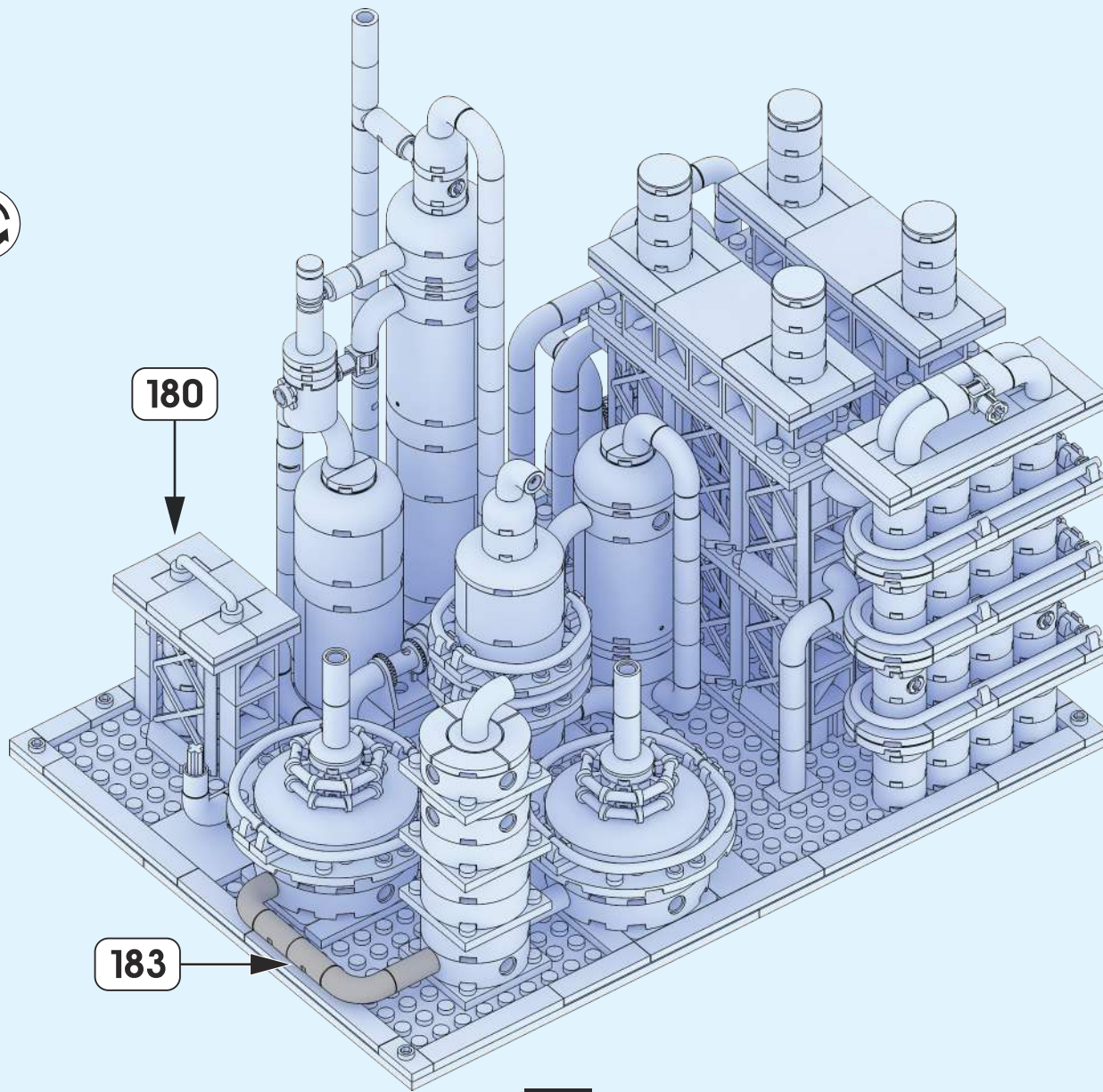

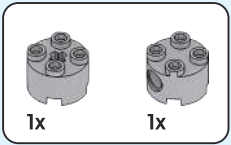
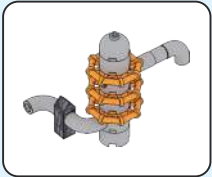

| 185 |

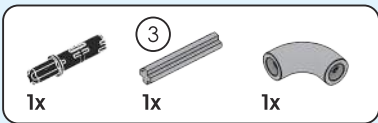
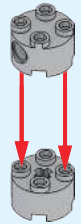

| 186 |

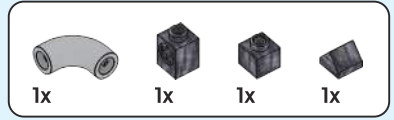
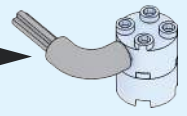
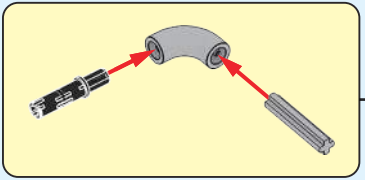

| 187 |

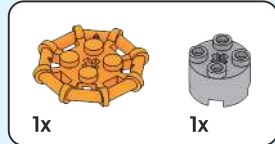
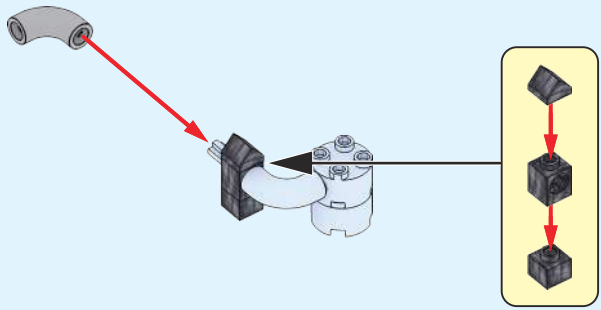

| 188 |

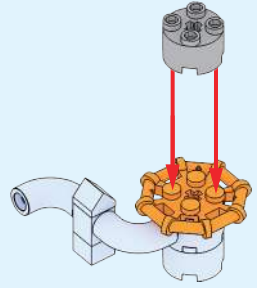

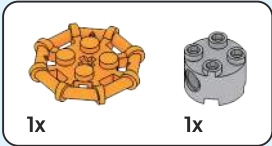

| 189 |

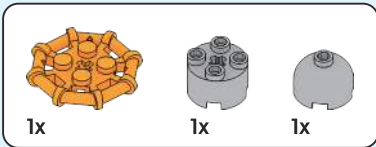
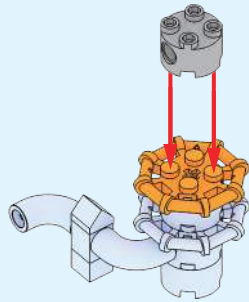

| 190 |

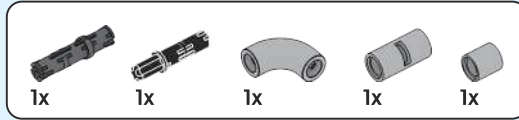
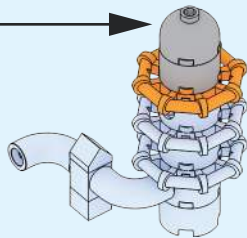
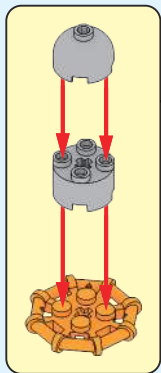

| 191 |

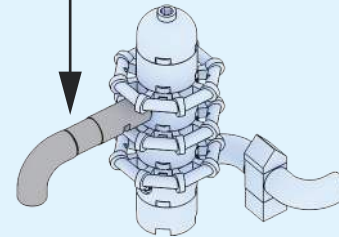
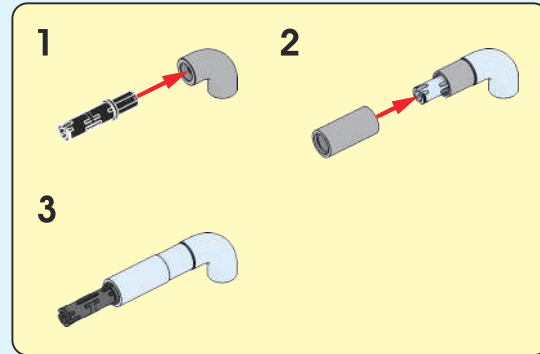

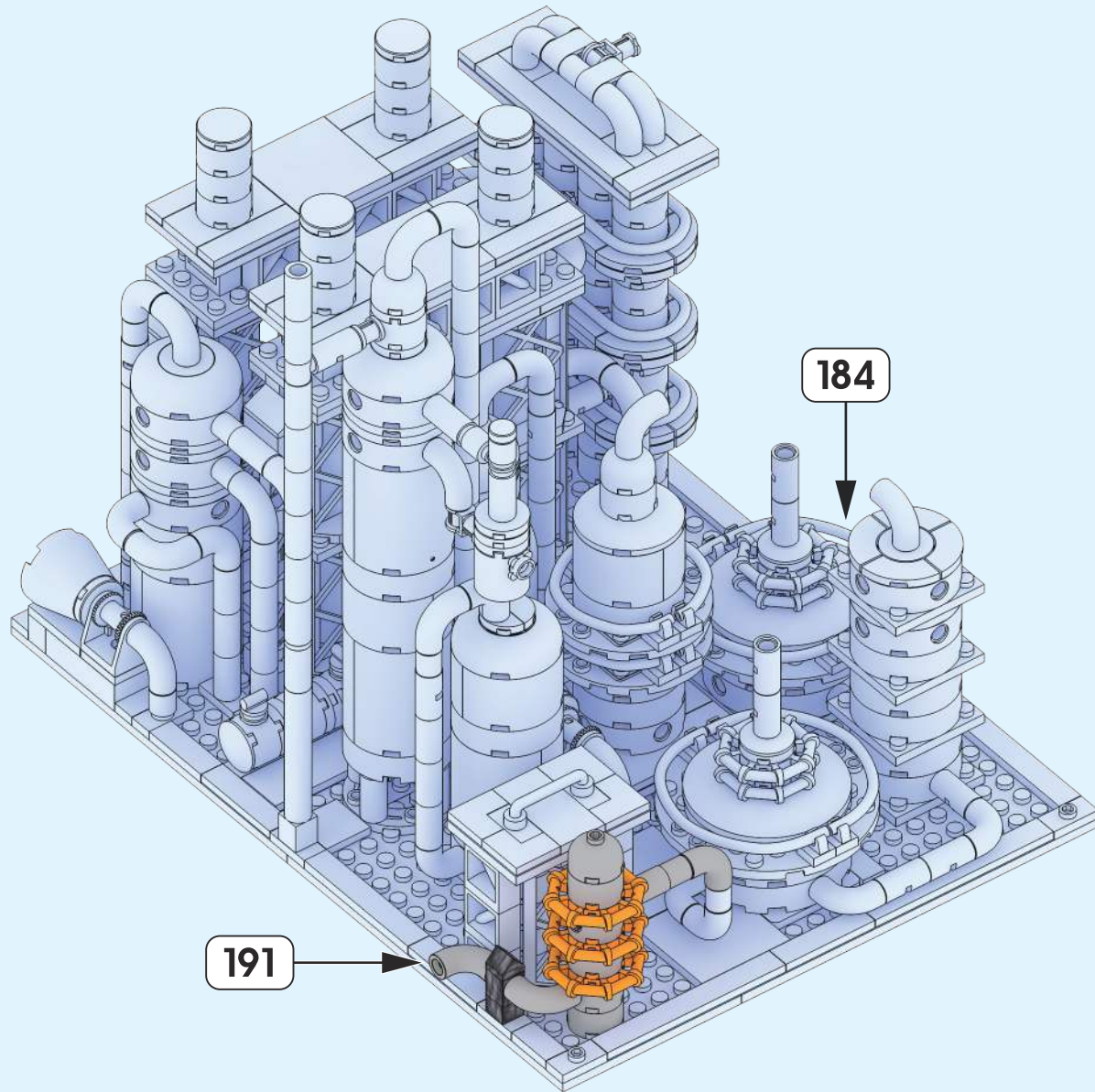

191

184

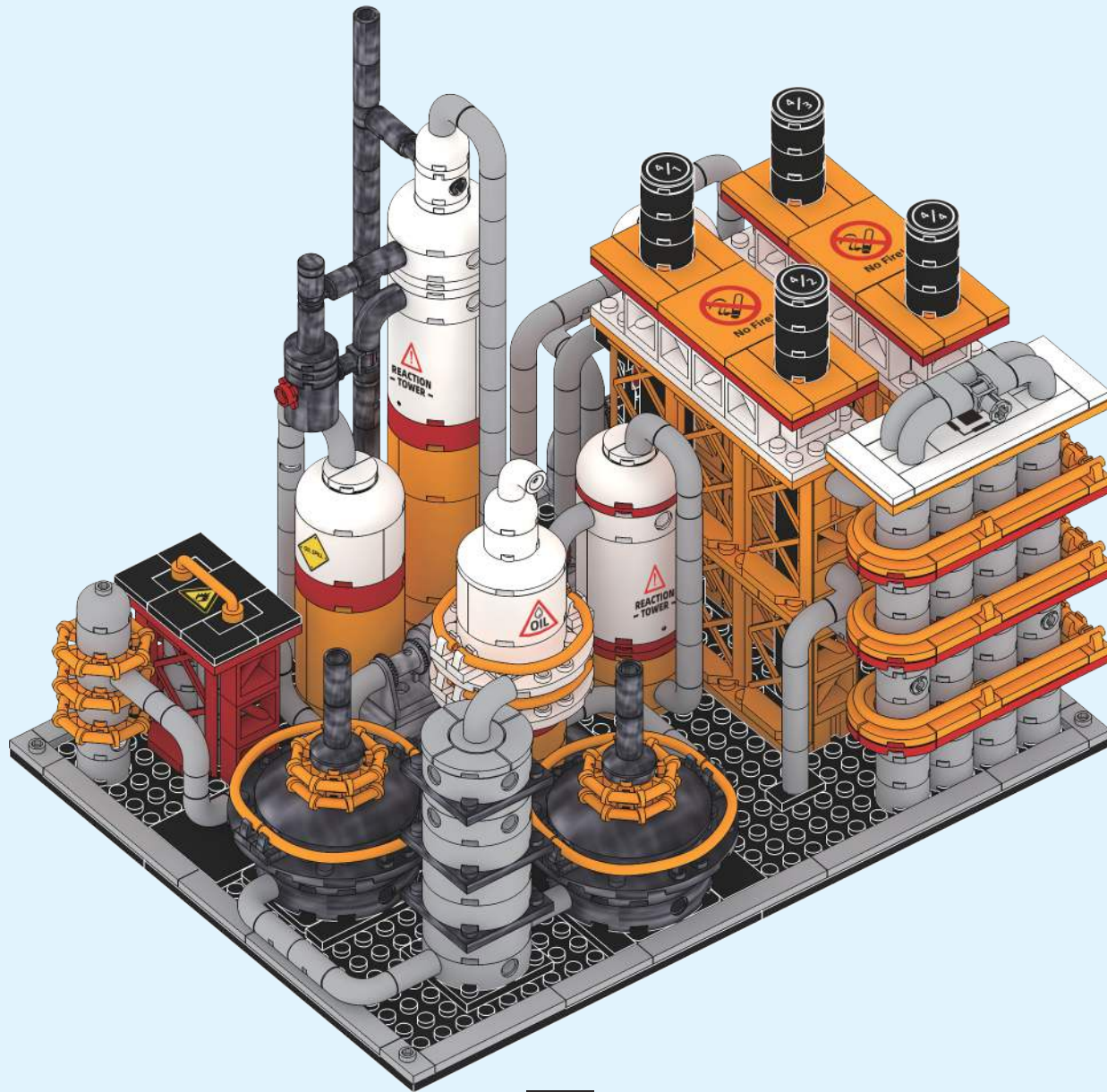

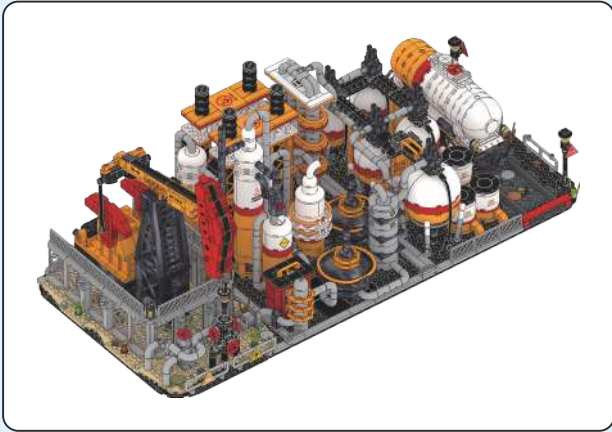

| 01 |

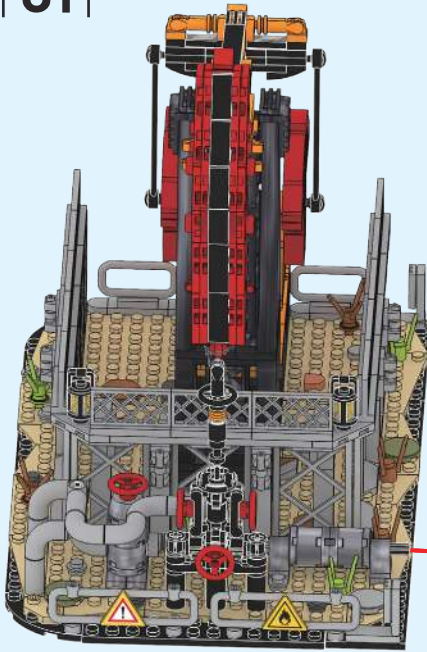

JJ9221

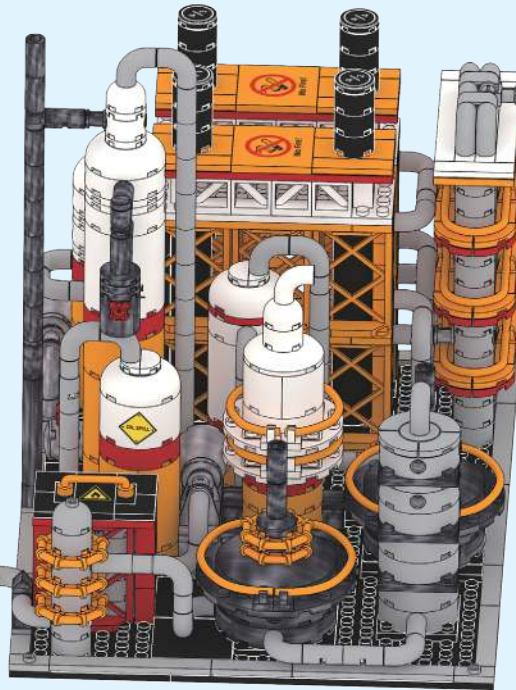

JJ9222

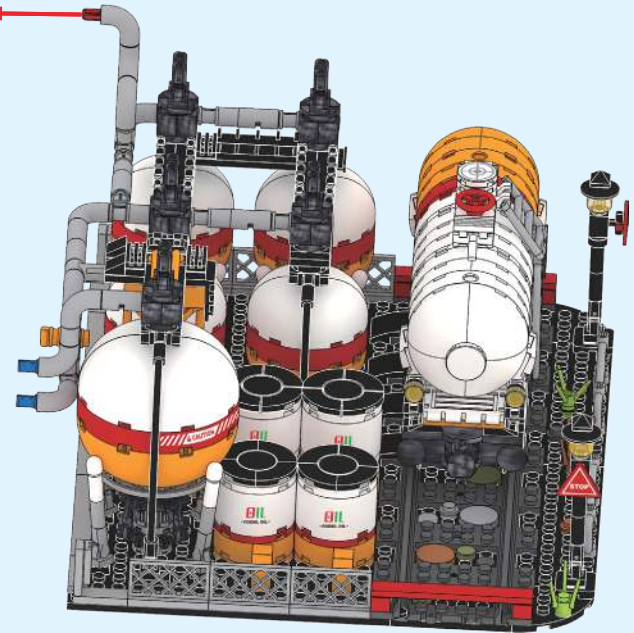

JJ9223

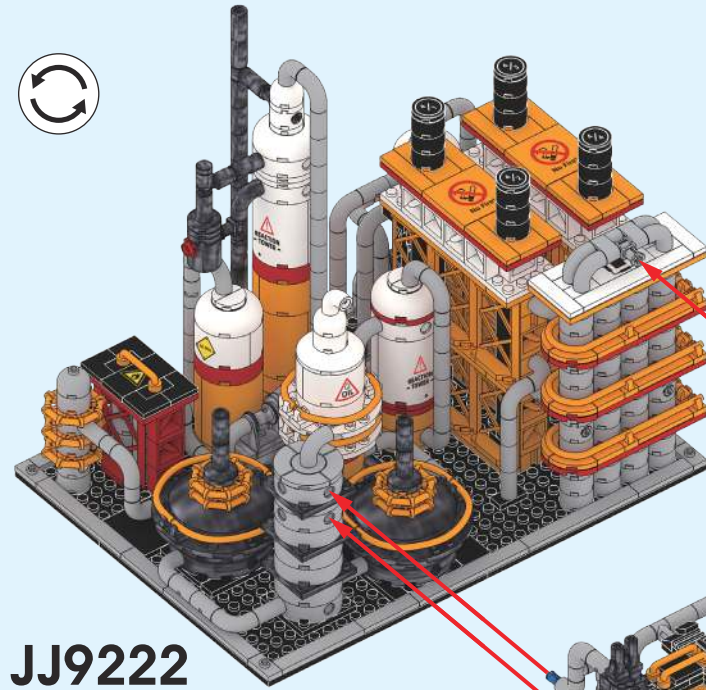

JJ9222

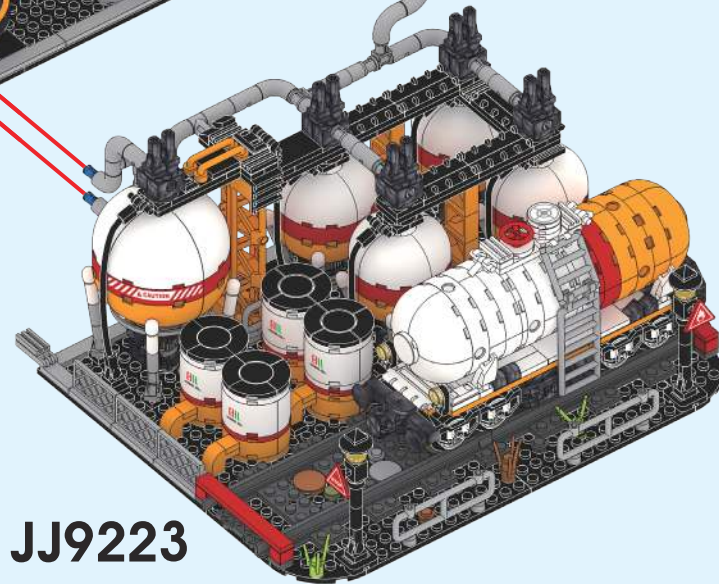

JJ9223

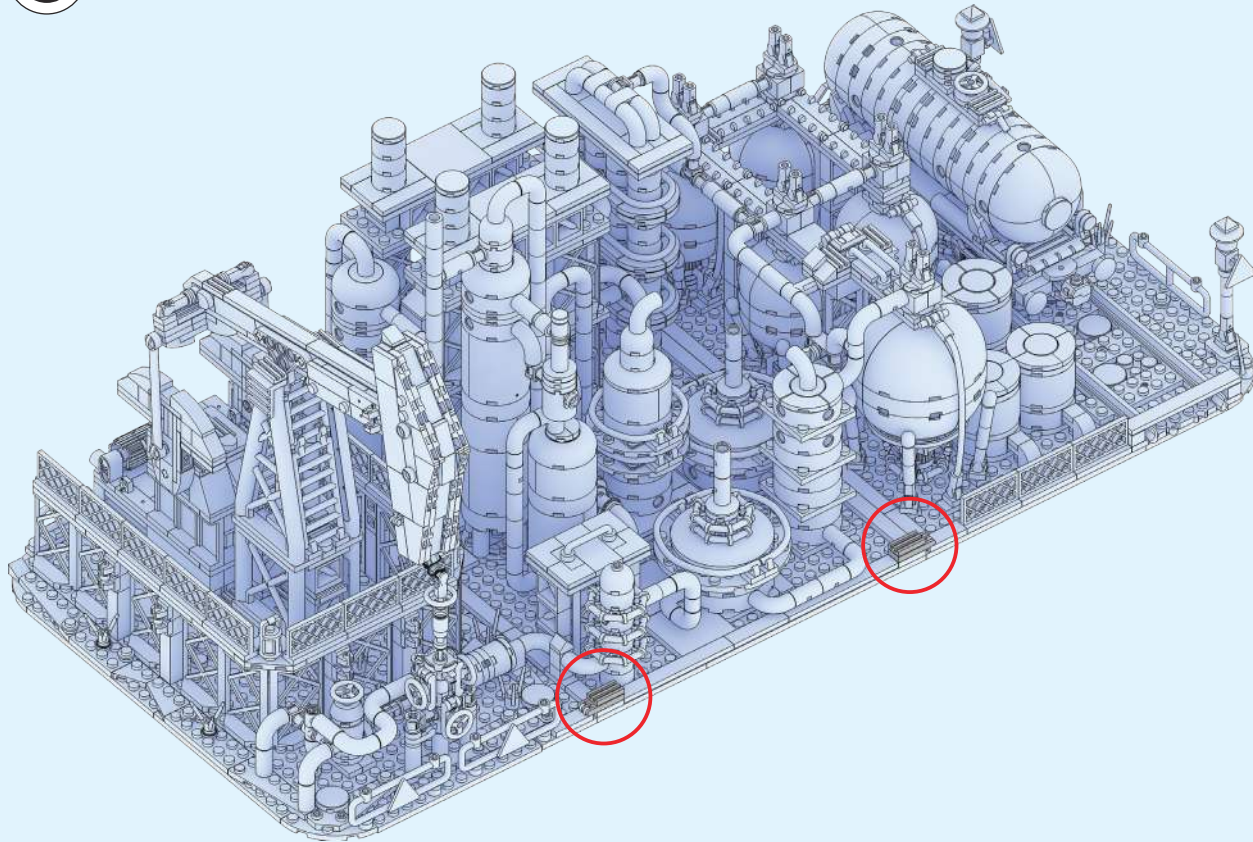

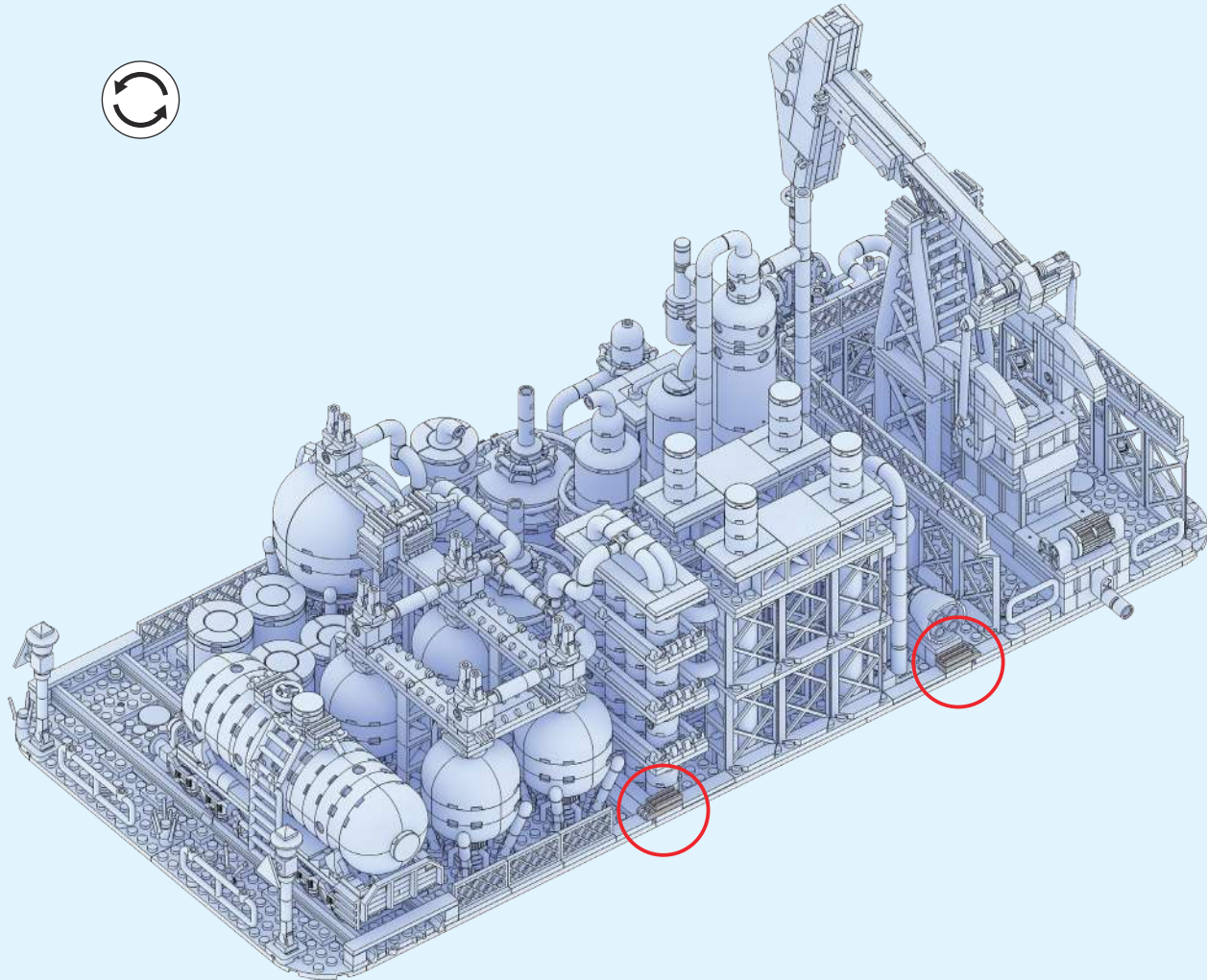

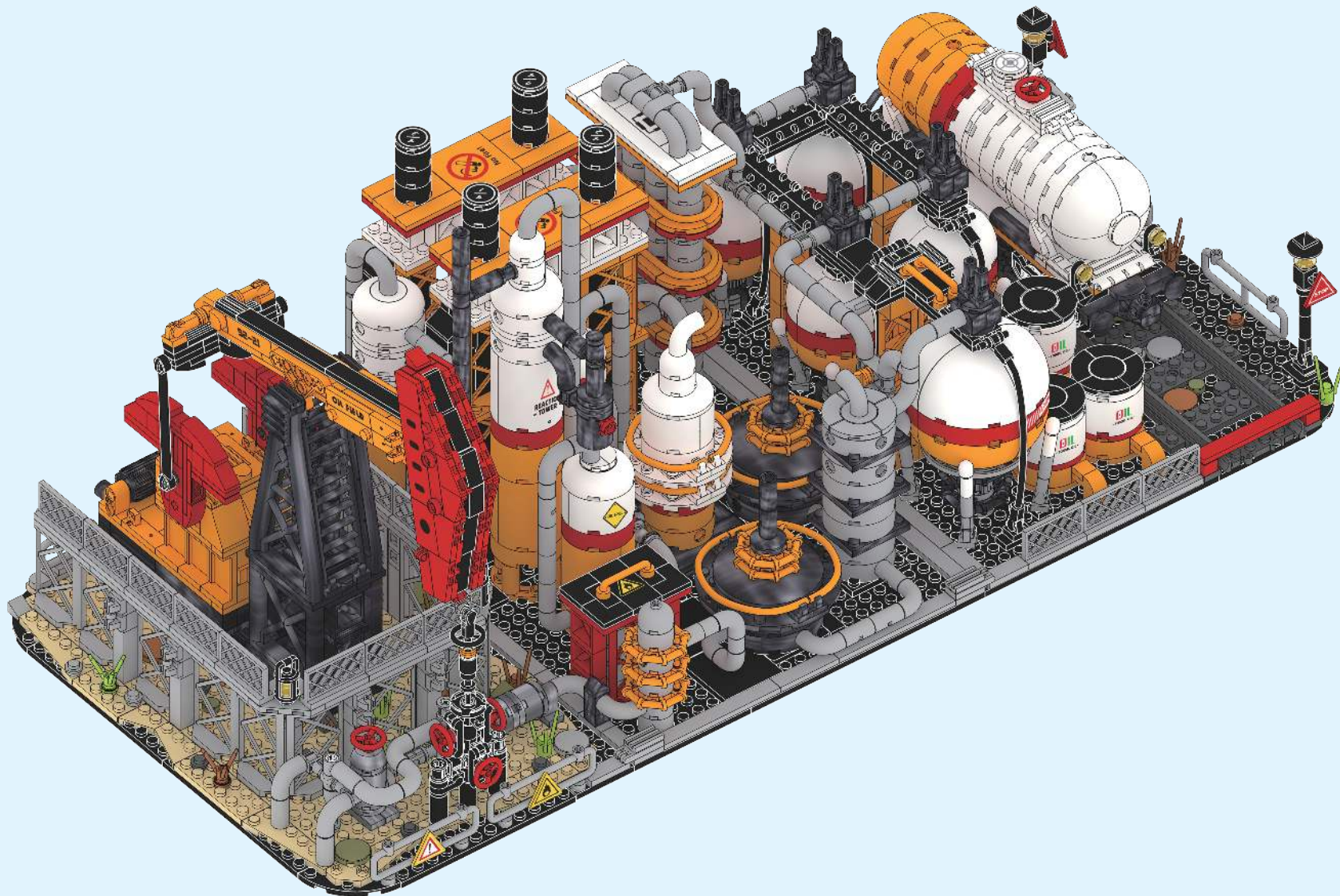

3IN1



JJ9221

+



JJ9222

+



JJ9223

**PETROLEUM
ENGINEERING**