

# The Black Pearl

| 40002 | 1755 +Pcs



JMBricklayer



*Age of Exploration*

**WARNING:** CHOKING HAZARD.  
Toy contains small parts and a small ball.  
Not for children under 3 years.

**14+**  
**AGES**



Embrace Relaxation  
Embrace Joy



Every adultescent needs a "JOY BOX".  
Please, open your JOY BOX!



Heading for joy.  
Welcome to the Unzip Club.



# The Black Pearl

## Age of Exploration

 1755+PCS

 40002

### Breakdown Summary

Эта модель — это масштабная реконструкция легендарного корабля. В наборе более 1700 деталей, включая 1000+ черных элементов, которые позволяют собрать корабль с тремя мачтами и черными парусами. Корабль оснащен 100+ мини-фигурками, включая капитана Джека Воробья и его команду. Также в наборе есть 10+ пушек и 10+ якорей. Корабль имеет 10+ отсеков и 10+ люков. В наборе также есть 10+ фонарей и 10+ флажков. Корабль имеет 10+ якорей и 10+ пушек. В наборе также есть 10+ фонарей и 10+ флажков.



Судно имеет три мачты и три паруса. В наборе более 1700 деталей, включая 1000+ черных элементов, которые позволяют собрать корабль с тремя мачтами и черными парусами. Корабль оснащен 100+ мини-фигурками, включая капитана Джека Воробья и его команду. Также в наборе есть 10+ пушек и 10+ якорей. Корабль имеет 10+ отсеков и 10+ люков. В наборе также есть 10+ фонарей и 10+ флажков.



21.65 inch



7.87 inch

16.14inch



# 11 LED LIGHTS POWERED BY USB VIA BATTERY BOX (3 AA NEEDED)





Contact us can visit [www.jmbricklayer.com](http://www.jmbricklayer.com) email [Service@jmbricklayer.com](mailto:Service@jmbricklayer.com) or via our app **JMBricklayer**

Welcome each and every one who came to discuss business cooperation via email [Business@jmbricklayer.com](mailto:Business@jmbricklayer.com).

You can find us on Facebook and Twitter to get latest products information and activities. Search **JMBricklayer** on Facebook and Twitter.

If you find something was missing or broken from your new set. We do our best to make every set perfect and we take it very

seriously when a faulty one sneaks through. Don't worry though, we can send you the parts you need!

Please upload a complete description of the part along with the set number via email: [Service@jmbricklayer.com](mailto:Service@jmbricklayer.com) or our app **JMBricklayer**

Once your part is on its way we'll send you a shipping confirmation email.

## PART ASSEMBLY ORDER



The color of the bags shown in the image is for reference only (subject to the actual product).

## BRICK COMPARISON UNITS

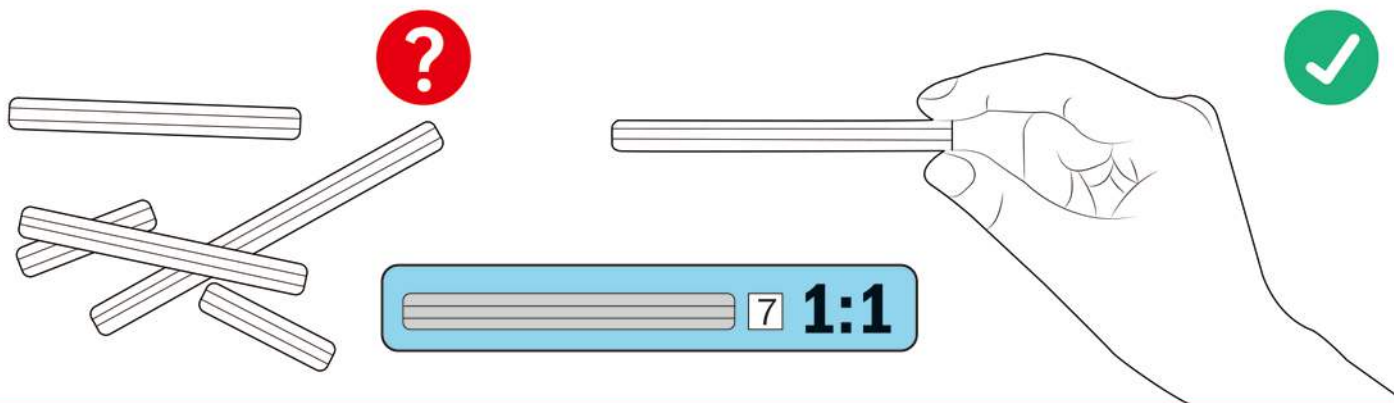

## USAGE OF BRICK SEPARATOR



**JOY** MAKES  
BRILLIANCE.

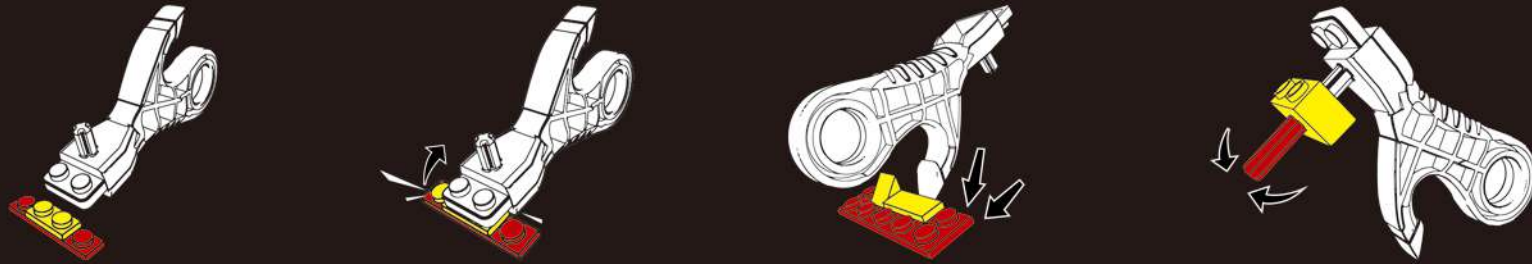

The shape and color of the accessories shown in the image are for reference only (subject to the actual product).

## STICKER INSTRUCTION

01

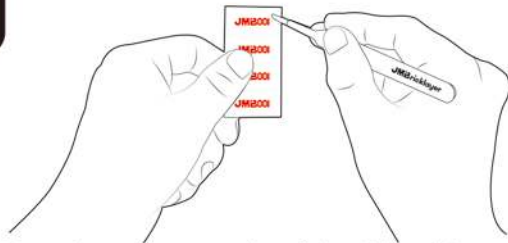

Pick up the transparent edge of the sticker with tweezers.

02

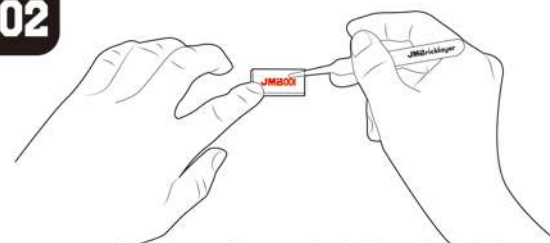

Align the position and stick it to the brick.

03

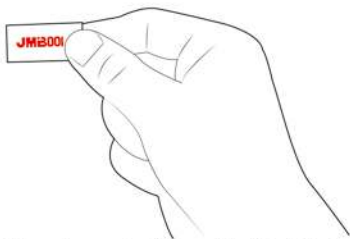

Press the sticker to make them stick tightly together.

04

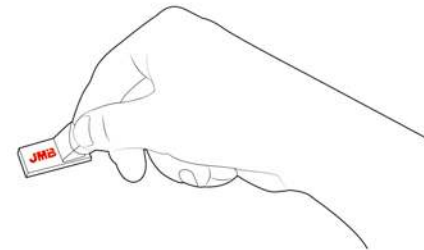

Tear off the transparent film.

**Note:** Some sets come with fully printed brick pieces, in these cases, there are no stickers/decals. Please refer to the actual product for details.

## WHAT'S INCLUDED



**JOY MAKES**  
BRILLIANCE.



Building Bricks



LED Light kit

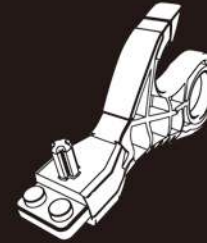

Brick Separator



User Manual

## LED LIGHT KIT PACKAGE LIST

Please check carefully and ensure all the lighting accessories are inside the package. Please contact us if there is any missing components.

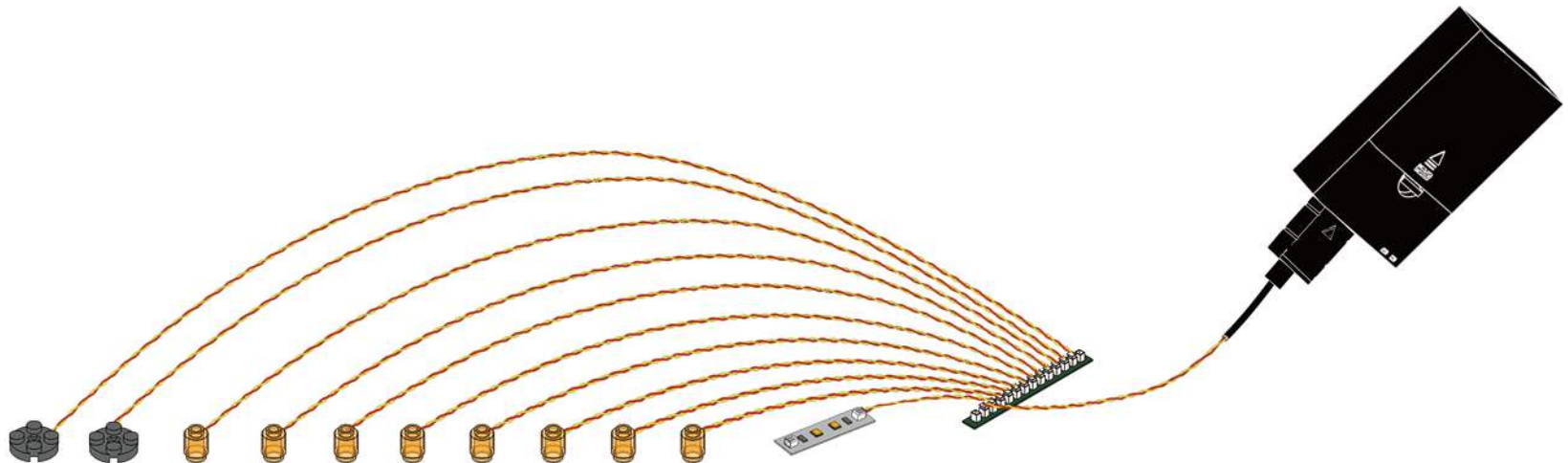

**Note:** Please take out and install your led lights carefully, no hard pulling, no bending or shaking, otherwise it might damage the lights.

# USER INSTRUCTION

Please read the following carefully before installing the lights.

**CAUTION:**

Different types of batteries should not be used together. This includes mixing old and new batteries, as well as mixing alkaline, carbon-zinc, and rechargeable nickel-cadmium batteries.

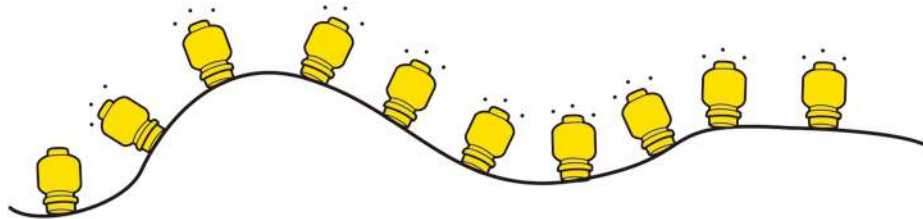

Before installing, please connect to the power supply and test the lights to make sure everything functions properly. If the lights do not work, please refer to the TROUBLESHOOTING or contact us.

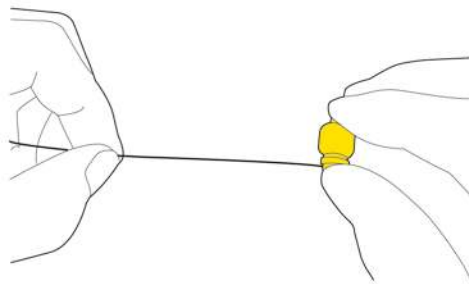

LED components are delicate, so please take extra care when installing, no hard pulling, no bending or shaking.

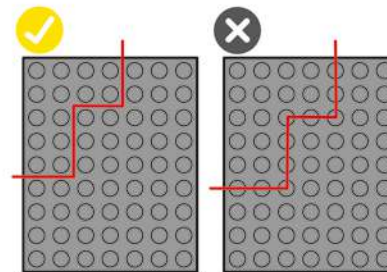

Hide the spare wire under the bricks: when installing. Please make sure that the wire is laid between two studs of the bricks, but not pressed by the bricks directly.

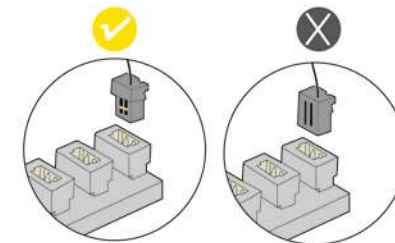

Connectors can be inserted into ports of the expansion board in only one certain way. Make sure the plug's direction is correct before connecting.

Tips: if plug doesn't fit easily into a port, don't force it.

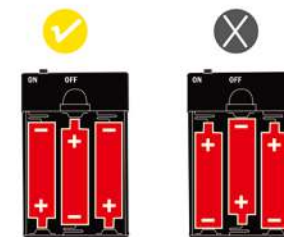

If you use a battery box to power up the lights, you'll need to prepare 3 AA batteries which are not included in this package. For better result, new/unused batteries are recommended. If the battery is not going to be used for an extended period, please remove it from the battery case.

# BATTERY BOX USER GUIDE



**JOY MAKES**  
BRILLIANCE.

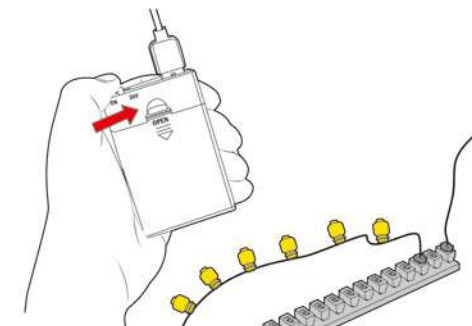
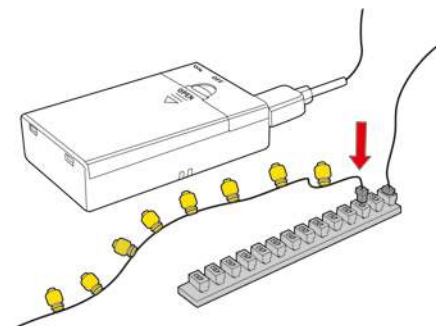
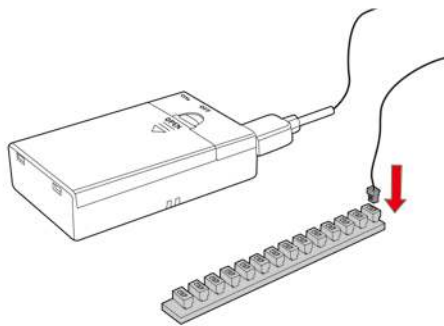
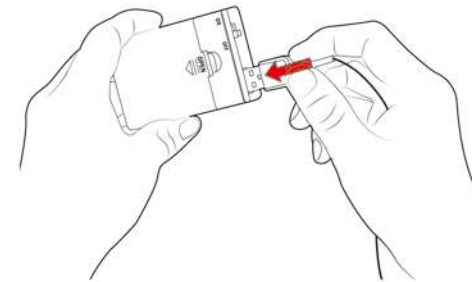
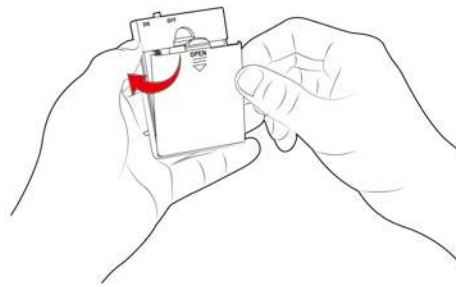
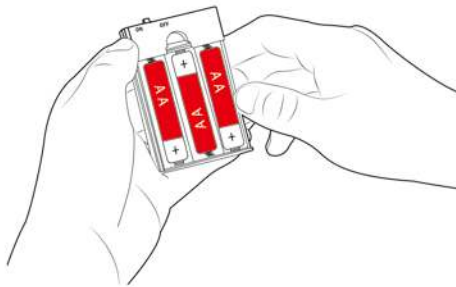
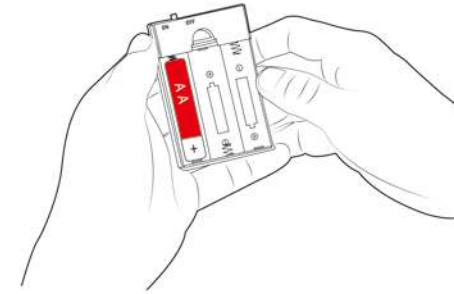
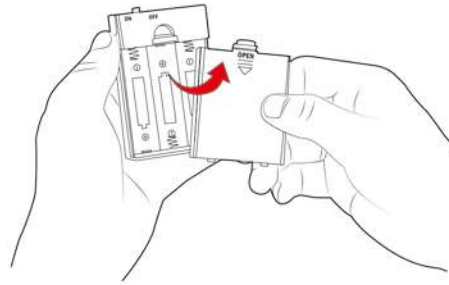
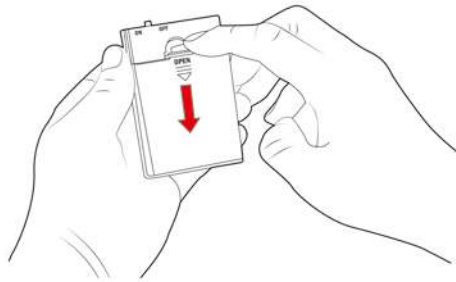

**BATTERY BOX NAME:** AA/No.5 Block Battery Box

**BATTERY TYPE:** AA\*3(No.5)

**BATTERY RATED VOLTAGE:** 1.5V

## TROUBLESHOOTING



**JOY MAKES**  
BRILLIANCE.

Due to their small size, lighting accessories are susceptible to damage during installation. Common causes of failure include:

If you have checked each string of lights according to the guide above and the lights are still not working, please contact our customer service for assistance.

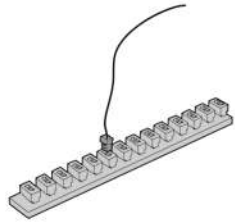

Ensure that the connectors are correctly installed as shown in the picture.



Check if the wires are disconnected or broken from the solder joints.

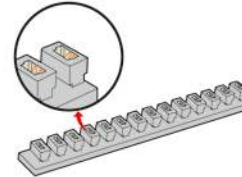

Check the internal pins of the expansion board. The internal pins of a properly working port should be straight, if the small pins are bent, they may be considered faulty ports.

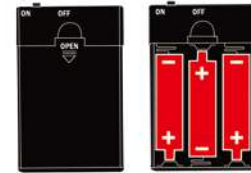

Check that the power switch on the battery box is on and that the "+" and "-" poles of the battery are correctly placed (using new batteries) and ensure that the upper and lower connections to the "+" and "-" poles of the power switch are installed correctly.

## SAFETY PRECAUTIONS

- 1 Before use, verify the voltage to avoid damage to the product and potential safety hazards. The light set must only be powered by a 5V DC (or lower) power supply. Otherwise, the resistors may overheat and burn out, shortening the lifespan of the LED beads.
- 2 The lights in the product are not replaceable. If they are damaged or not lighting up, please refer to the troubleshooting section or contact our customer service for assistance.
- 3 Avoid pulling on the lighting wires as this may cause damage.
- 4 Do not expose the product to water as it may damage the product.
- 5 If the plug does not fit easily into the ports on the board, reverse the direction and insert it again to avoid damage and short circuits, rather than forcing it in.
- 6 Please read and follow the instructions carefully during building to ensure a good building experience.

# COLOR COMPARISON



**JOY MAKES**  
BRILLIANCE.

The color used in this manual is slightly different from the actual color of the parts. The white background photo in the legend below is the actual part, you can refer to the following diagram to identify the parts.

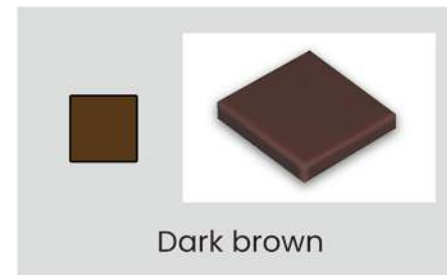
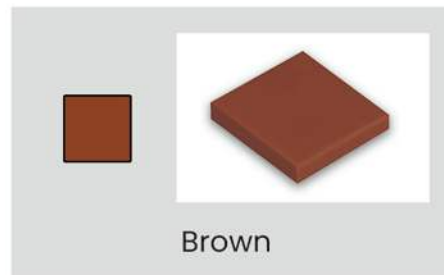
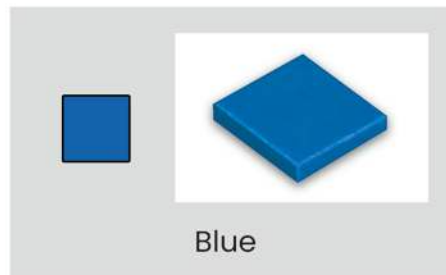
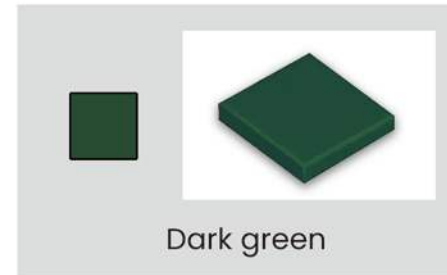
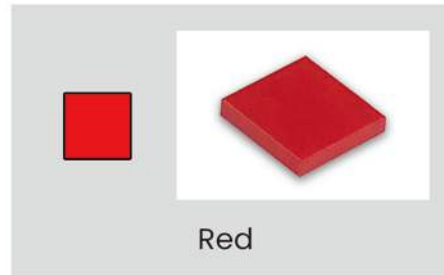
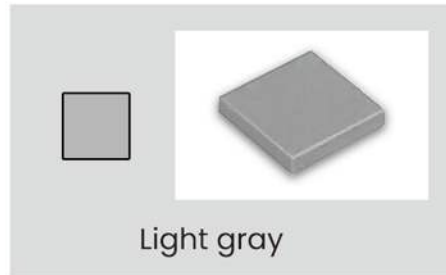
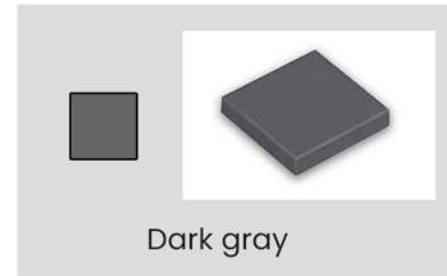
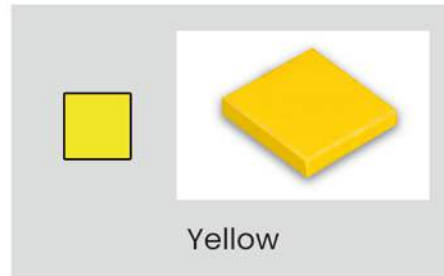
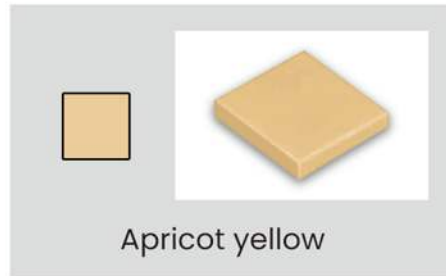

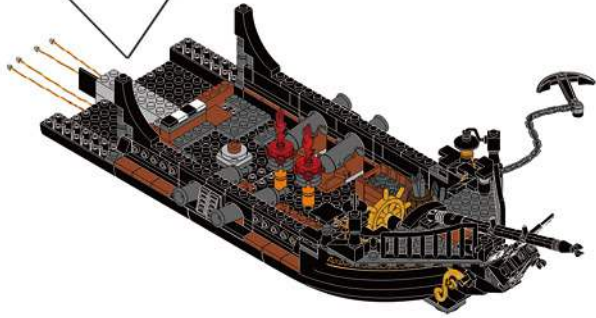
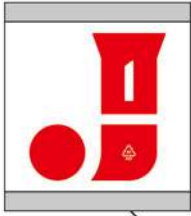

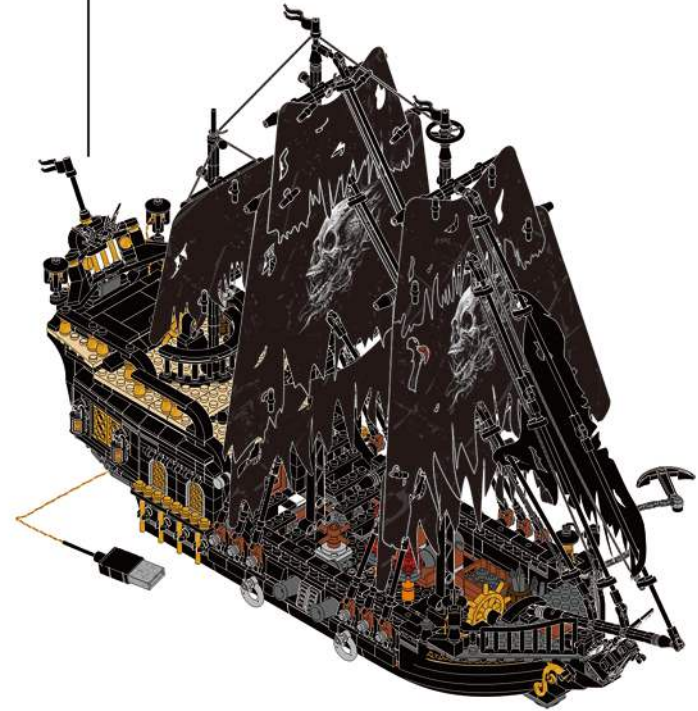
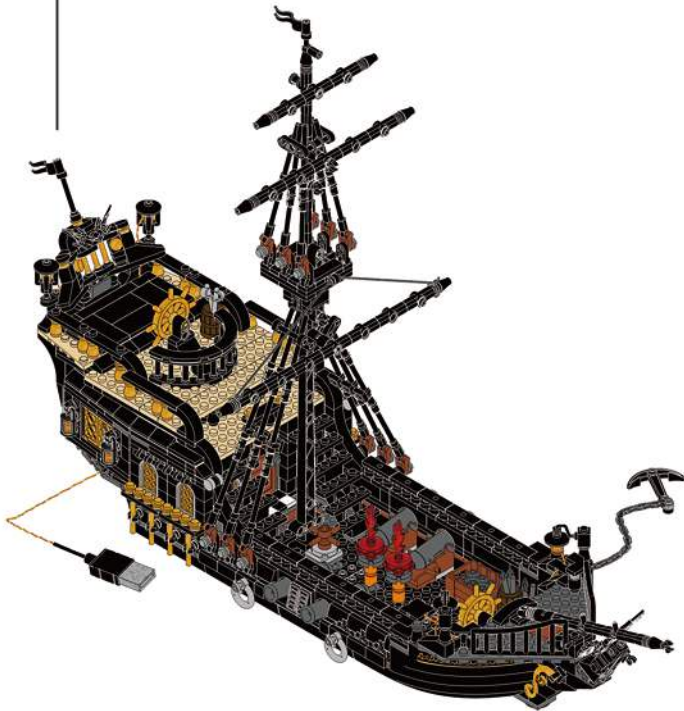

# JOY MAKES BRILLIANCE.

## Embrace Relaxation Embrace Joy

Every adultescent needs a "JOY BOX".  
Please, open your JOY BOX! Heading for joy.

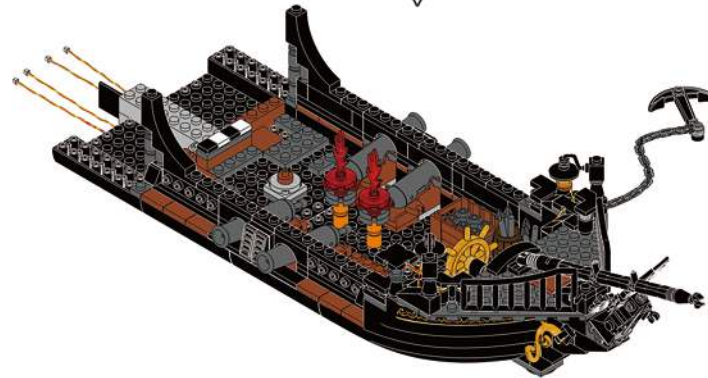

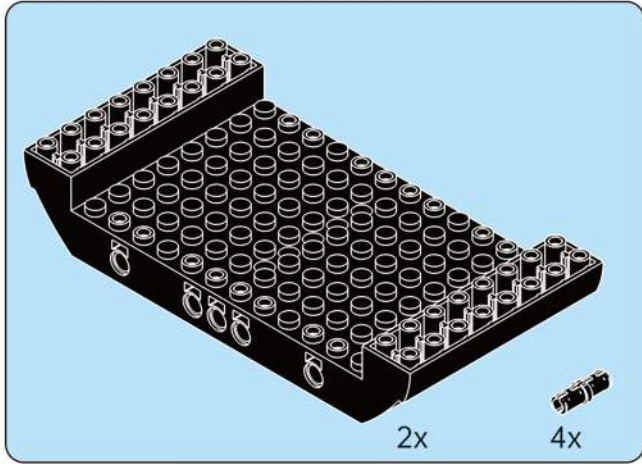

01

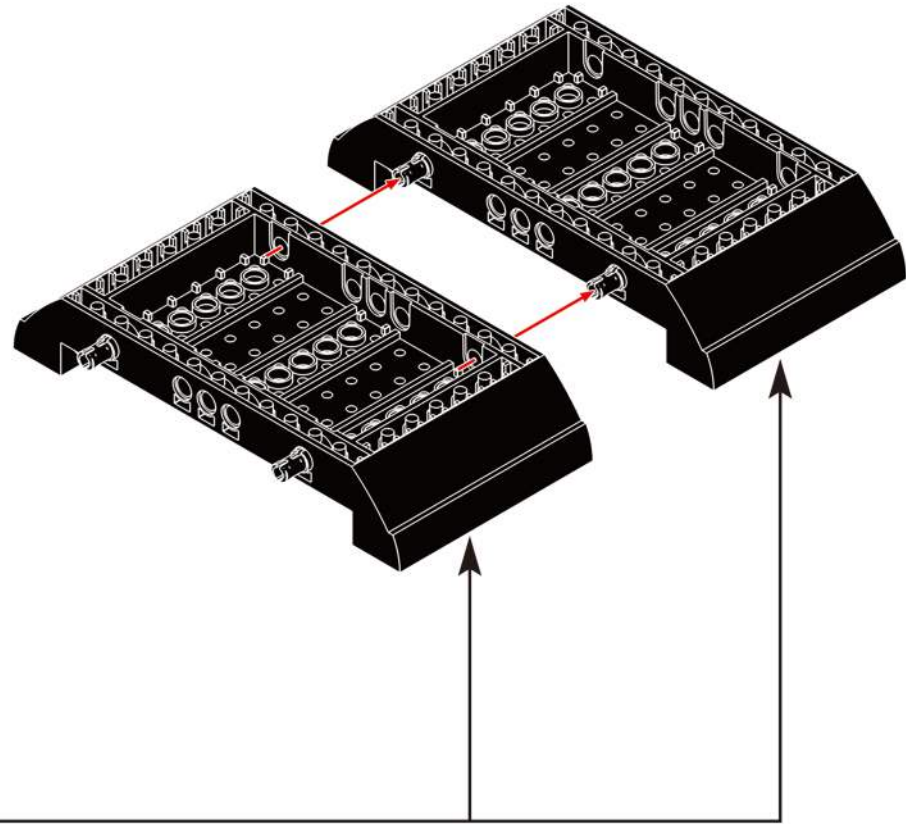
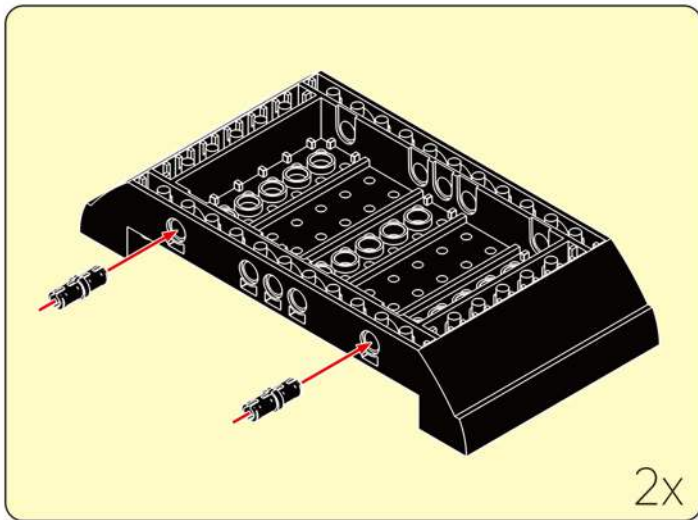

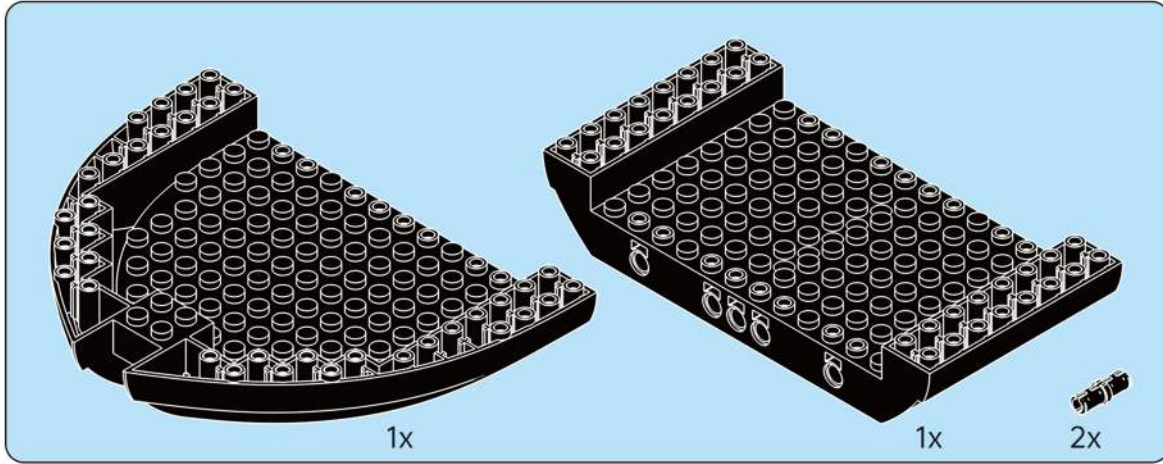

02

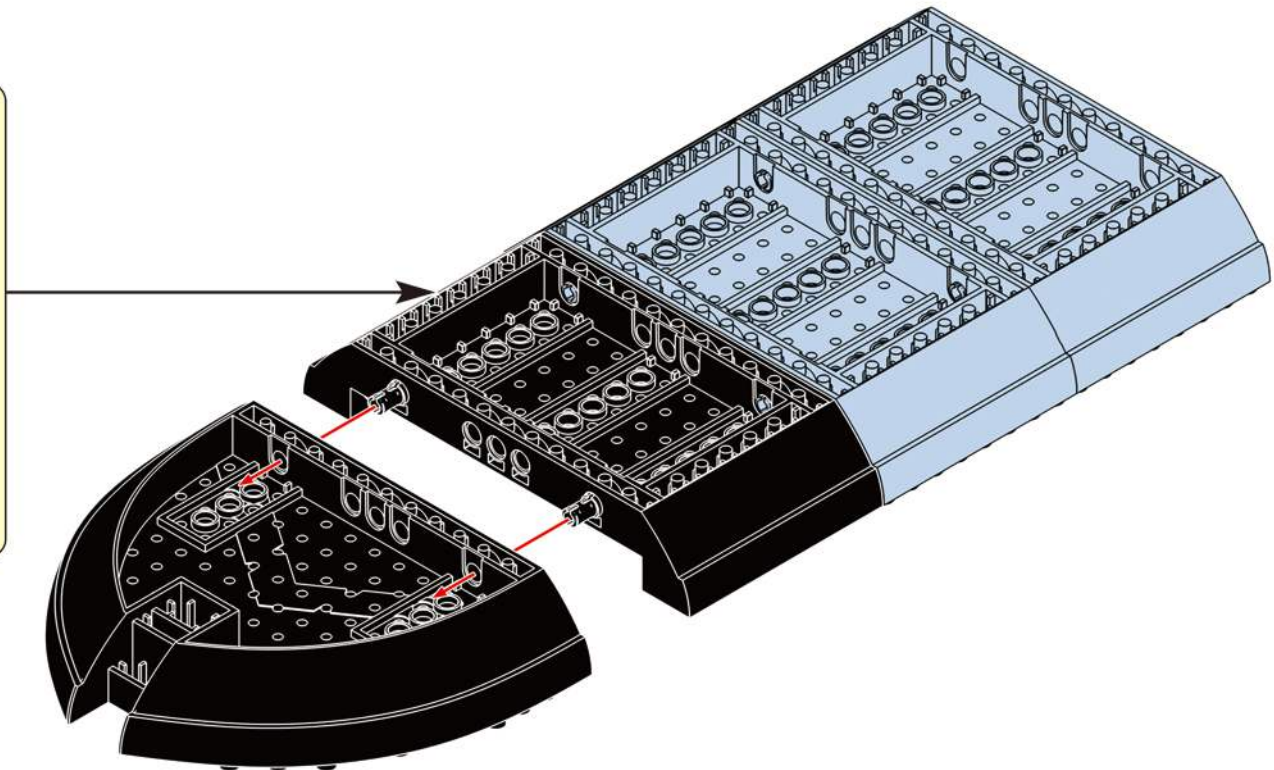
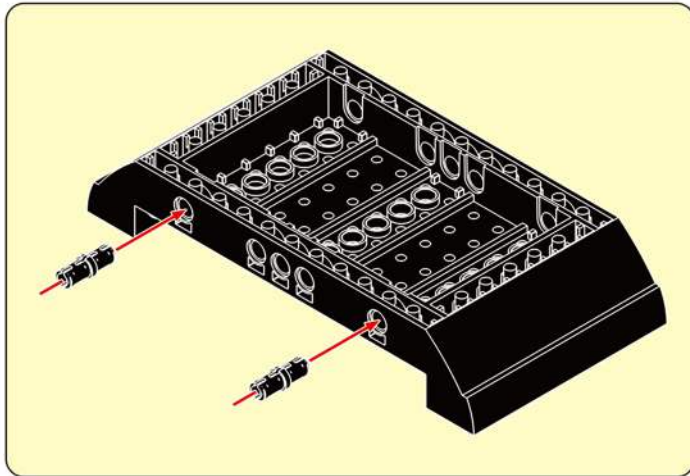



03

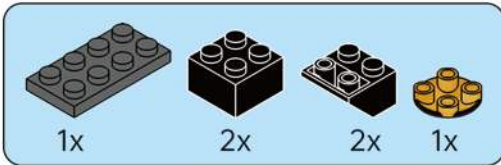
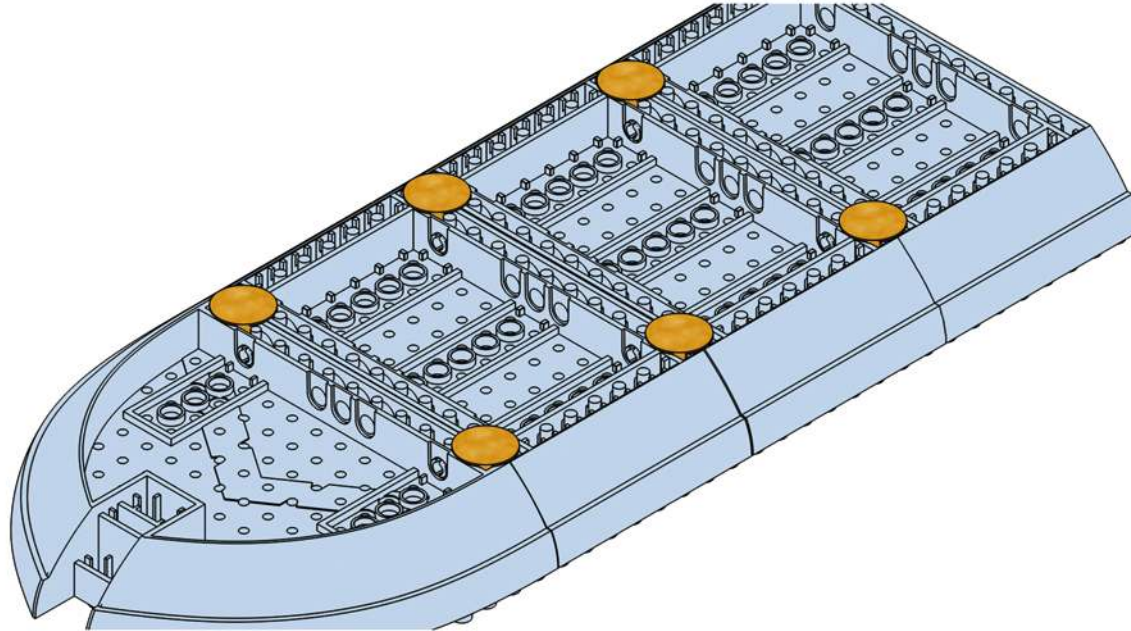

04

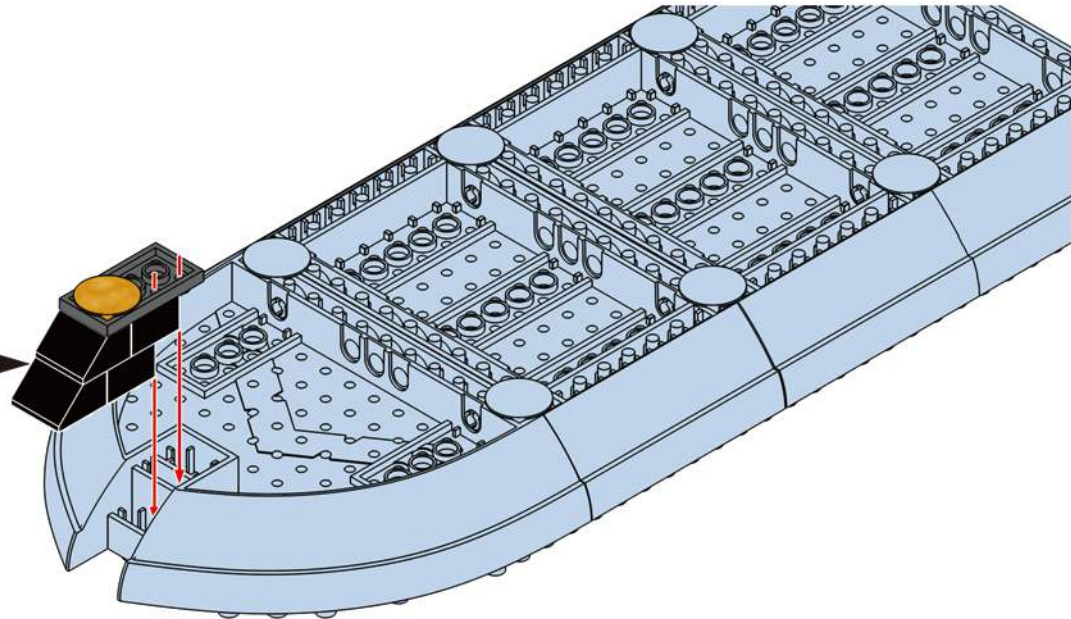
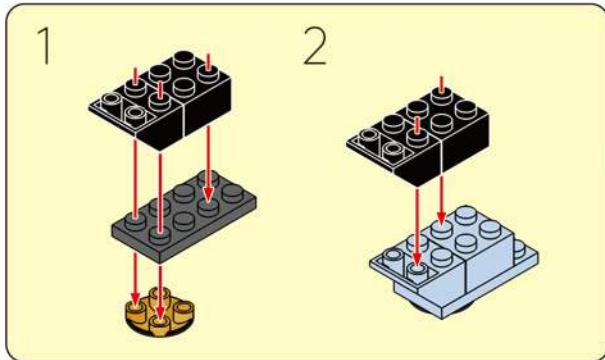

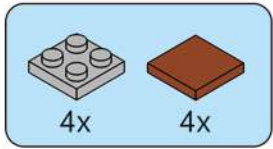

05

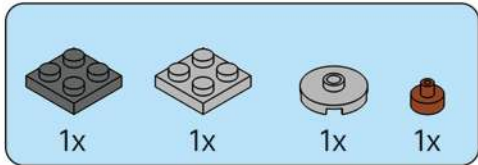
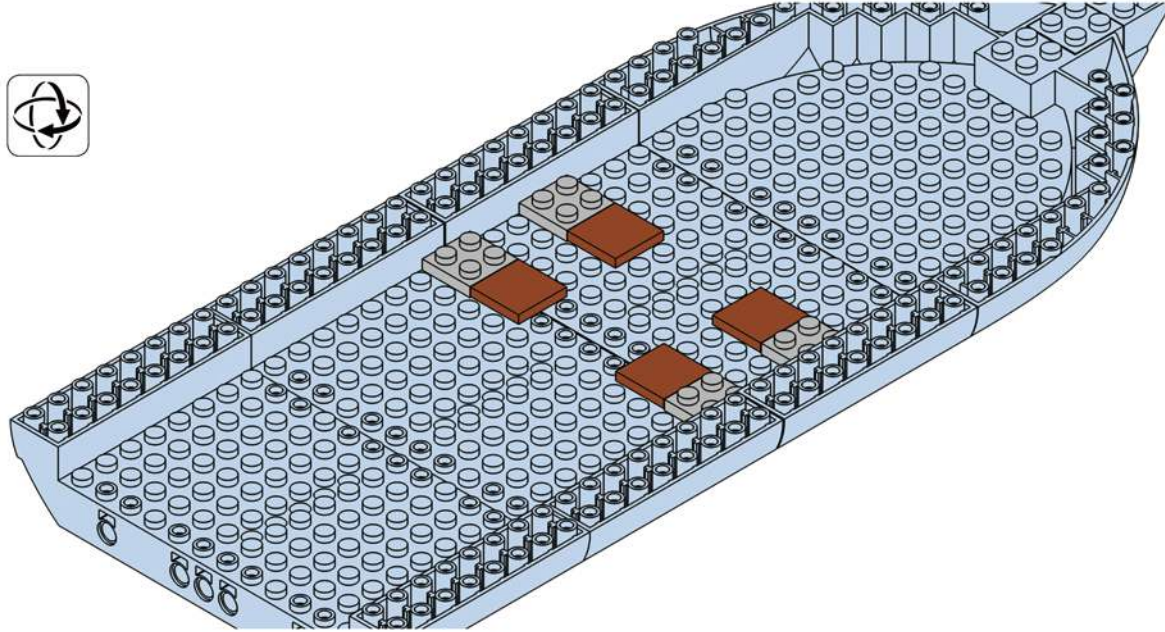

06

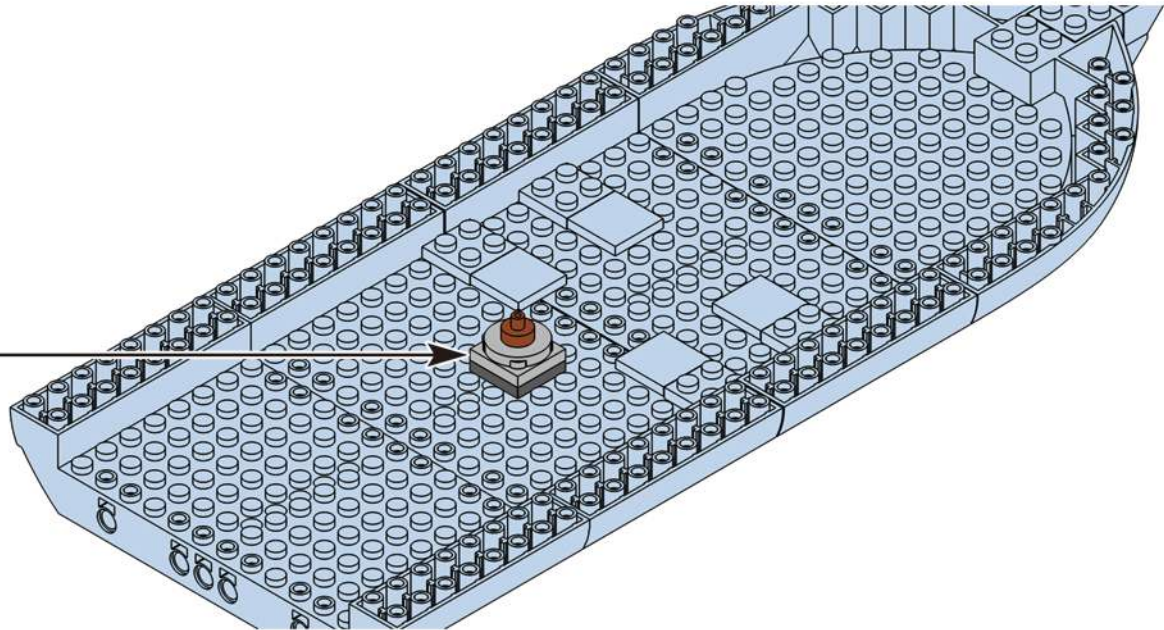
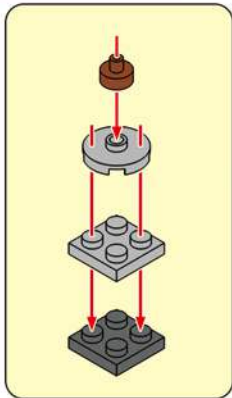

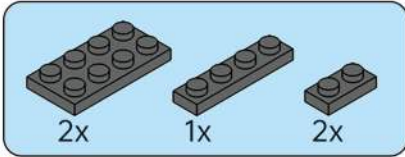

07

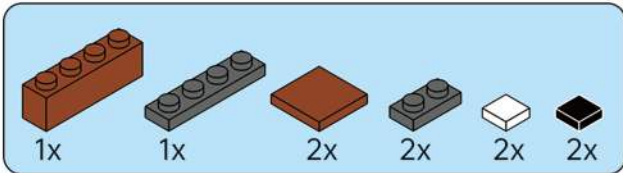
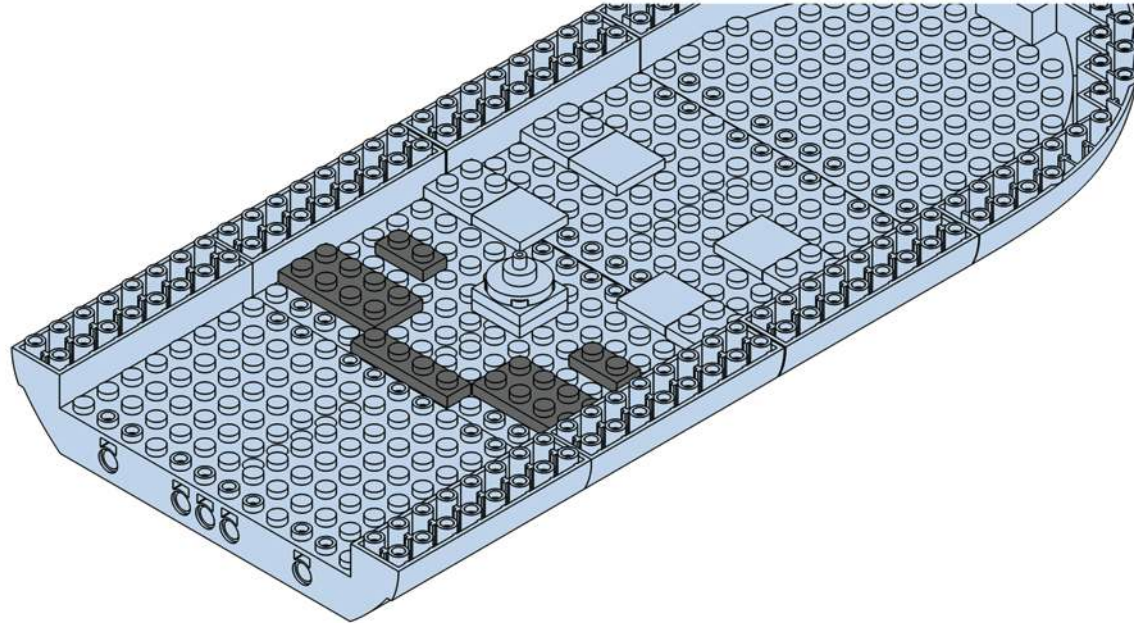

08

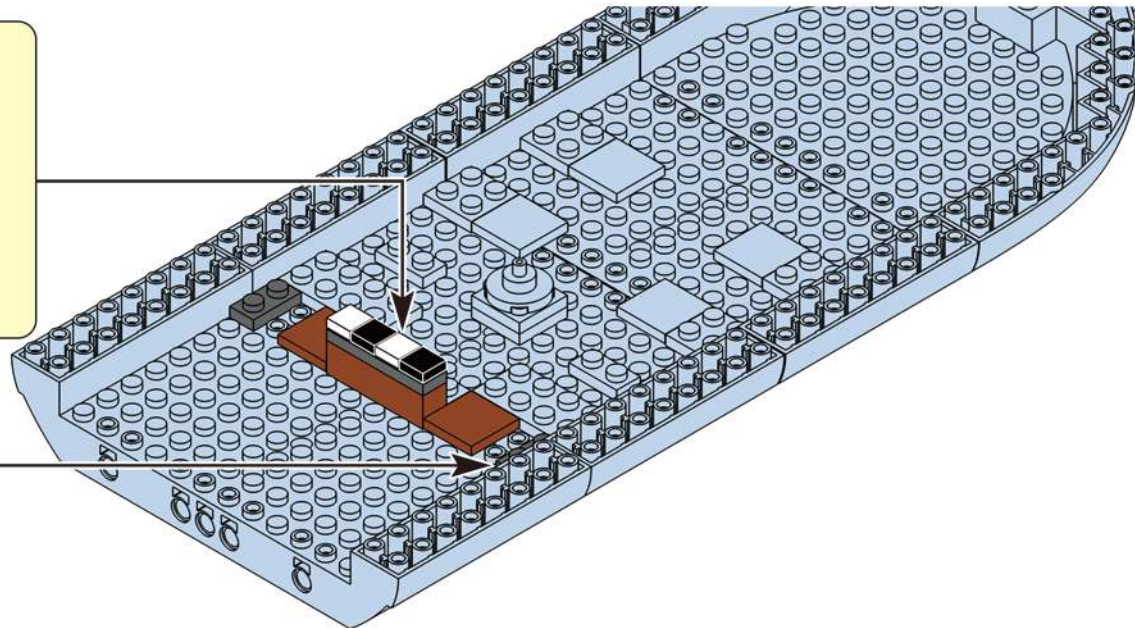
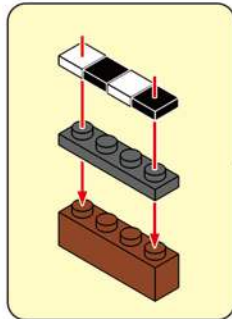
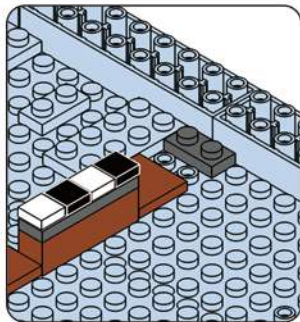

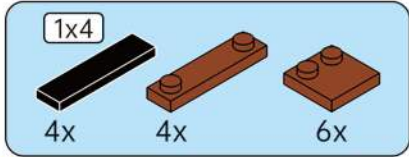

09

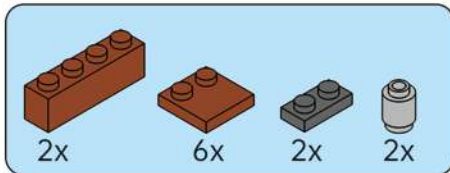
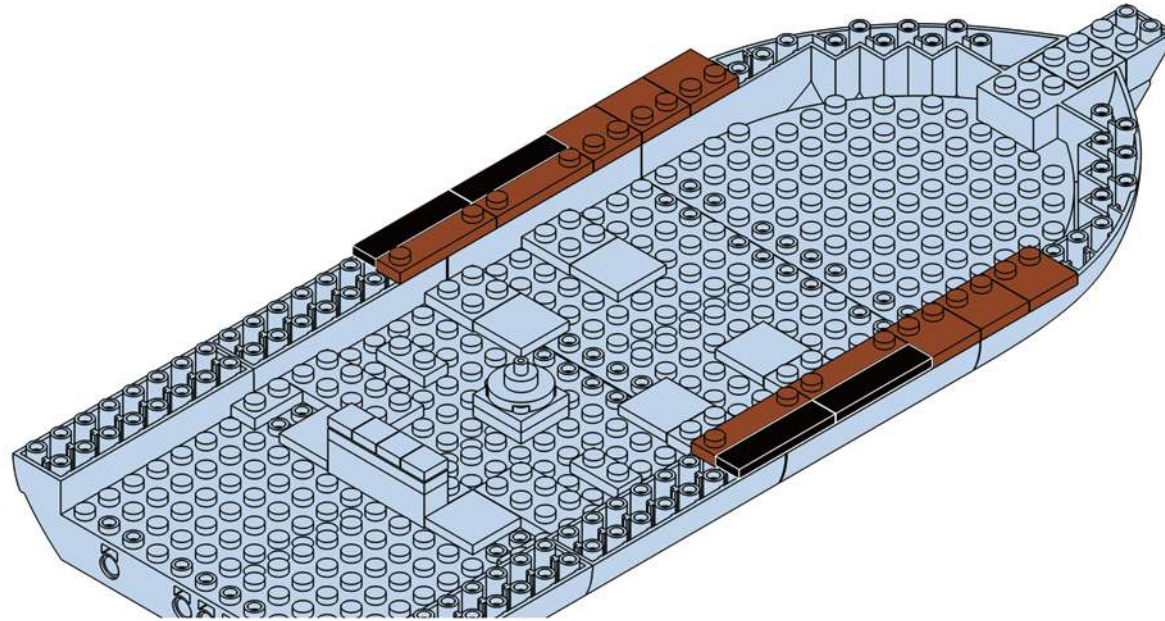

10

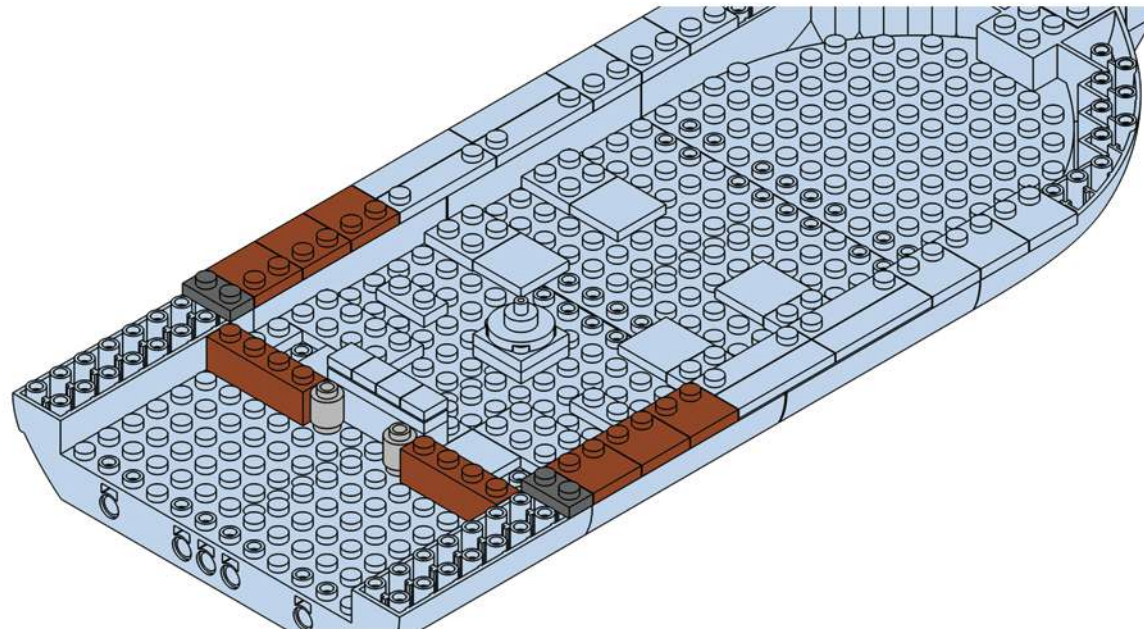

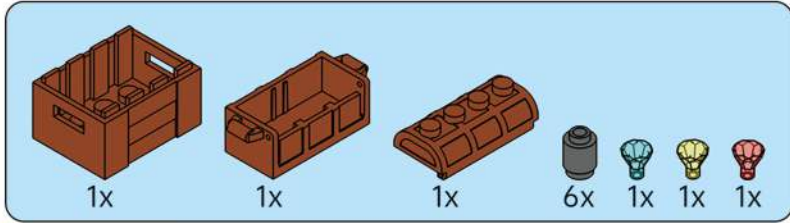

11

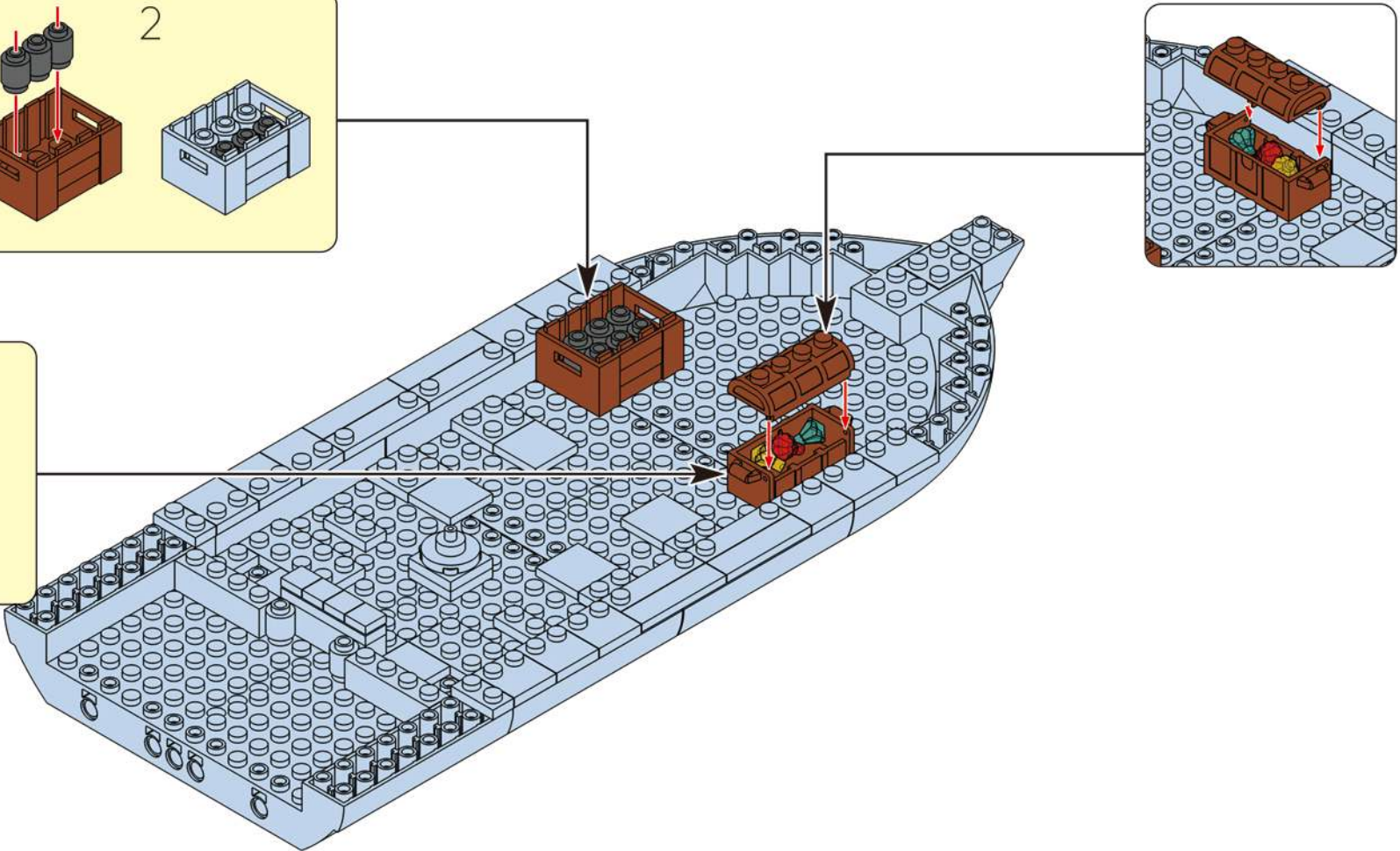
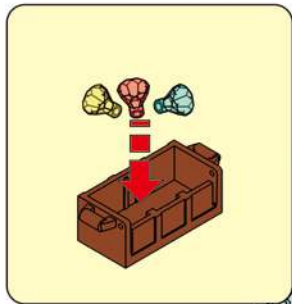
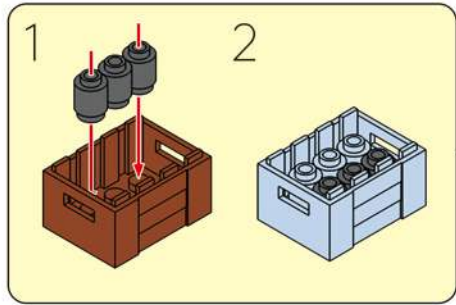

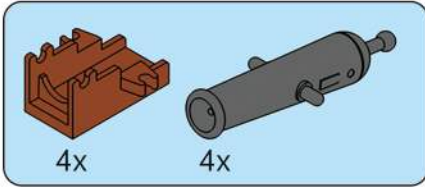

**12**

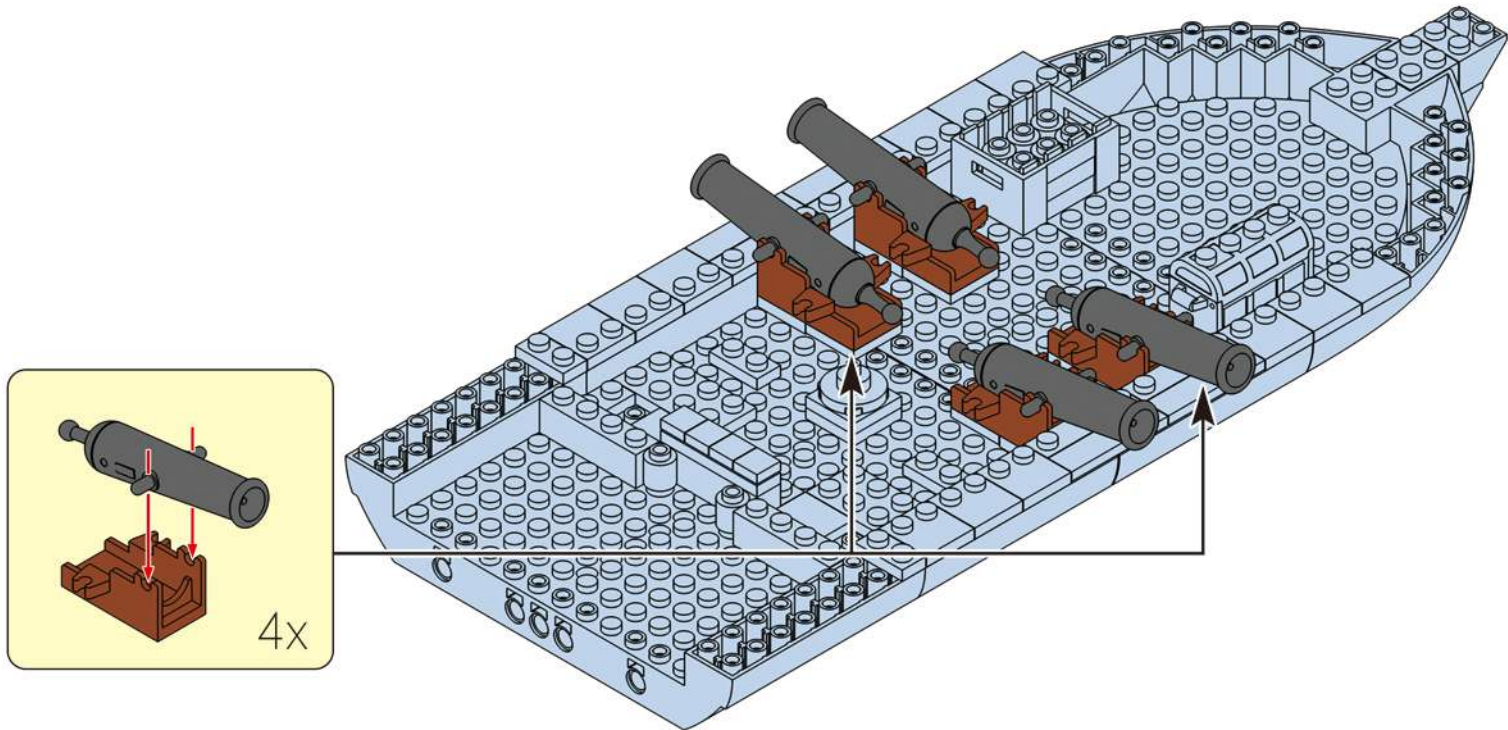

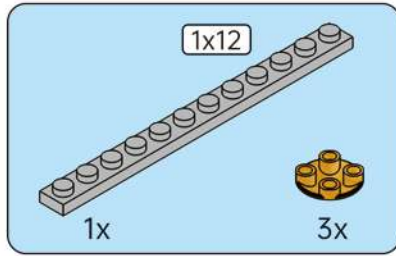

**13**

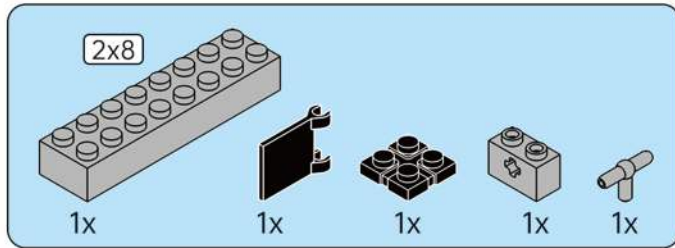
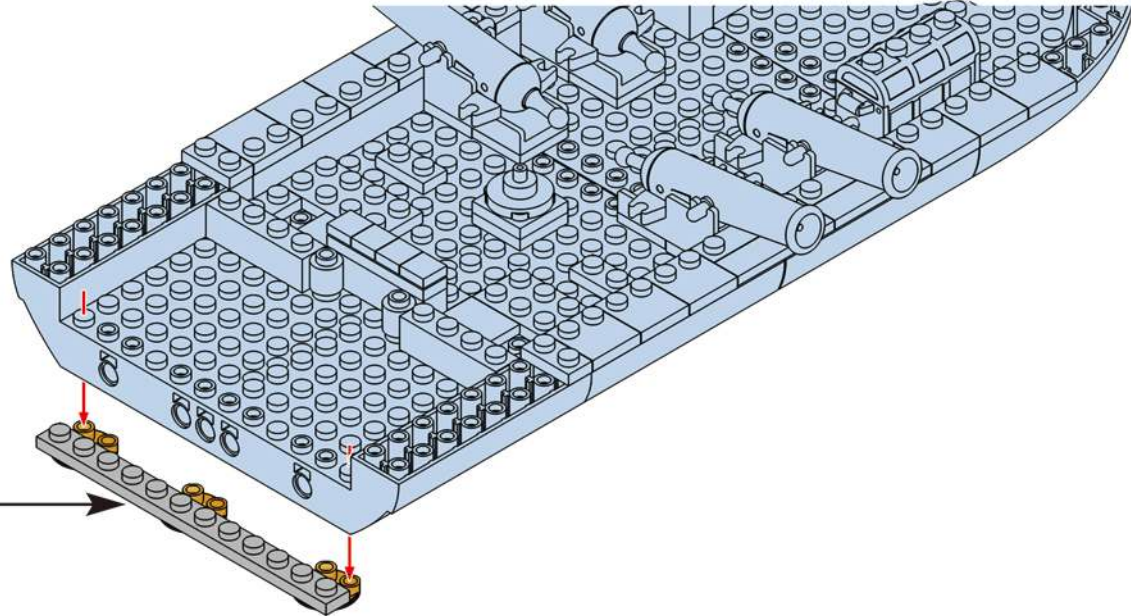
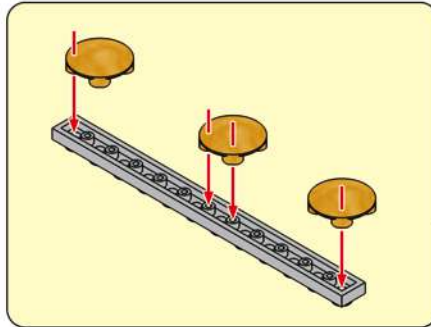

**14**

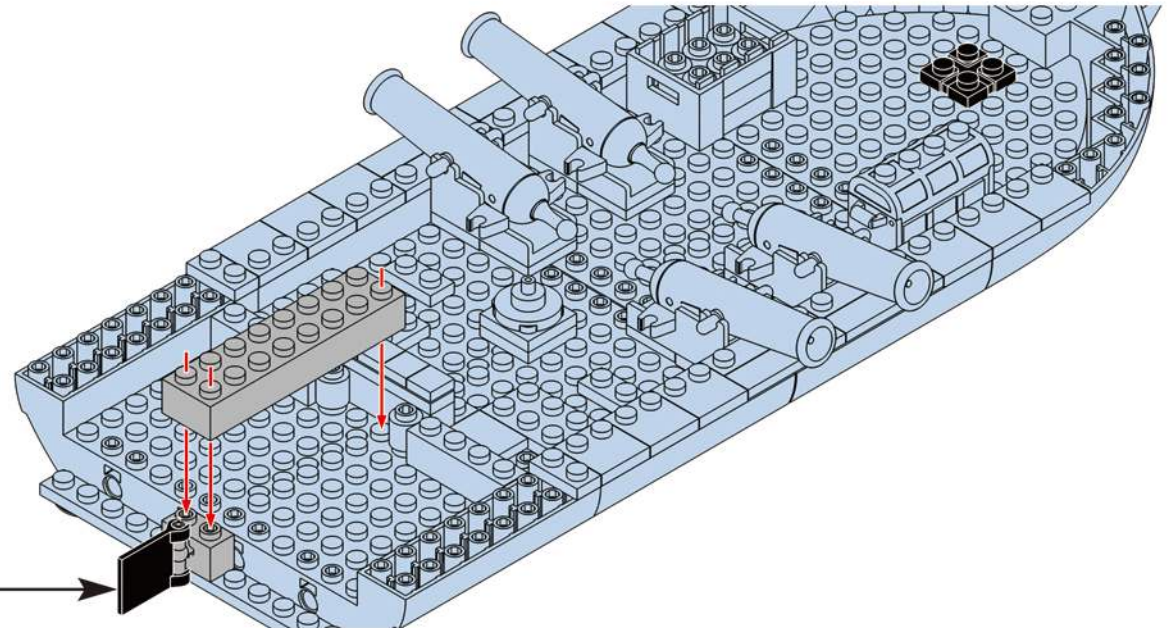
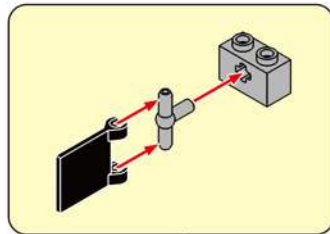

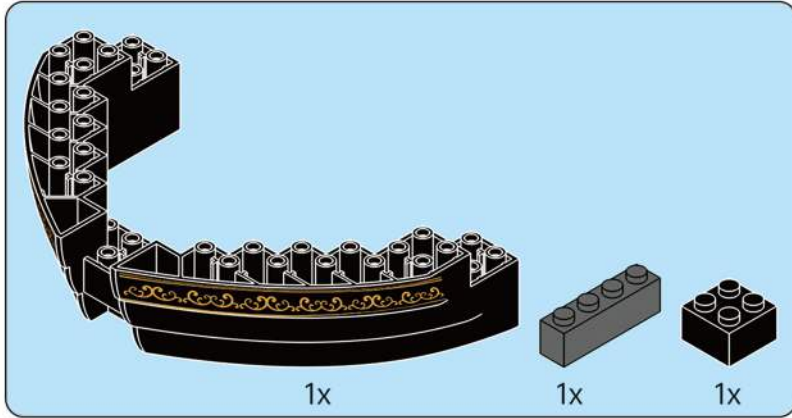

15

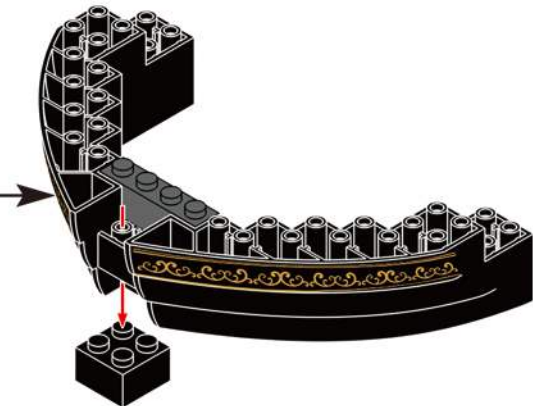
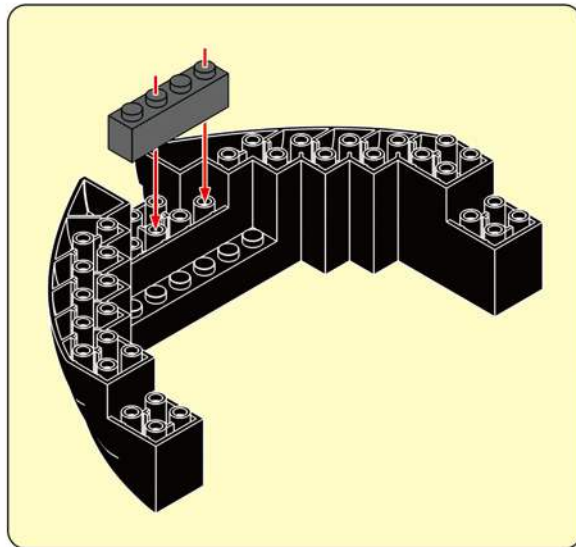

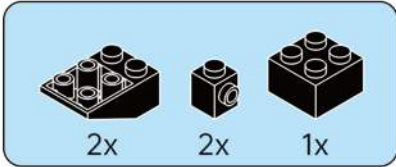

16

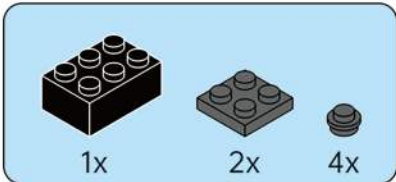
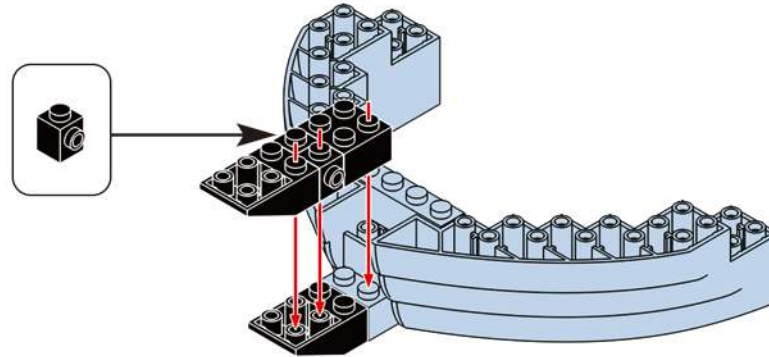

17

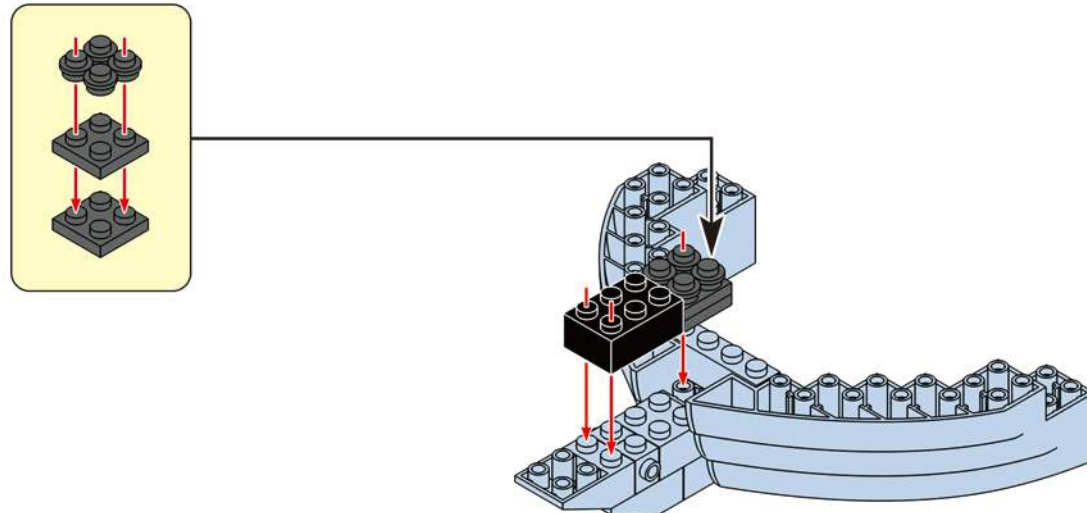

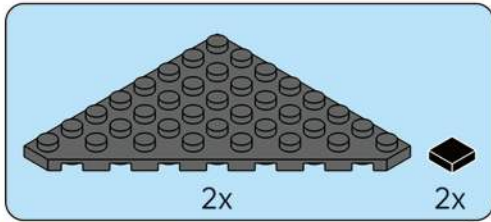

18

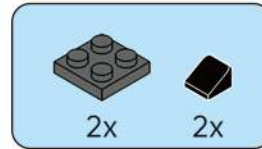
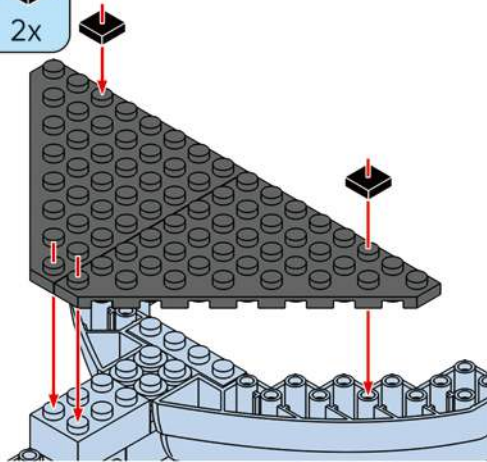

19

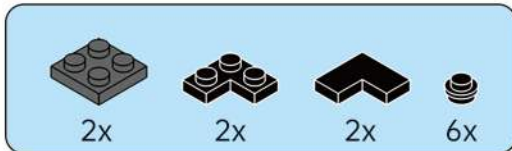
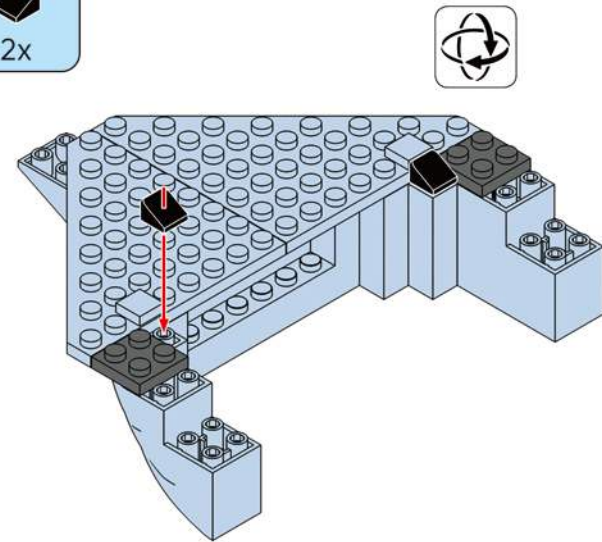

20

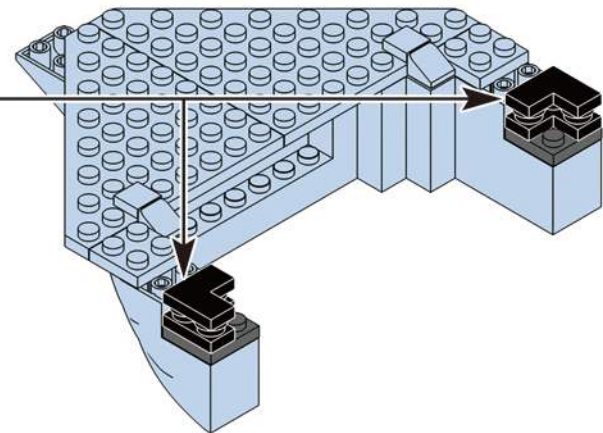
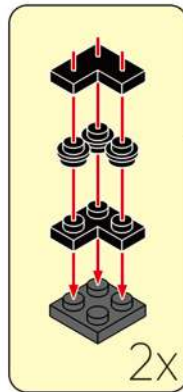

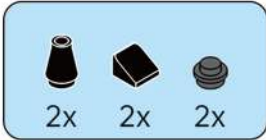

21

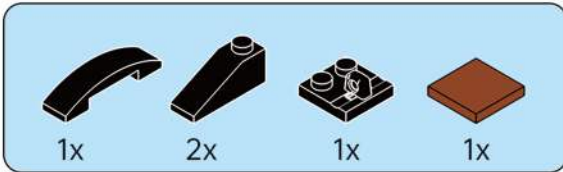
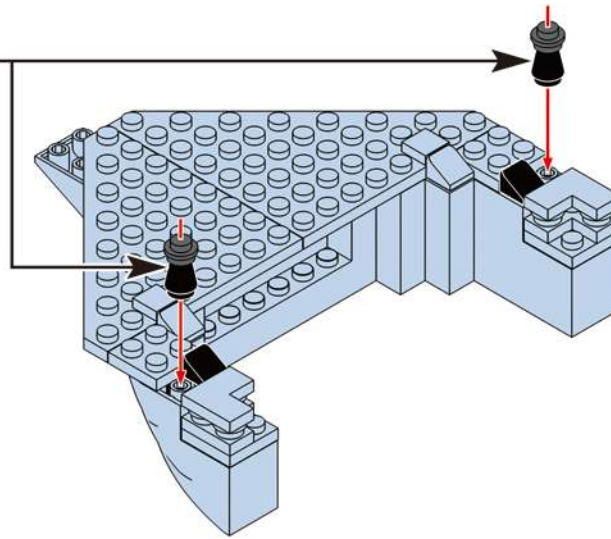
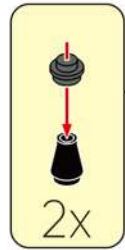

22

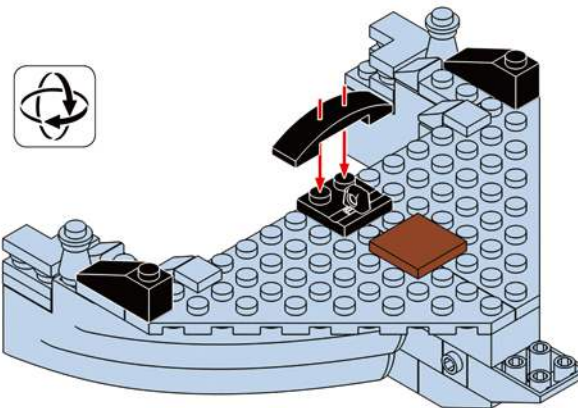

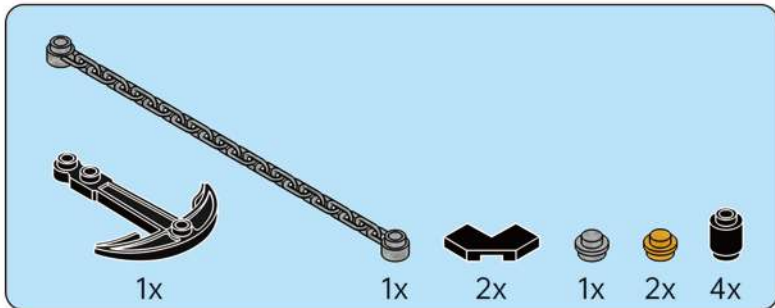

23

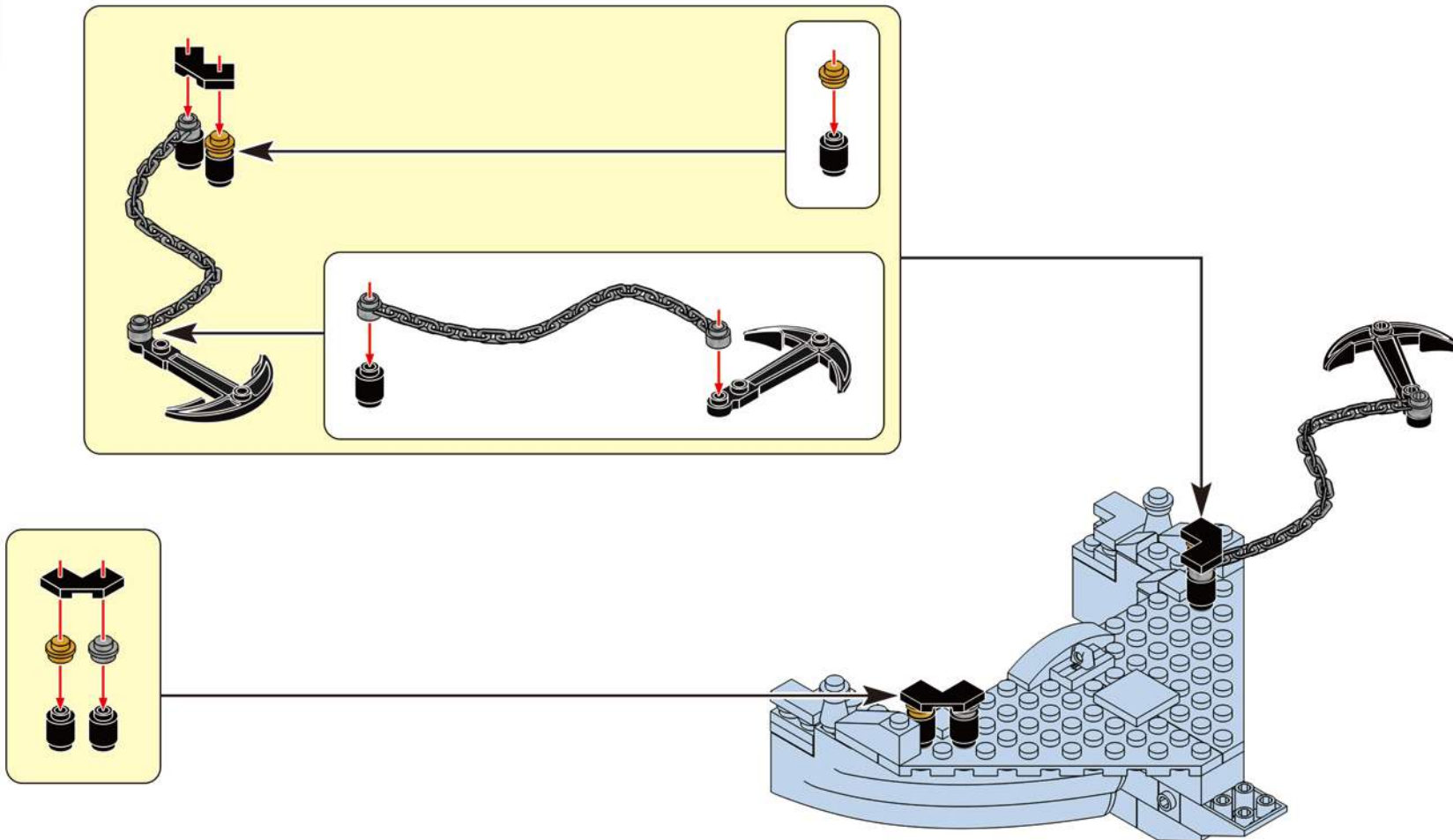

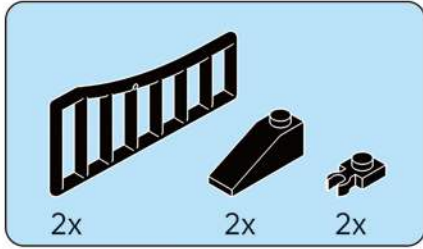

24

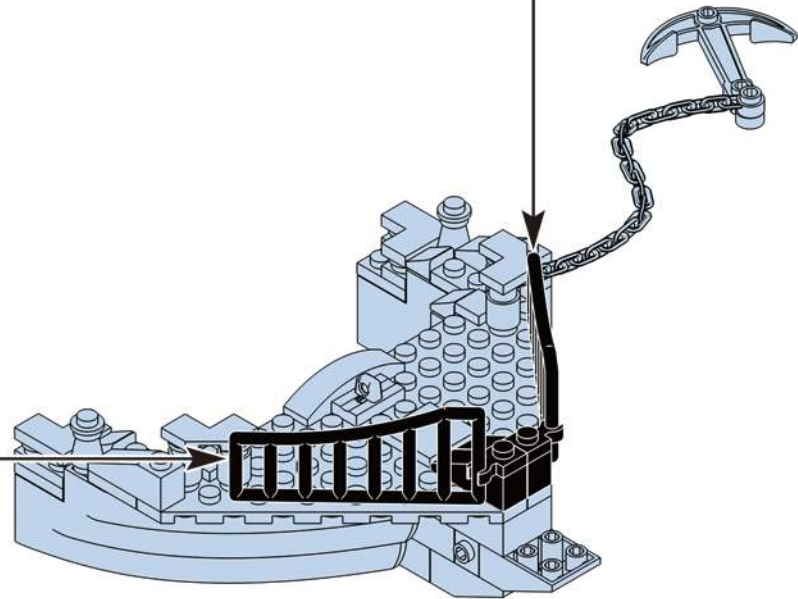
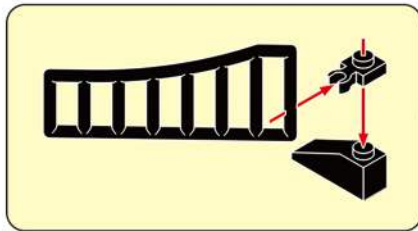
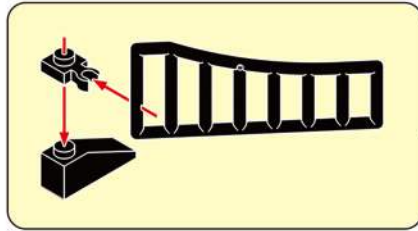

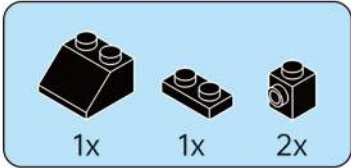

25

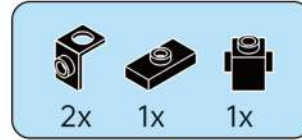
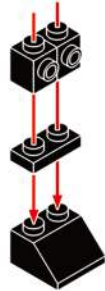

26

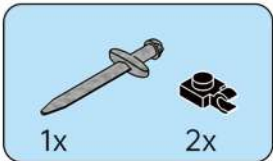
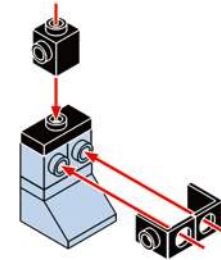

27

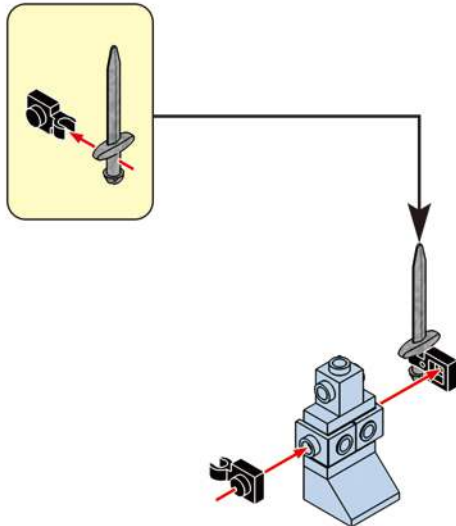

28

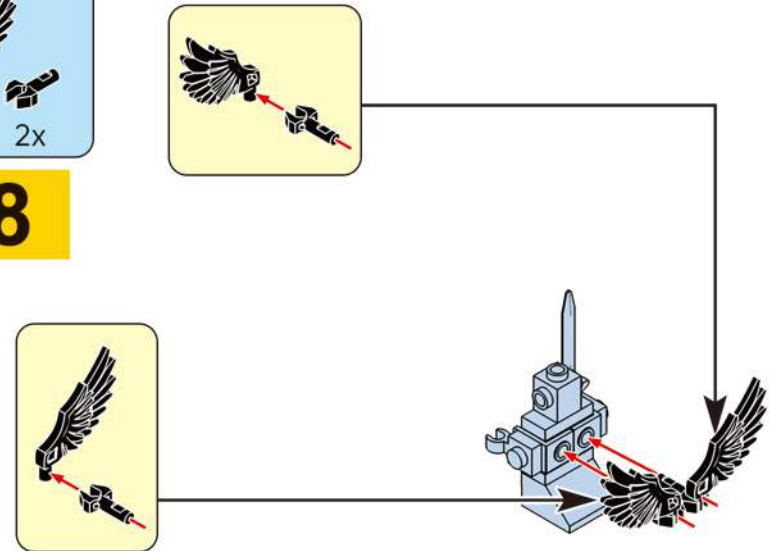

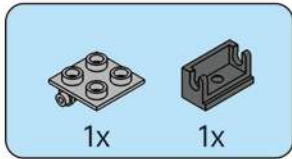

**29**

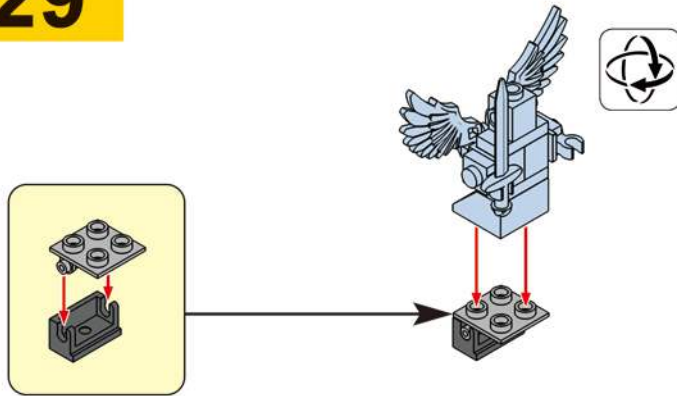

**30**

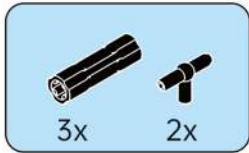
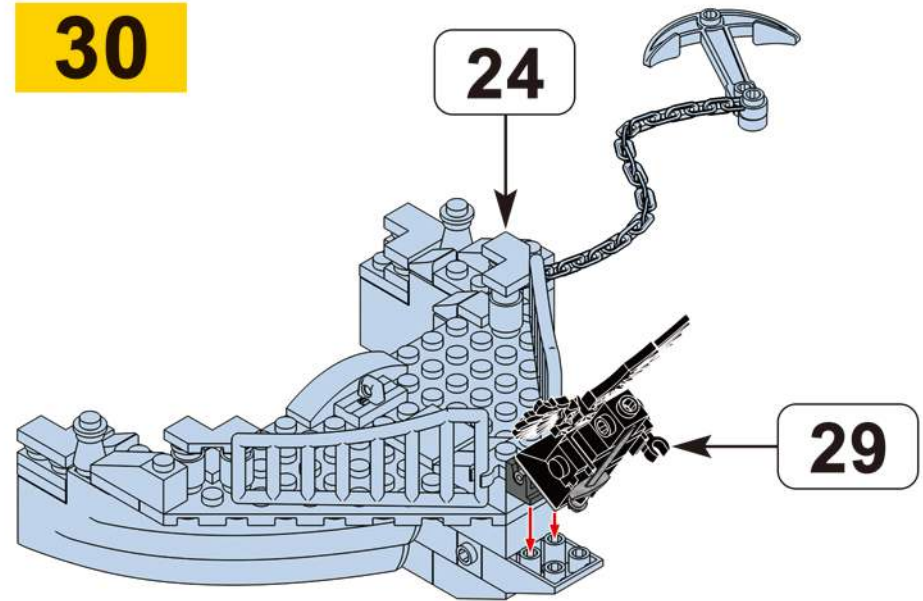

**31**

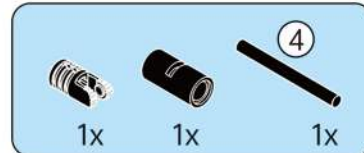
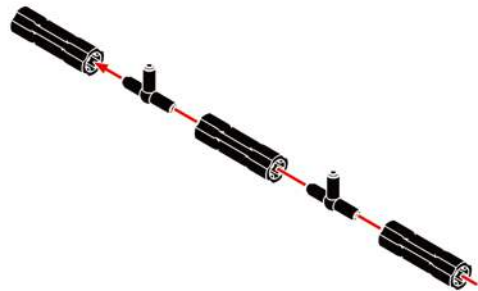

**32**

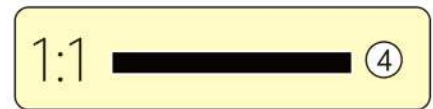
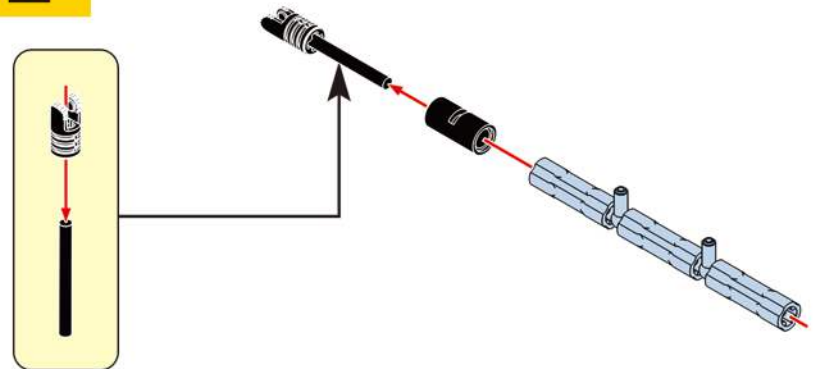

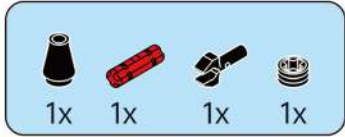

33

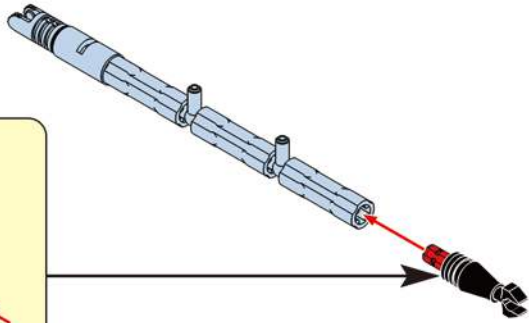
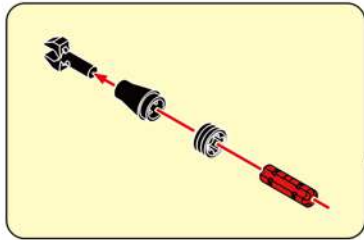

34

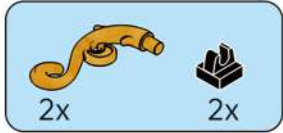
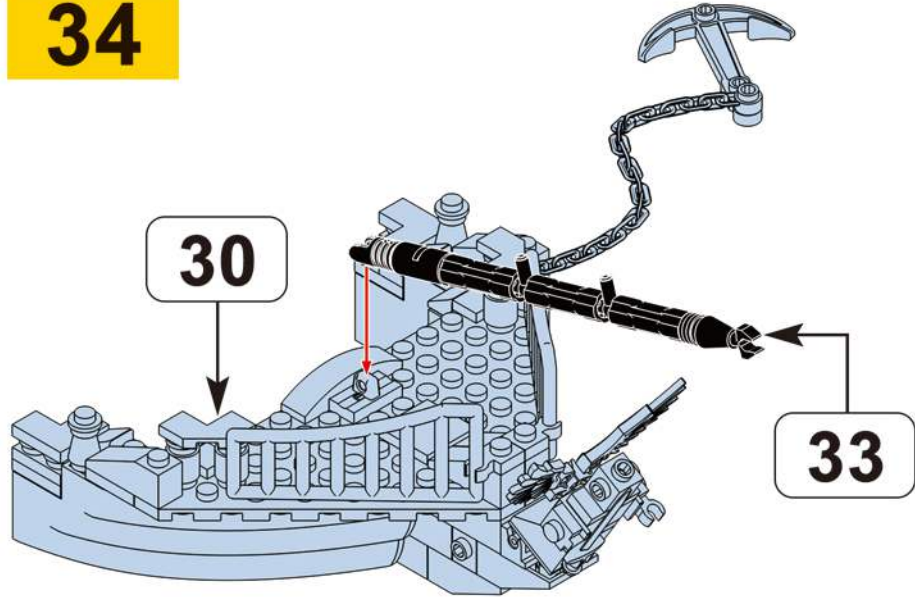



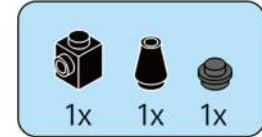
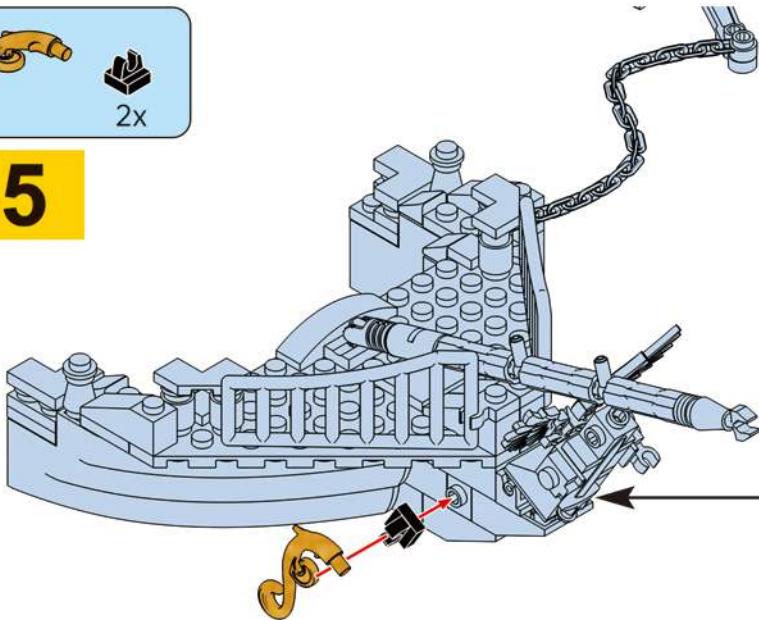

35

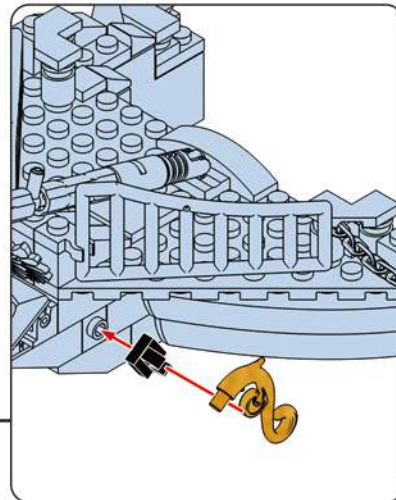

36



 **Yellow Gelb** 45cm/17.72in

1x  1x  1x 

37

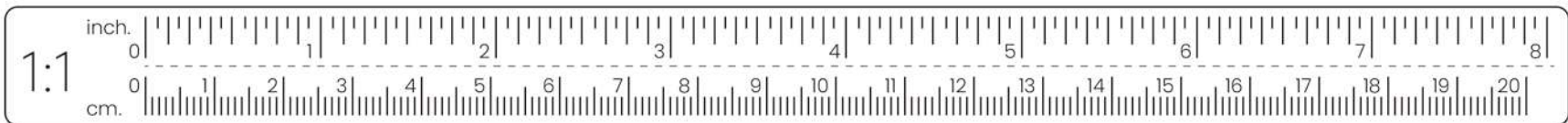
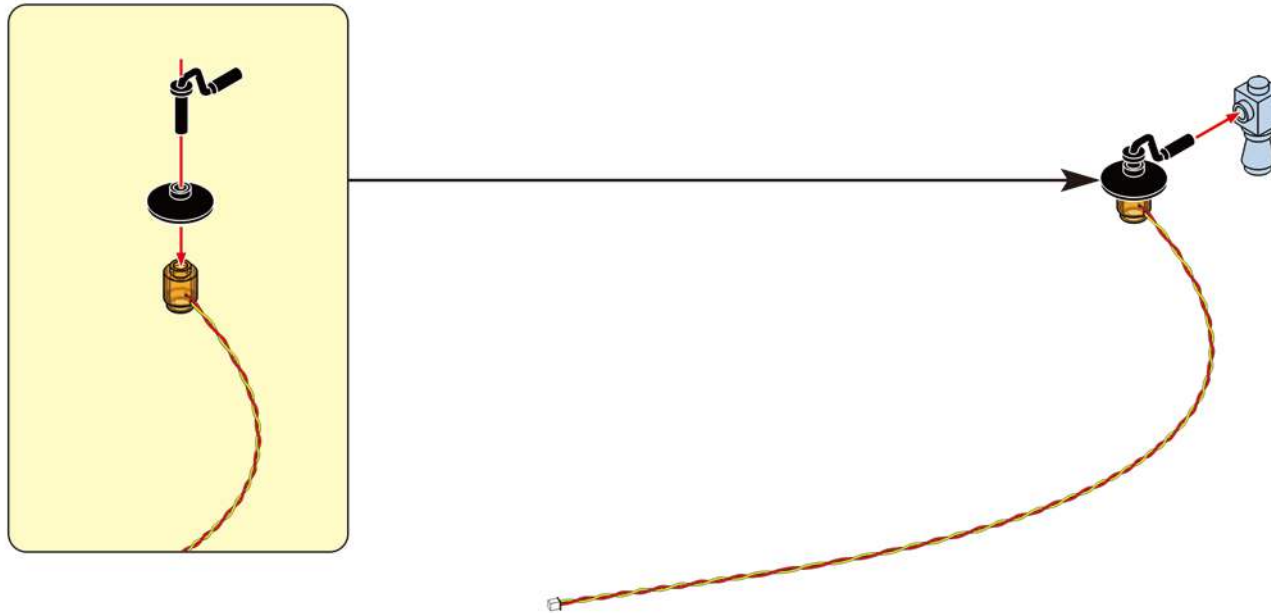

38

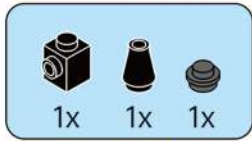
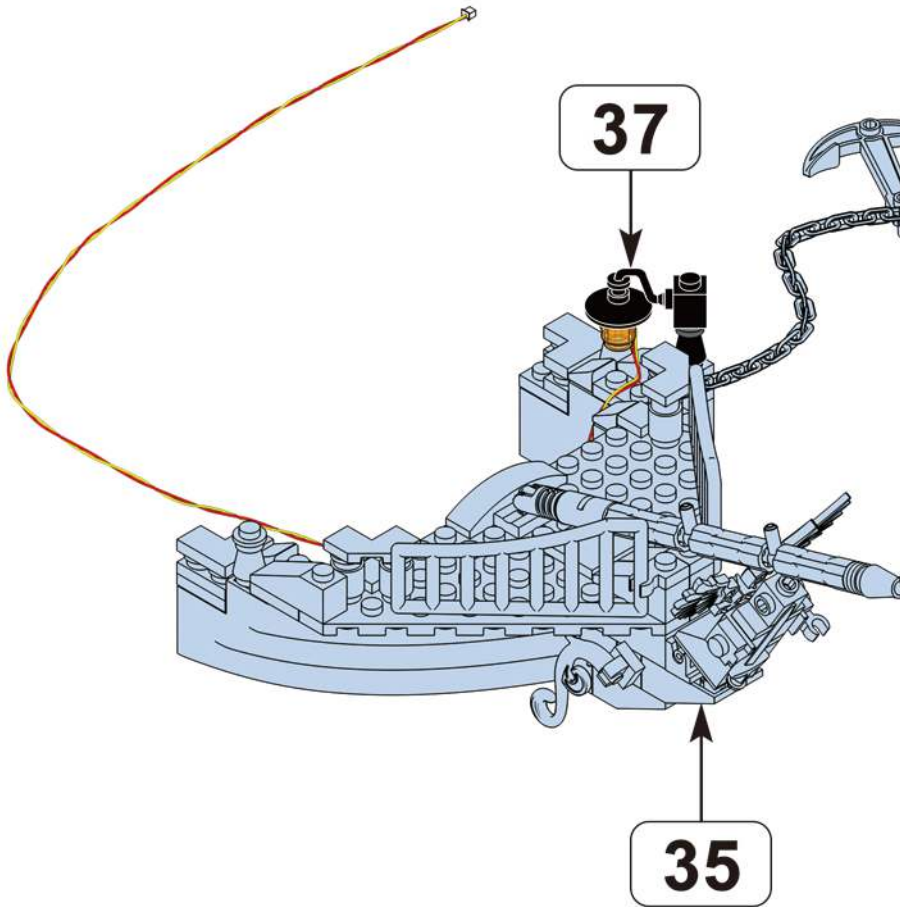

39



**JOY MAKES BRILLIANCE**

Yellow Gelb 45cm/17.72in

1x

1x 1x

40

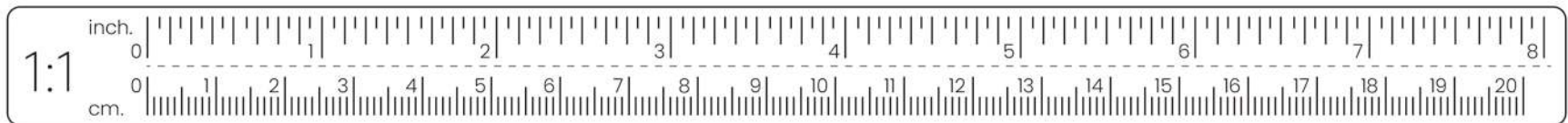
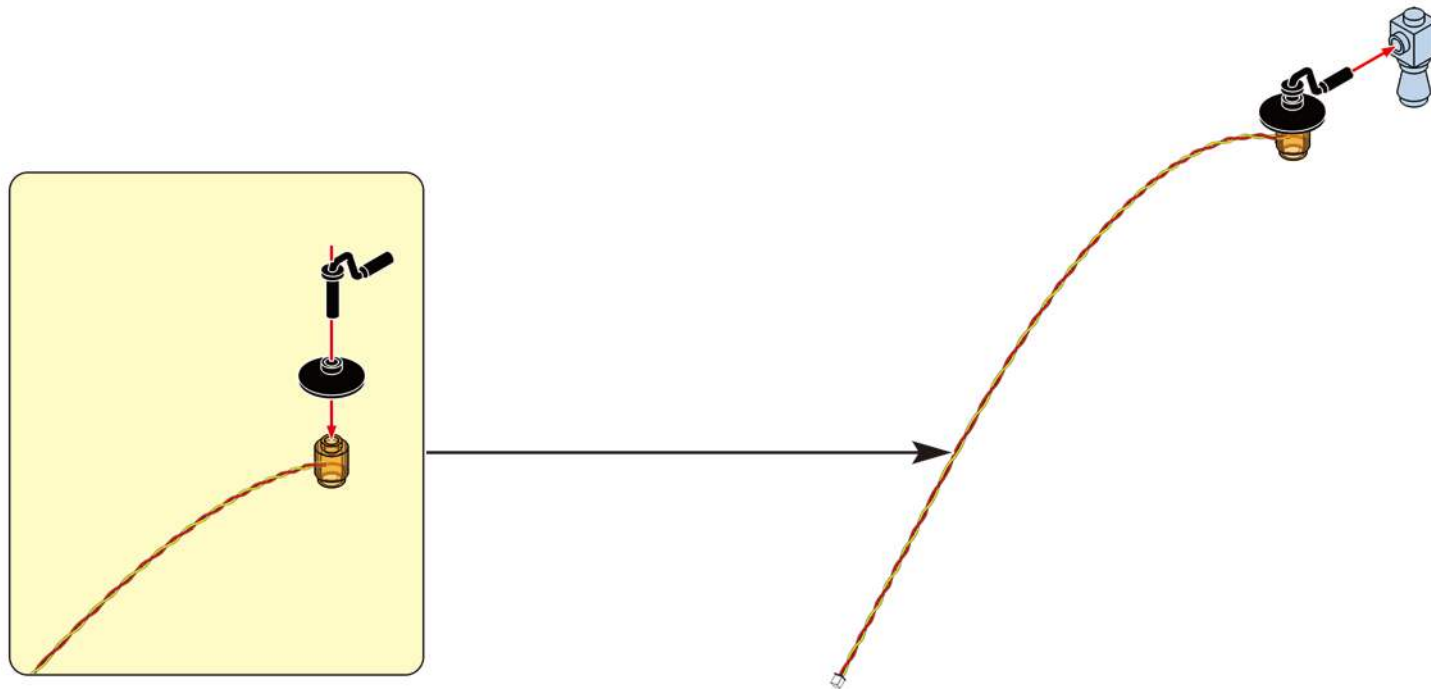

41

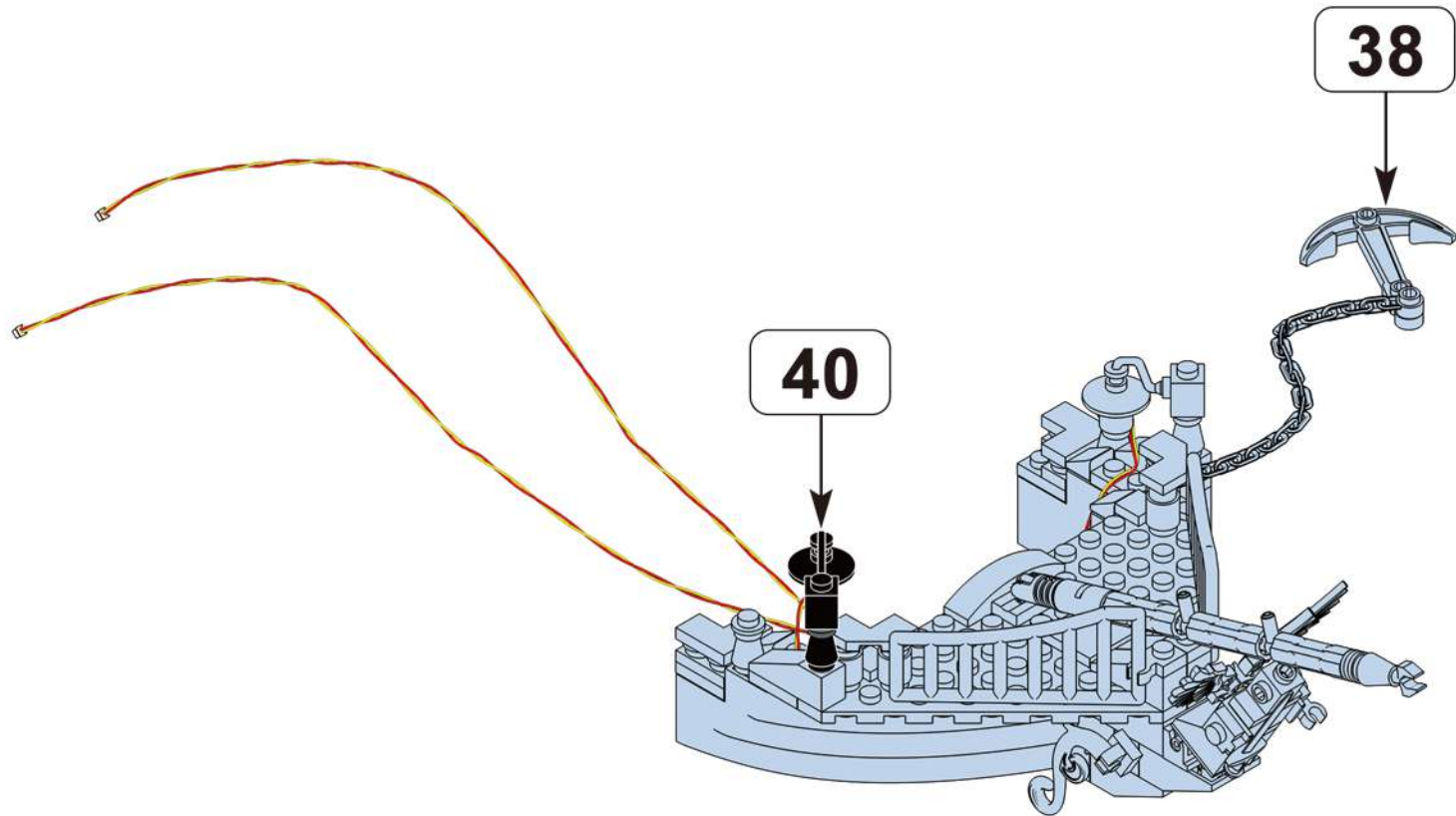

42

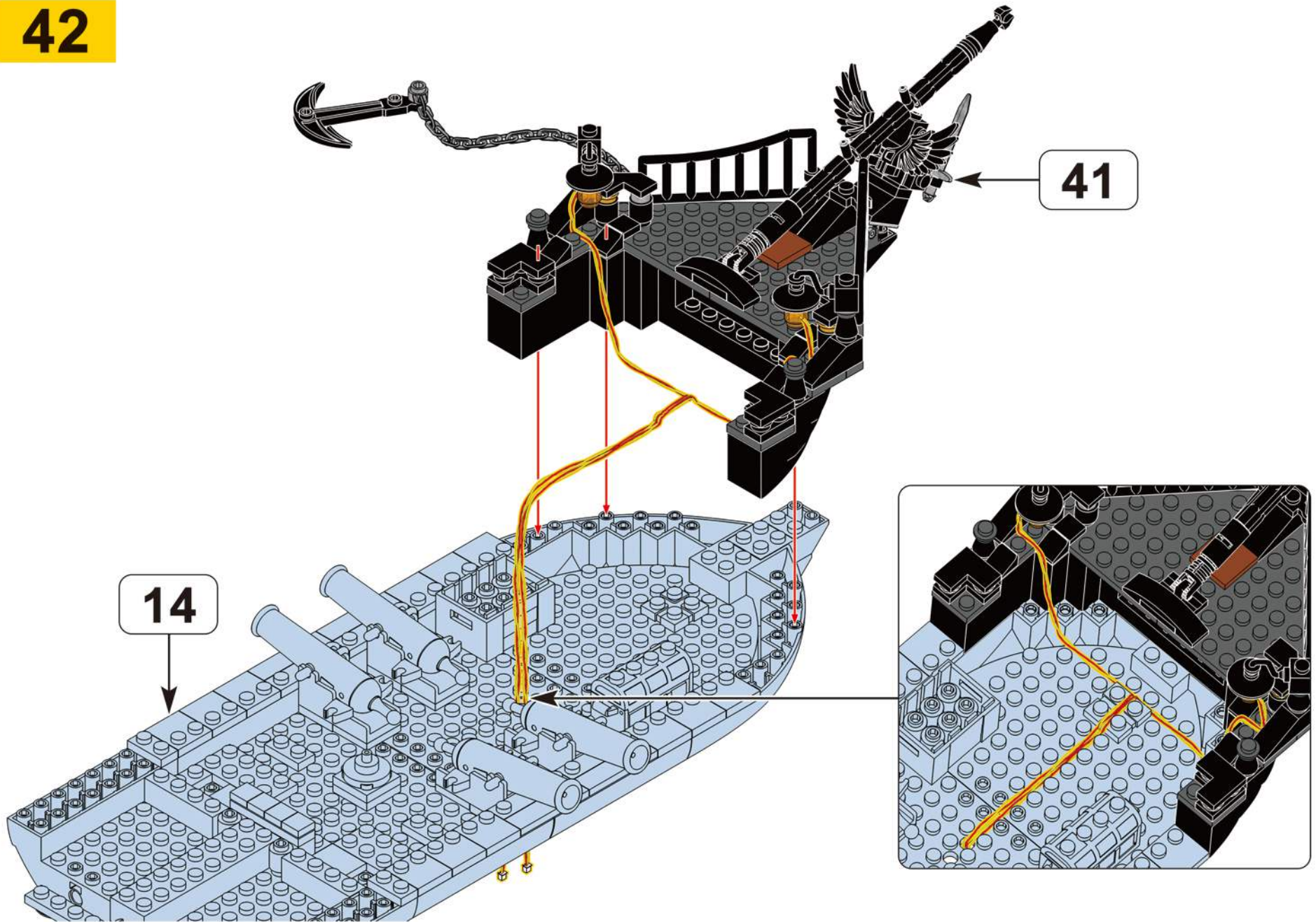

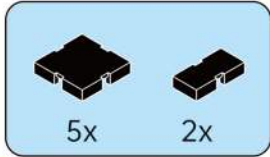

**43**

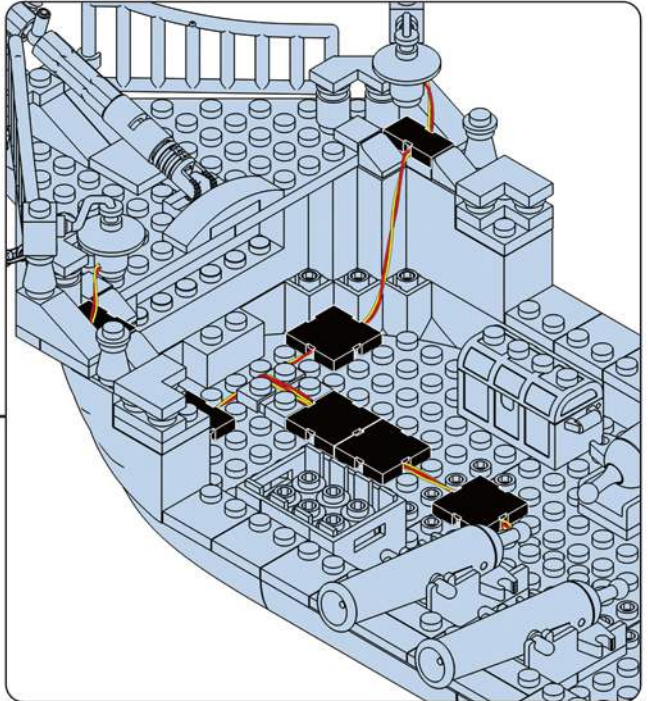
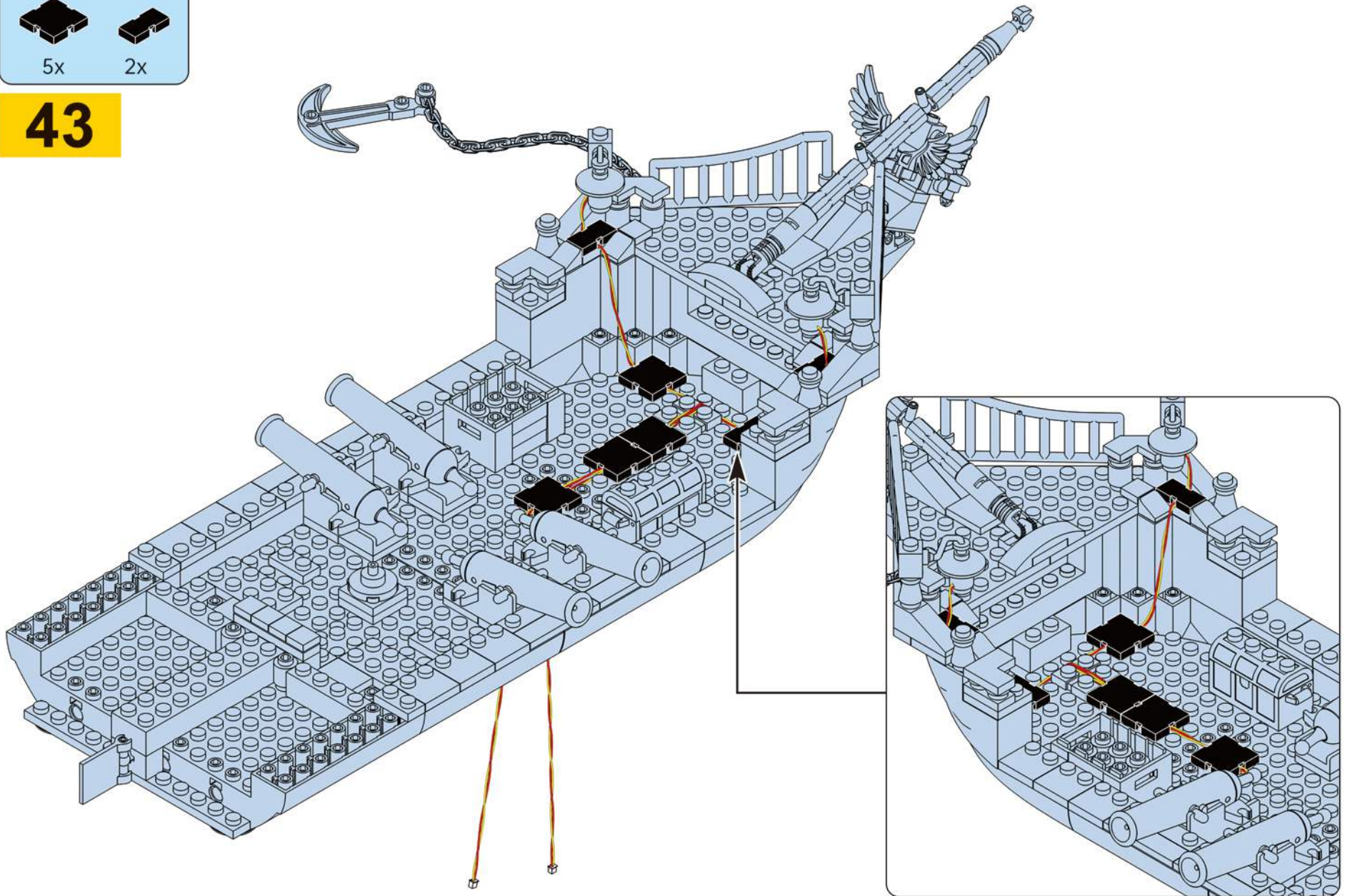

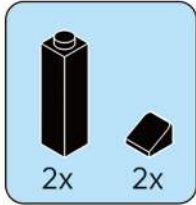

44

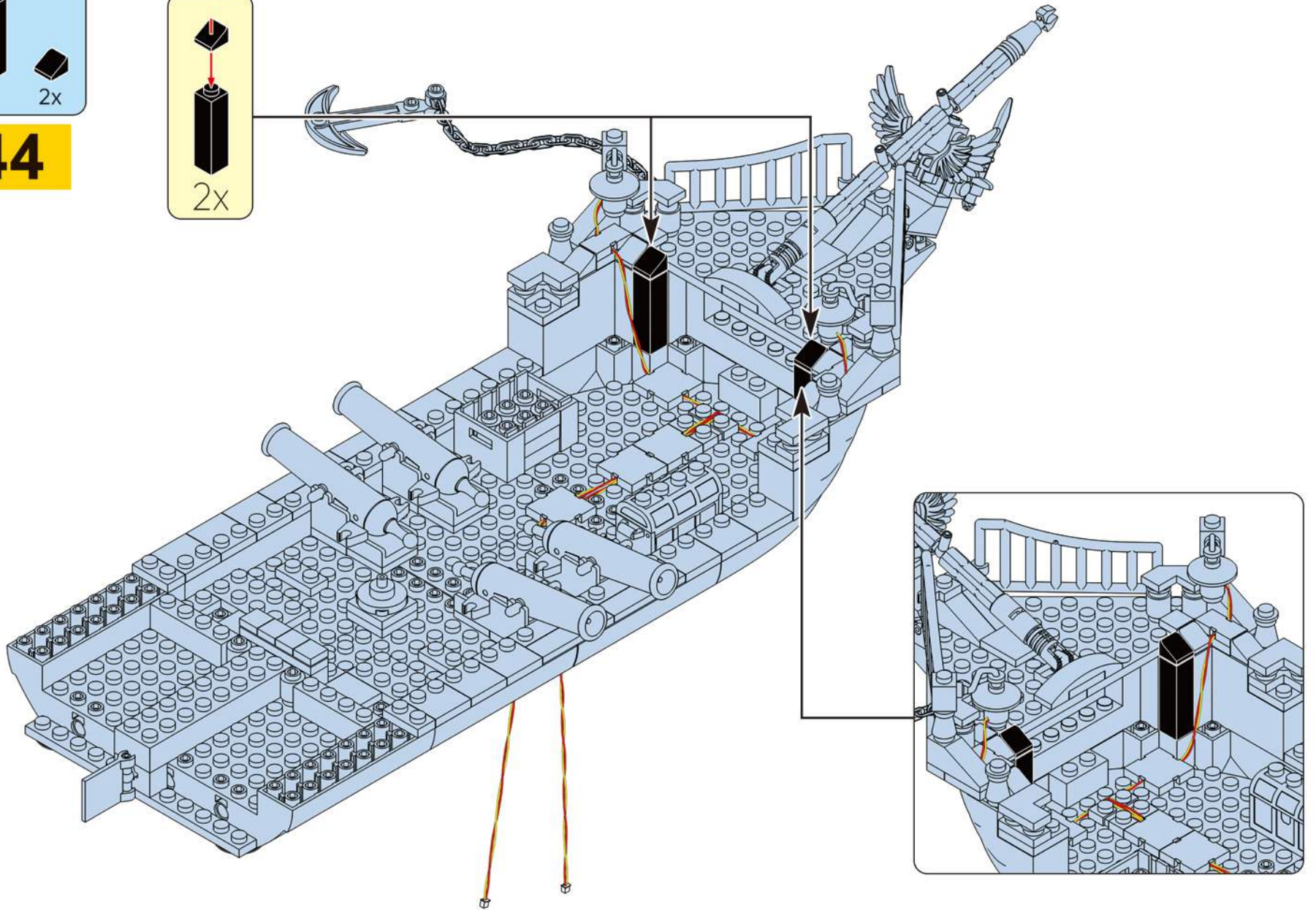
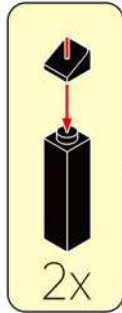

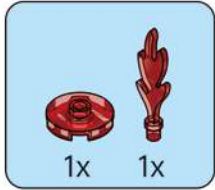

45

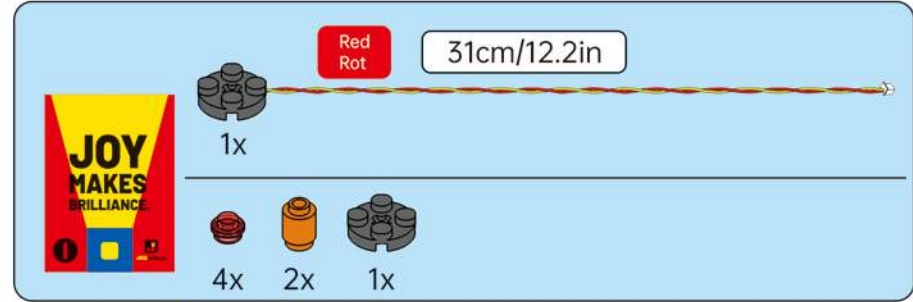

46

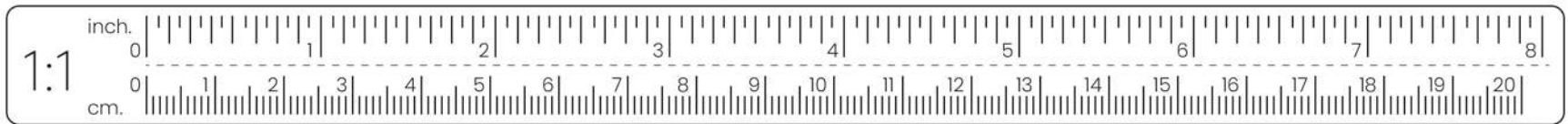
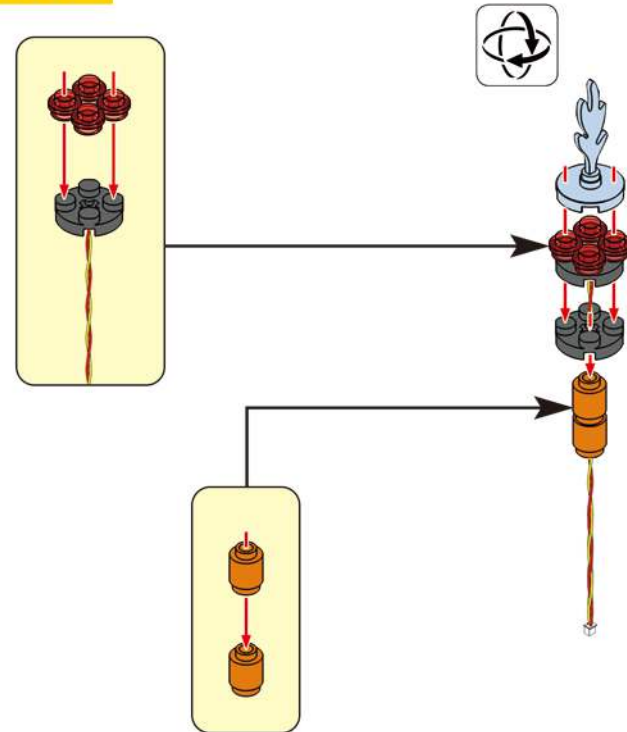

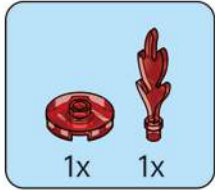

**47**

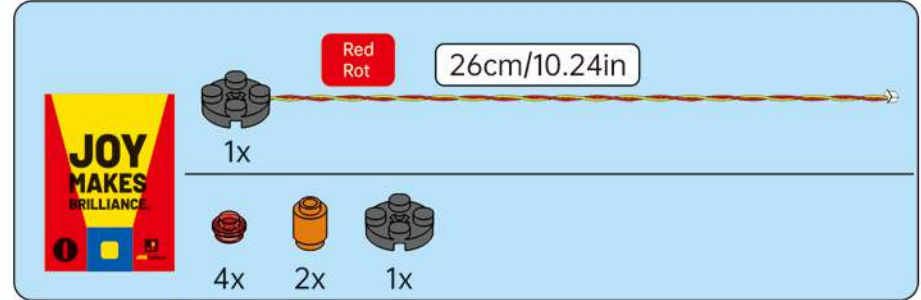

**48**

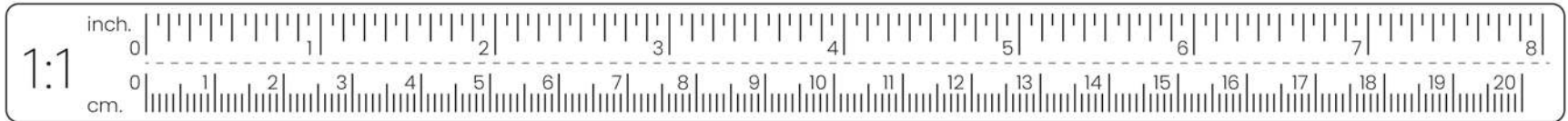
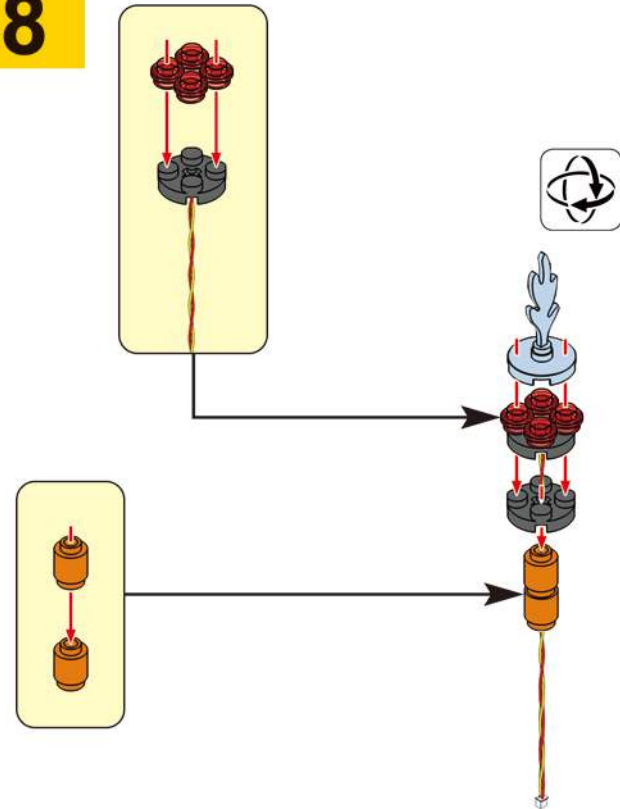

49

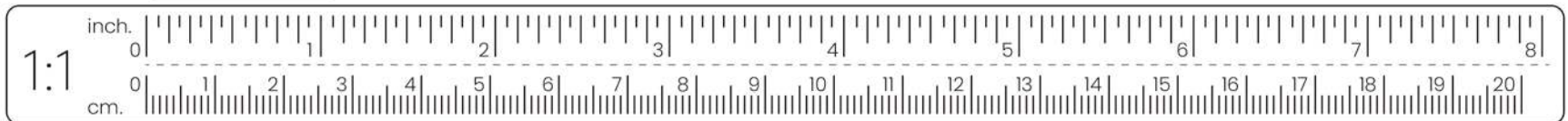
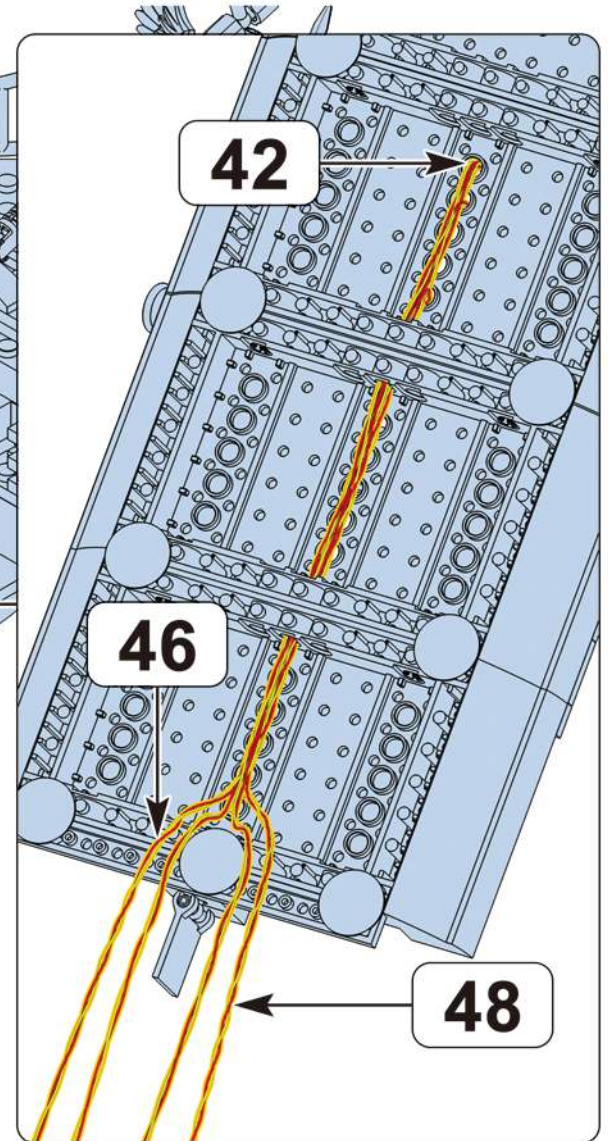
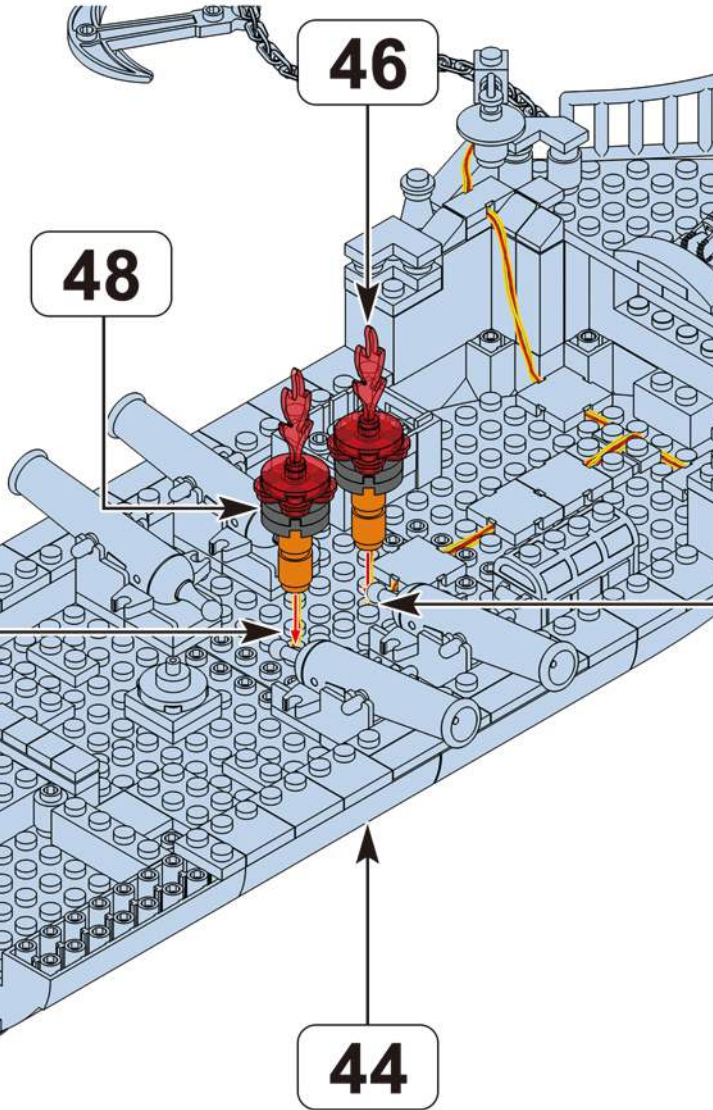
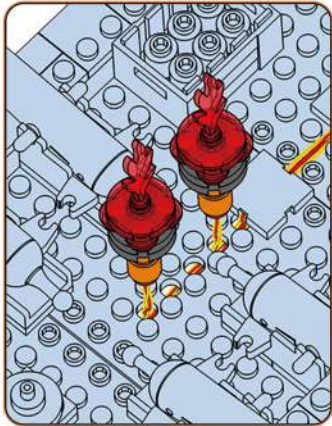



50

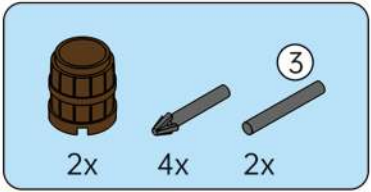
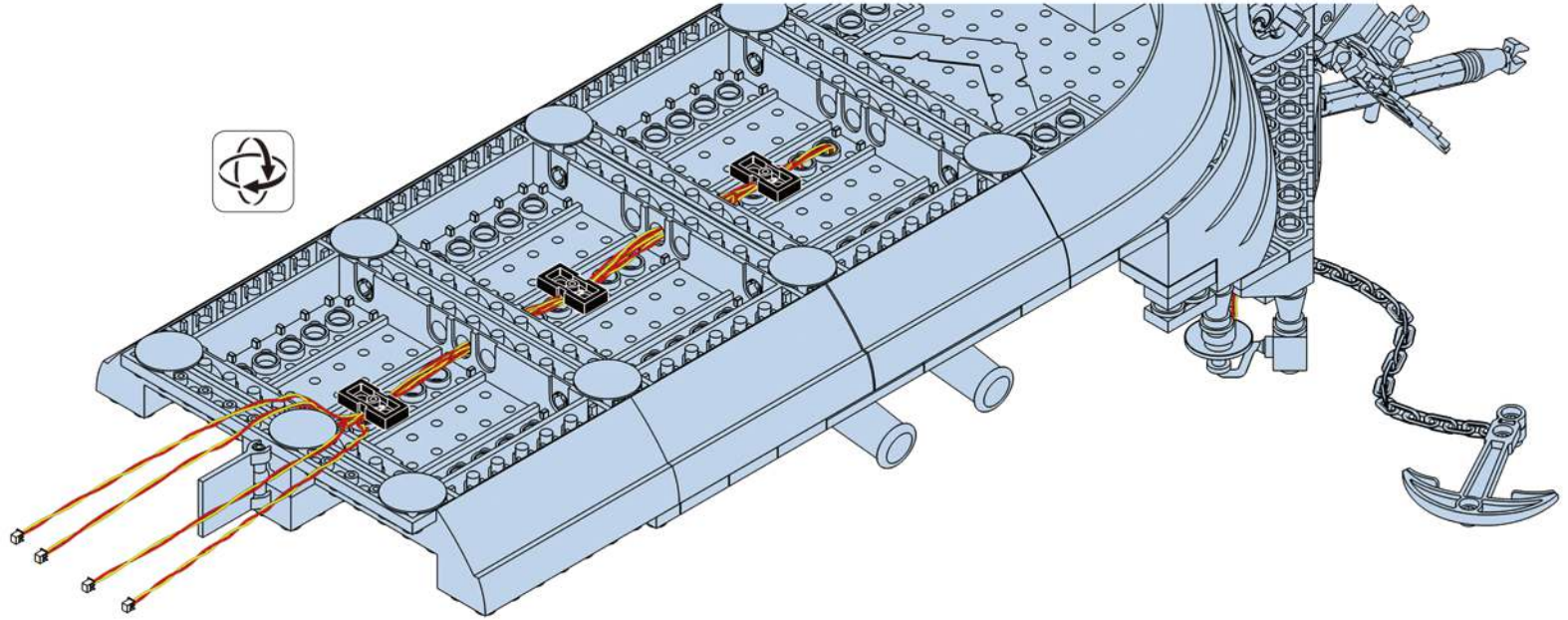

51

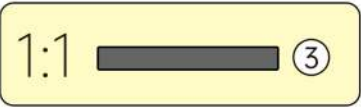
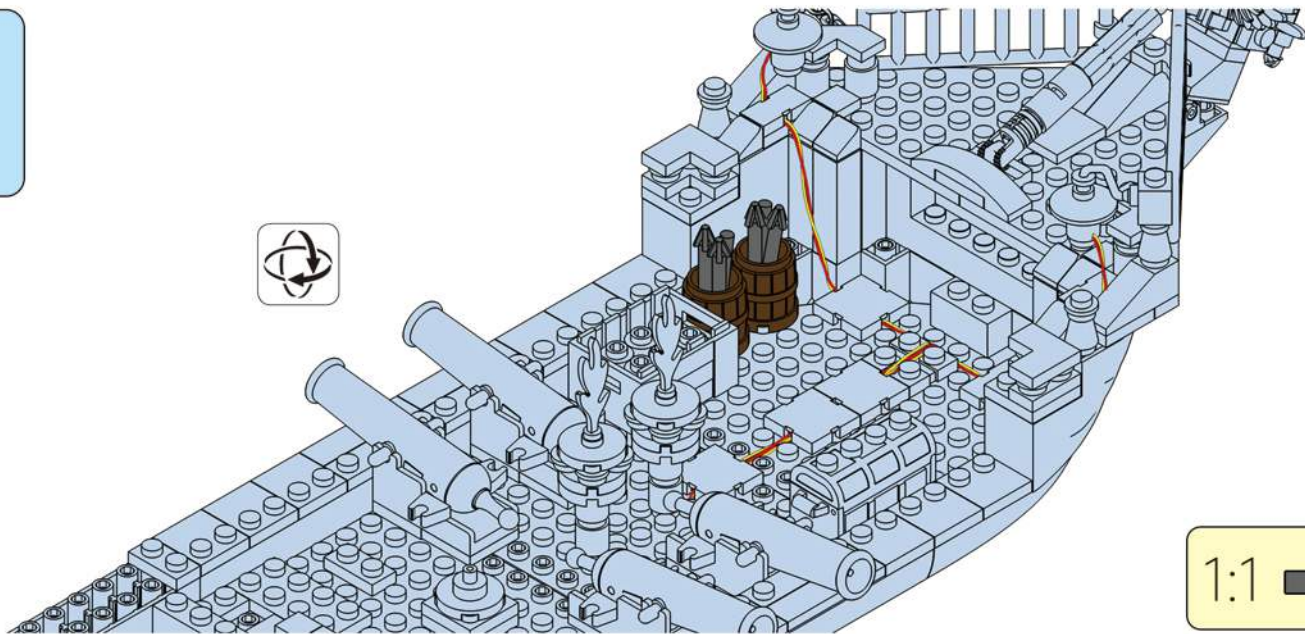

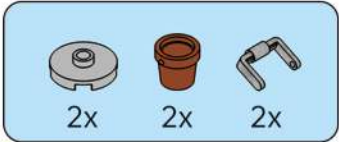

**52**

- 1
  - 2
- 2x

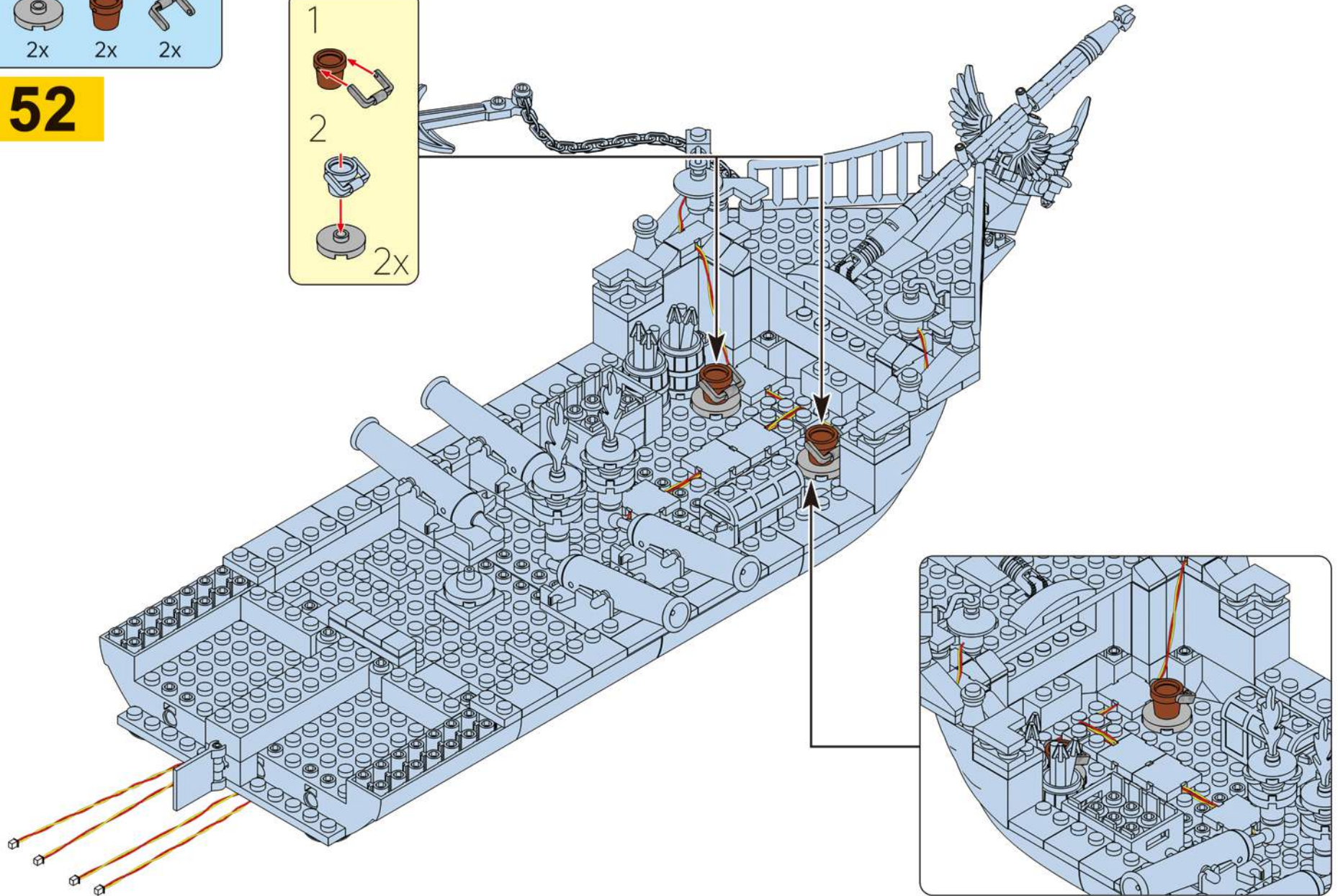

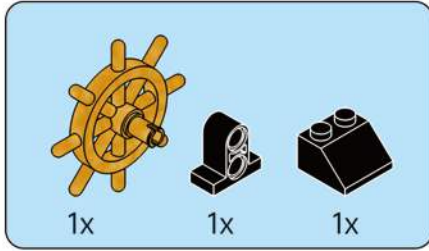

53

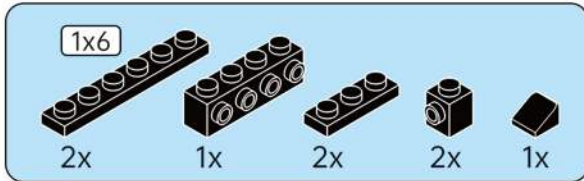
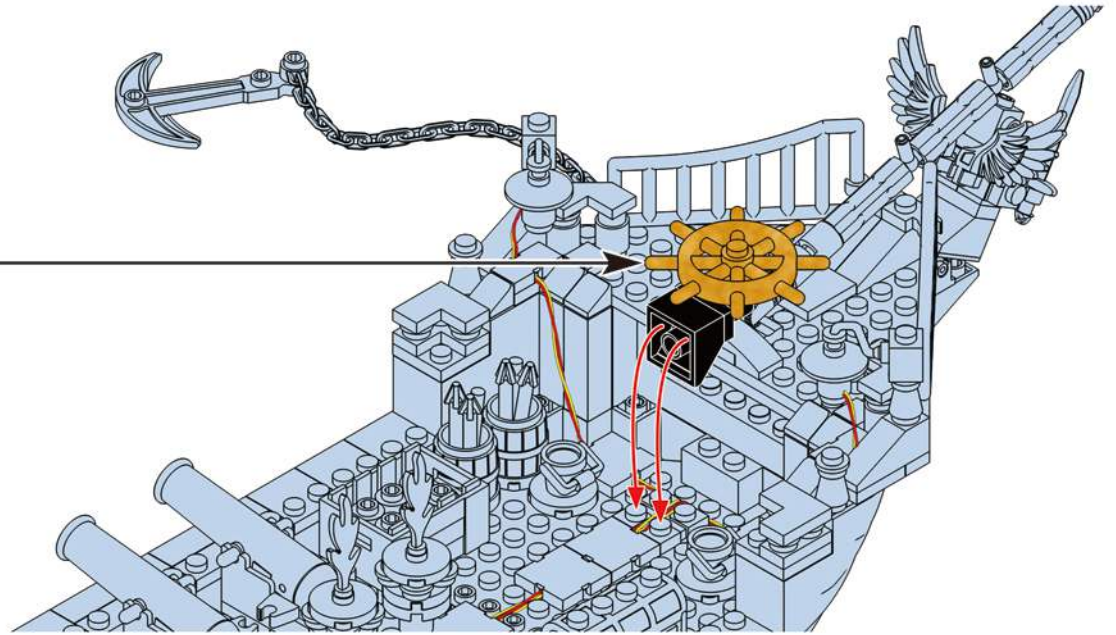
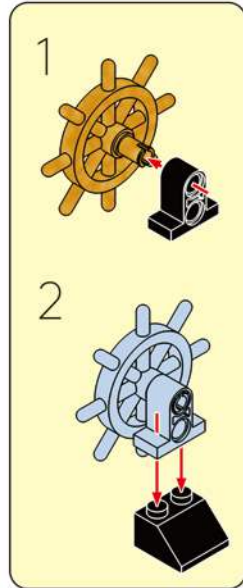

54

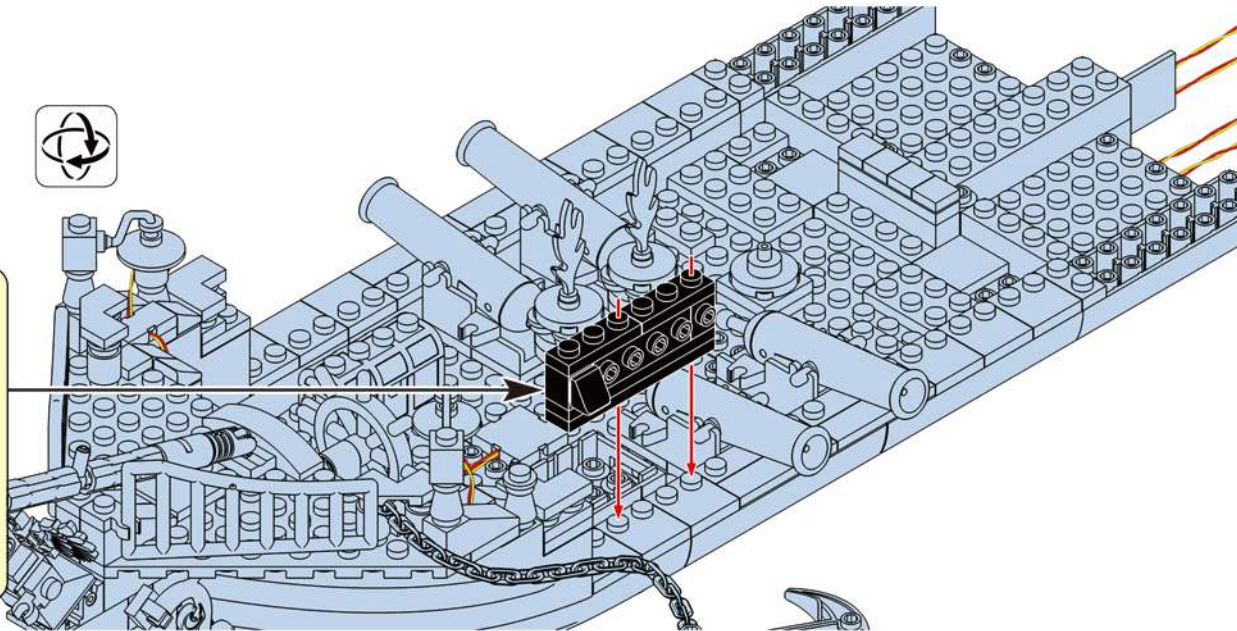
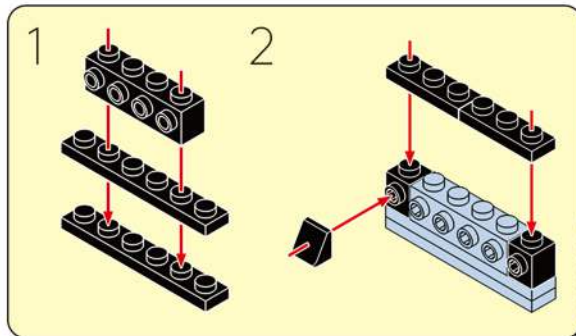

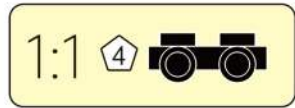
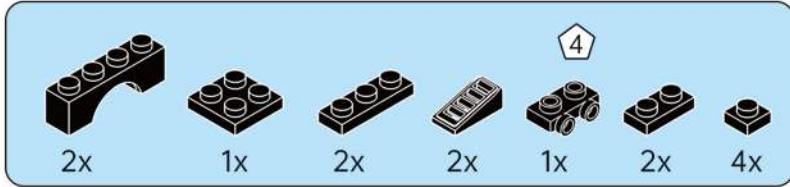

# 55

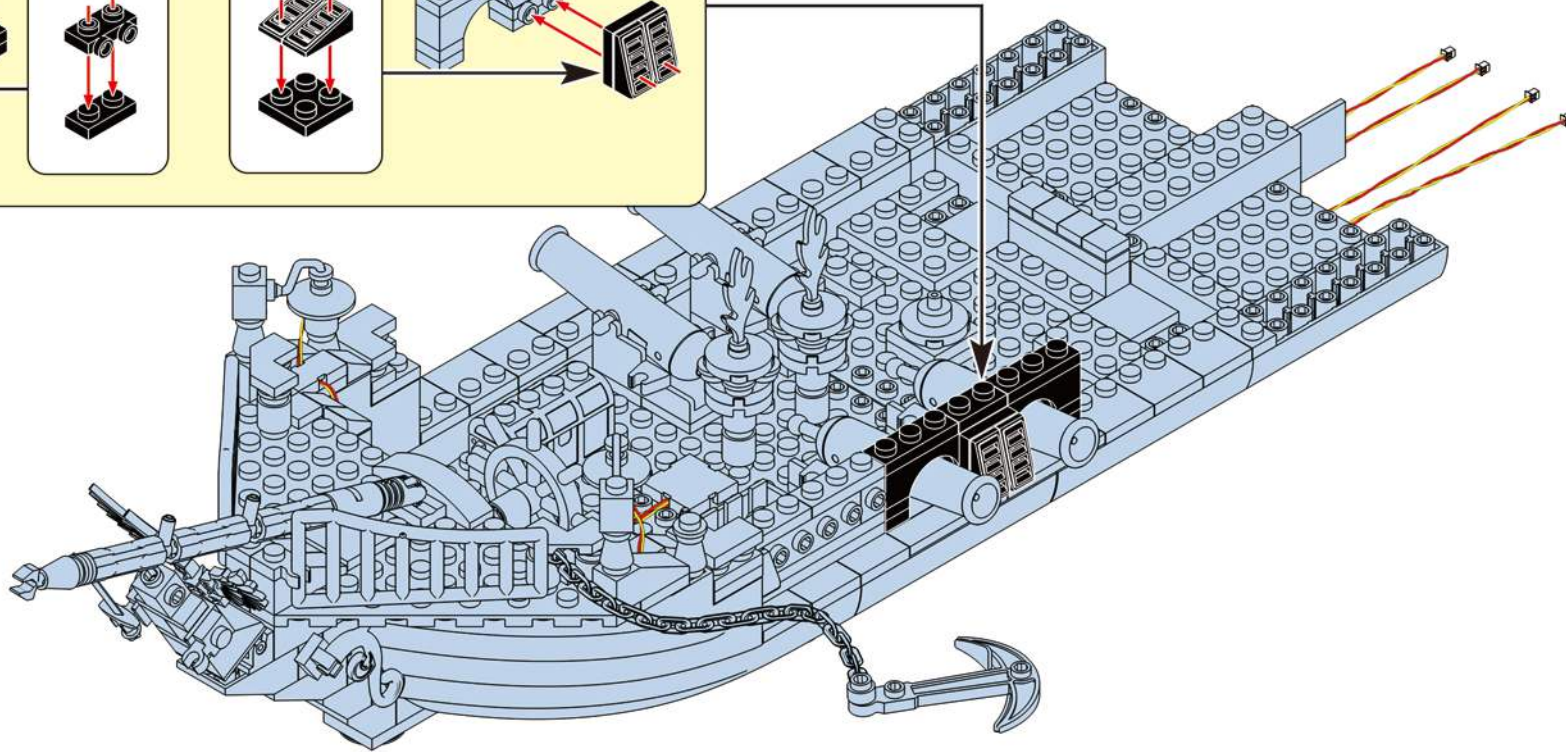
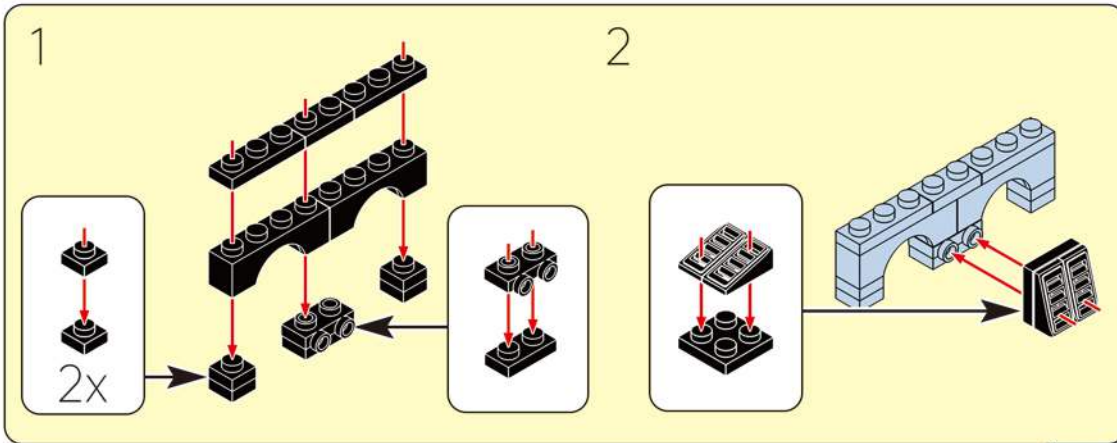

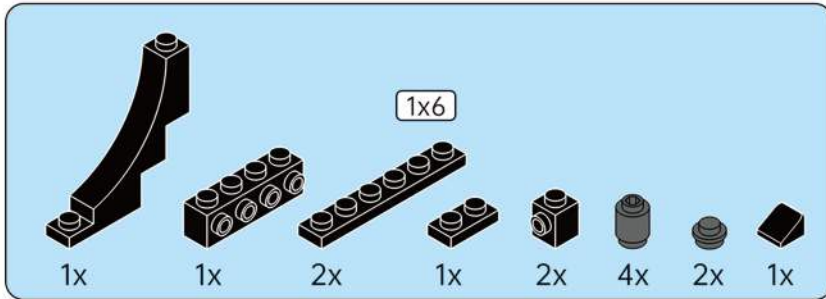

56

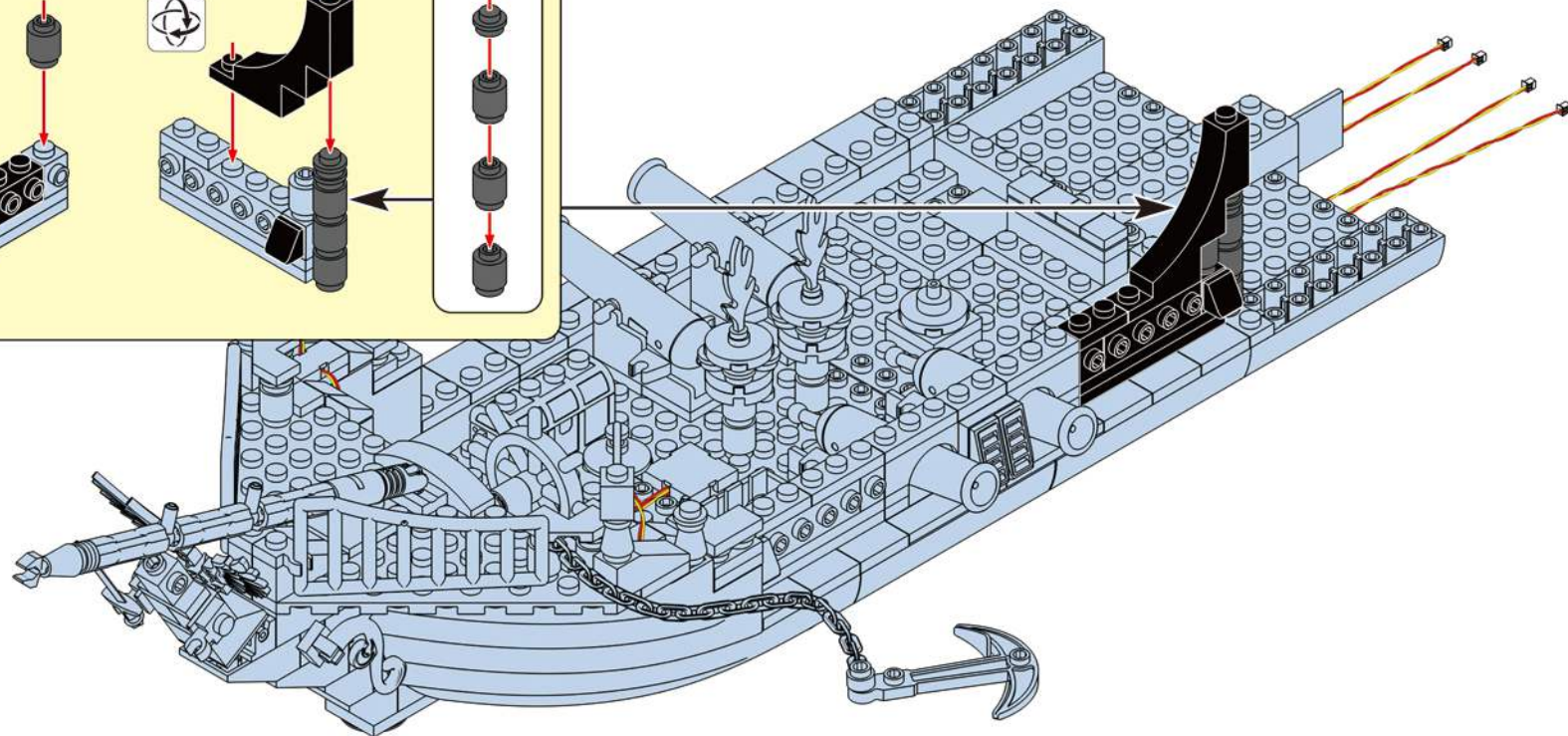
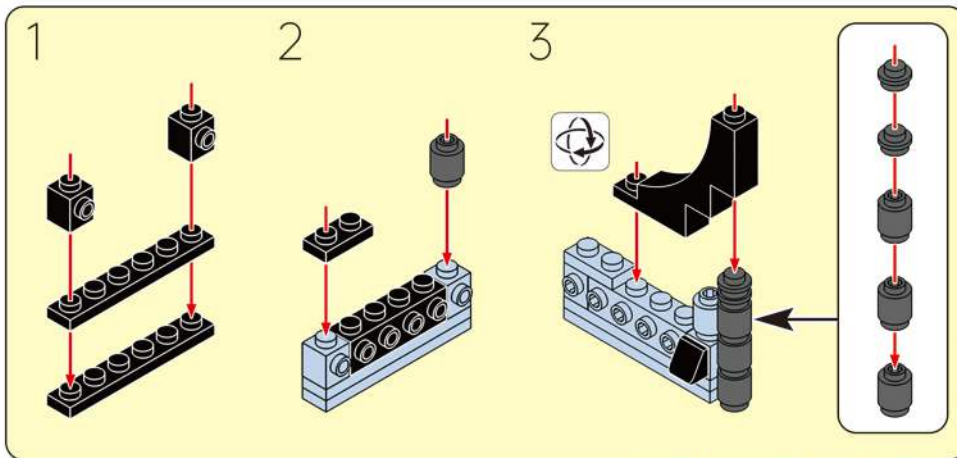

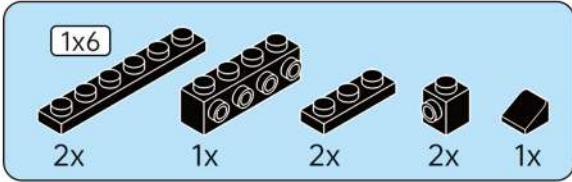

# 57

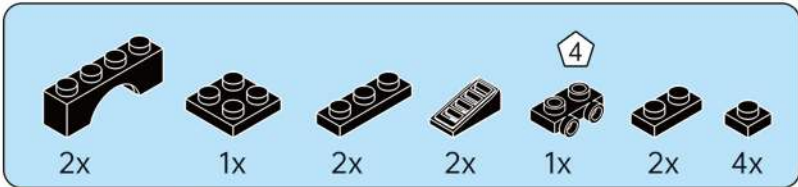
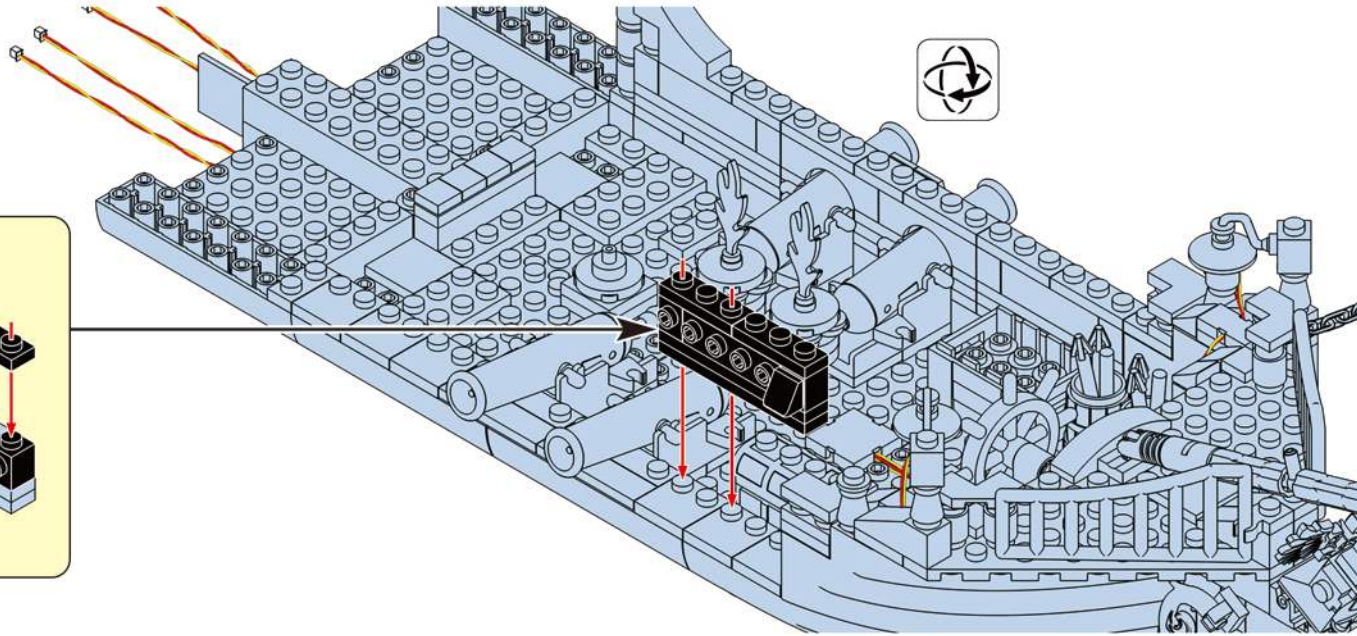
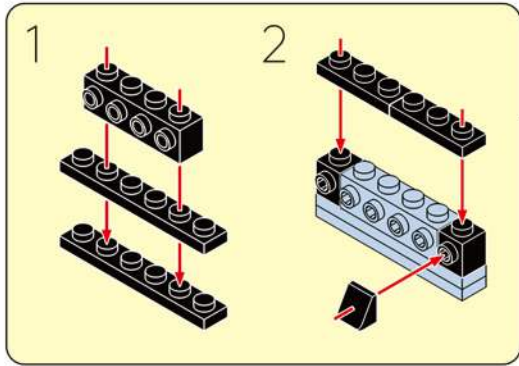

# 58

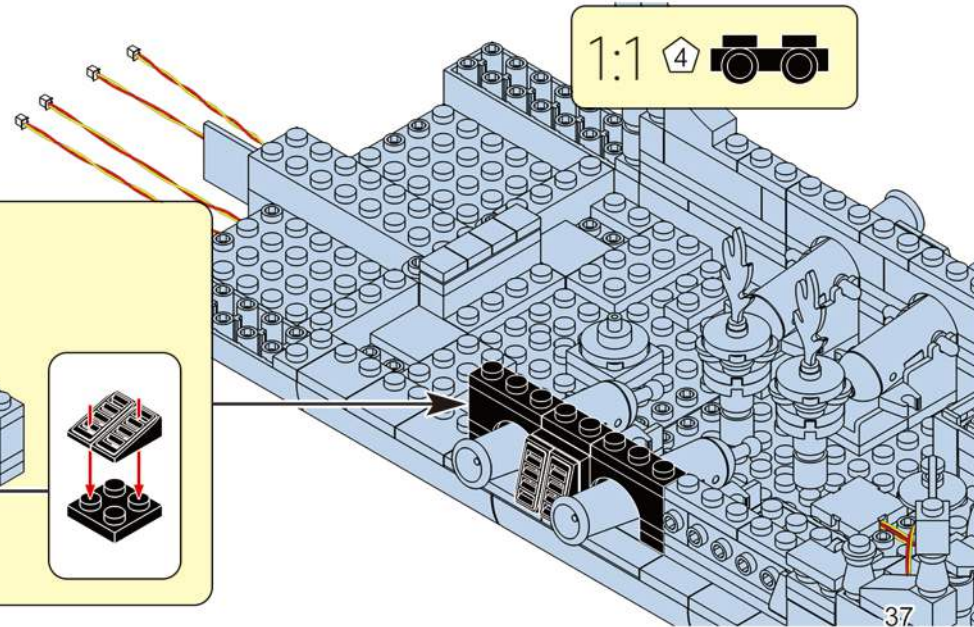
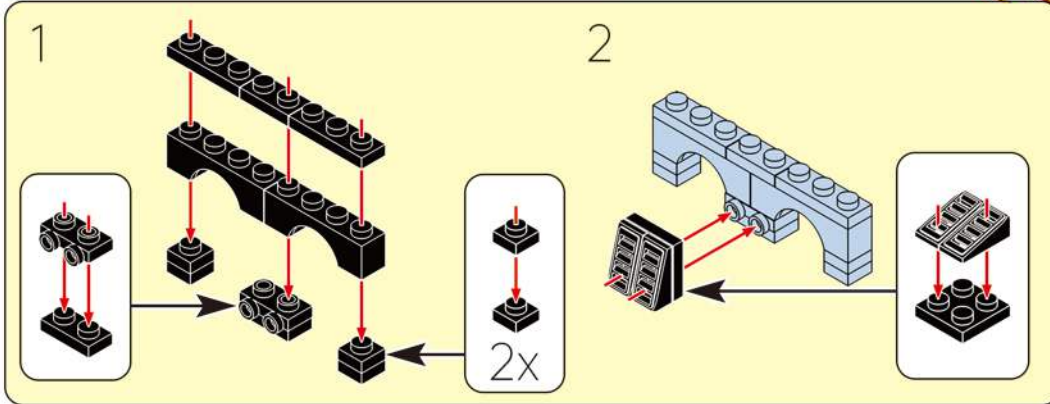

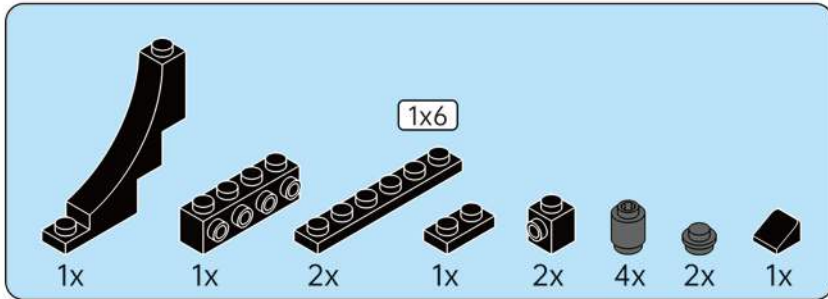

59

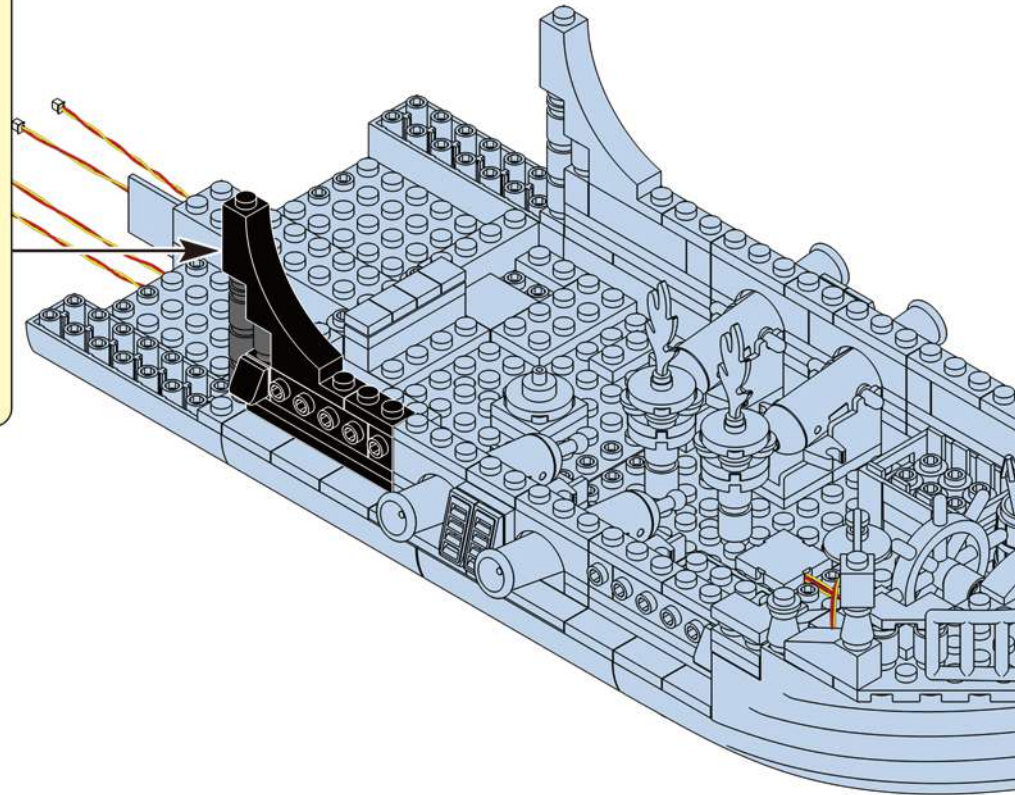
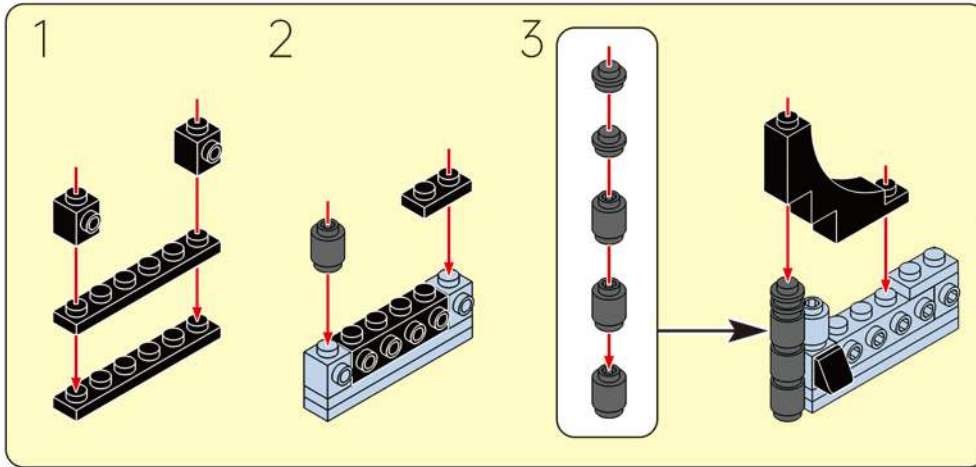

# JOY MAKES BRILLIANCE.

## Embrace Relaxation Embrace Joy

Every adultescent needs a "JOY BOX".  
Please , open your JOY BOX ! Heading for joy.

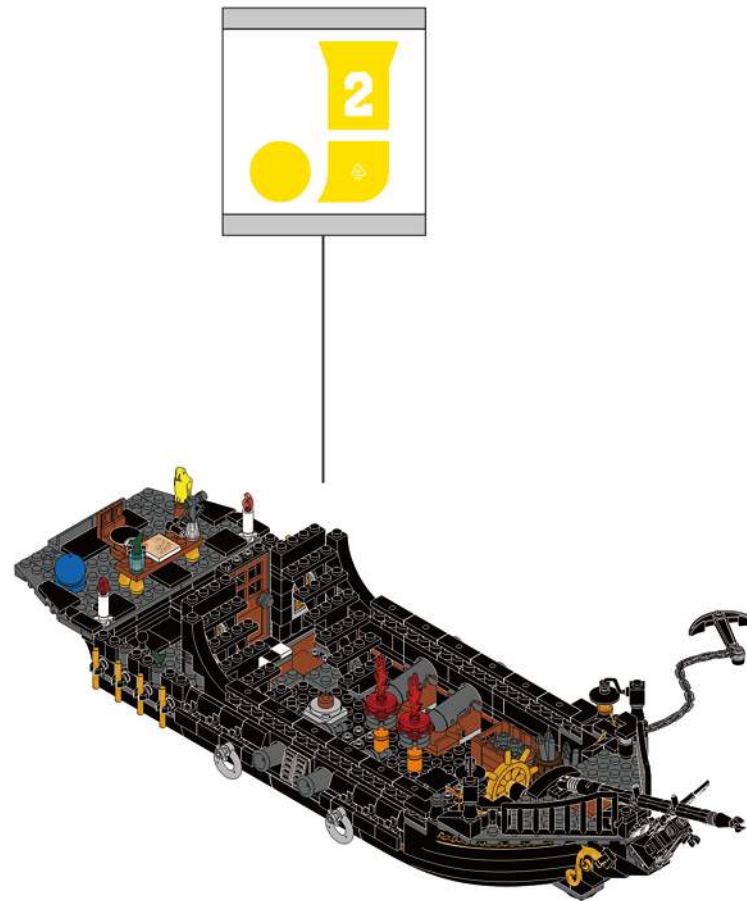

6x

60

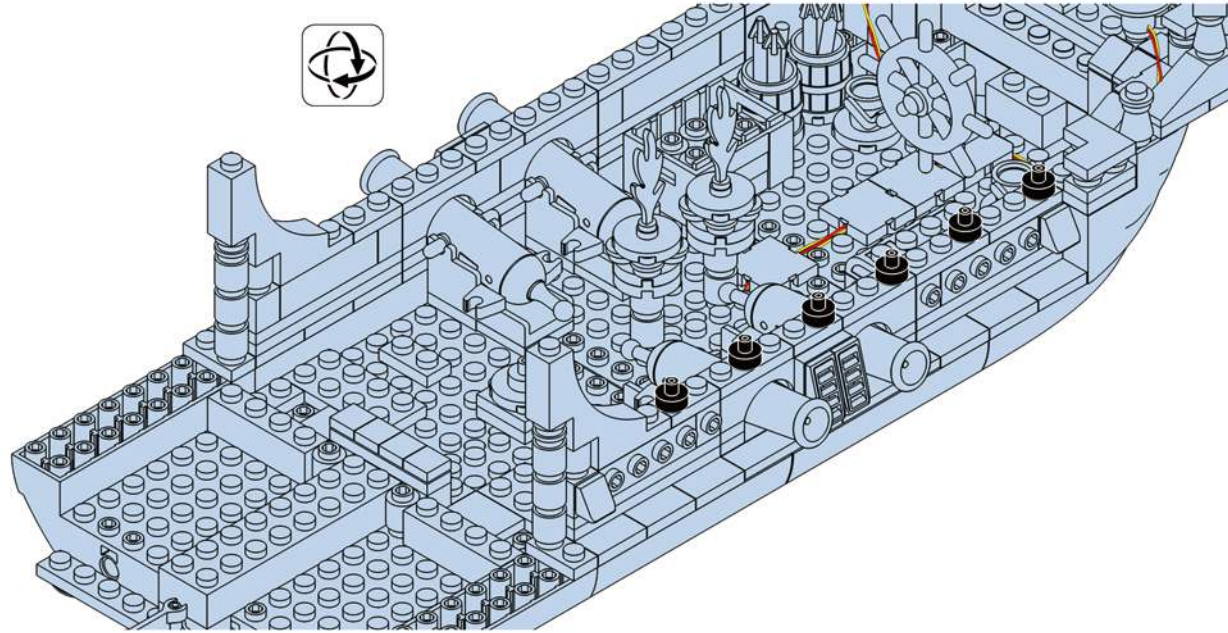

6x 12x

61

6x

An inset diagram for step 61. It shows a 1x6 Technic beam with two pins being inserted into the second and third holes from the left. Red arrows indicate the direction of insertion. The number '6x' is written below the beam, indicating that six of these assemblies are required.

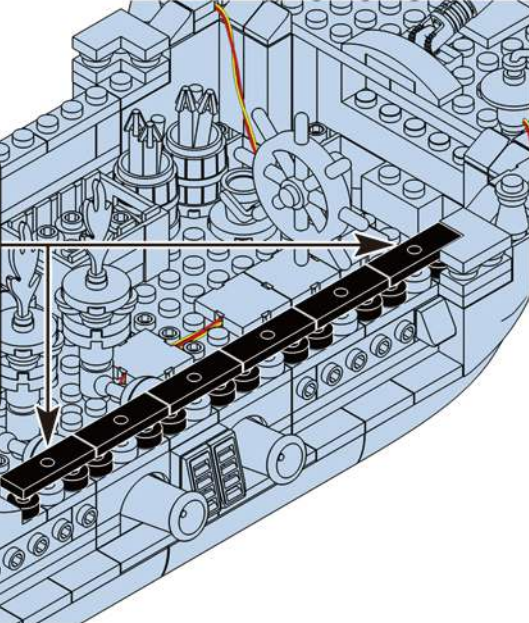

6x

62

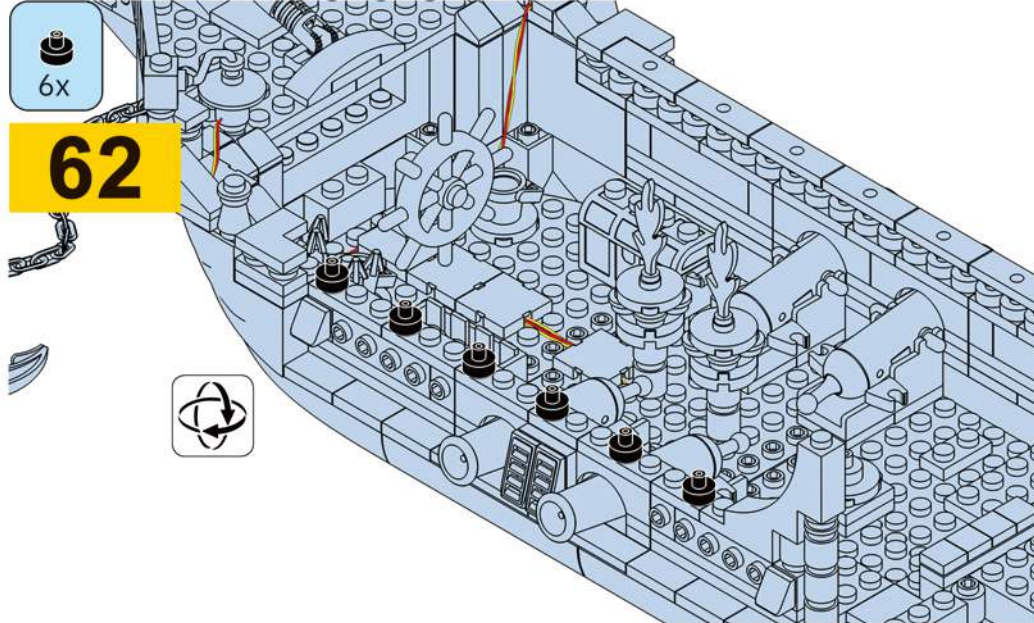

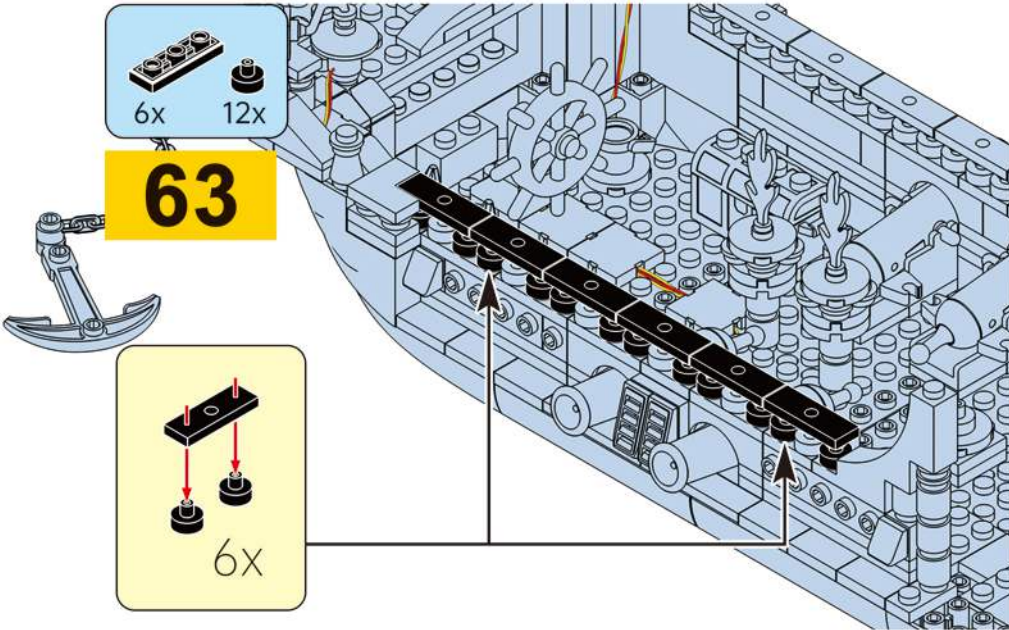

64

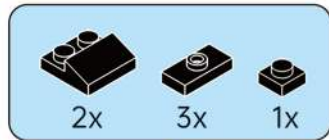
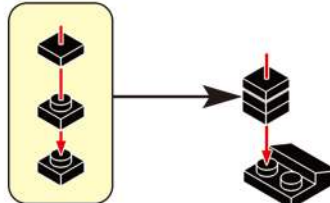

65

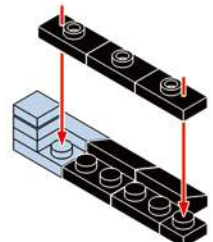

66

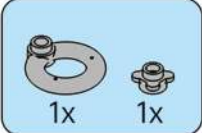
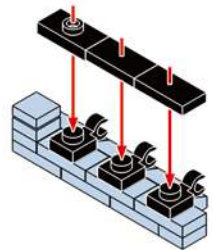

67

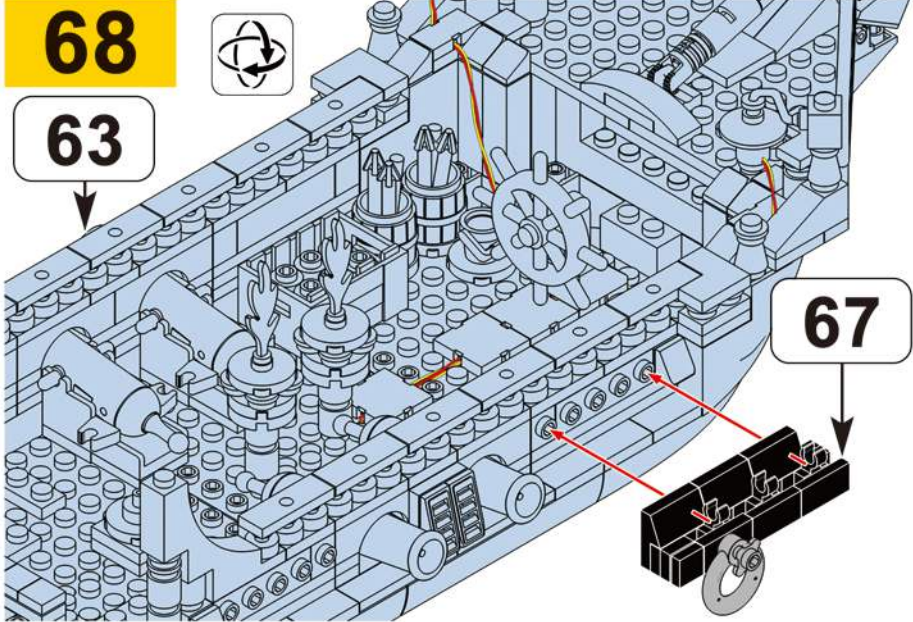
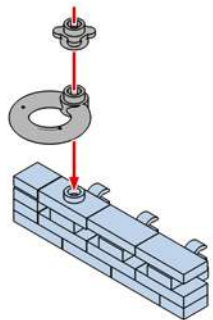

68

63

67

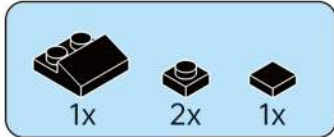

69

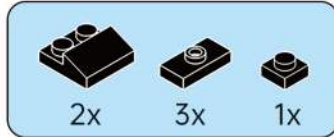
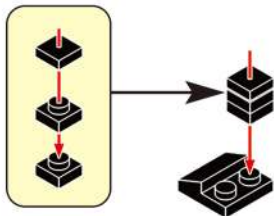

70

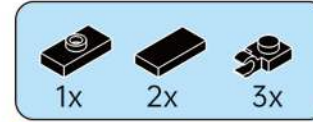
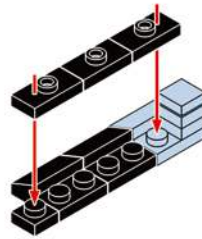

71

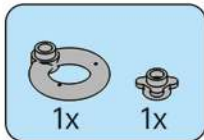
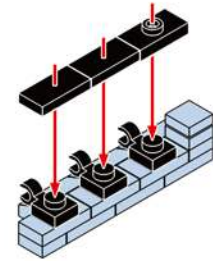

72

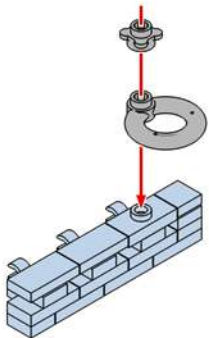

73

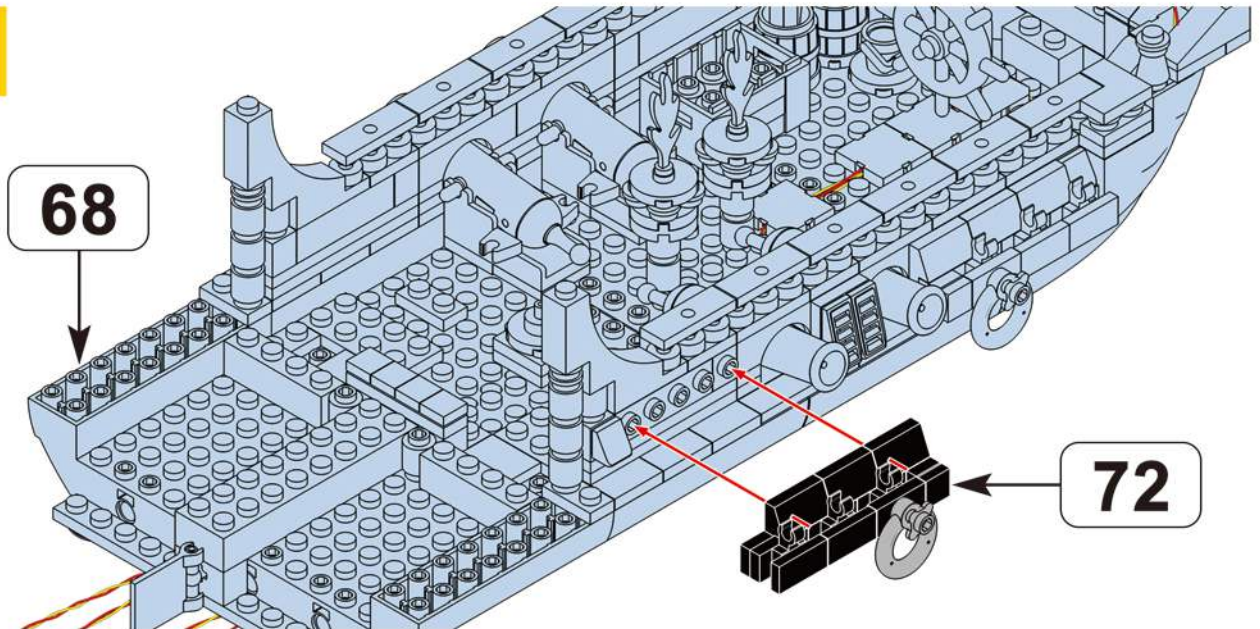

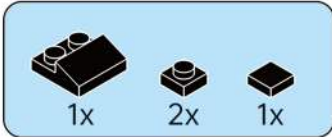

74

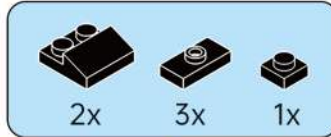
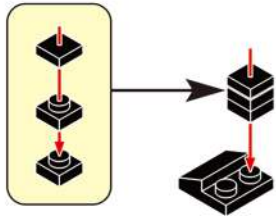

75

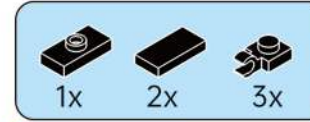
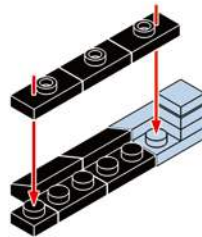

76

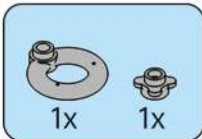
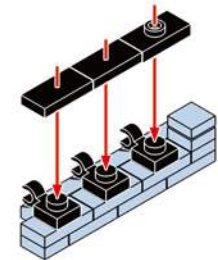

77

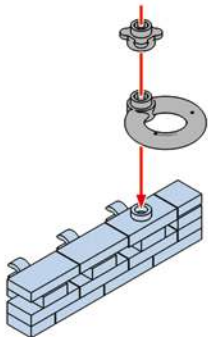

78

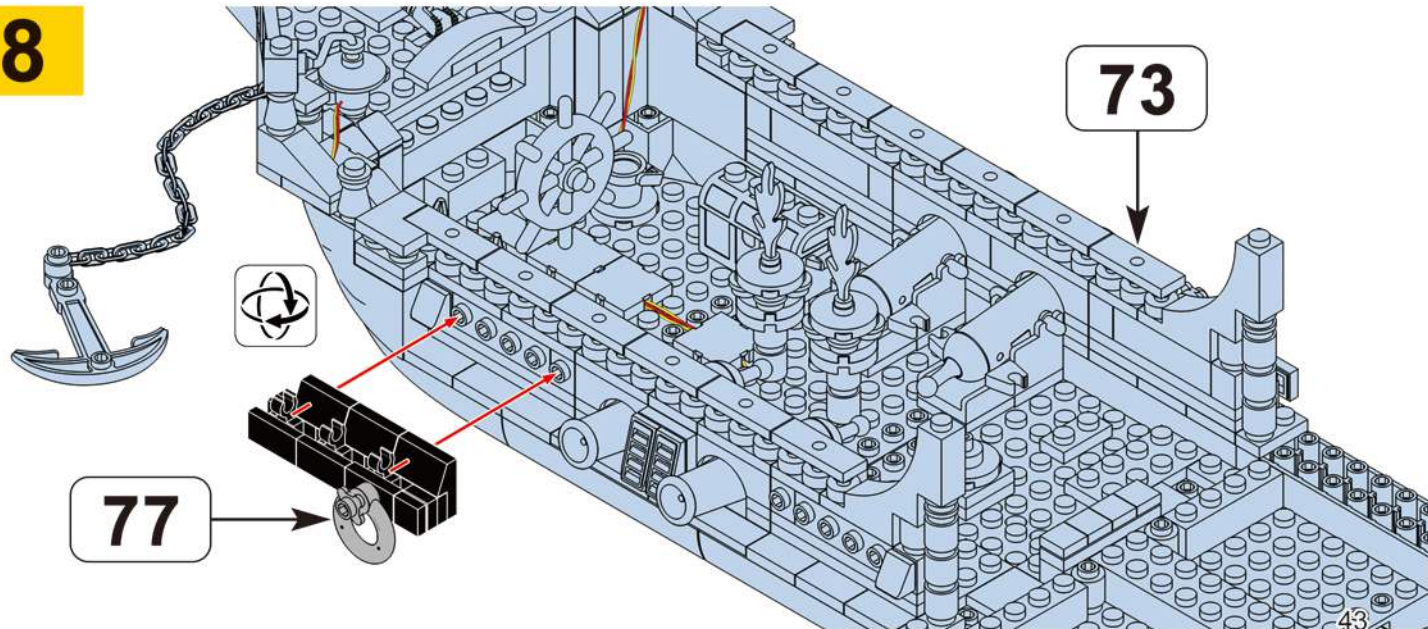

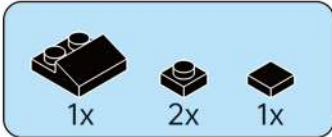

79

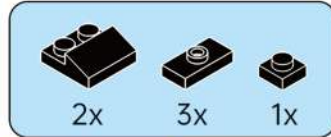
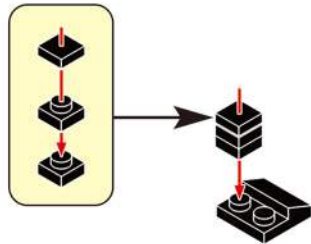

80

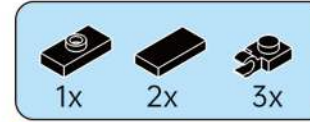
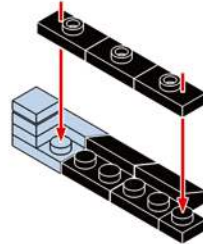

81

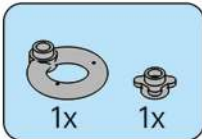
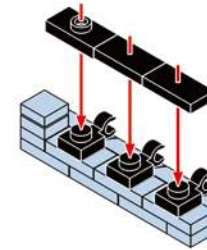

82

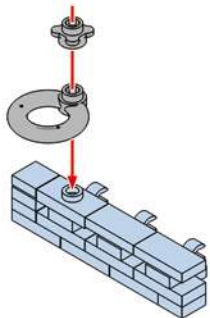

83

82

78

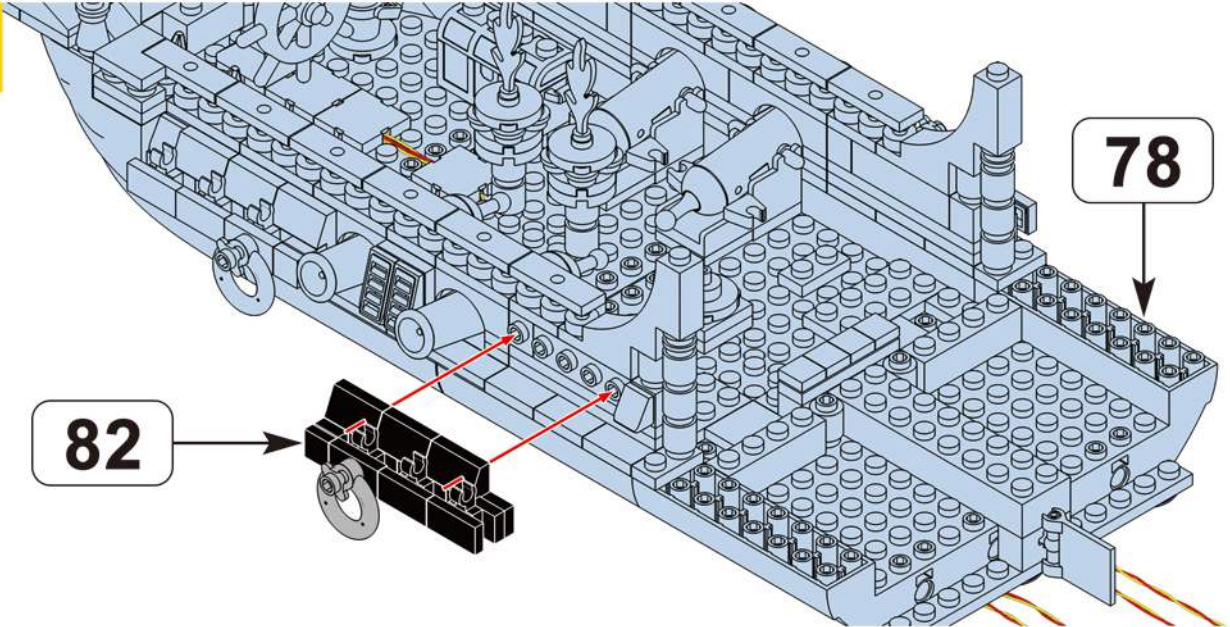

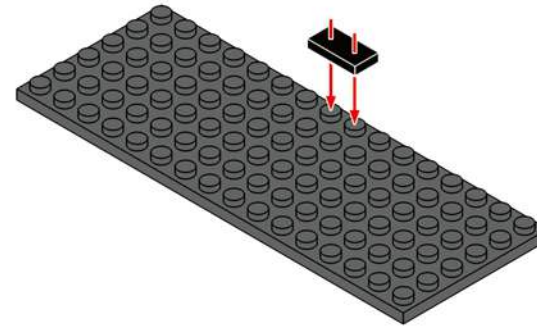
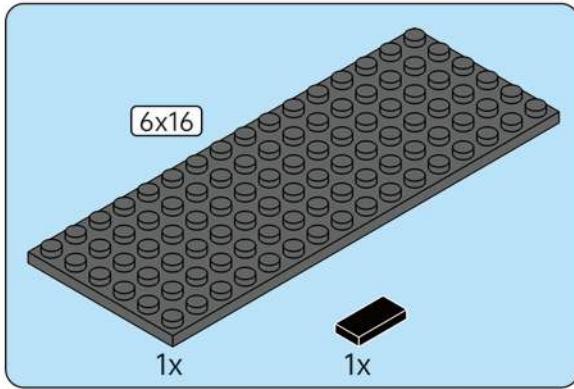

84

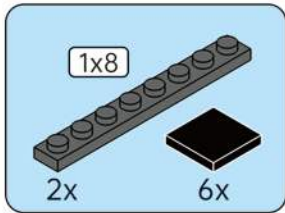

85

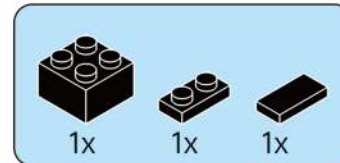
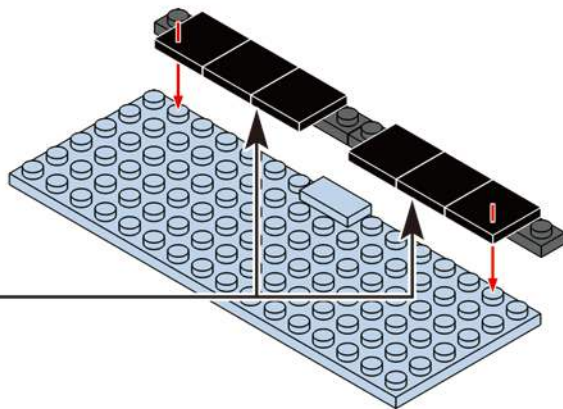
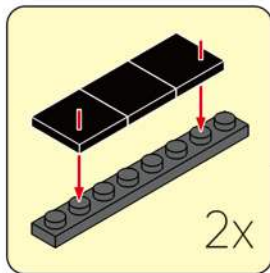

86

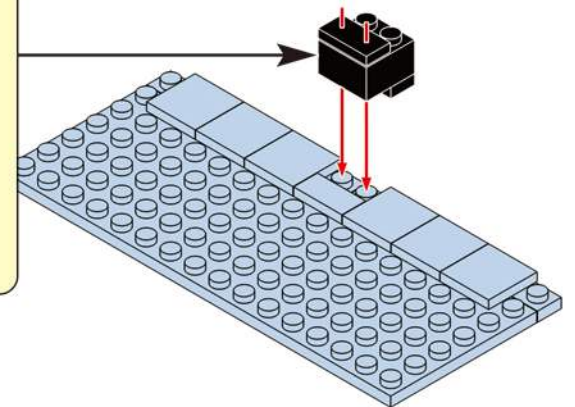
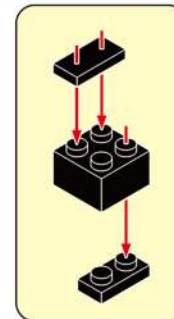

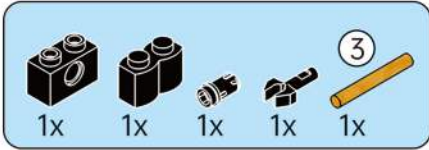

87

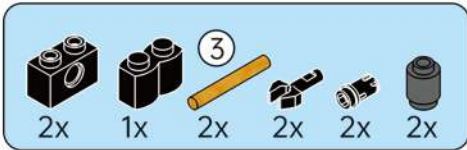
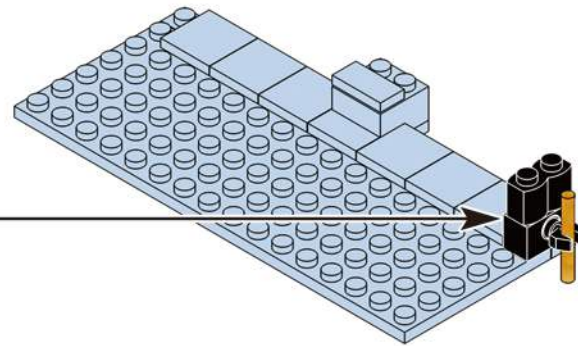
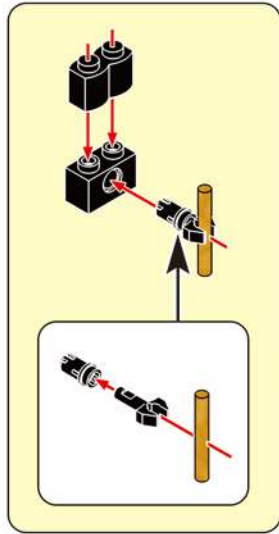

88

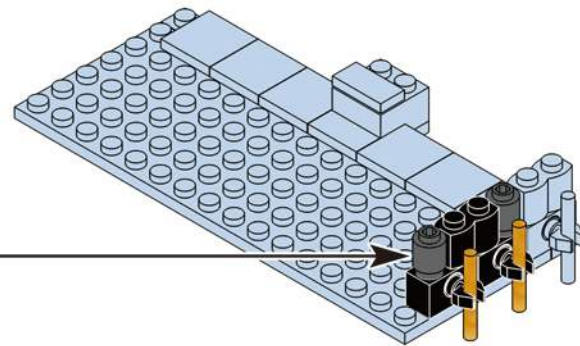
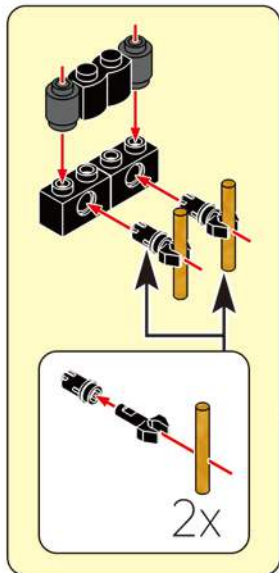

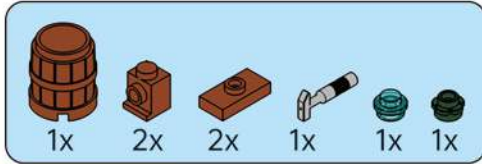

89

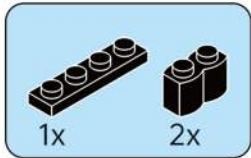
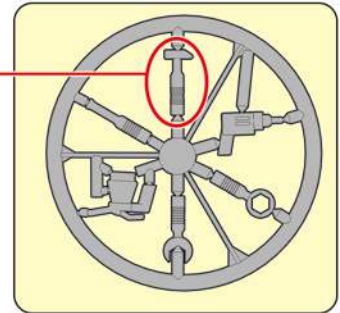
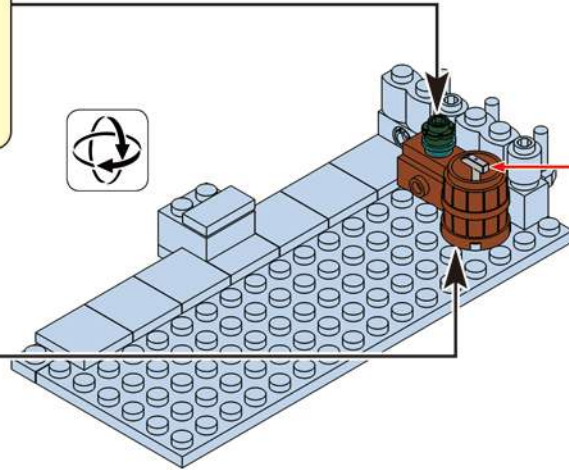
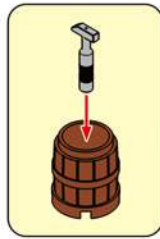
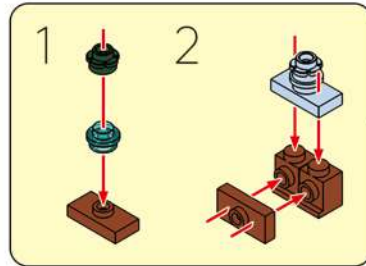

90

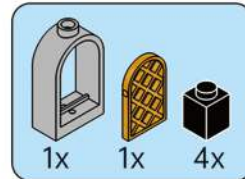
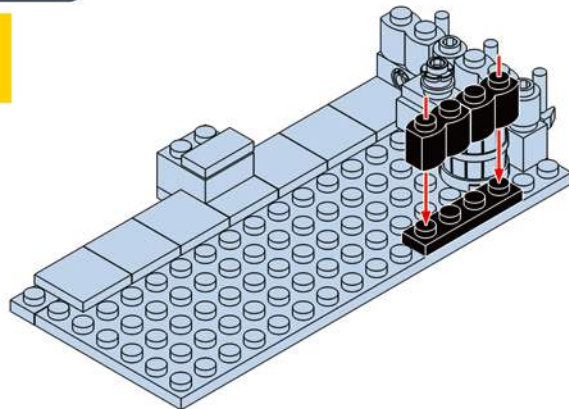

91

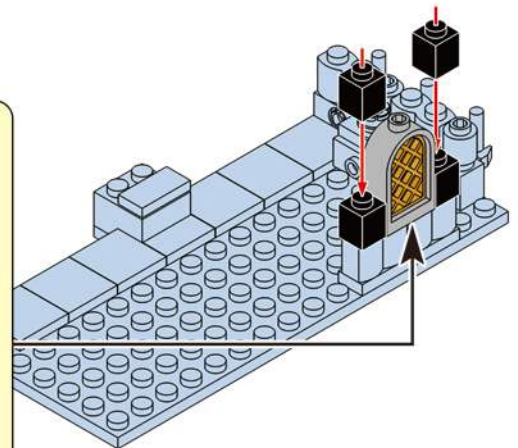
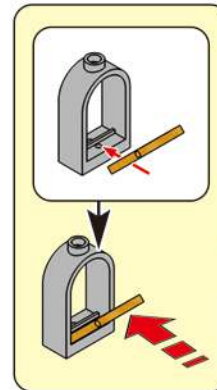

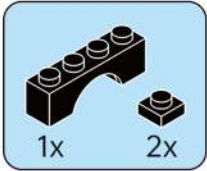

92

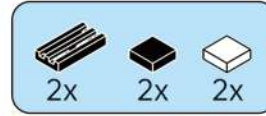
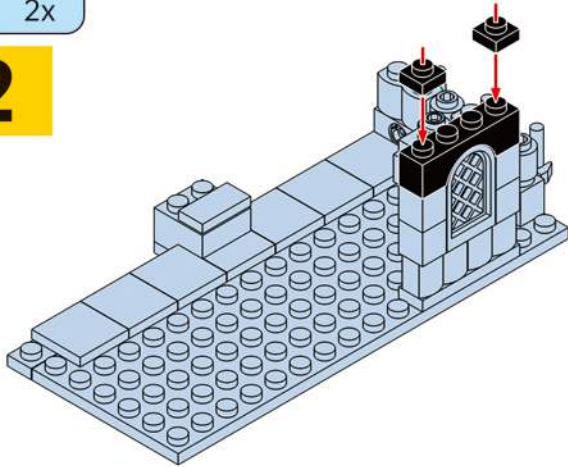

93

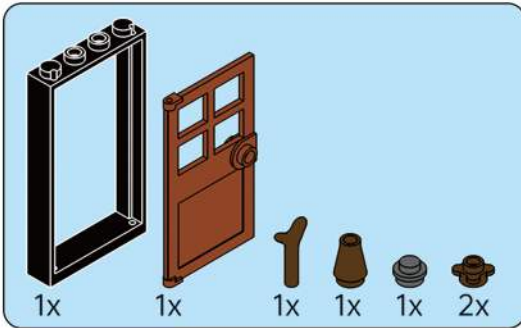
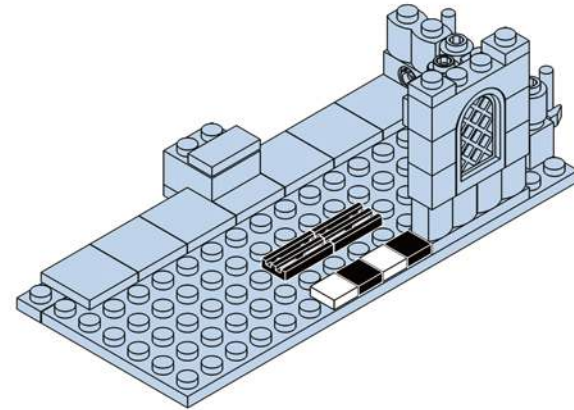

94

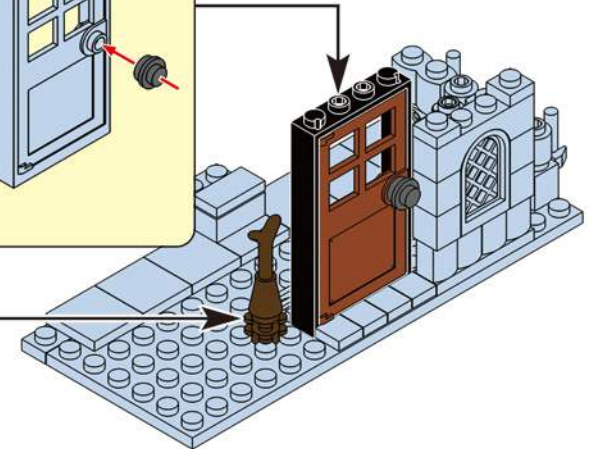
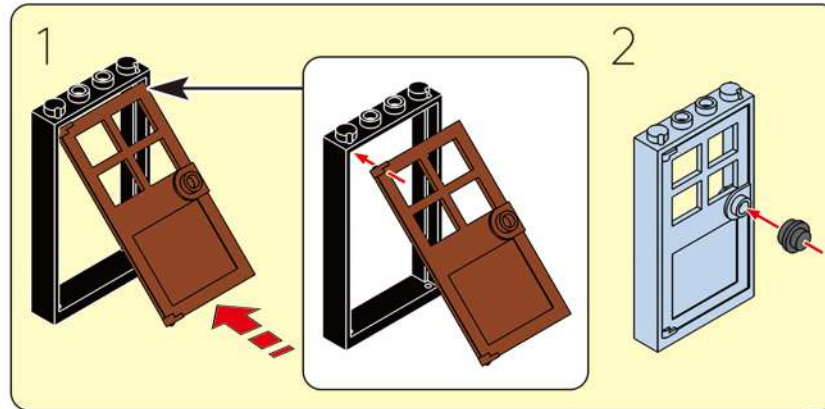
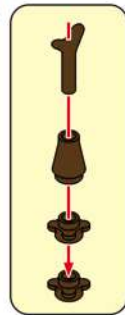

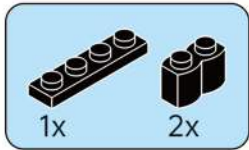

95

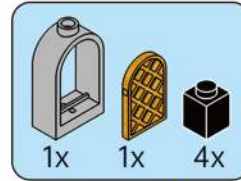
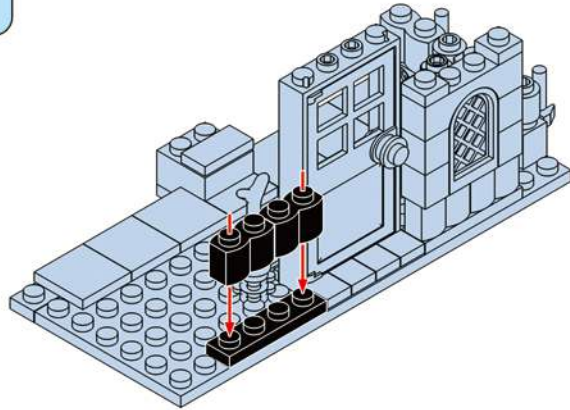

96

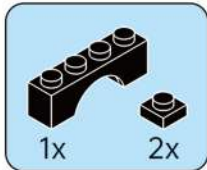
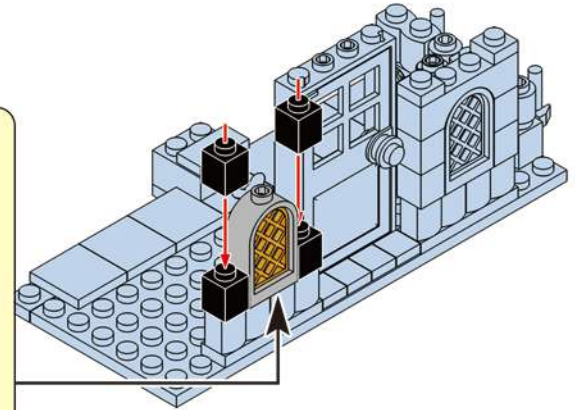
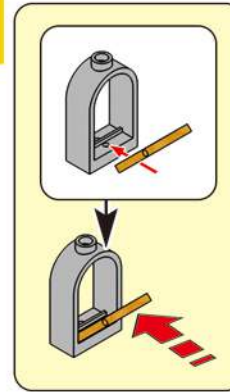

97

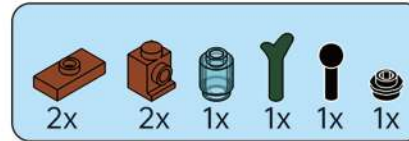
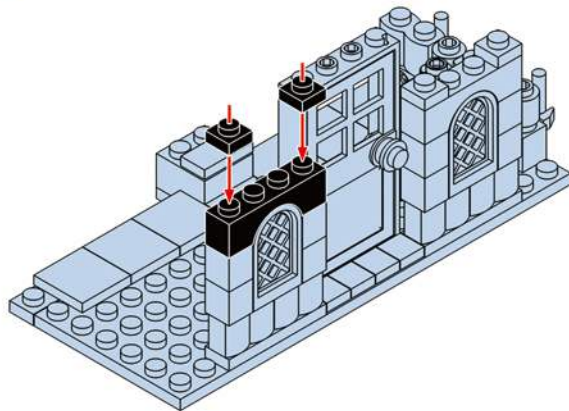

98

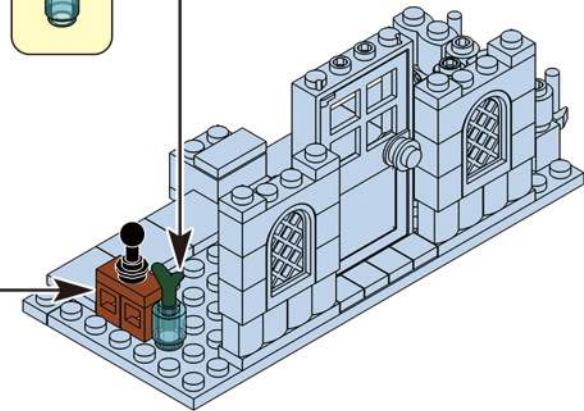
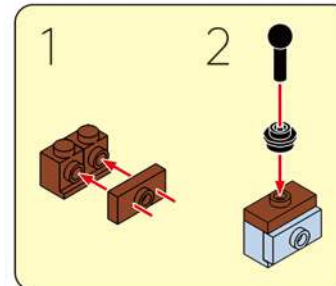
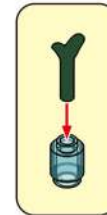

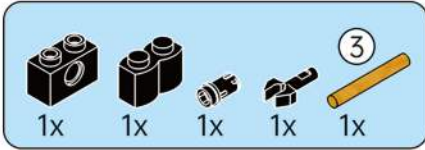

99

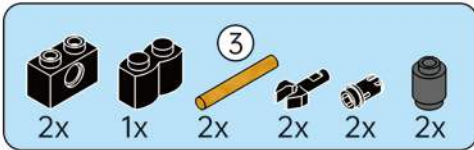
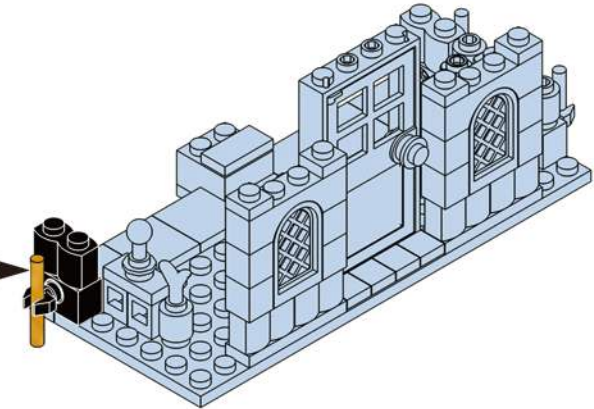
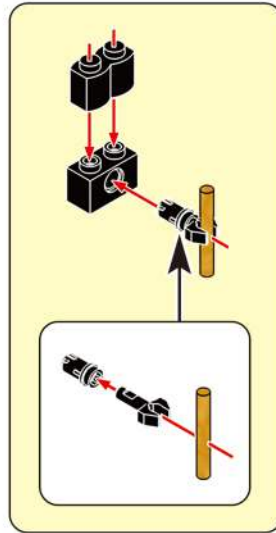

100

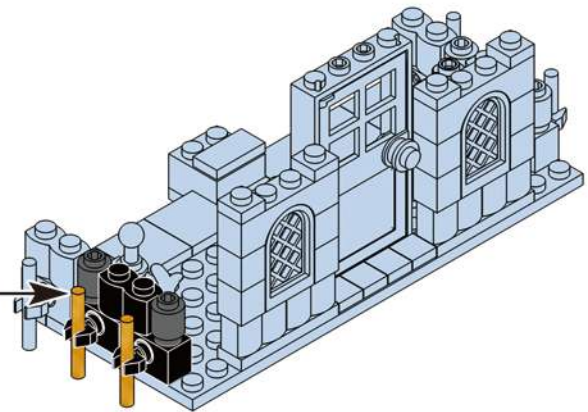
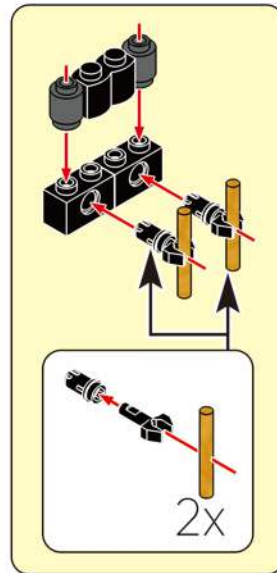

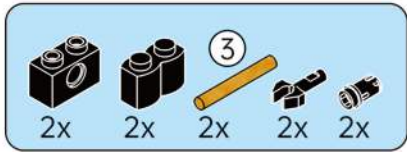

# 101

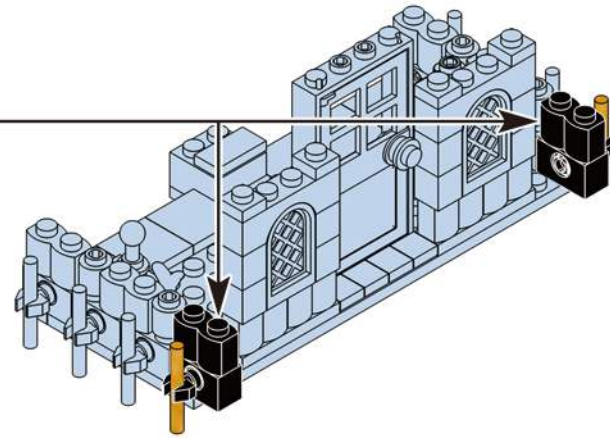
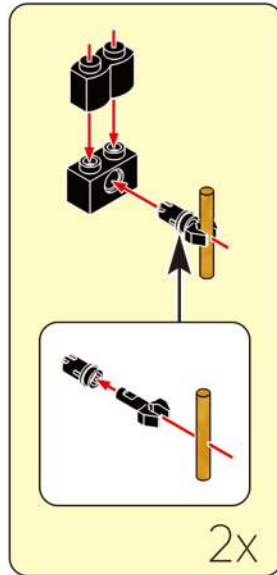

# 102

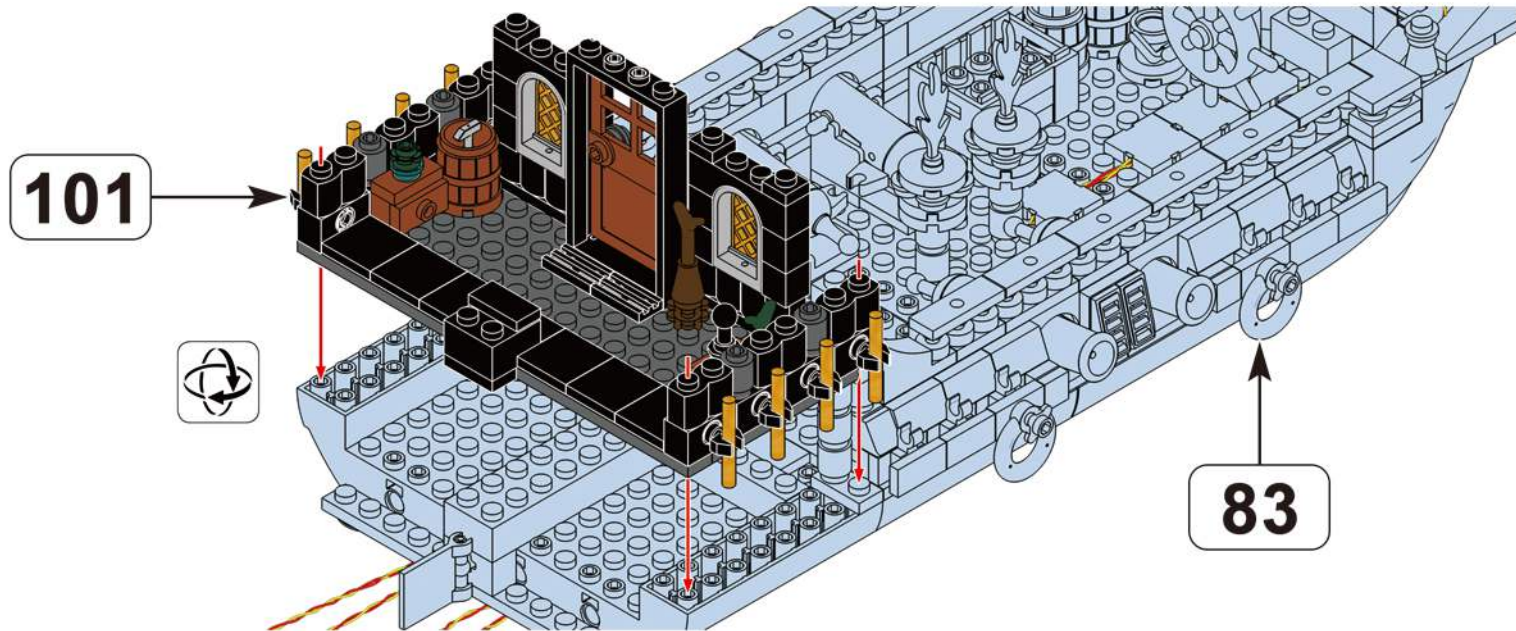

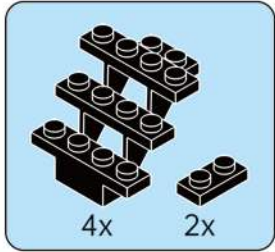

**103**

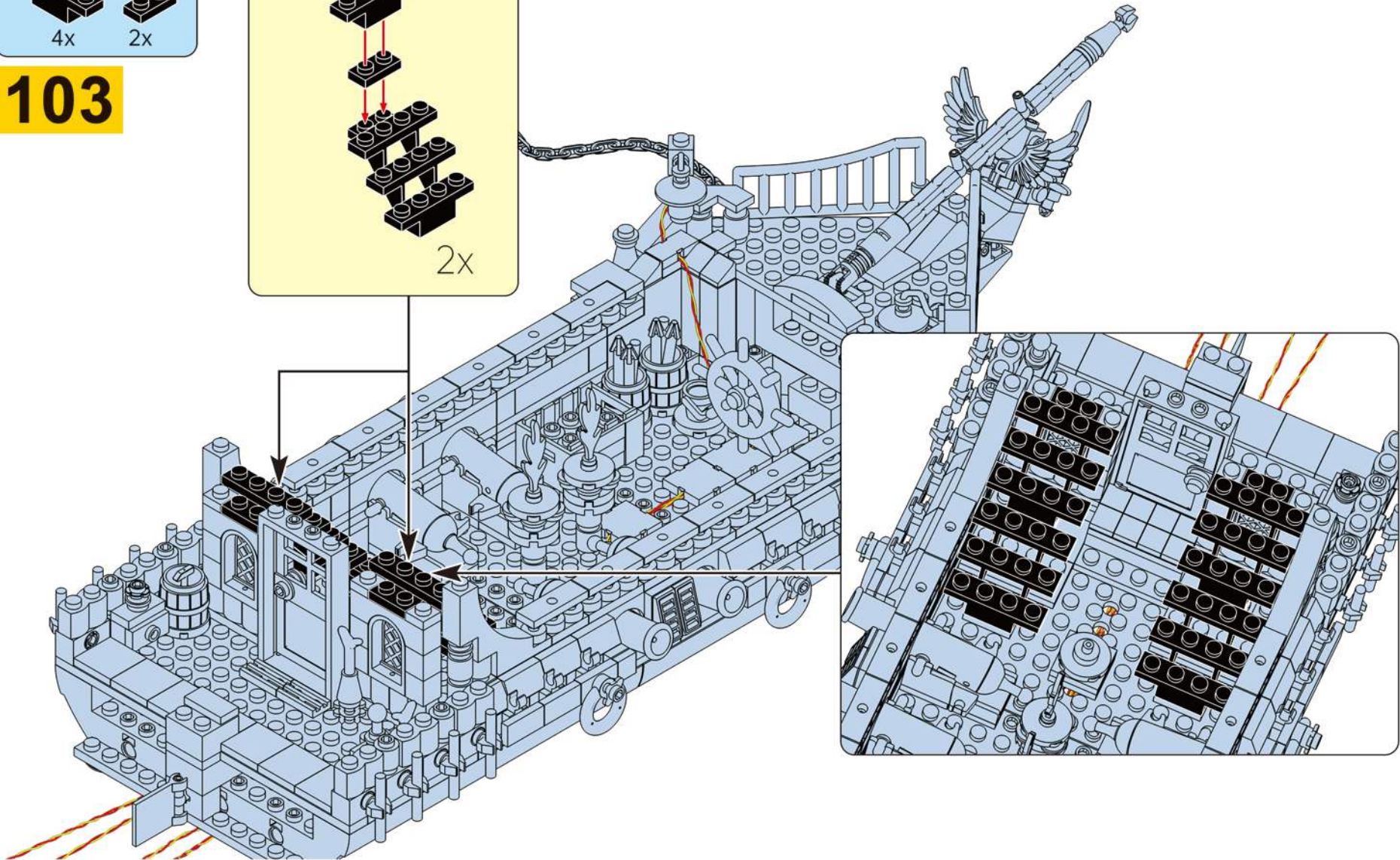
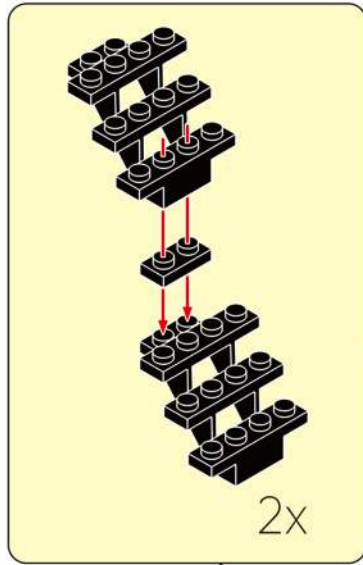

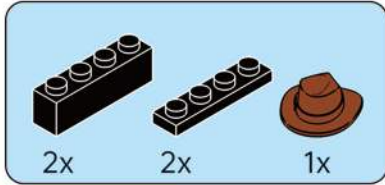

104

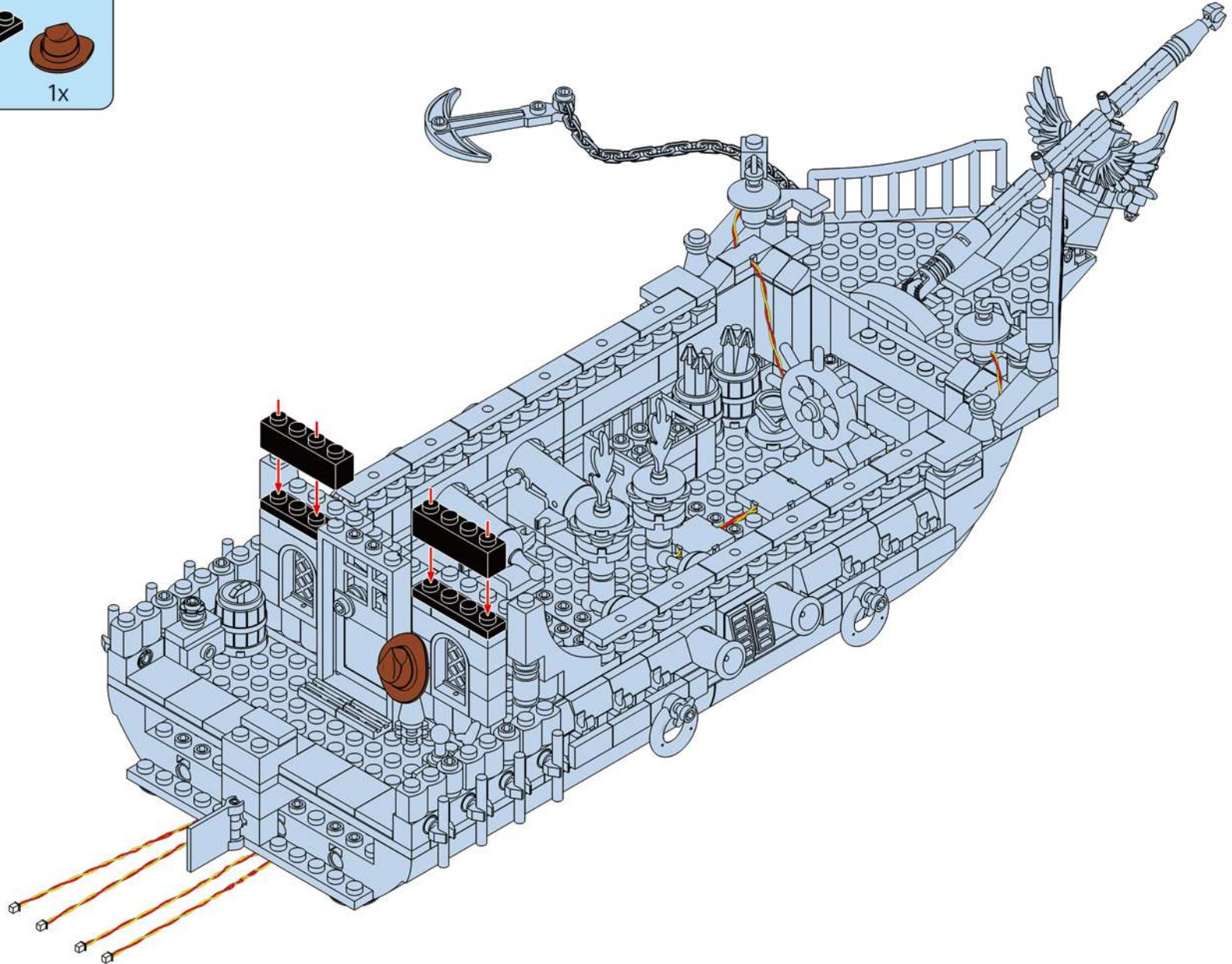

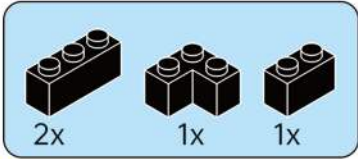

105

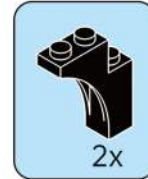
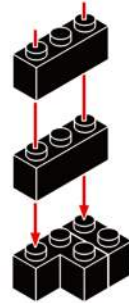

106

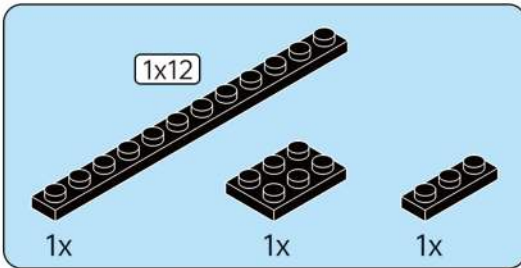
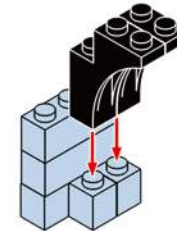

107

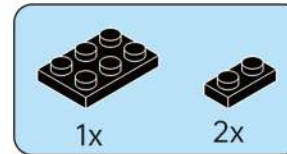
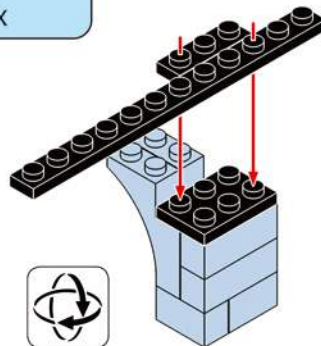

108

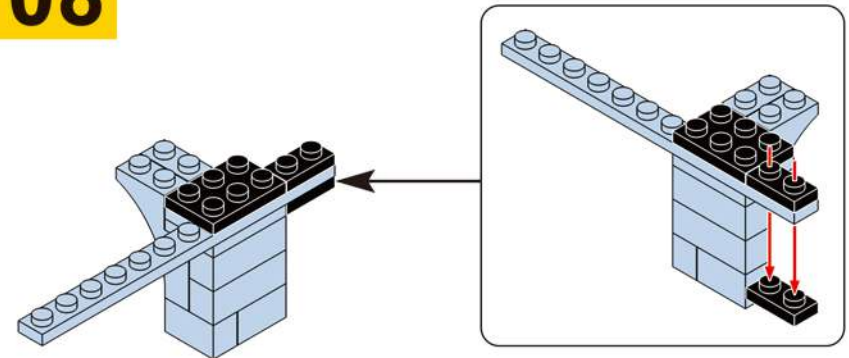

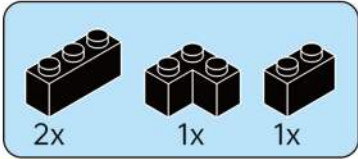

109

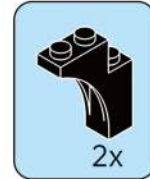
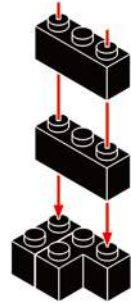

110

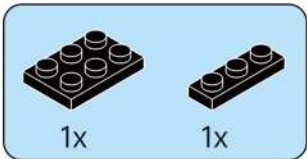
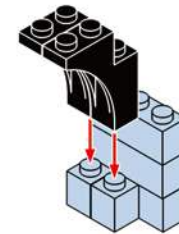

111

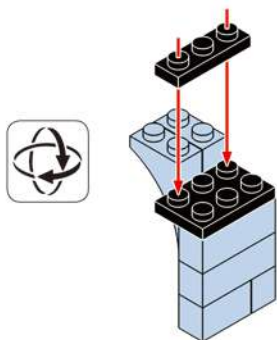

112

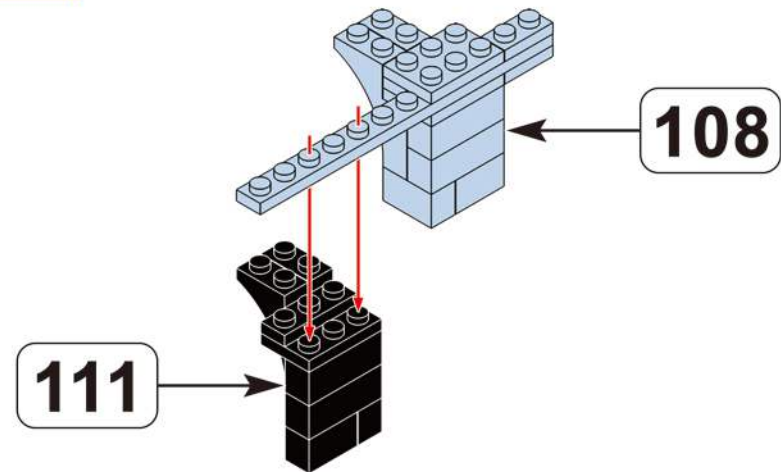

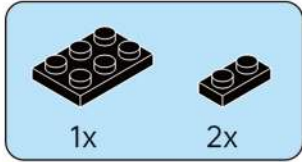

113

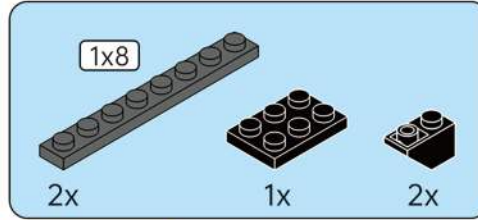
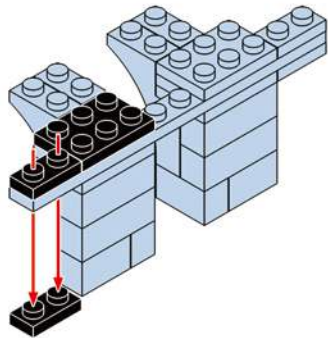

114

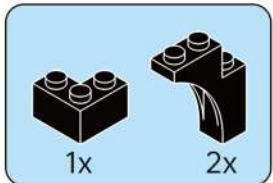
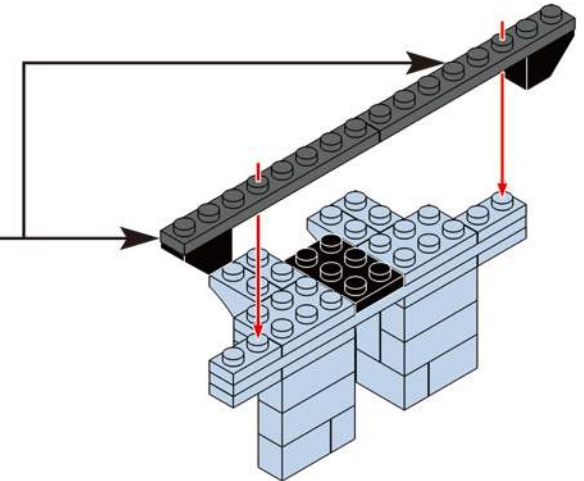
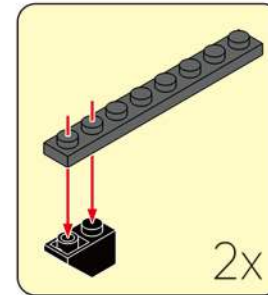

115

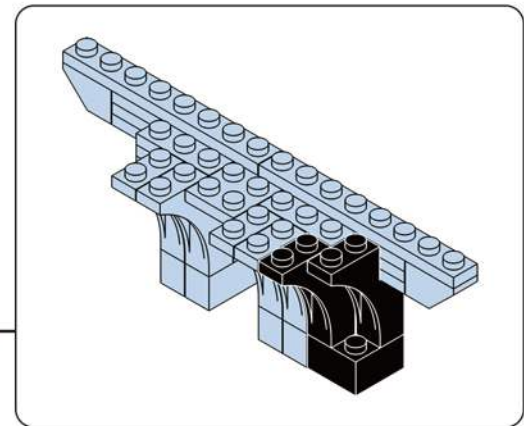
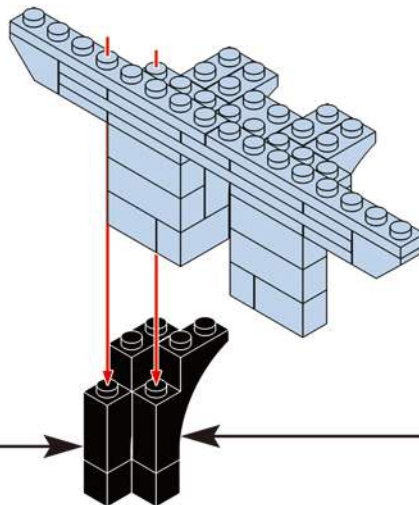
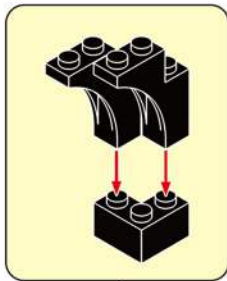

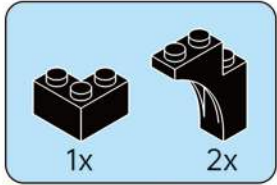

116

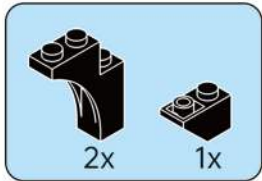
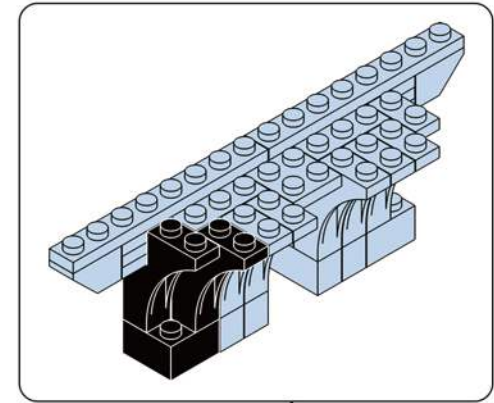
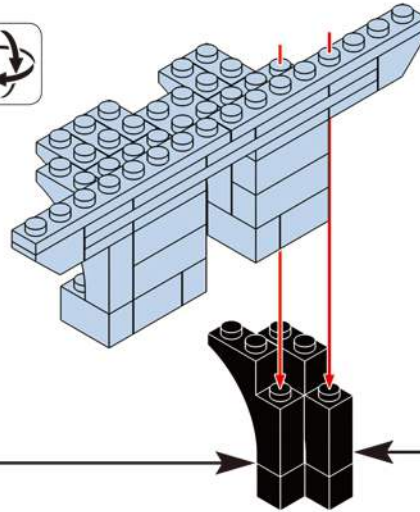
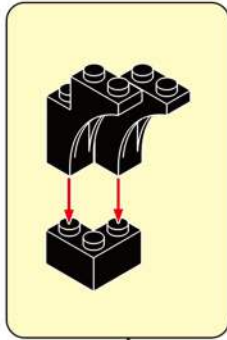

117

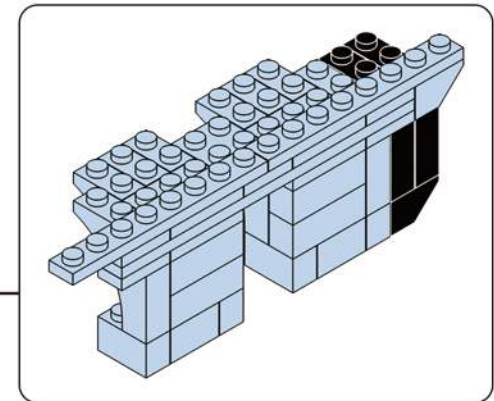
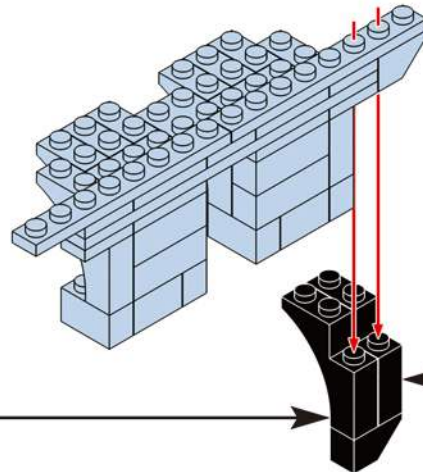
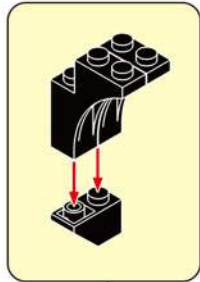

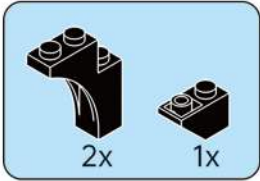

118

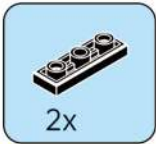
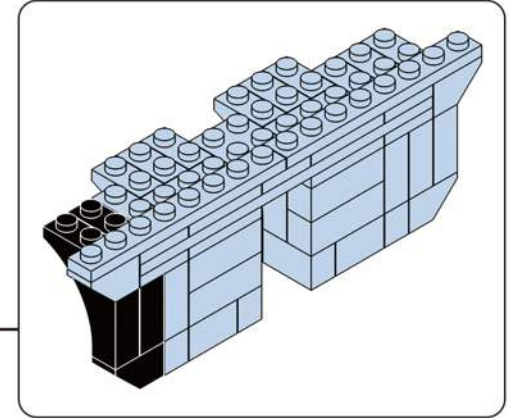
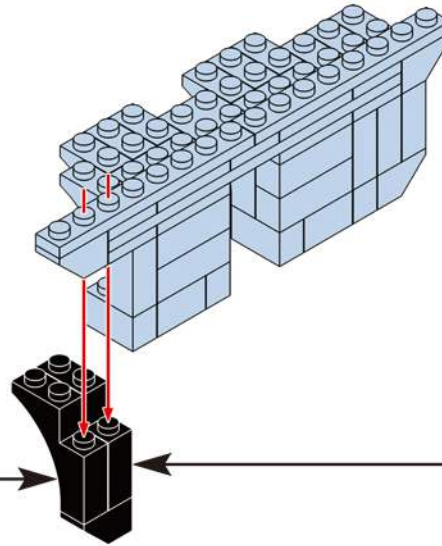
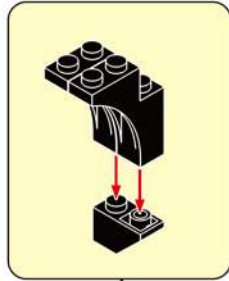

119

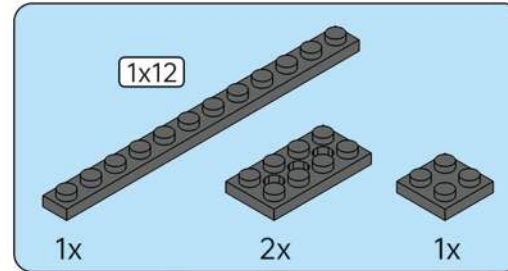
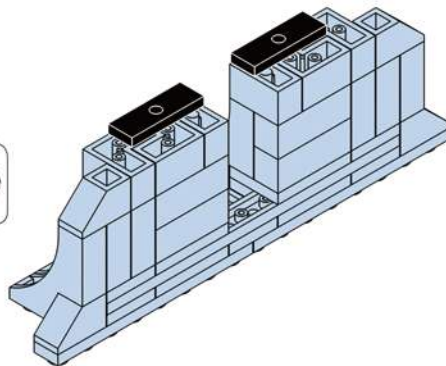

120

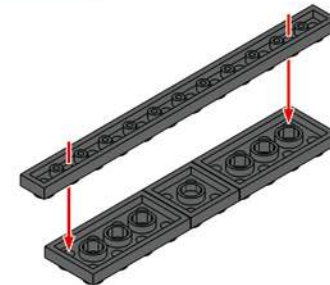

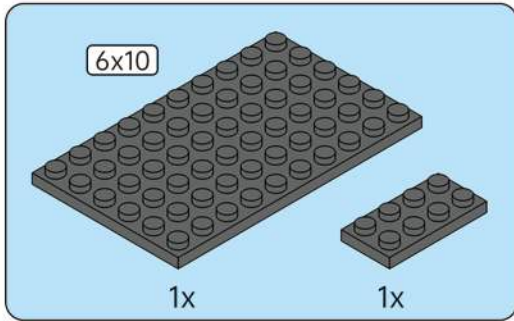

121

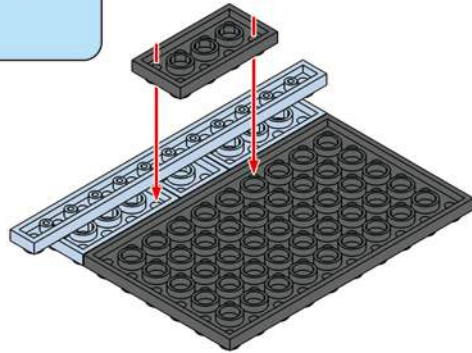

122

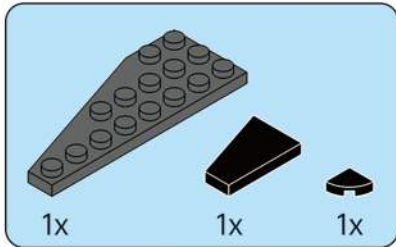
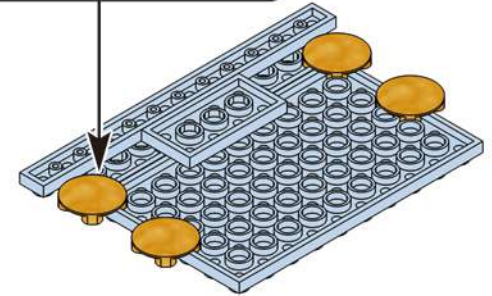
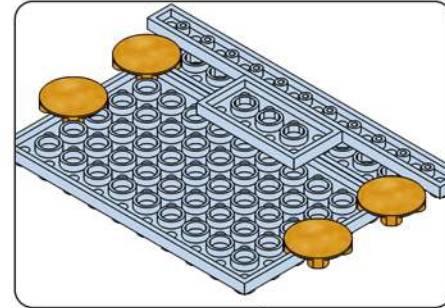

123

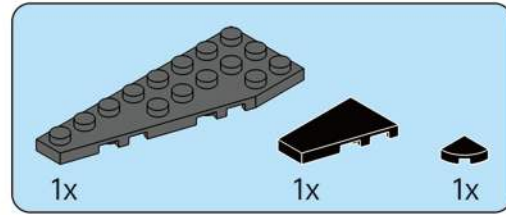
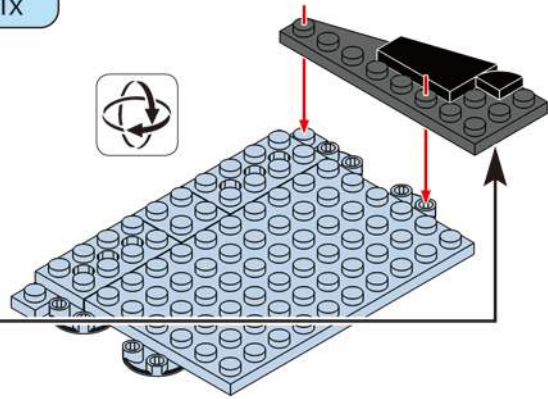
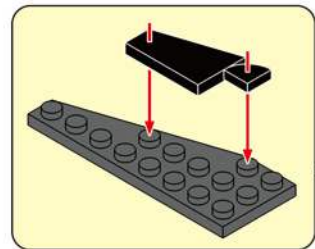

124

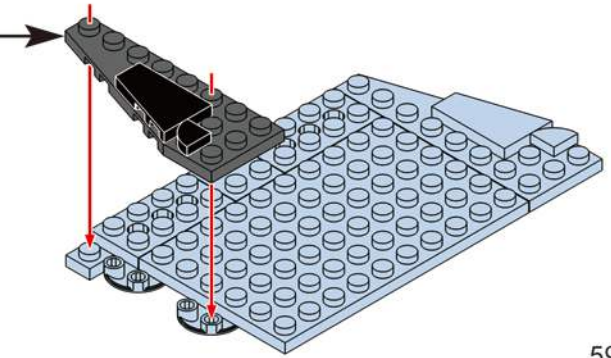
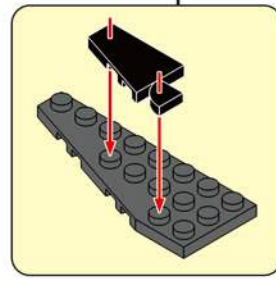

# 125

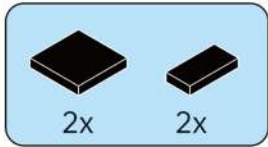
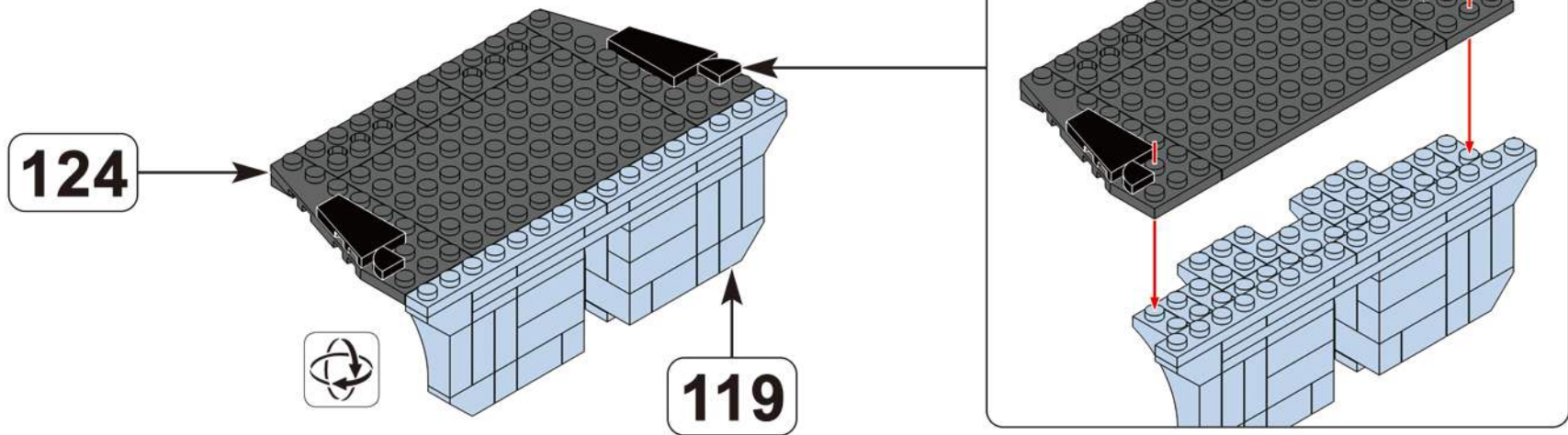

# 126

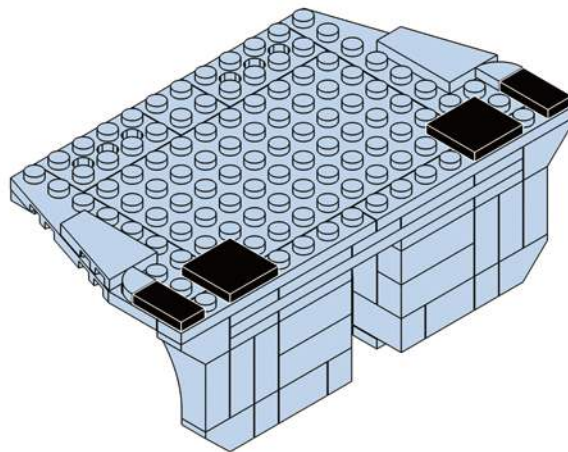

127

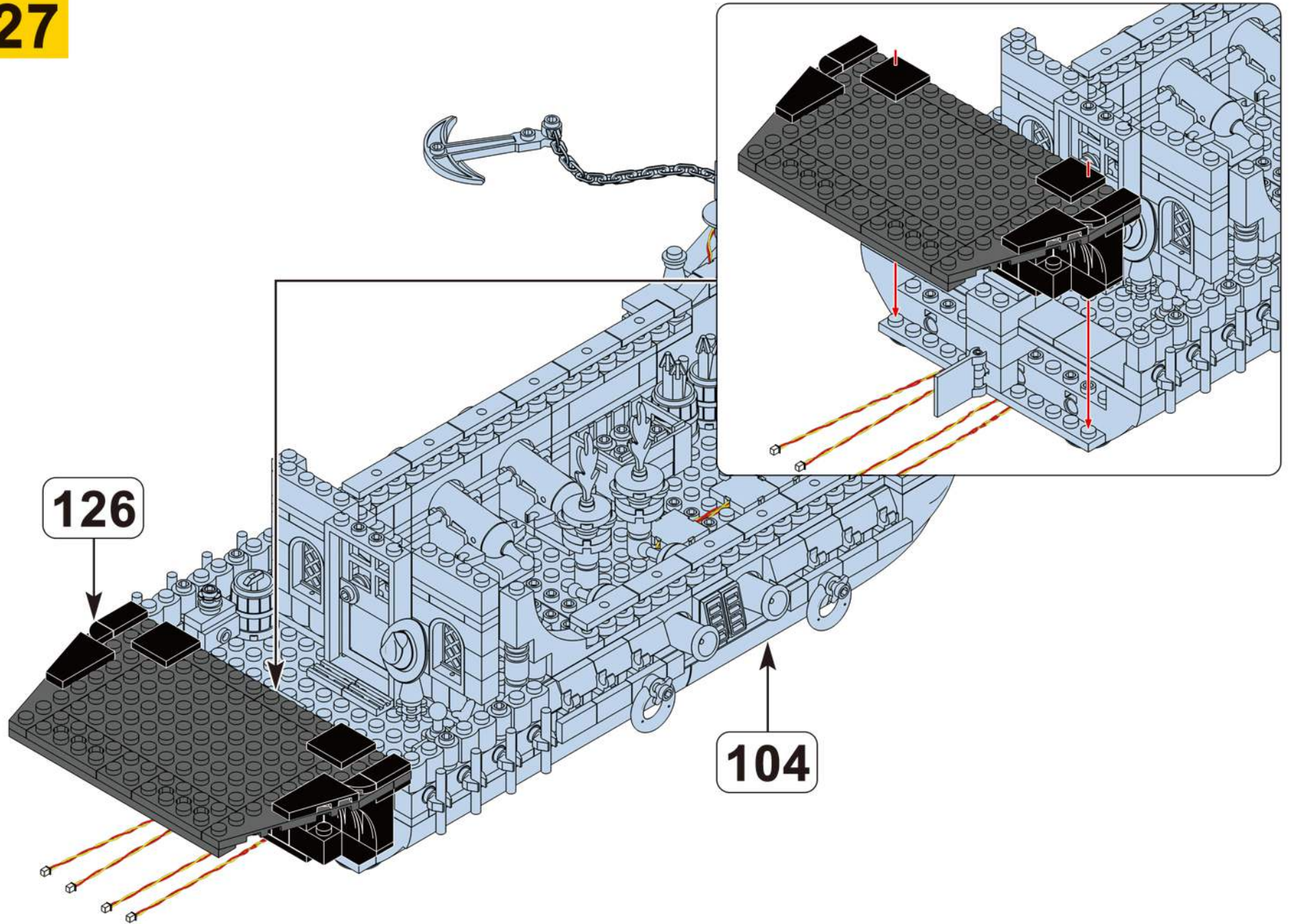

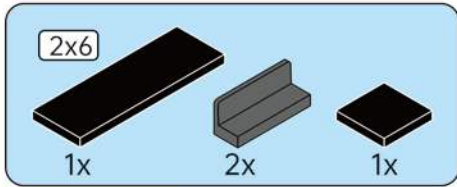

128

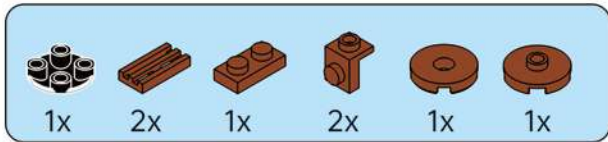
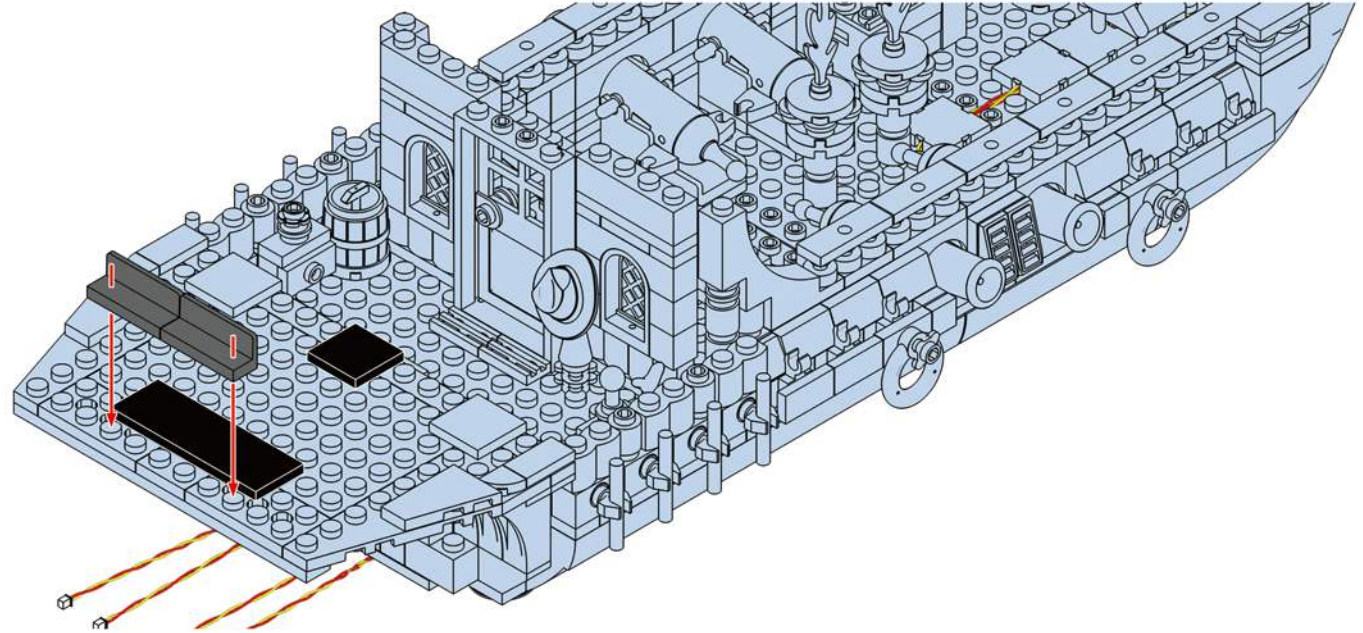

129

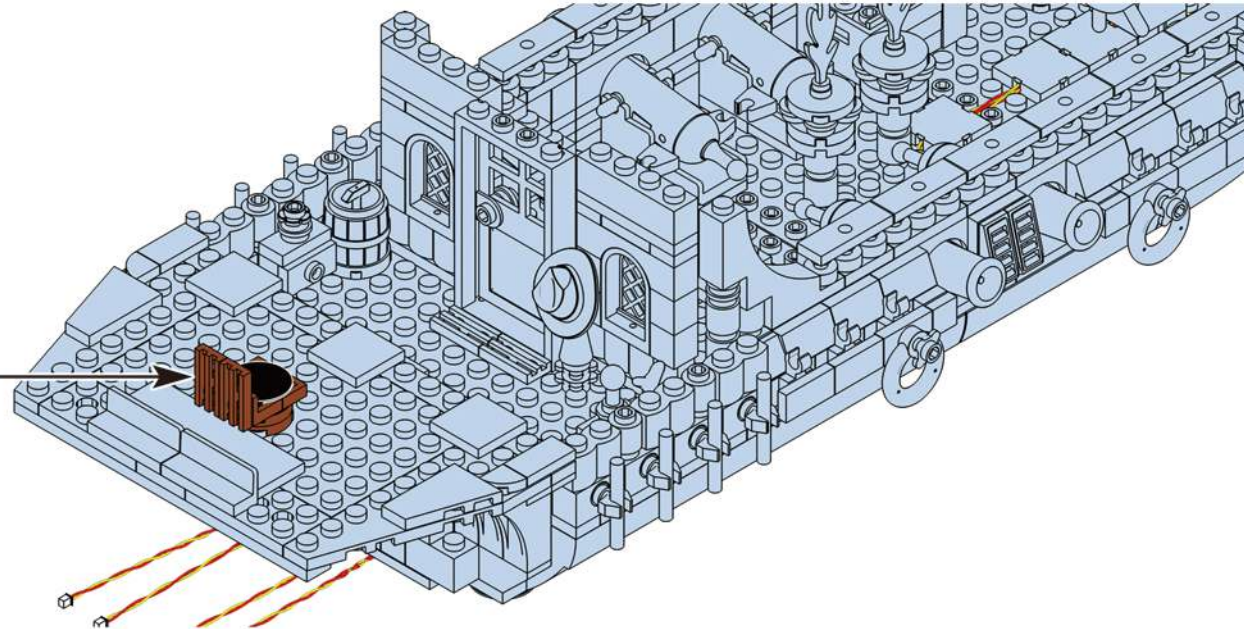
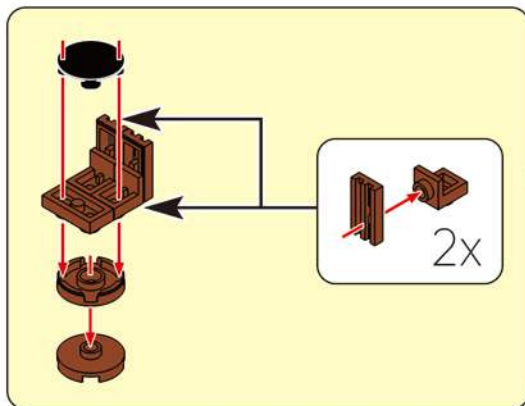

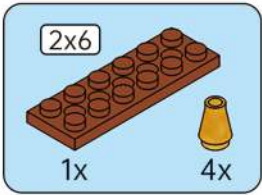

**130**

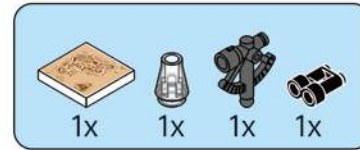
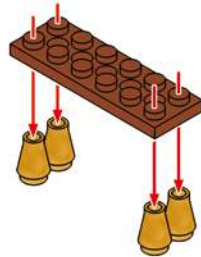

**131**

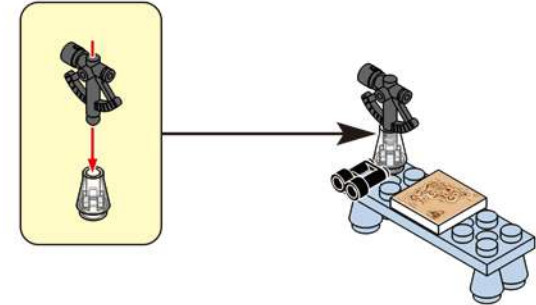

**132**

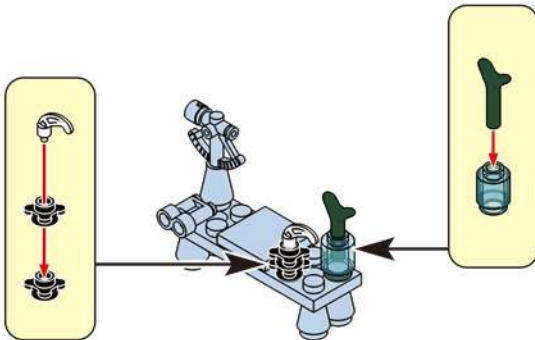

**133**

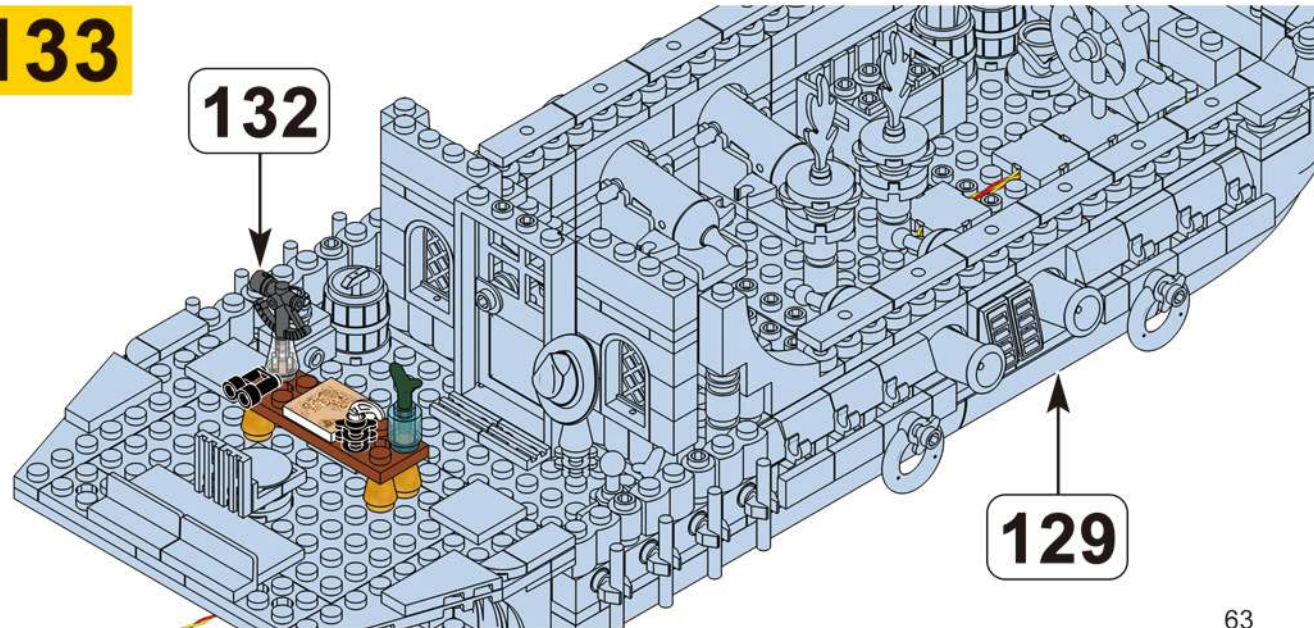

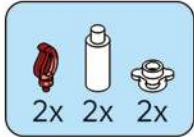

134

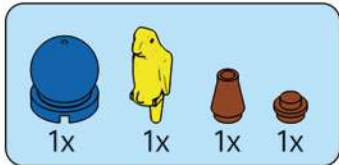
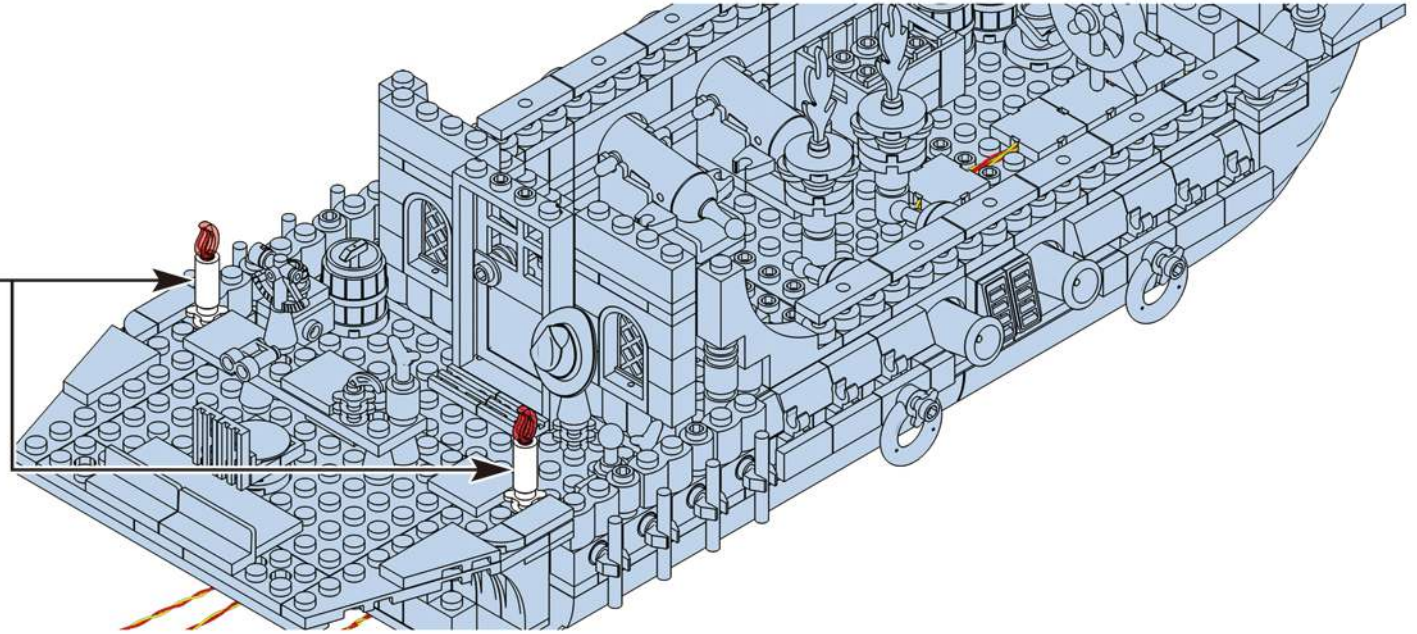
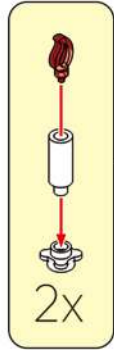

135

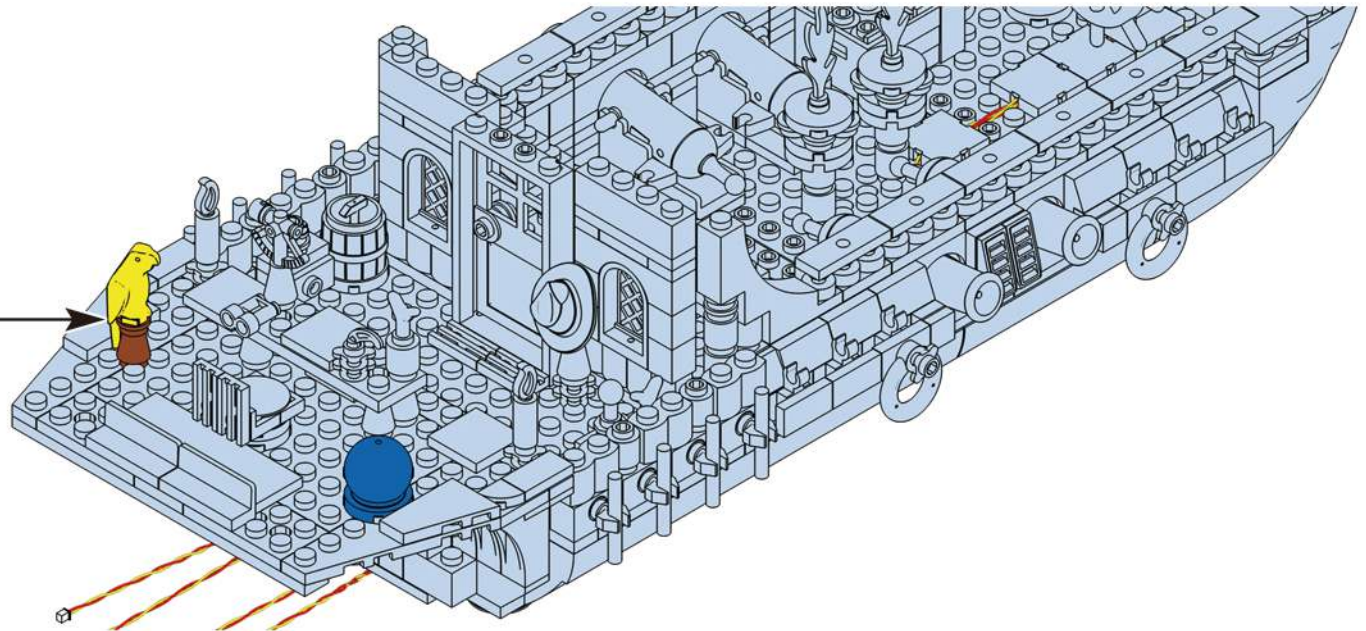
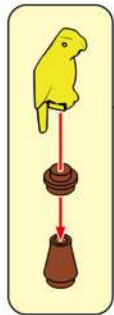

# JOY MAKES BRILLIANCE.

## Embrace Relaxation Embrace Joy

Every adultescent needs a "JOY BOX".  
Please , open your JOY BOX ! Heading for joy.

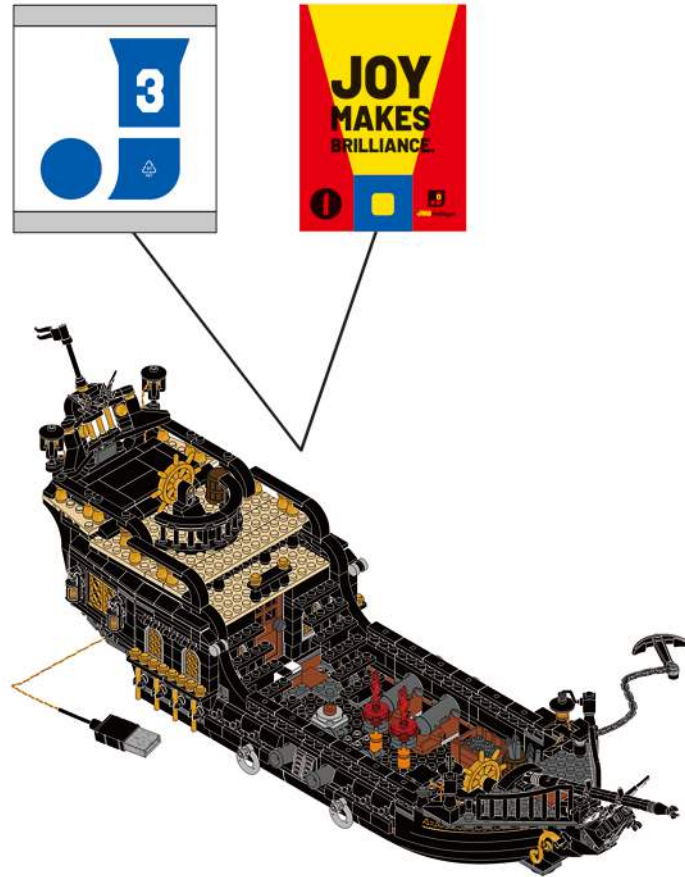

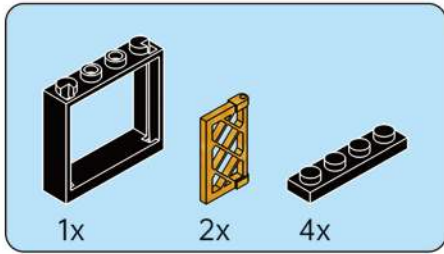

**136**

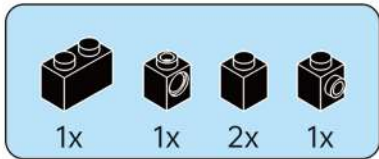
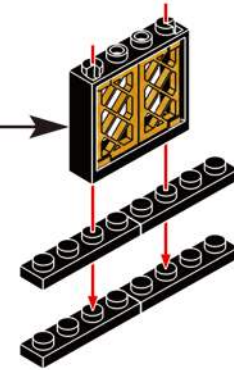
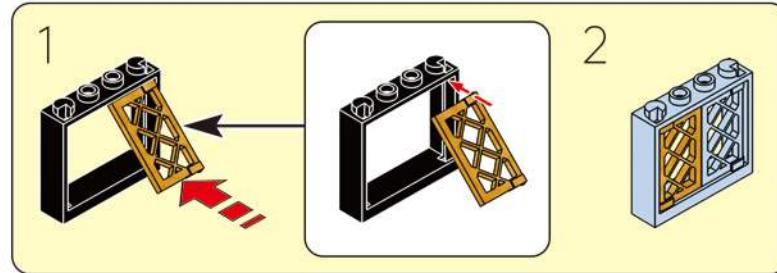

**137**

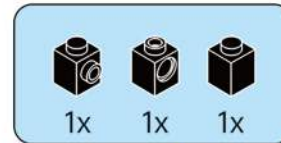
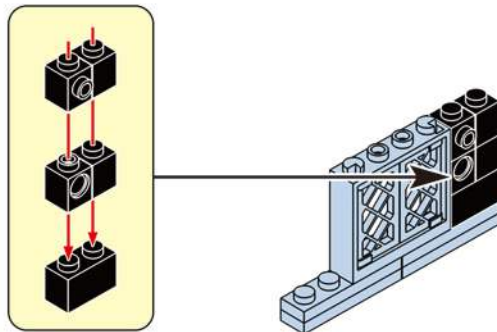

**138**

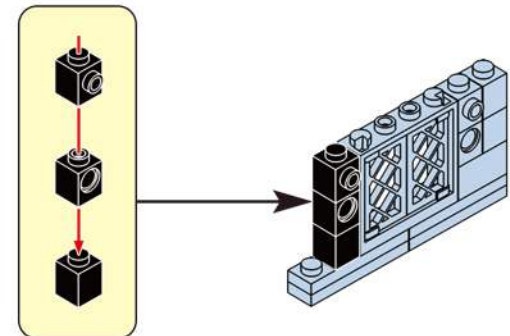



139

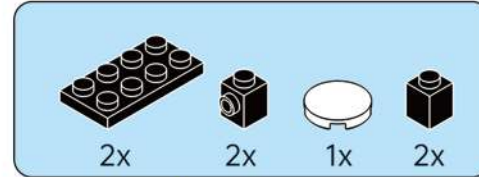
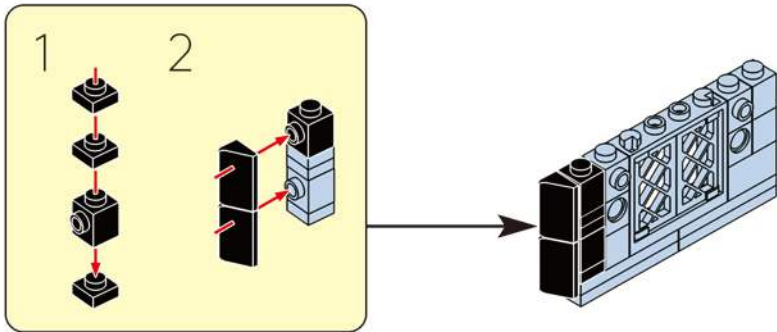

140

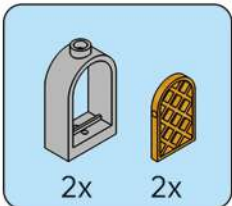
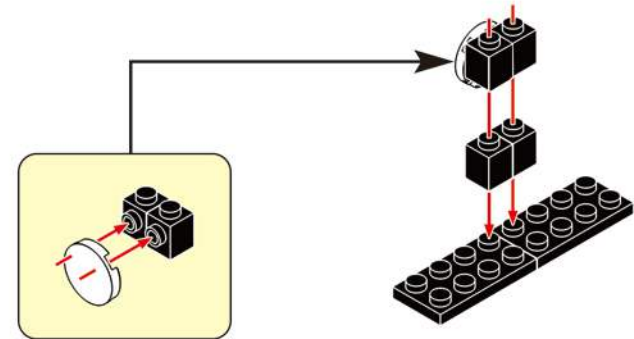

141

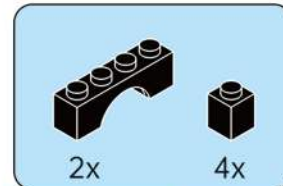
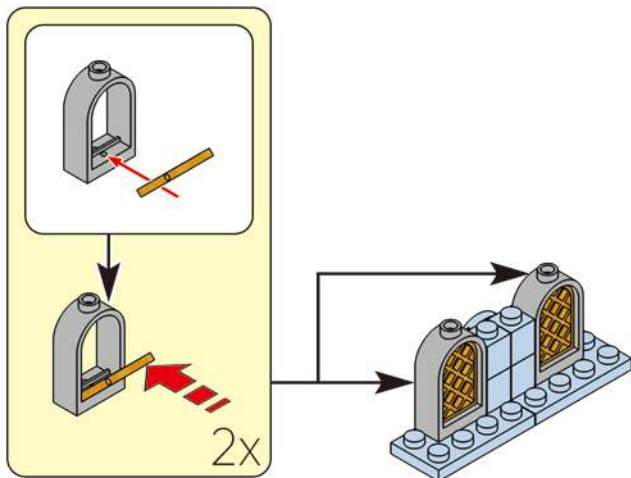

142

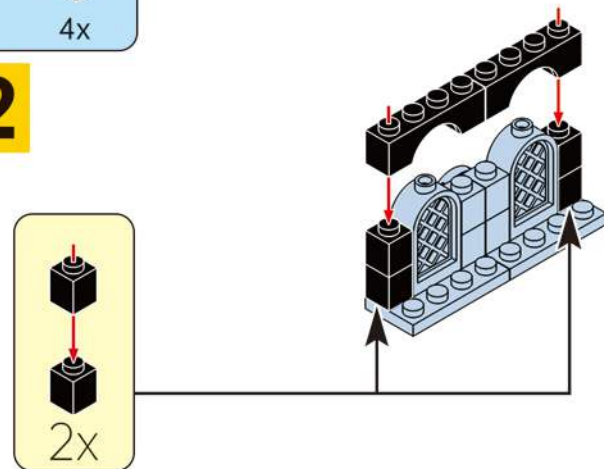

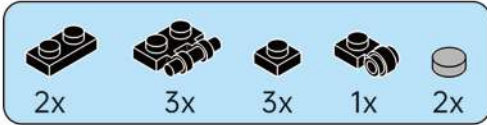

143

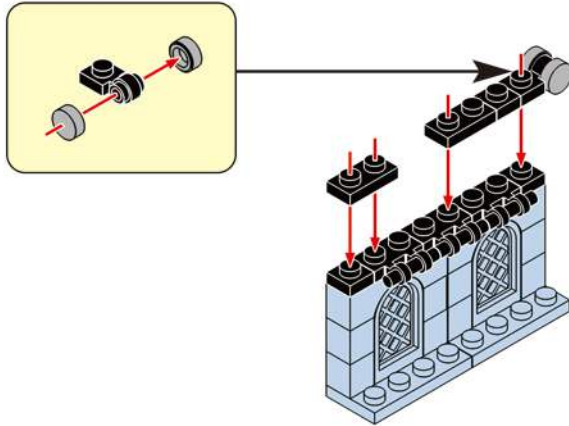

144

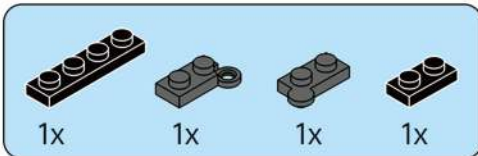
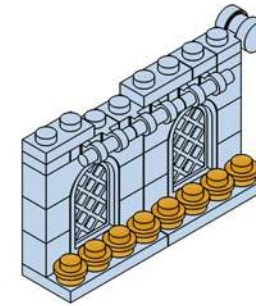

145

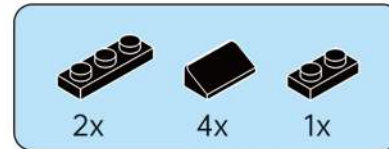
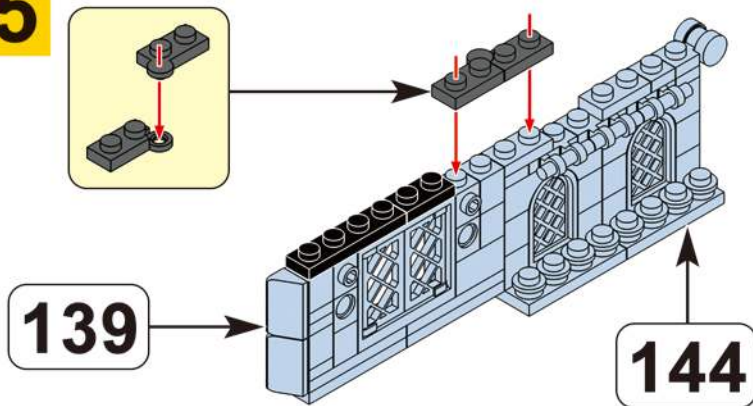

146

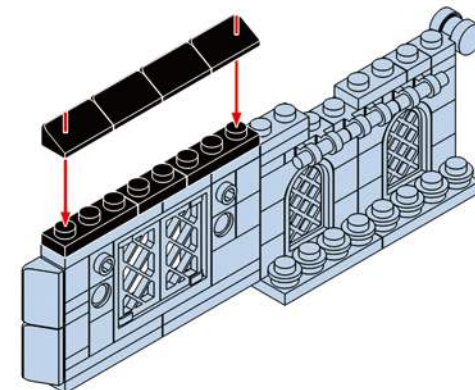

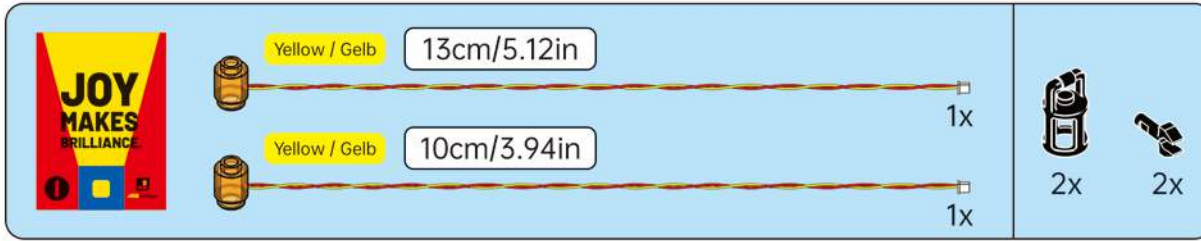

JOY MAKES BRILLIANCE

Yellow / Gelb 13cm/5.12in 1x

Yellow / Gelb 10cm/3.94in 1x

2x

2x

**147**

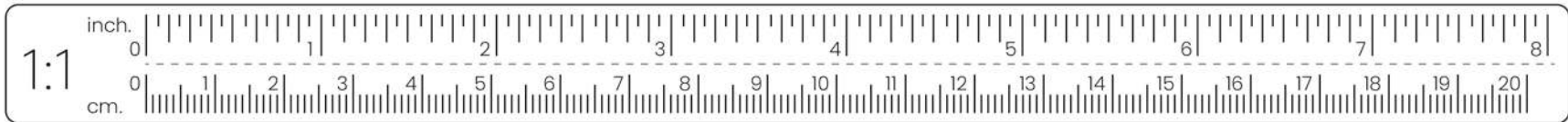
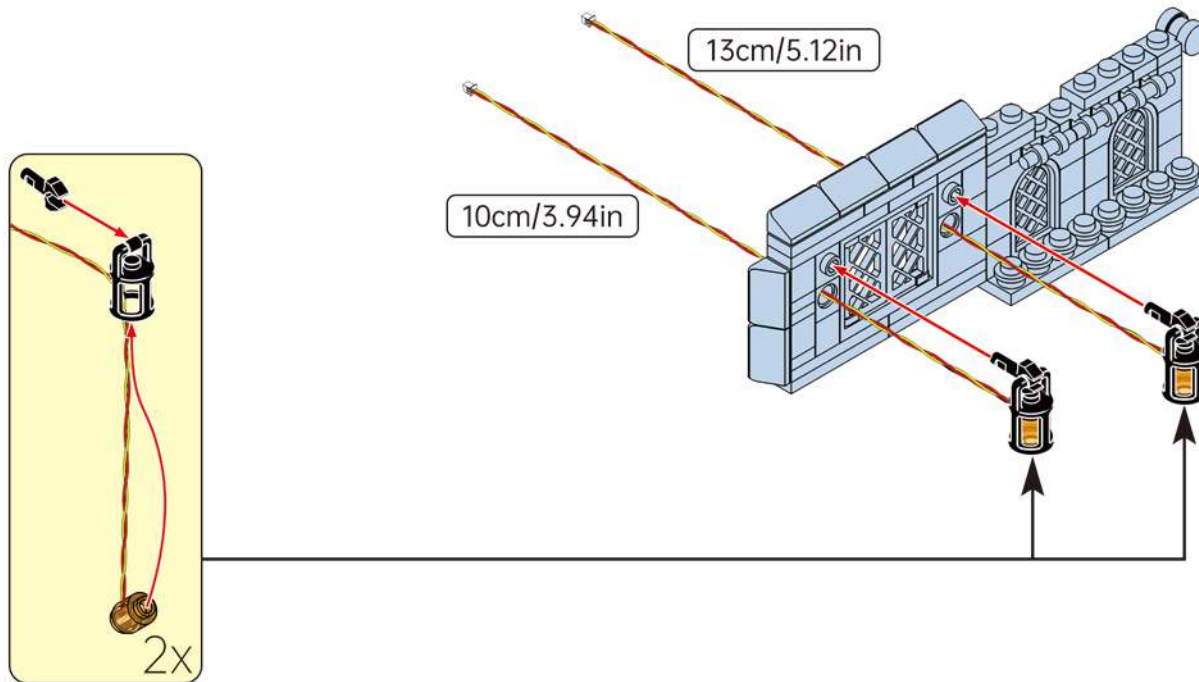

148

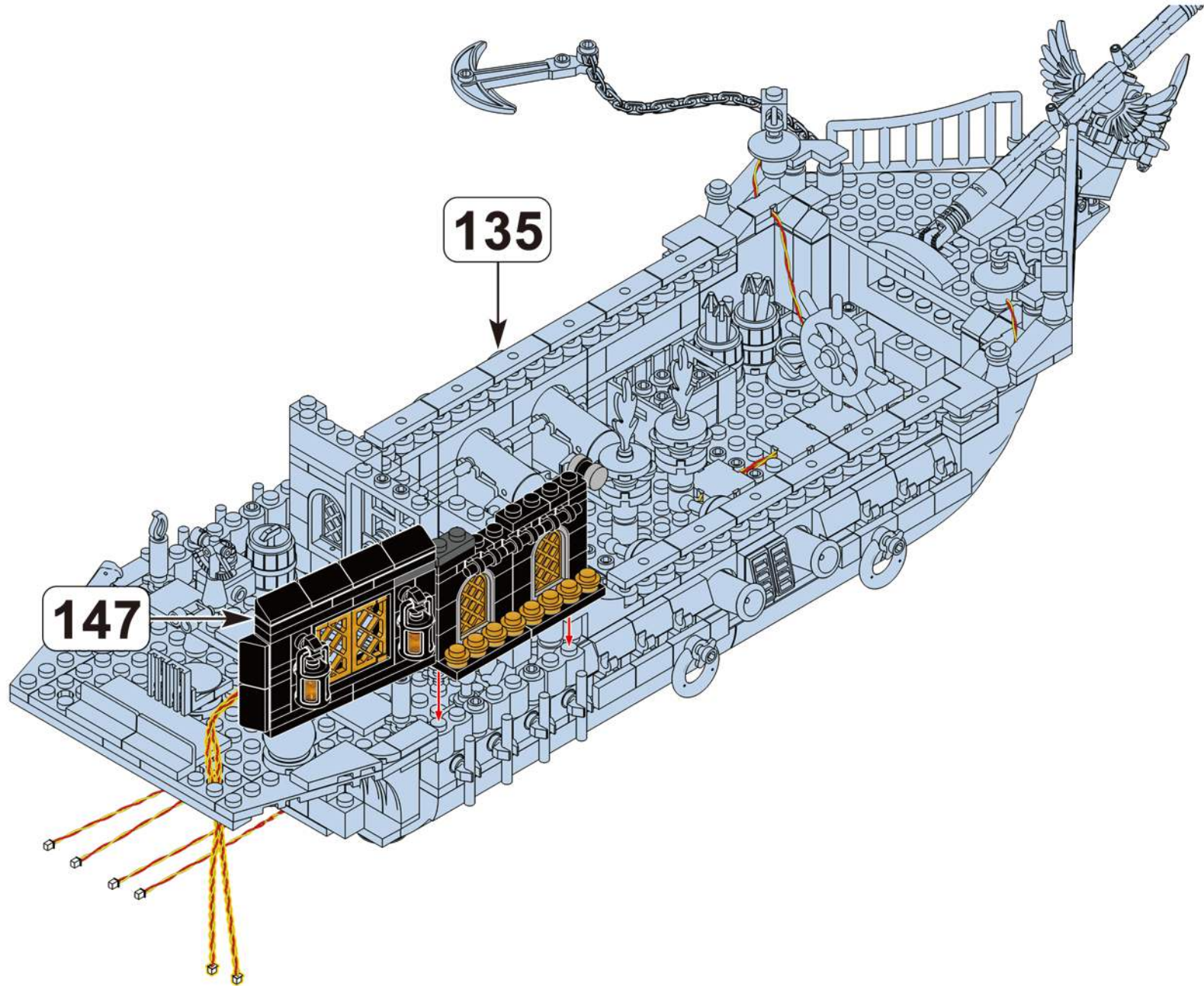

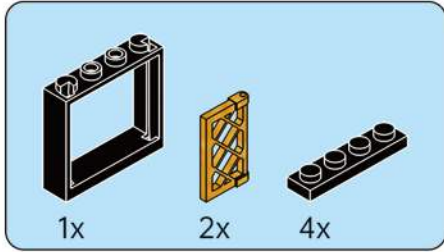

149

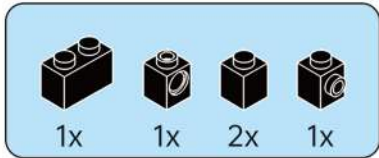
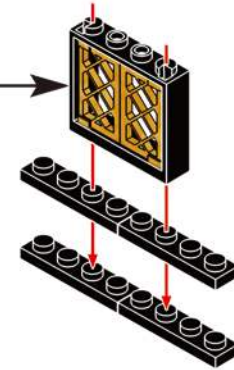
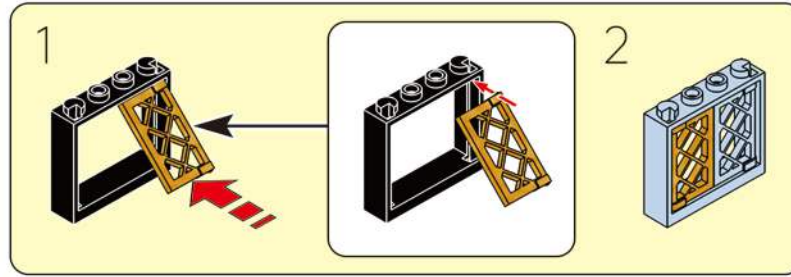

150

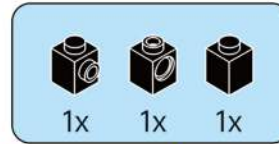
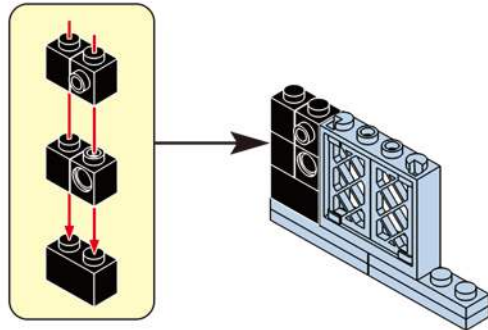

151

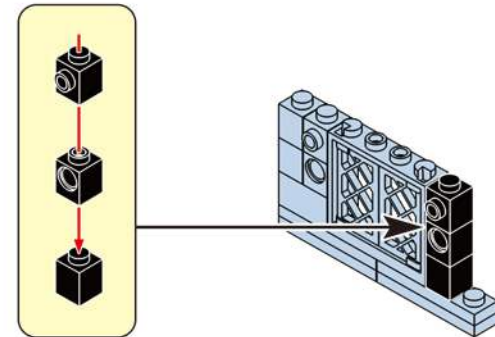

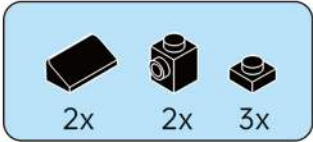

152

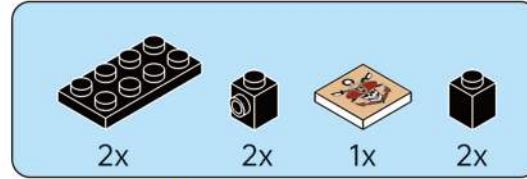
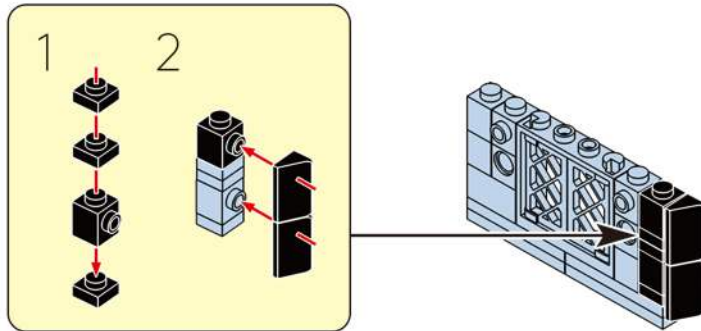

153

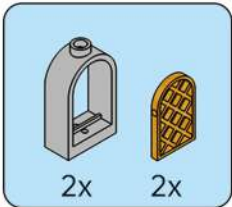
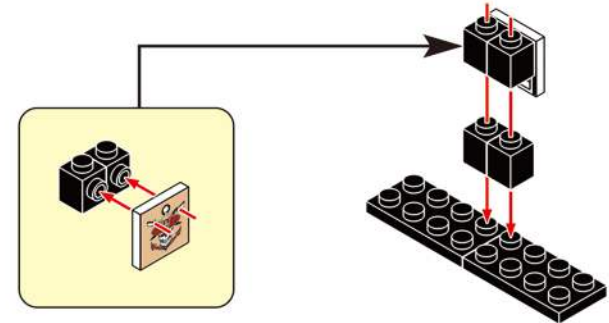

154

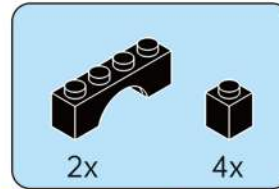
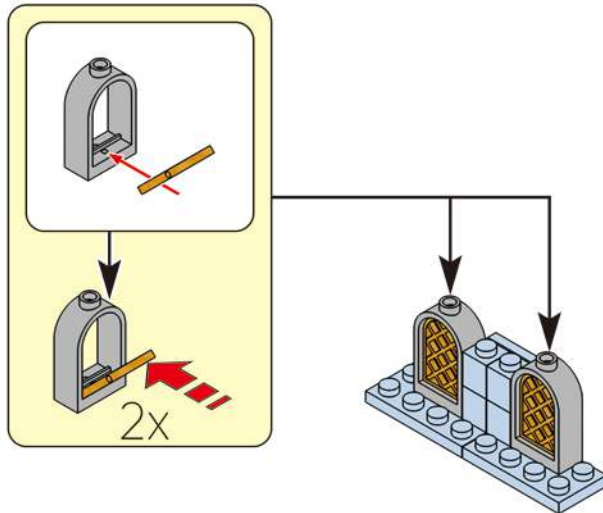

155

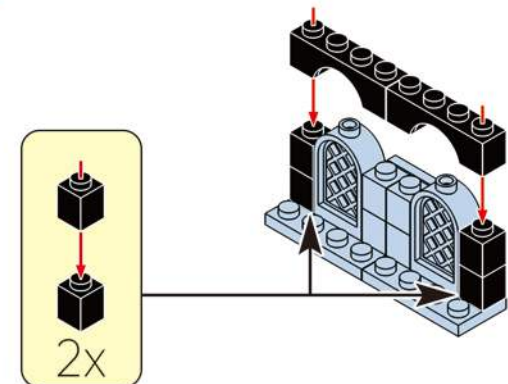



**156**

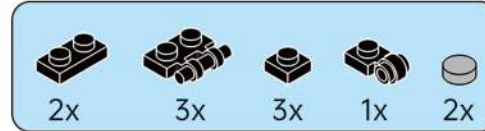
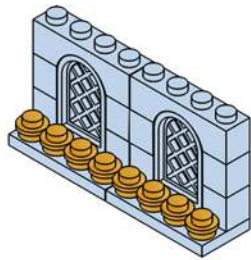

**157**

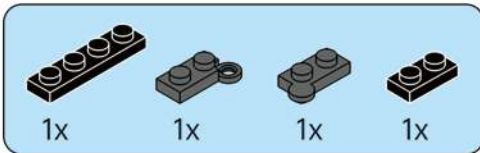
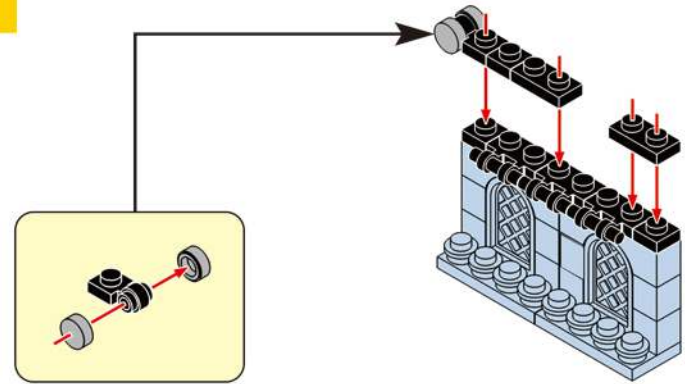

**158**

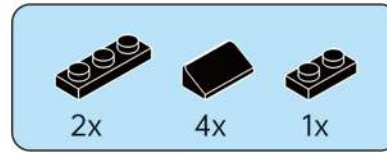
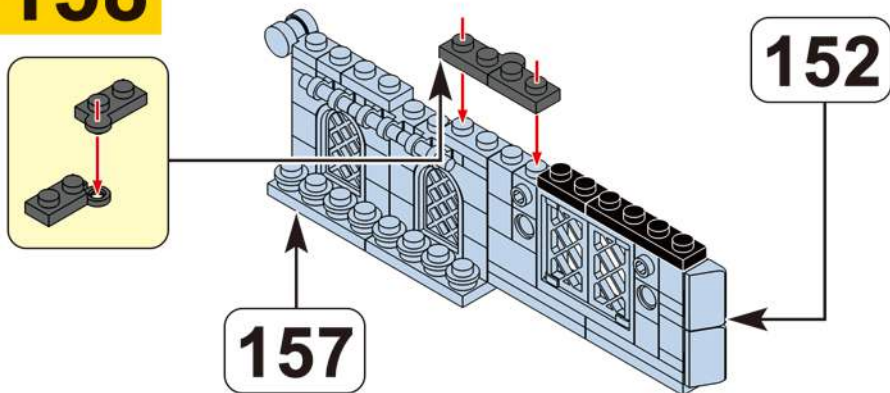

**159**

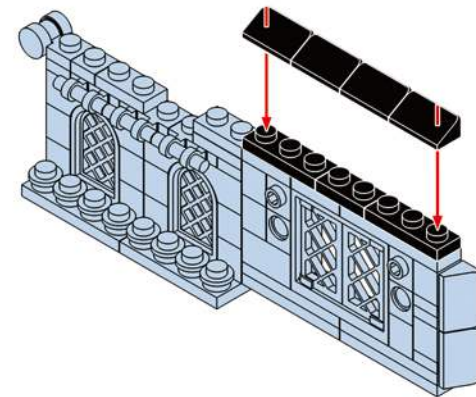

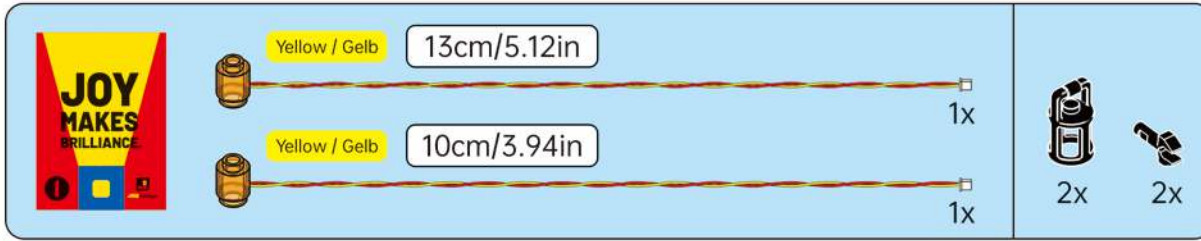

JOY MAKES BRILLIANCE

Yellow / Gelb 13cm/5.12in 1x

Yellow / Gelb 10cm/3.94in 1x

2x 2x

**160**

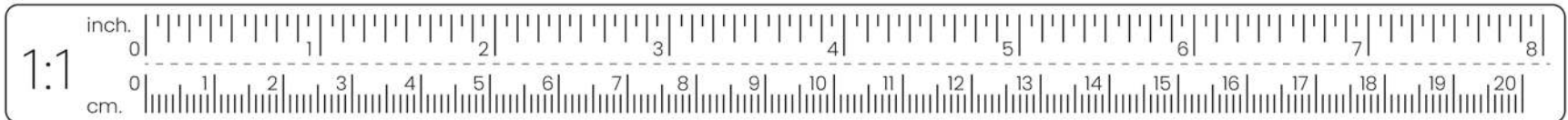
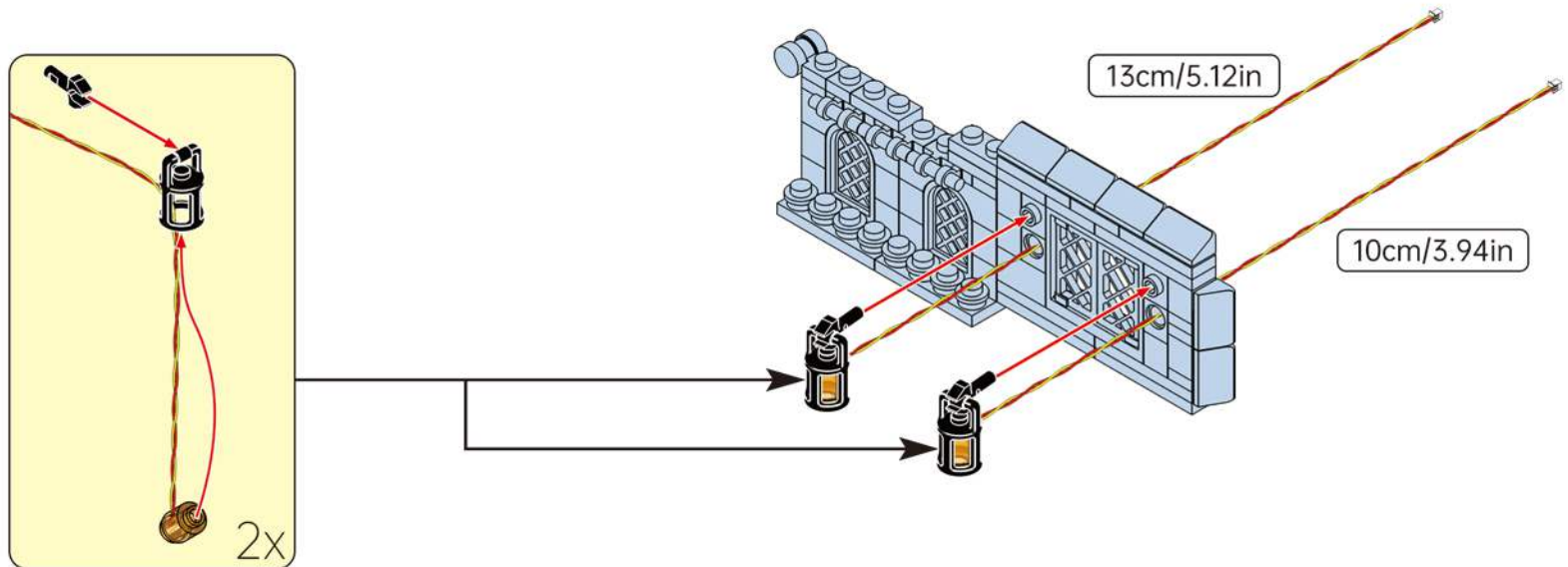

161

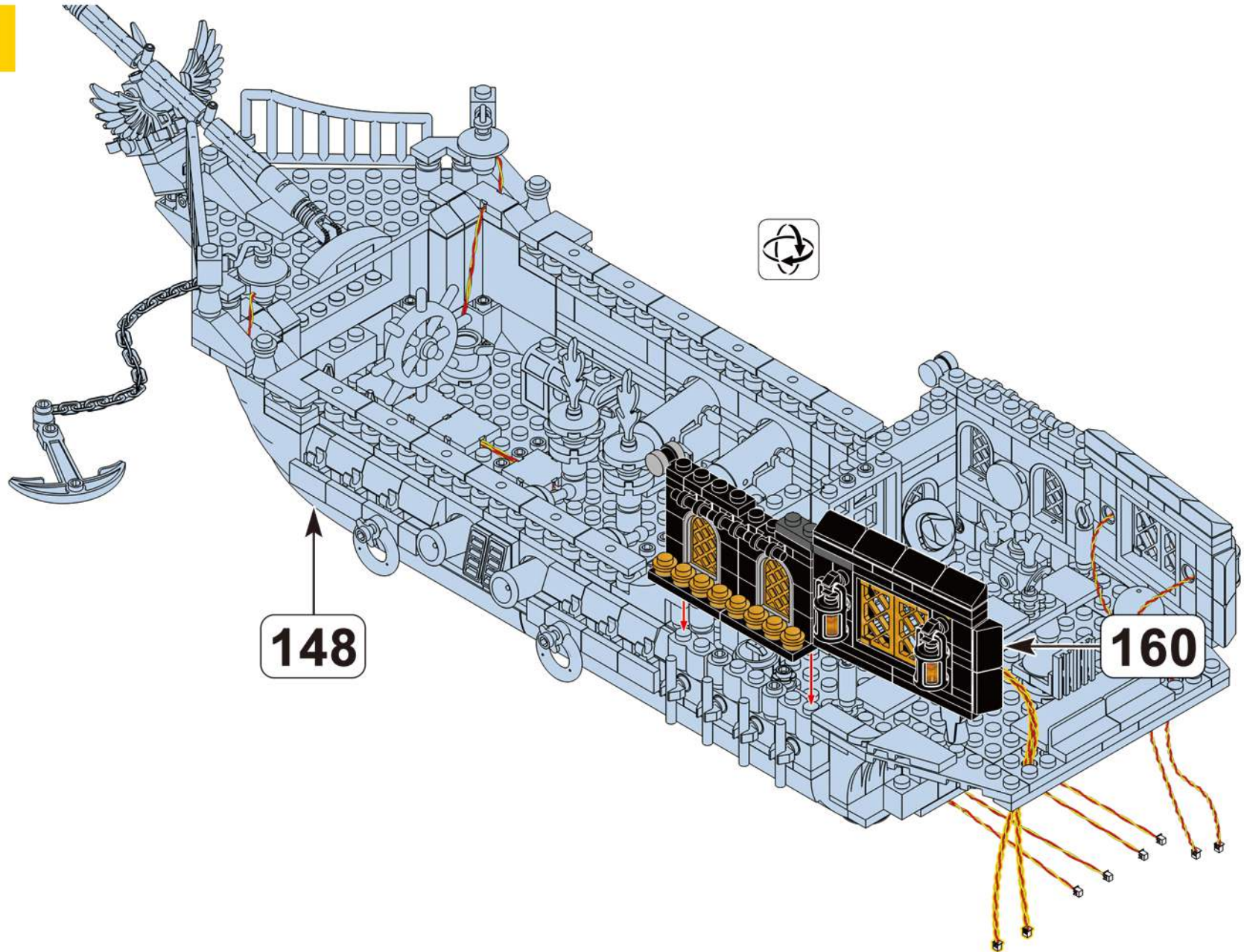

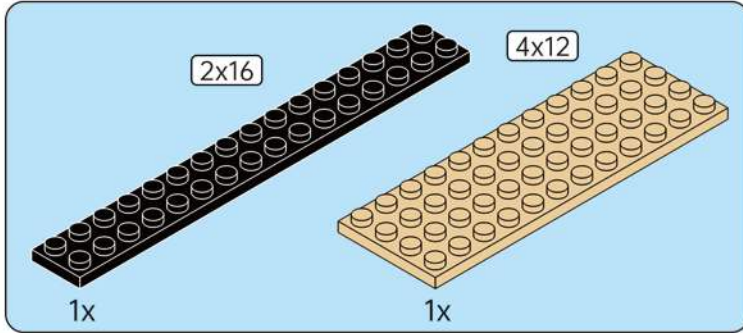

162

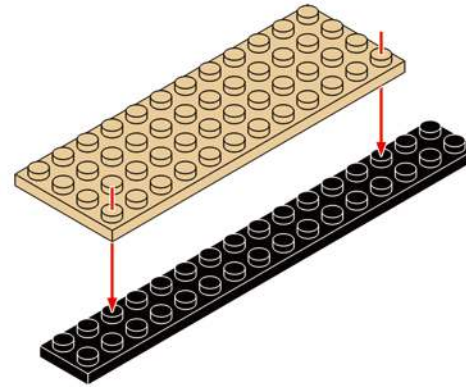

163

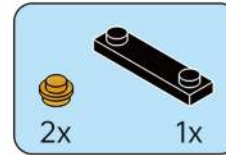
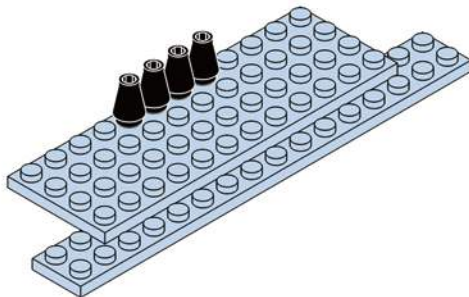

164

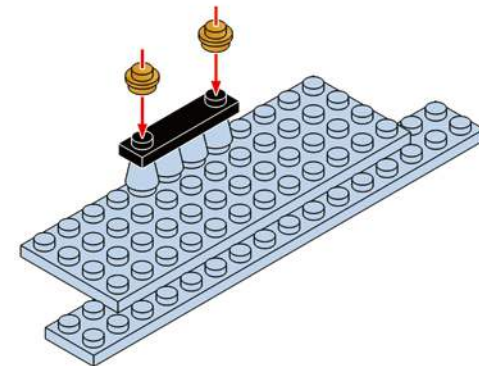

165

161

164

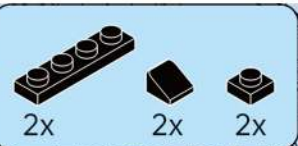
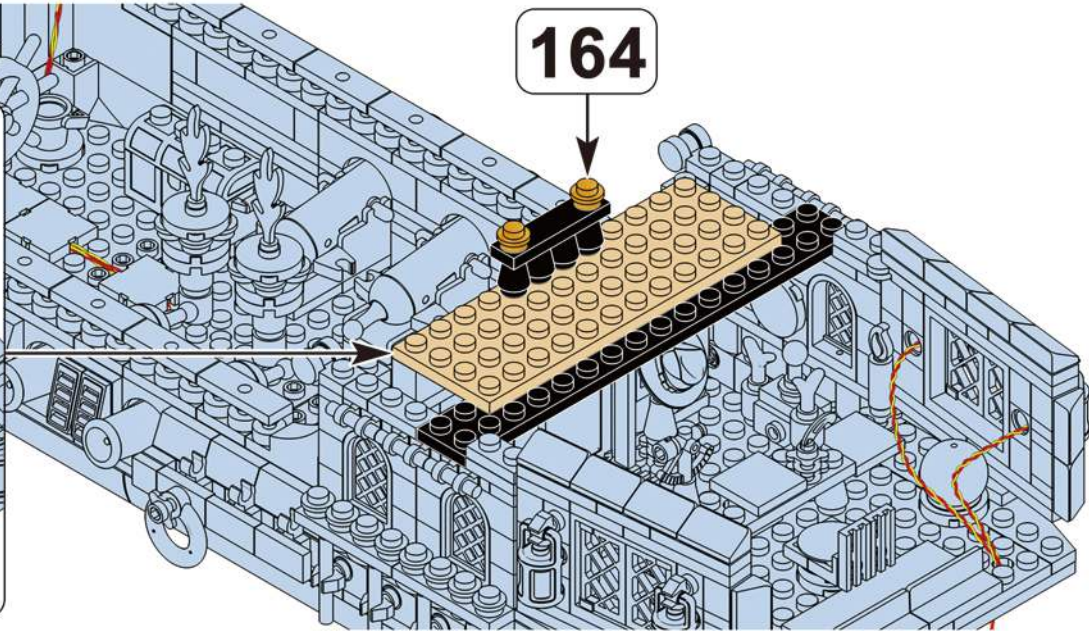
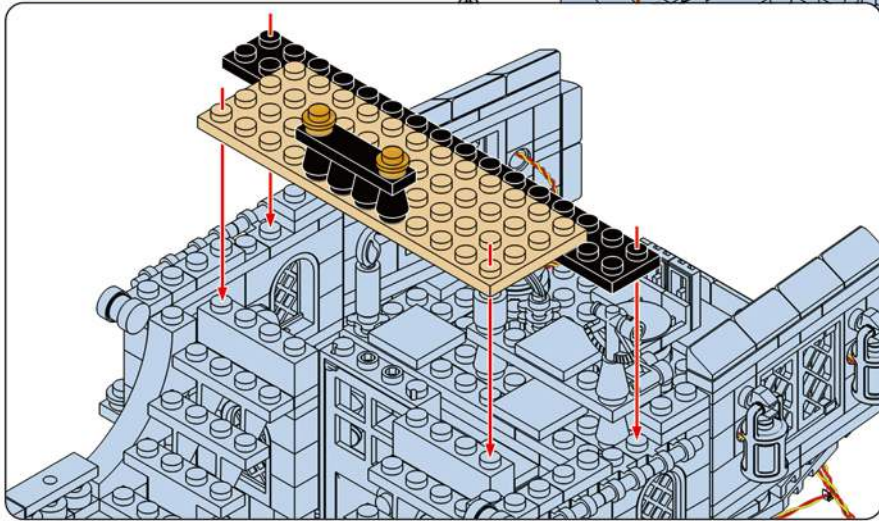

166

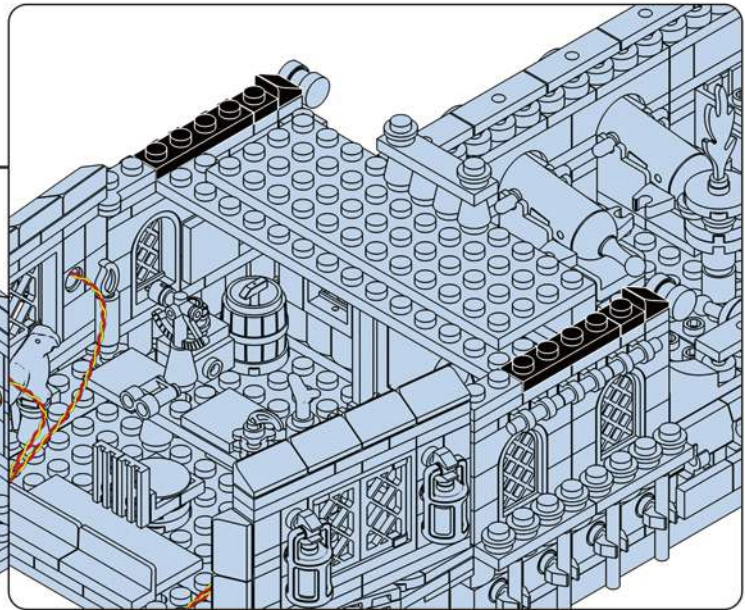
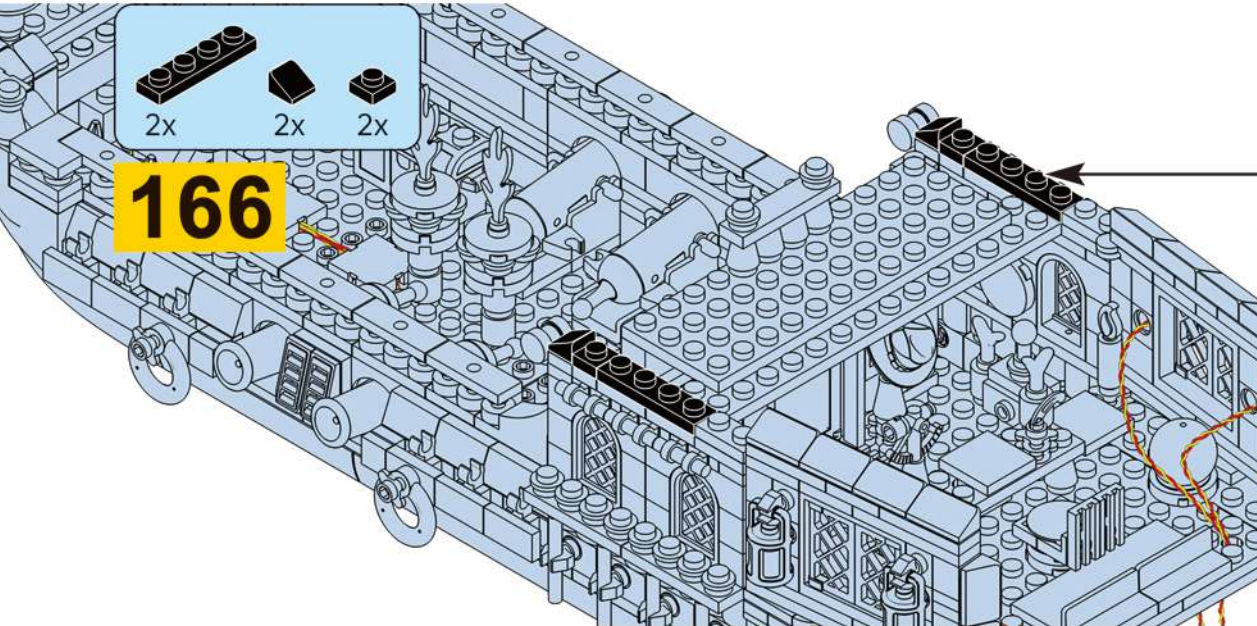

1x3  
2x 2x 2x

167

2x

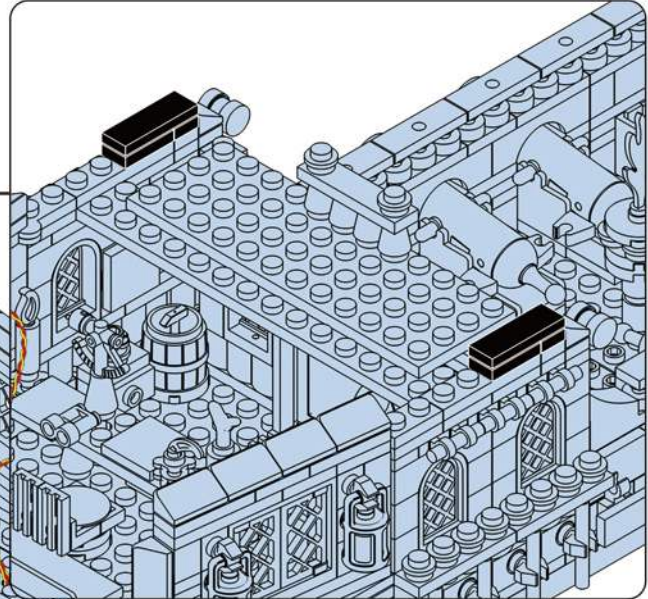
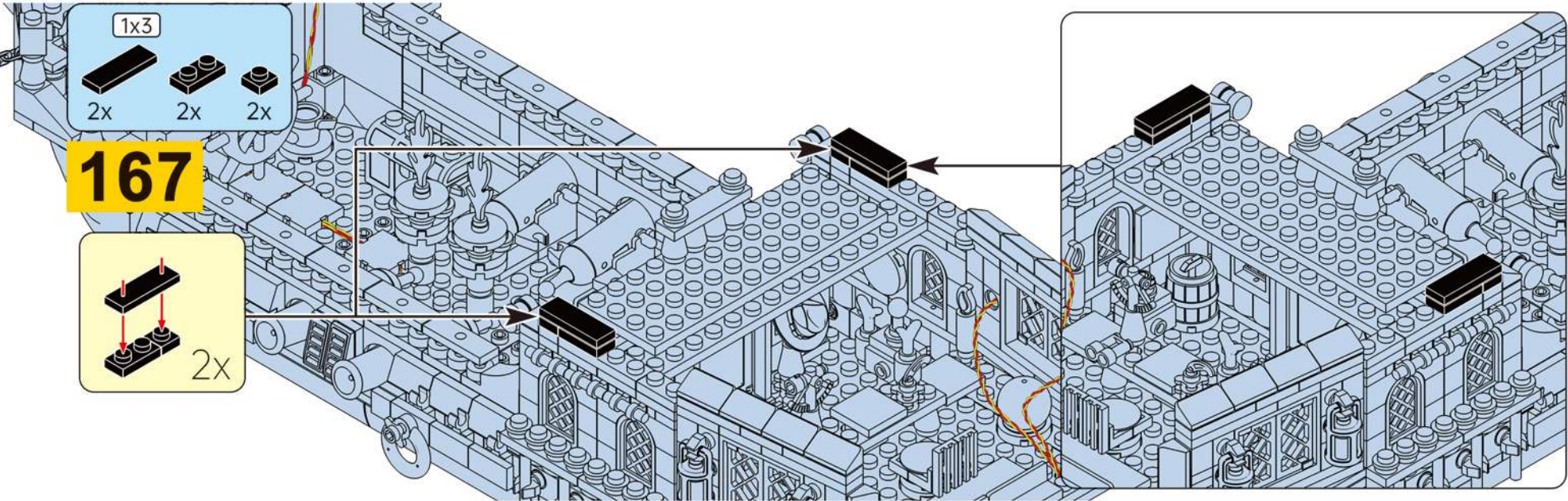

2x 4x

168

2x

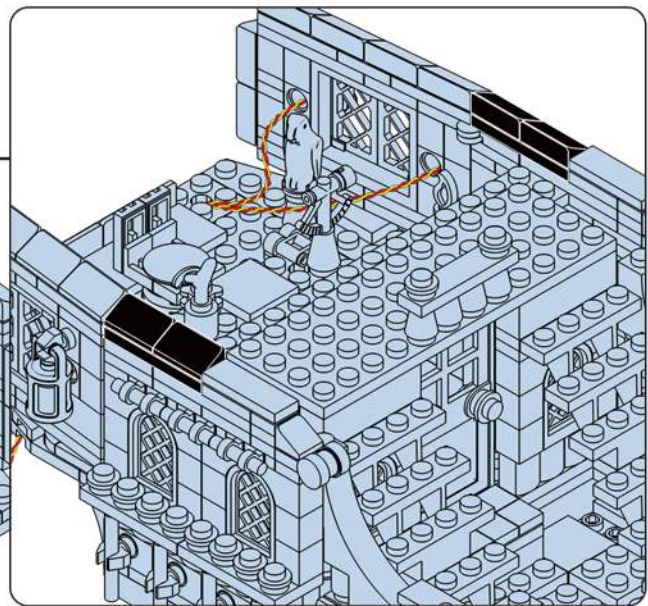
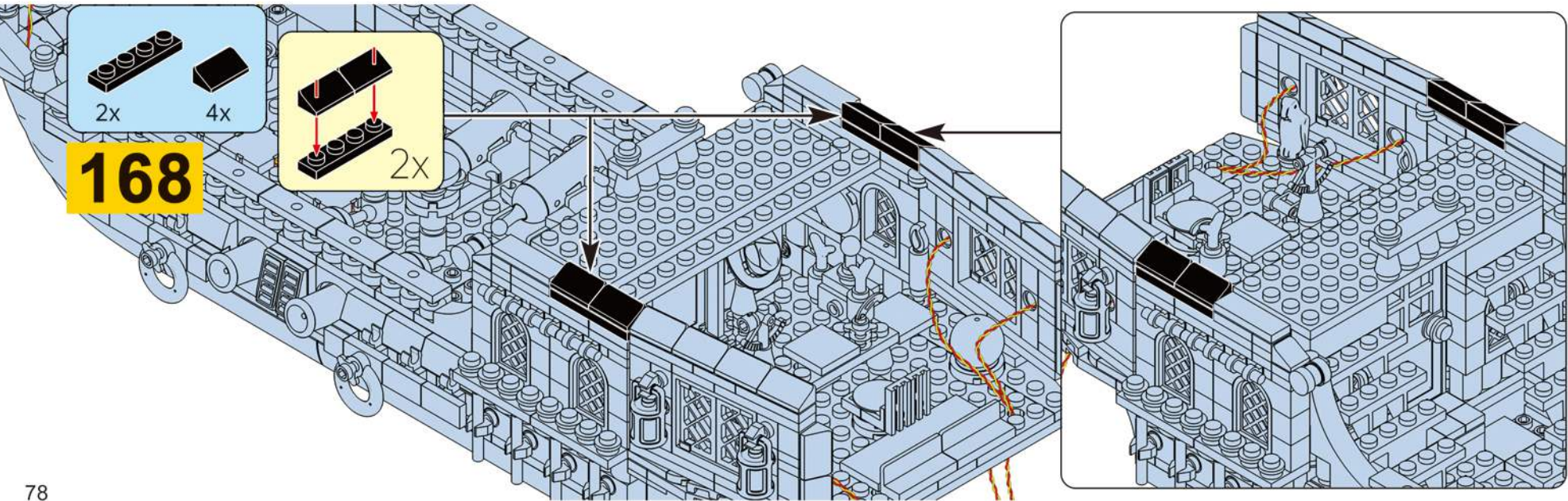

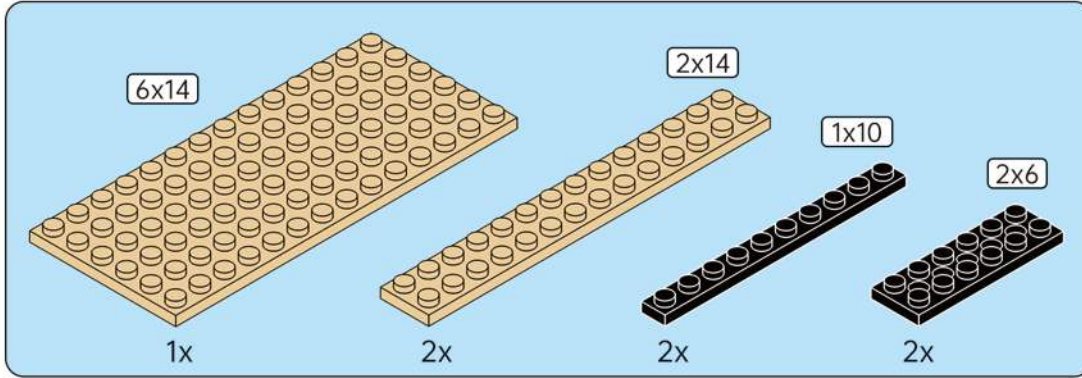



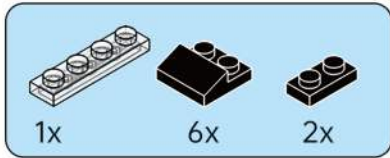
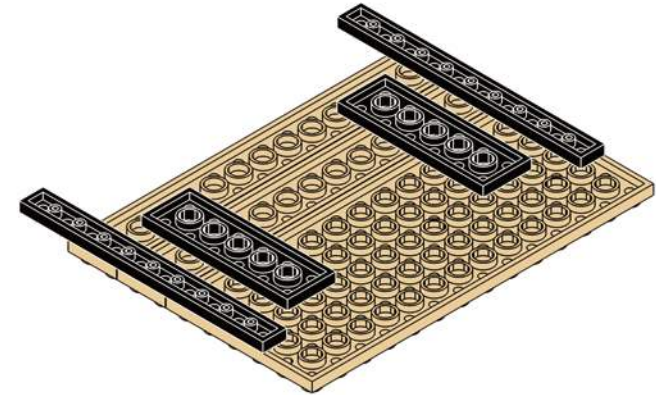

169

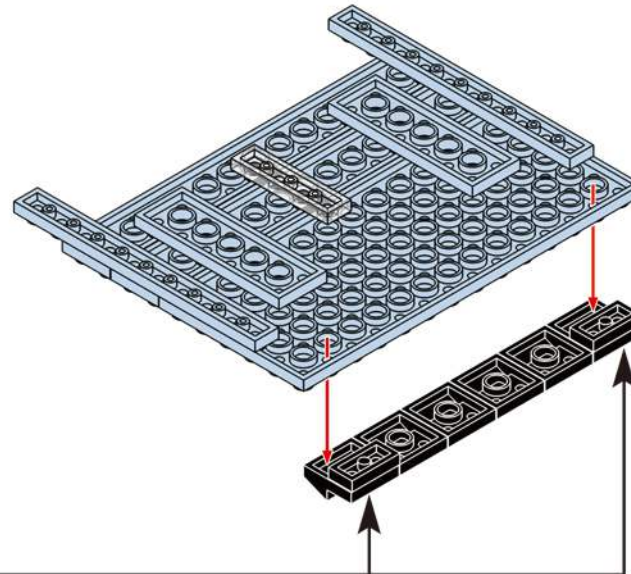
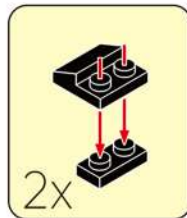

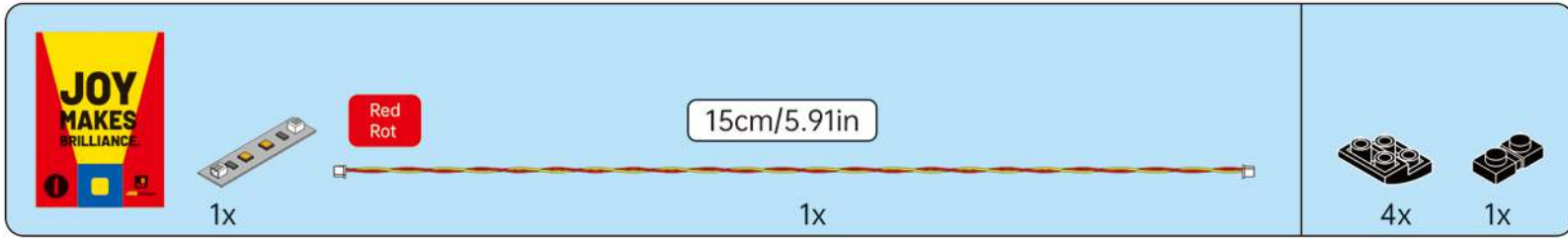
170



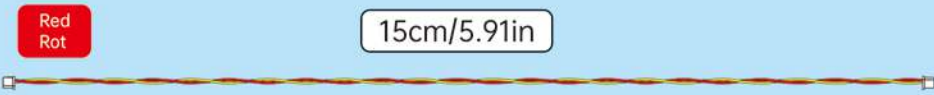

1x  1x  15cm/5.91in 4x  1x 

# 171

Tear off the double-sided tape for pasting. Reiß Sie das doppelseitige Klebeband zum Aufkleben ab

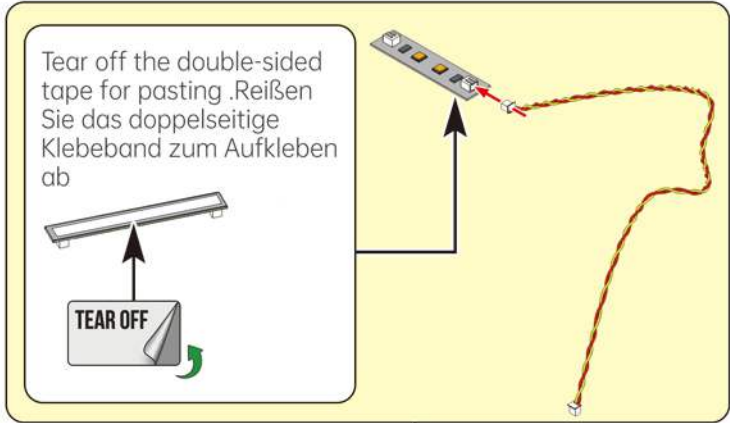

TEAR OFF

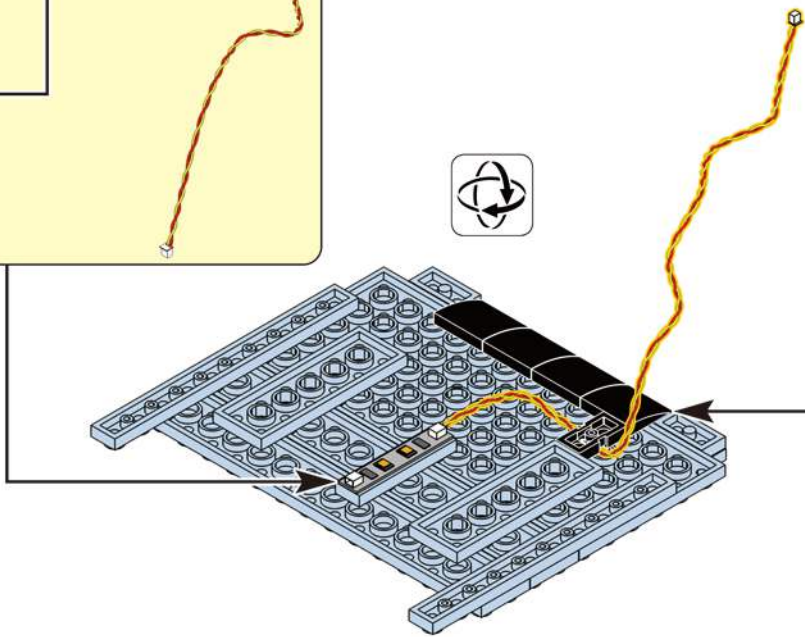

3

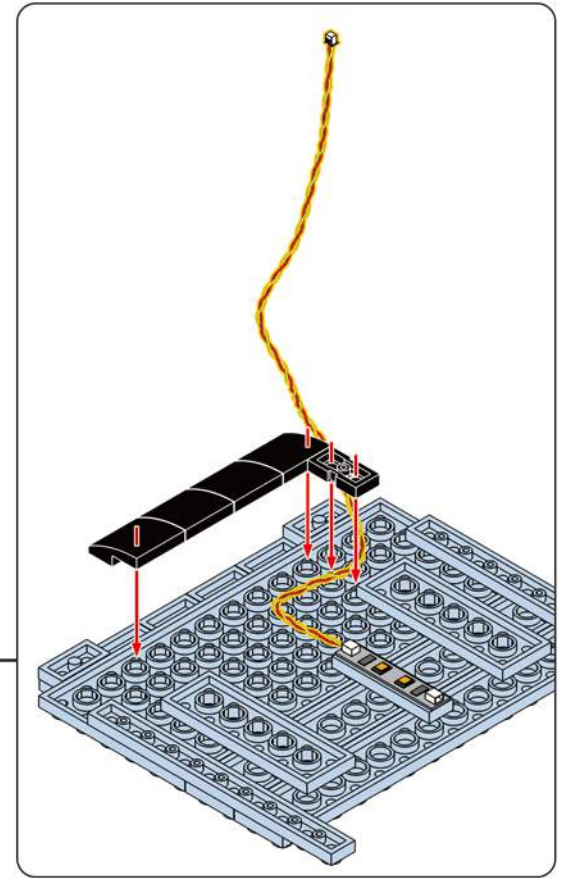
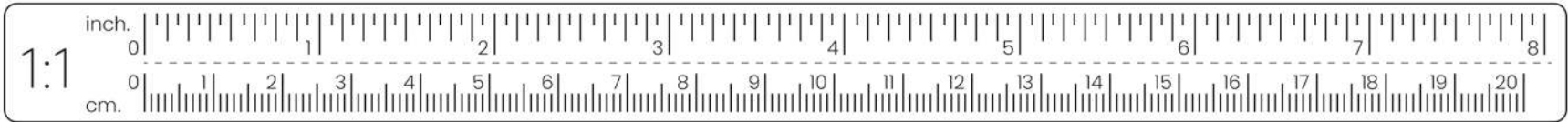

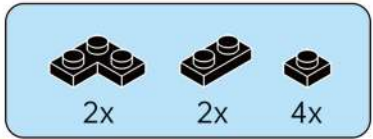

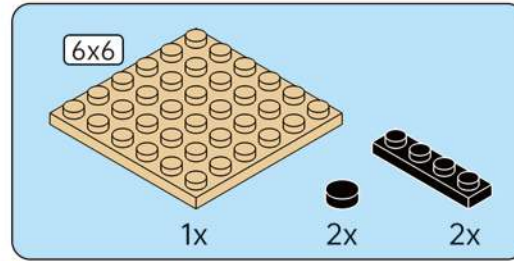
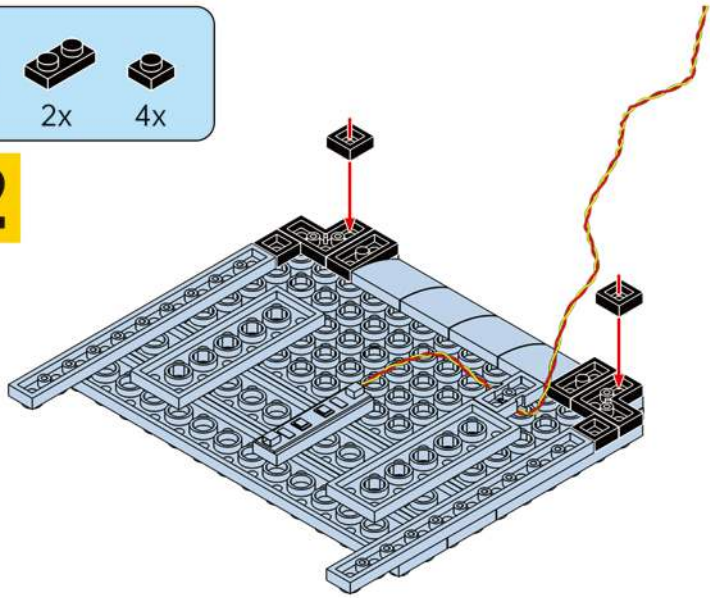

172

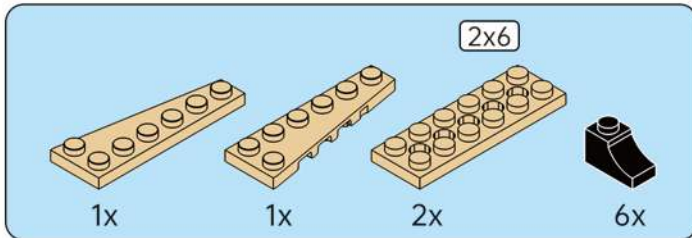
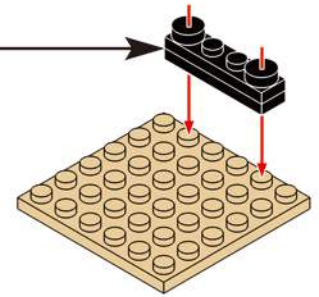
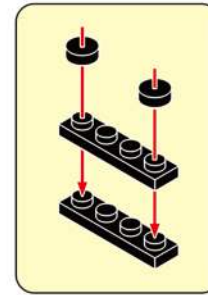

173



174

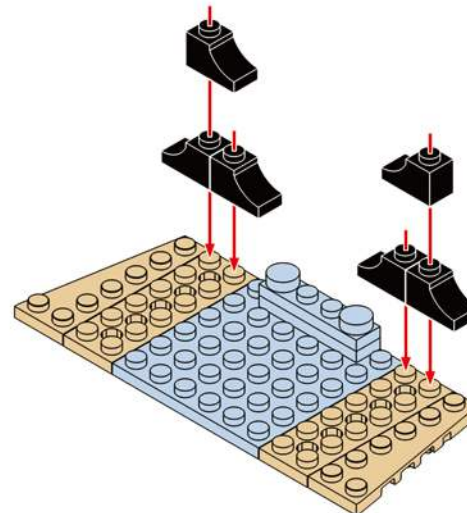

**JOY MAKES BRILLIANCE**

Yellow  
Gelb

20cm/7.87in

2x

2x 2x 2x

175

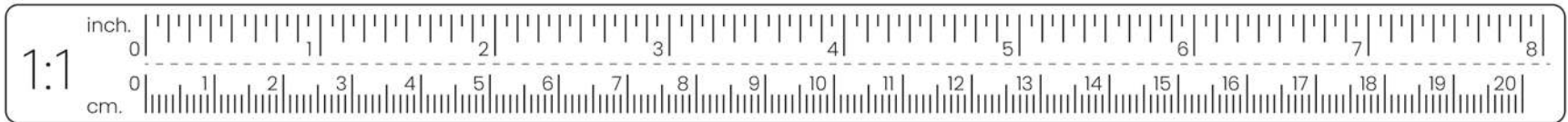
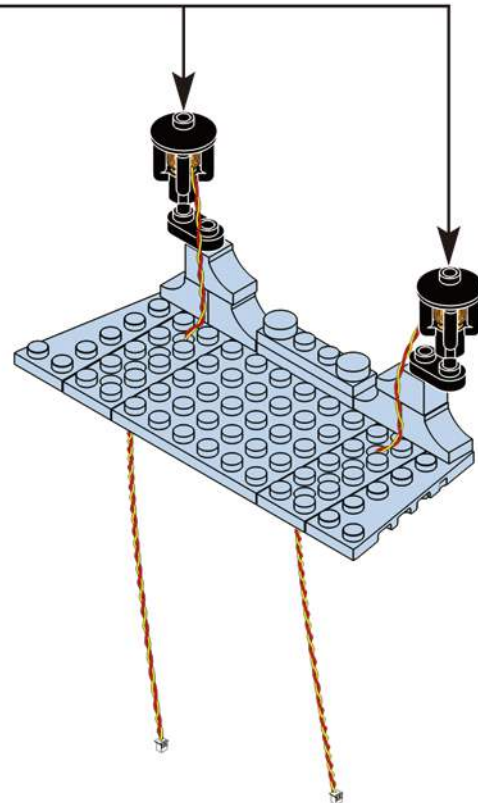
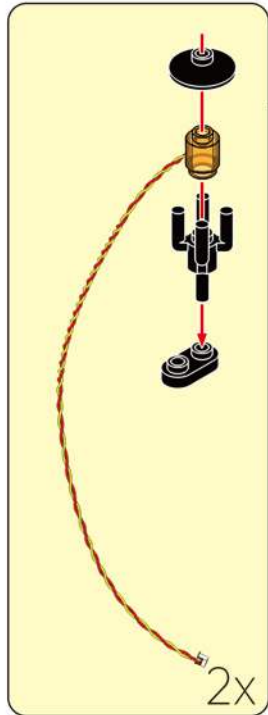

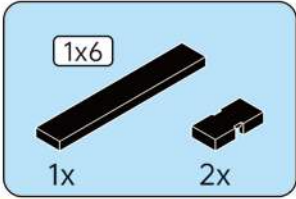

176

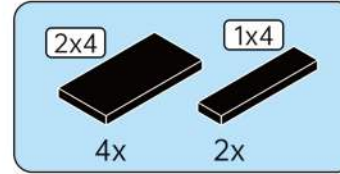
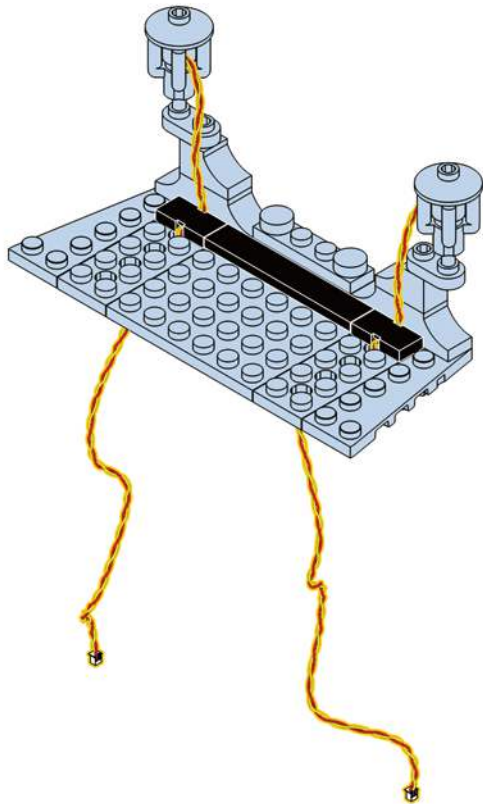

177

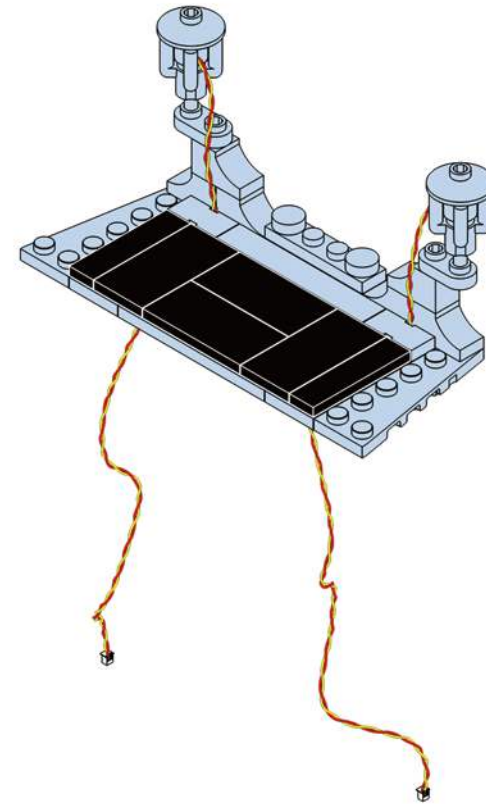

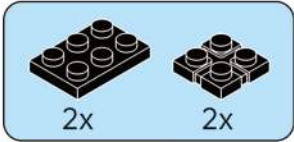

# 178

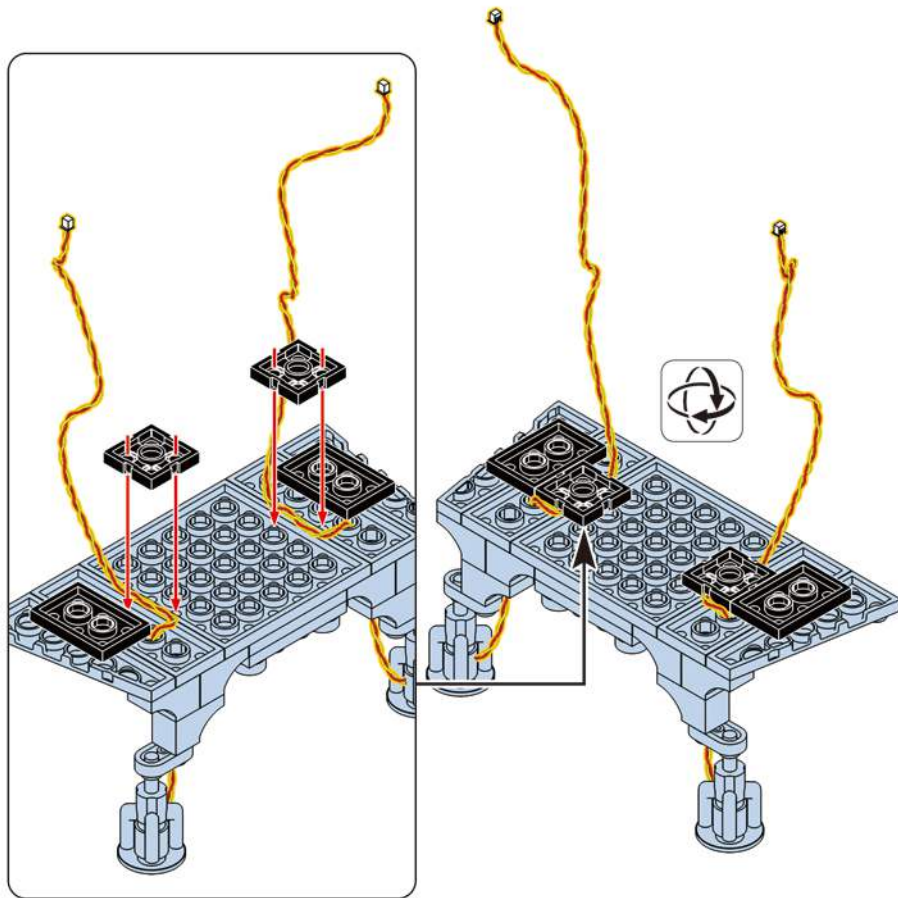

# 179

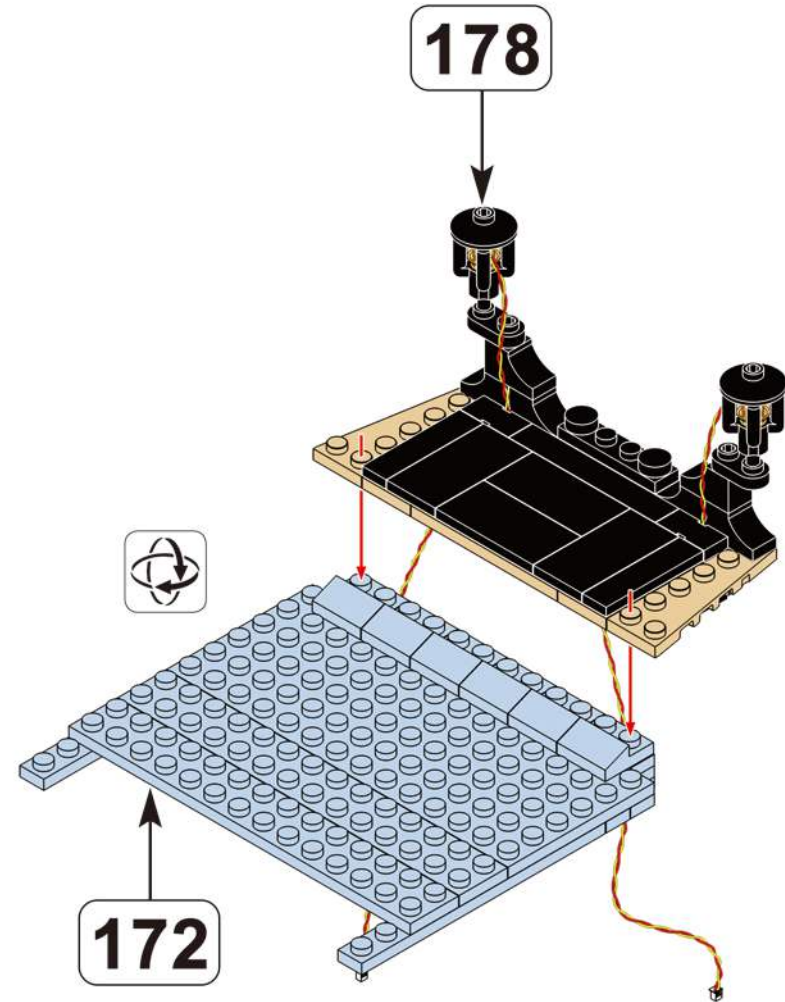

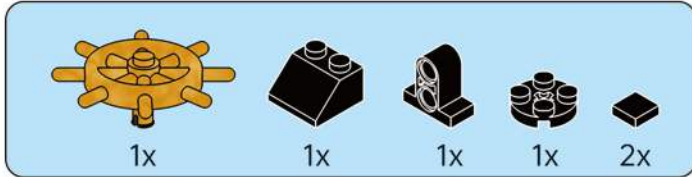

180

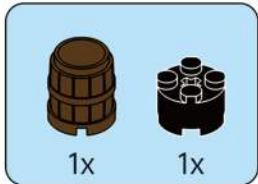
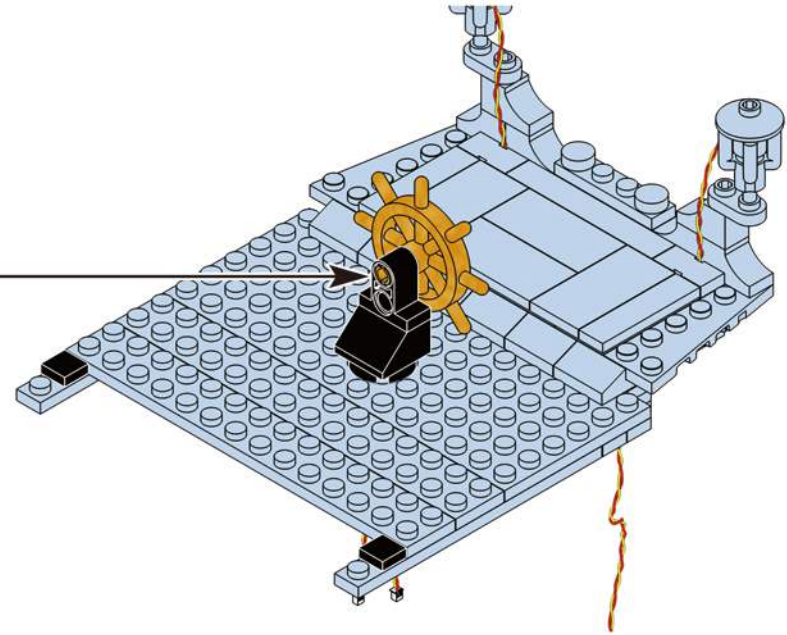
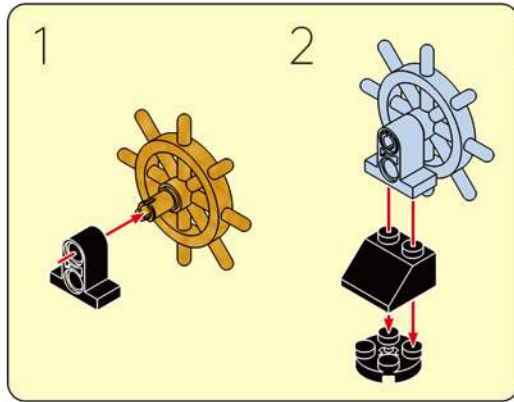

181

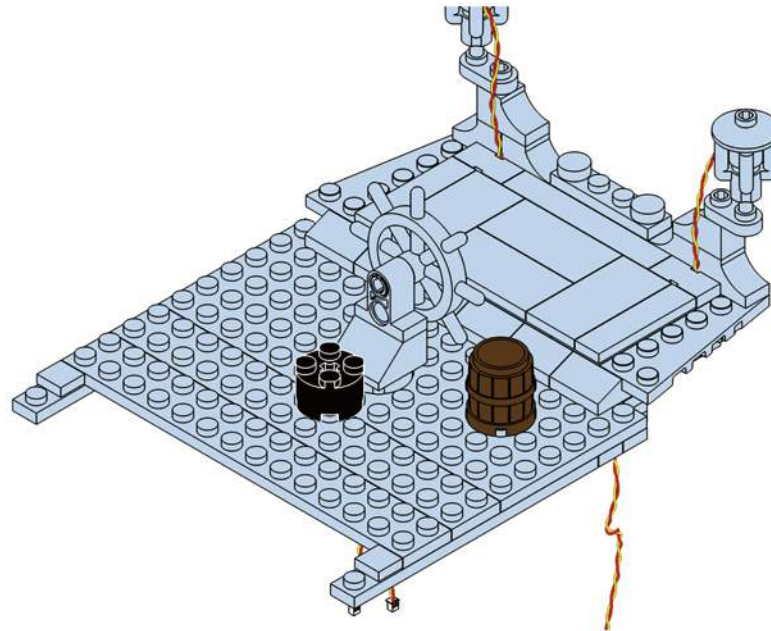

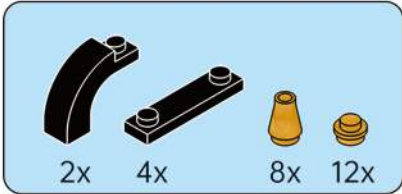

182

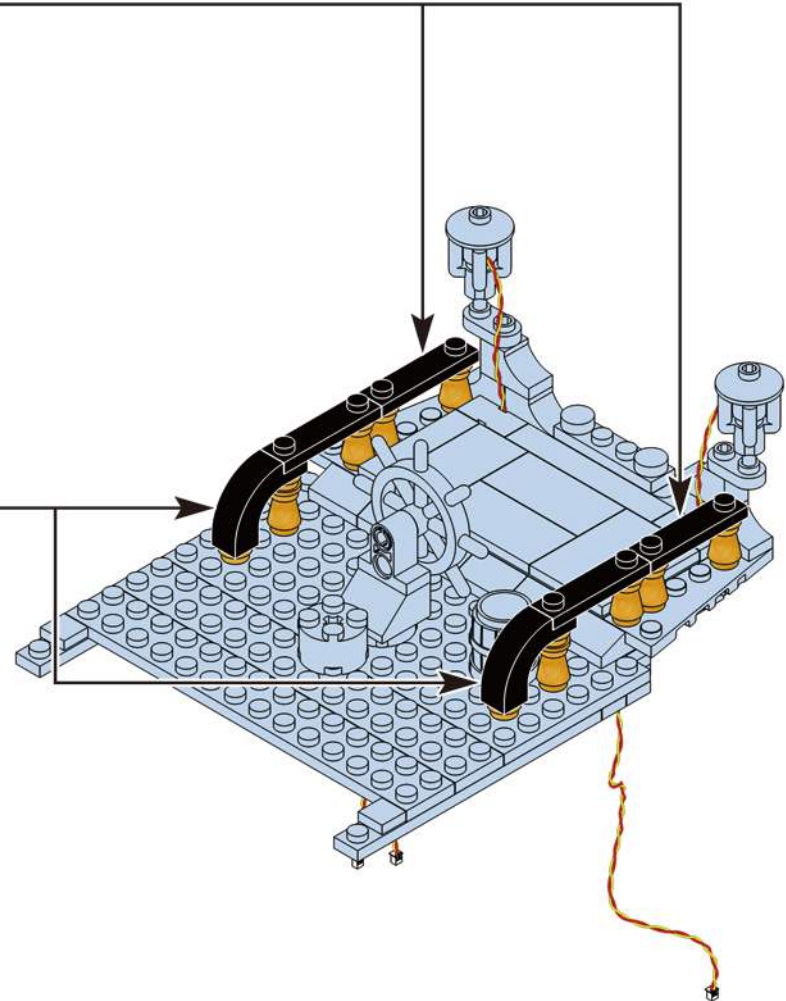
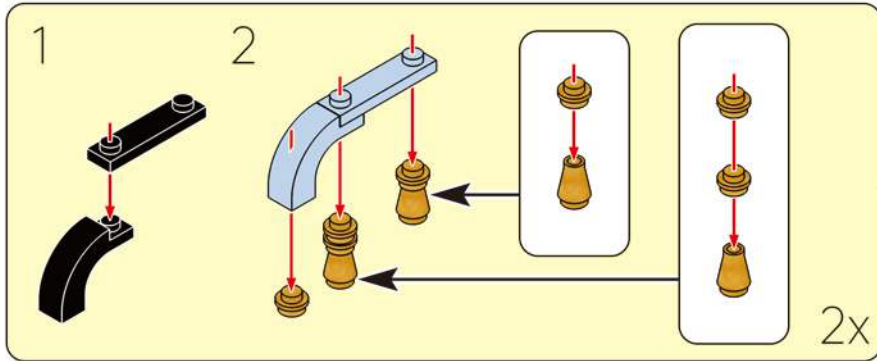
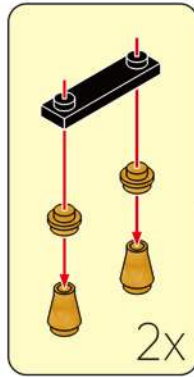

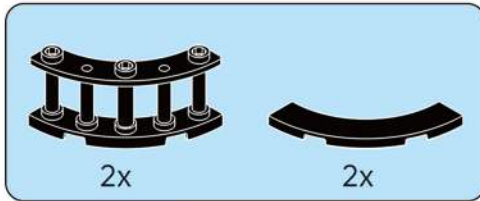

183

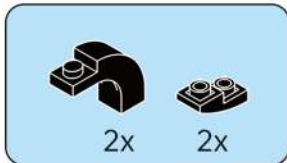
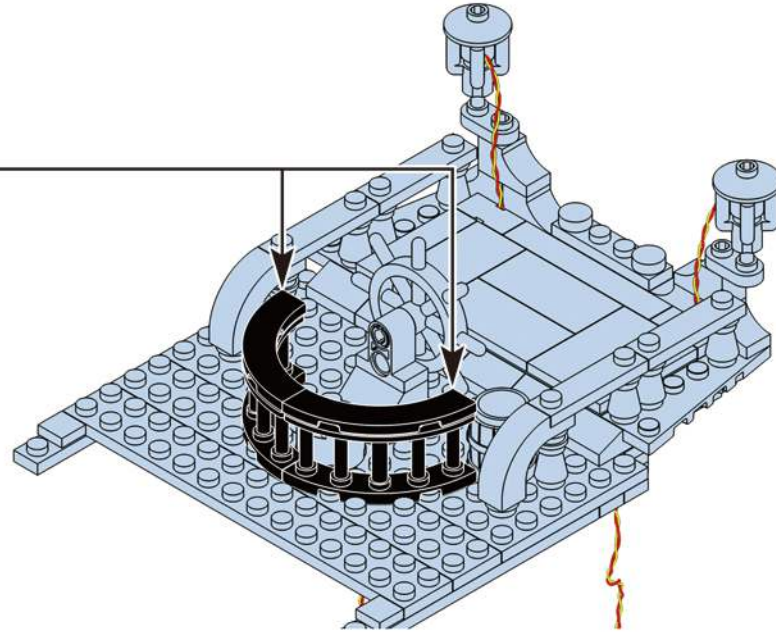
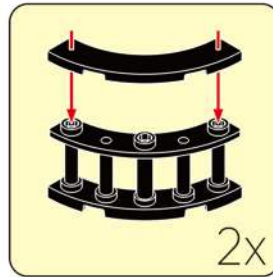

184

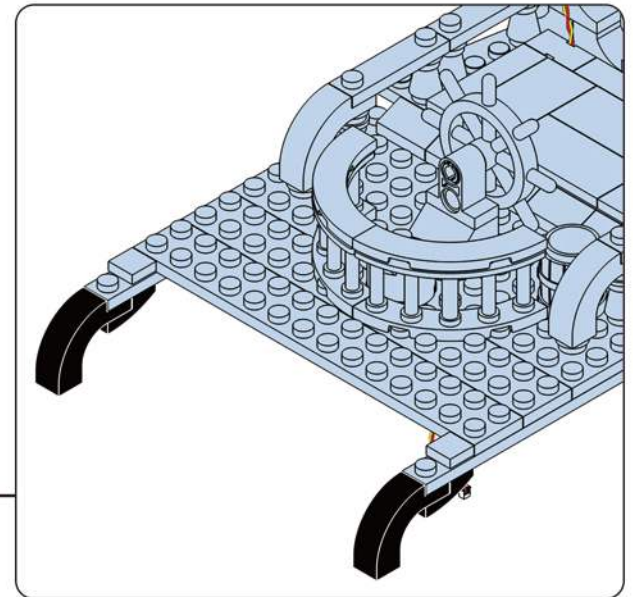
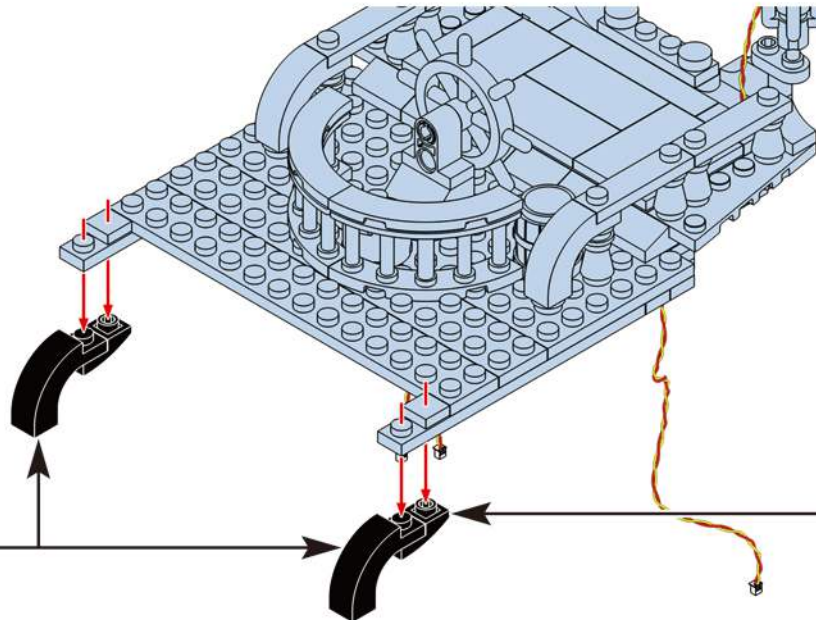
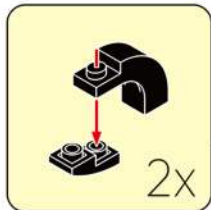

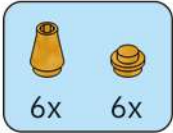

185

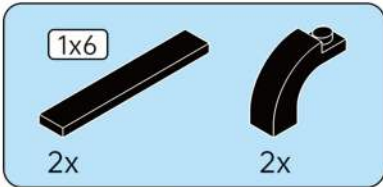
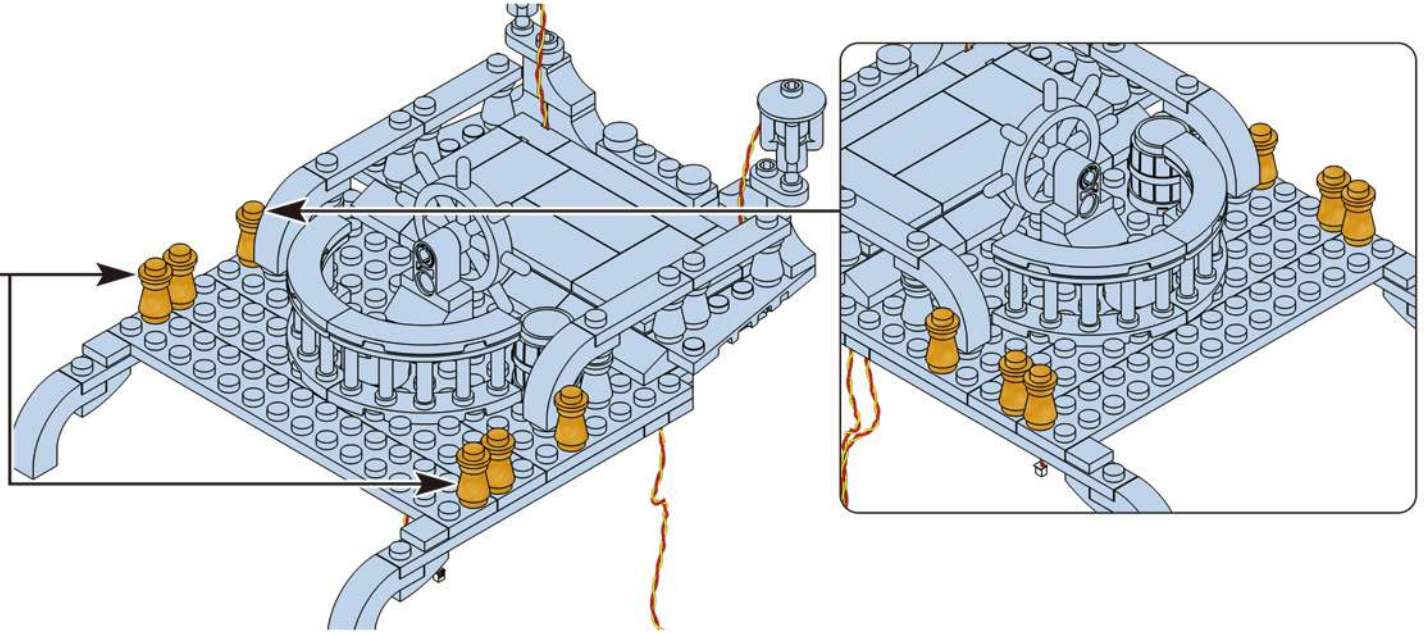
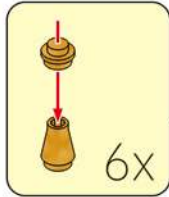

186

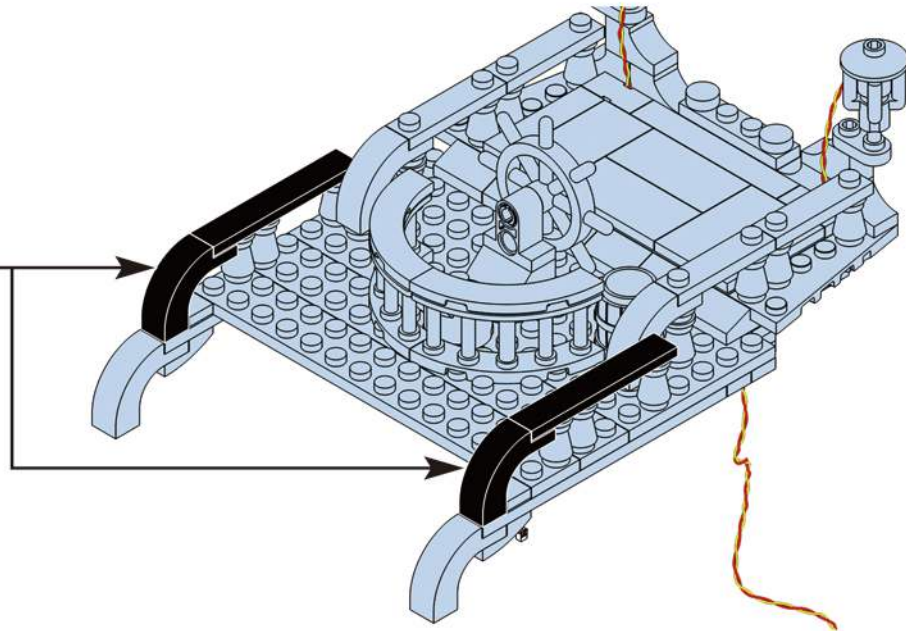
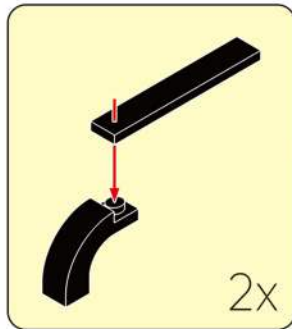

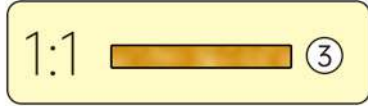
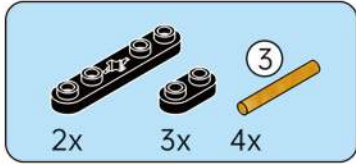

187

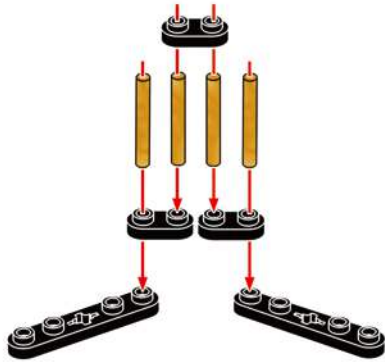

188

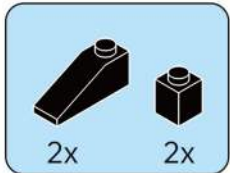
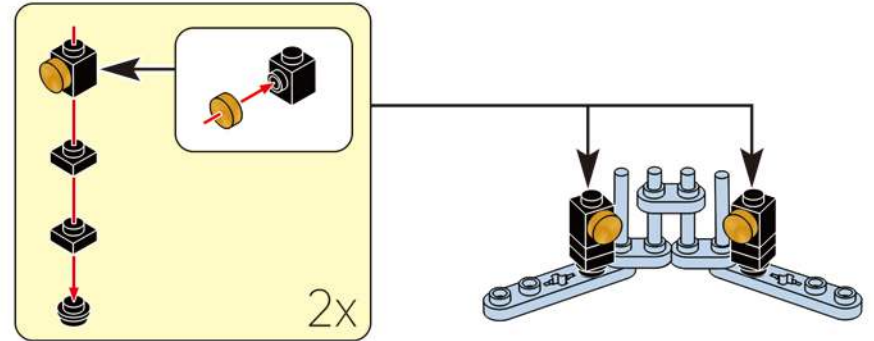

189

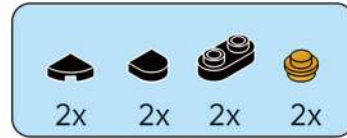
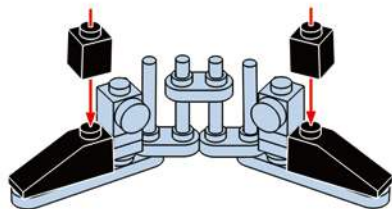

190

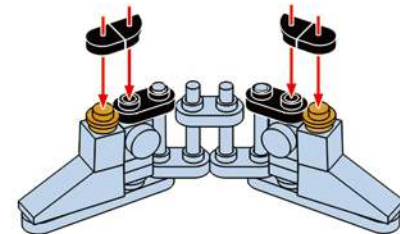

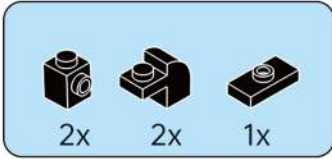

191

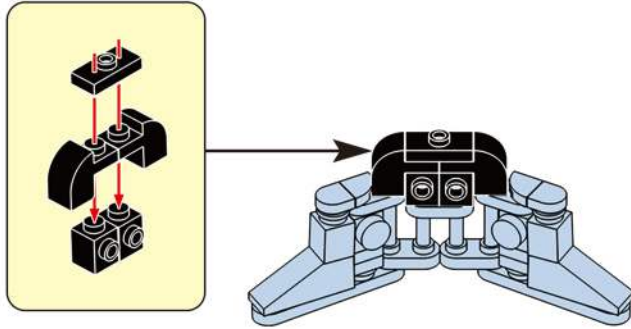

192

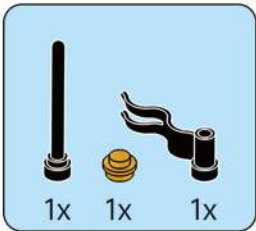
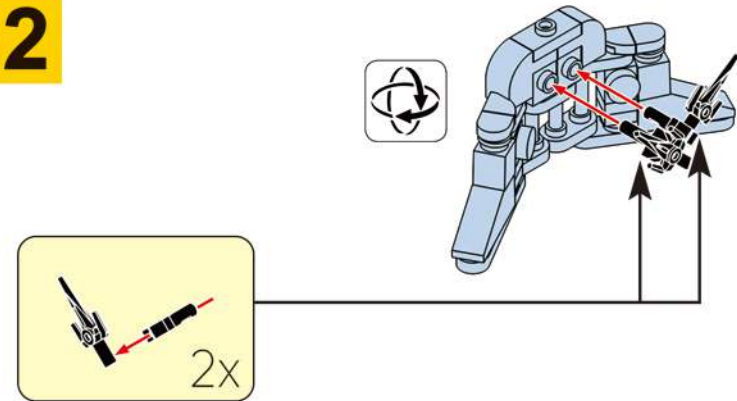

193

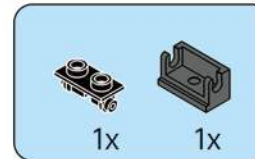
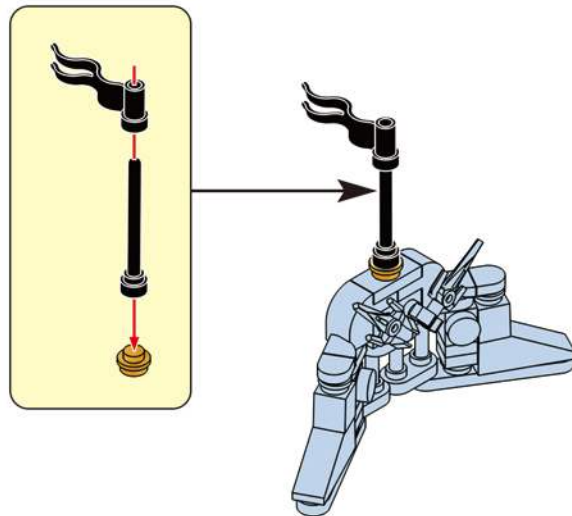

194

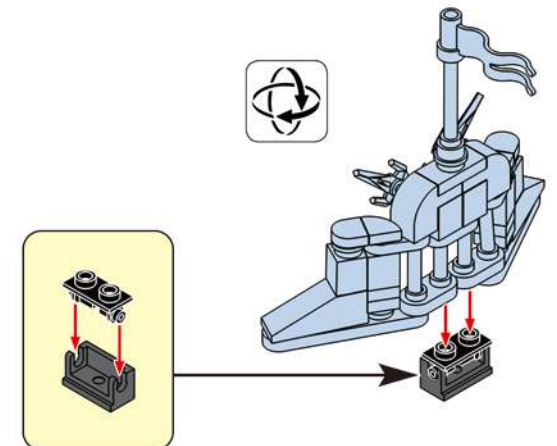

195

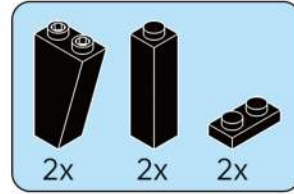
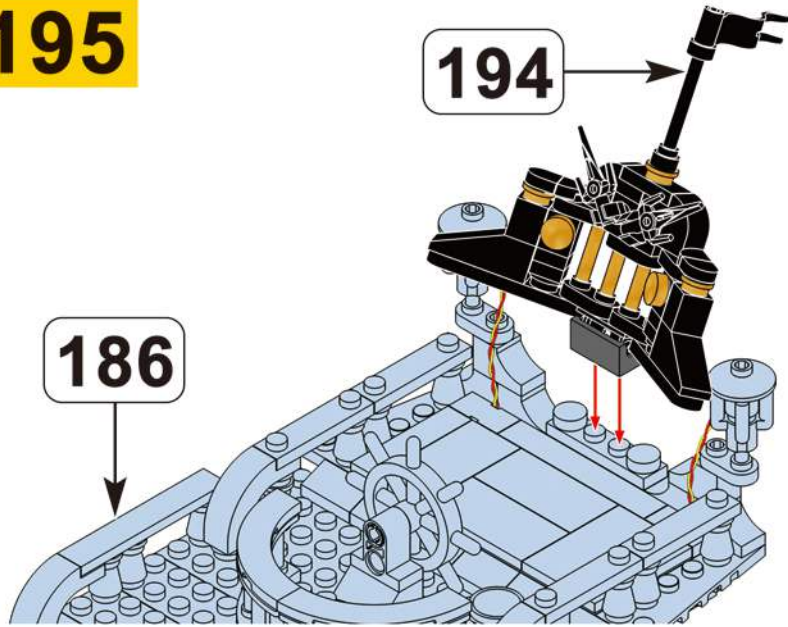

196

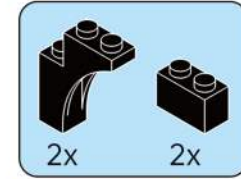
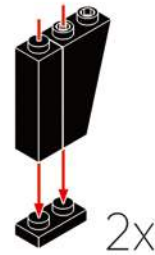

197

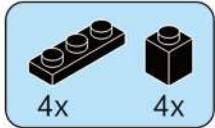
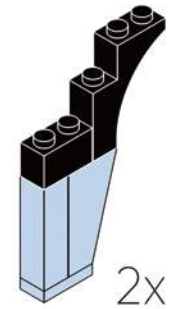

198

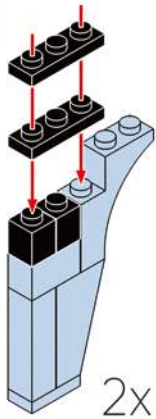

199

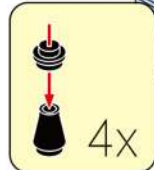

195

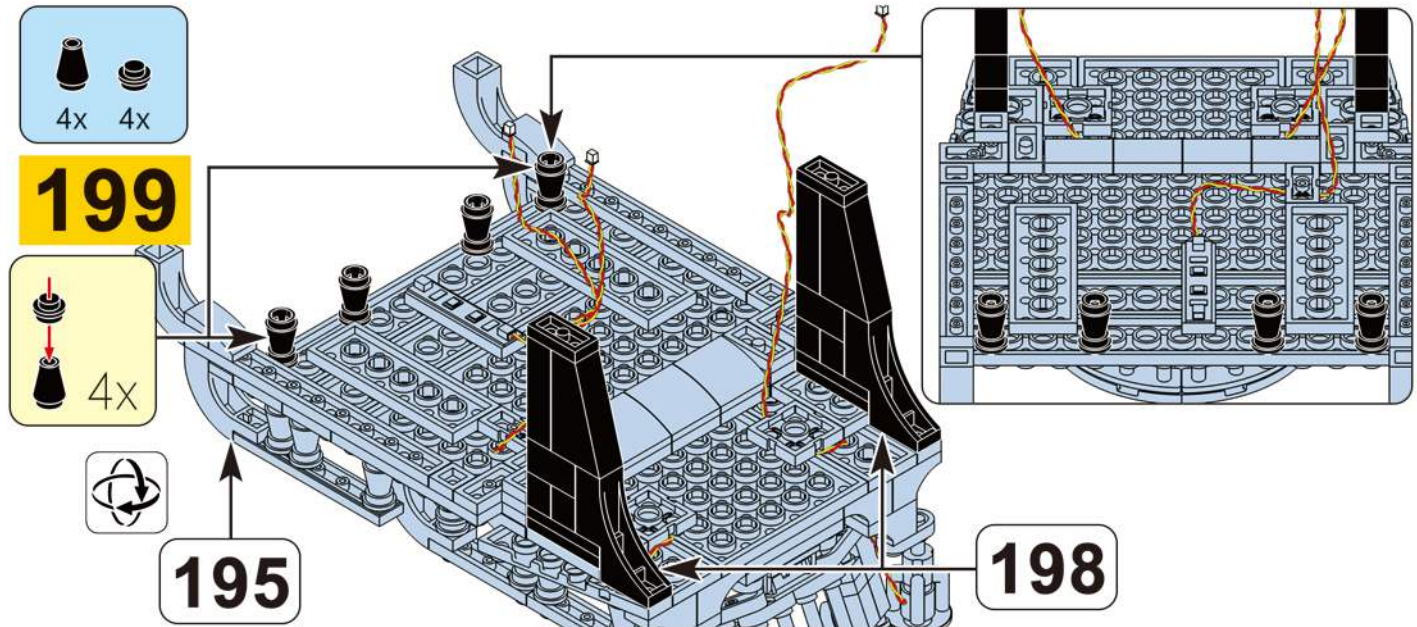

198

200

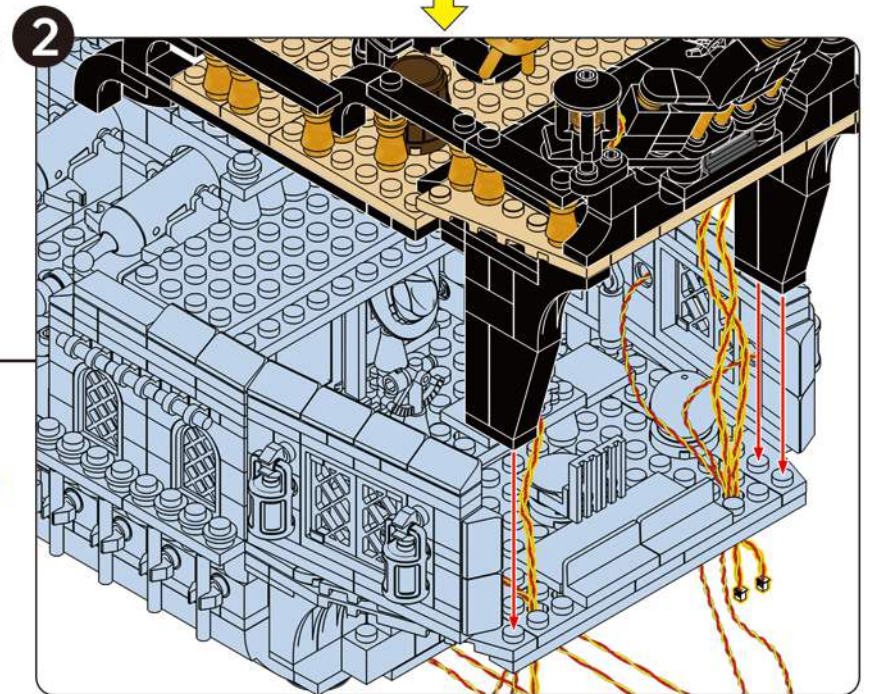
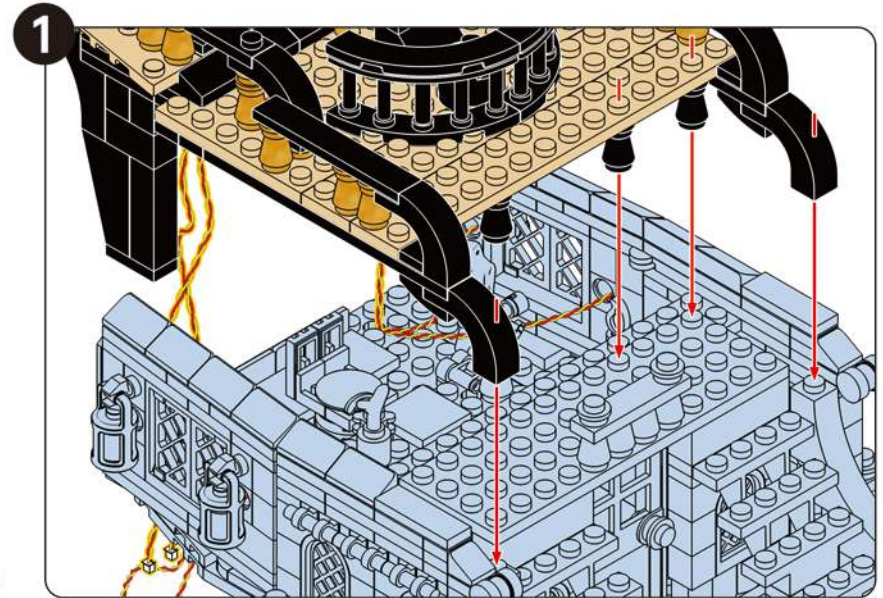
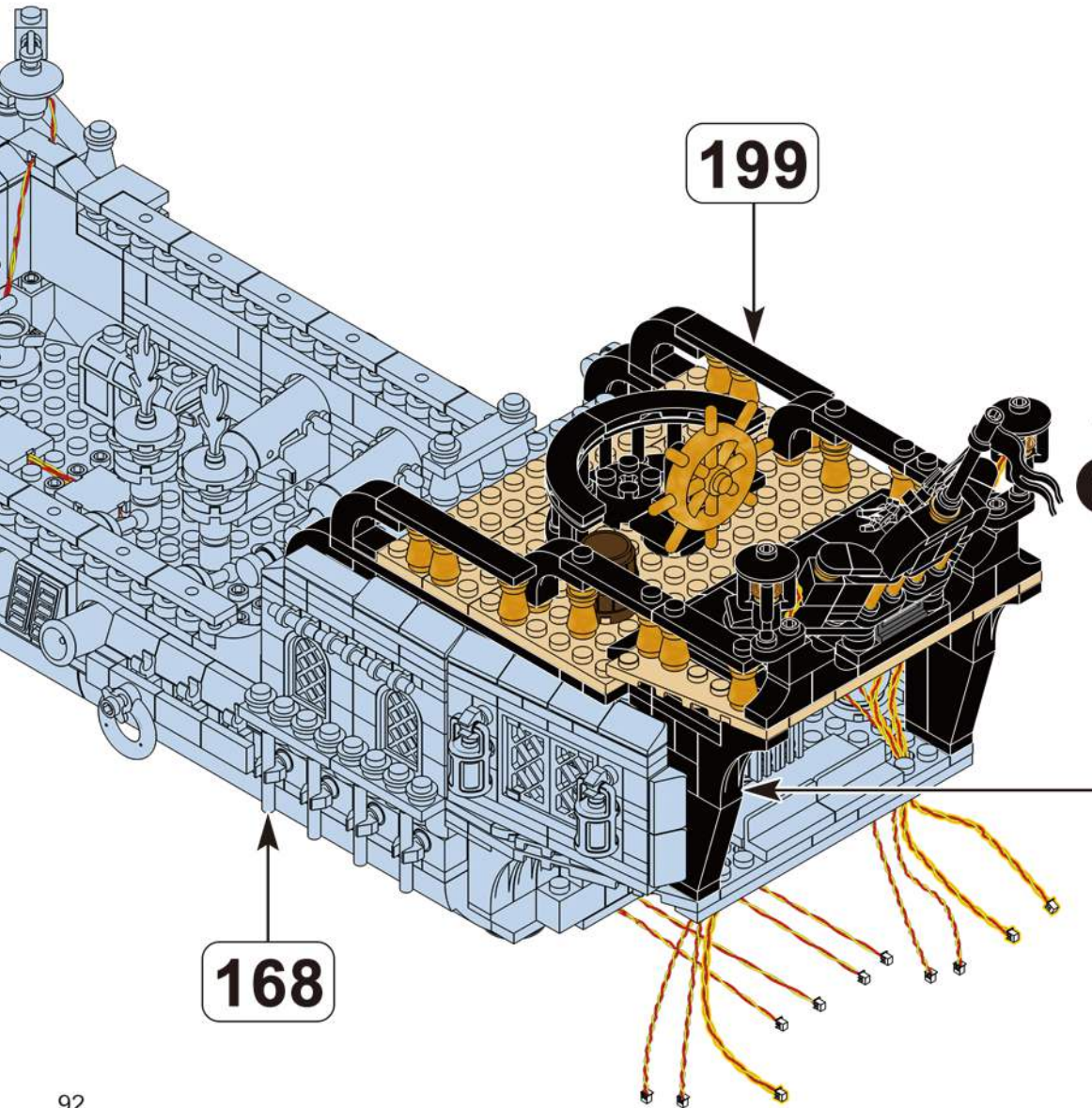

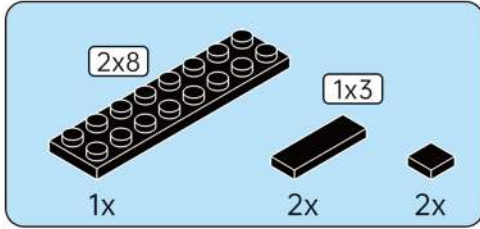

201

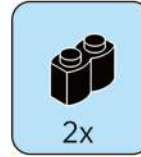
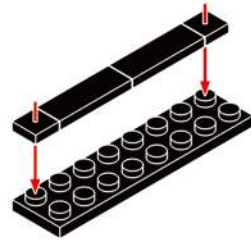

202

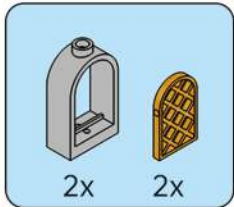
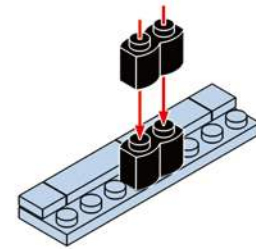

203

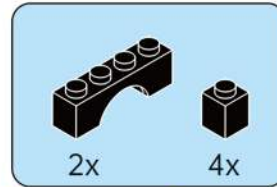
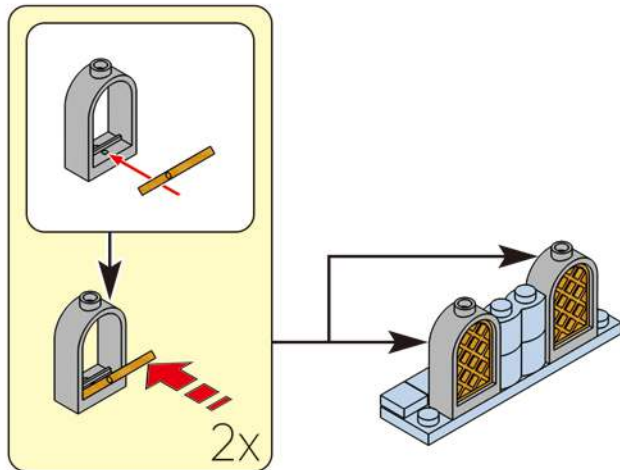

204

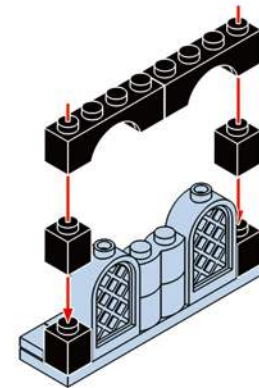

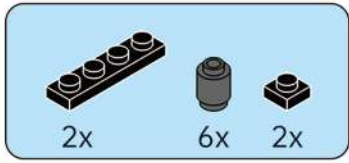

205

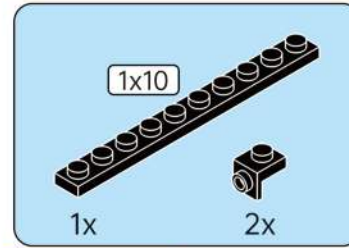
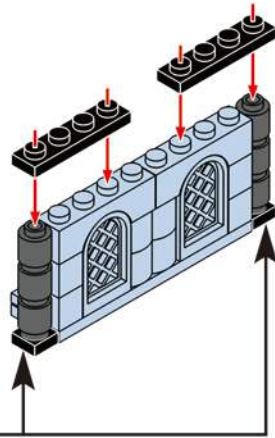
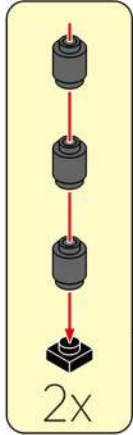

206

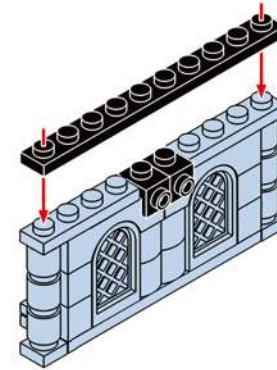

207

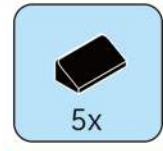
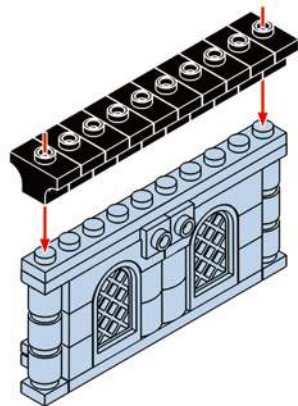

208

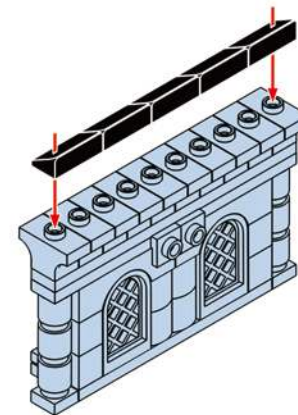

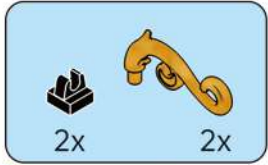

**209**

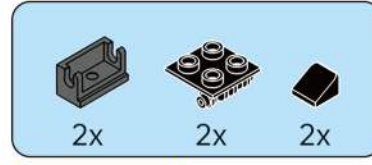
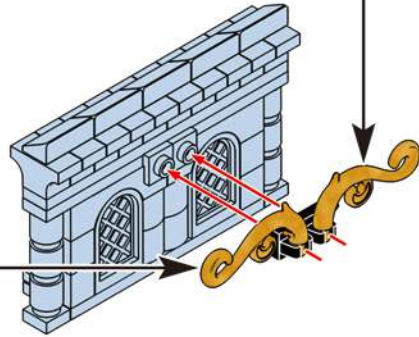
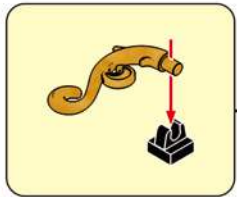
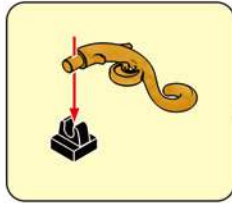

**210**

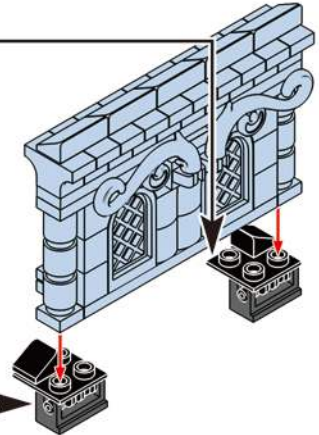
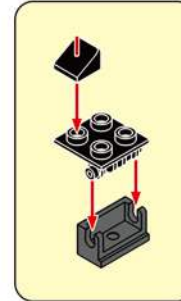
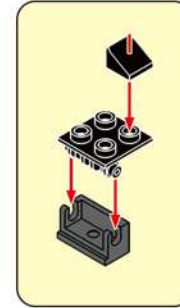

**211**

**200**

**210**

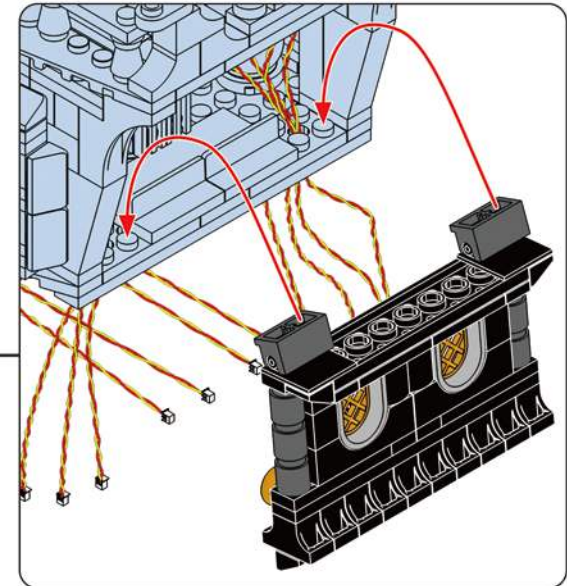
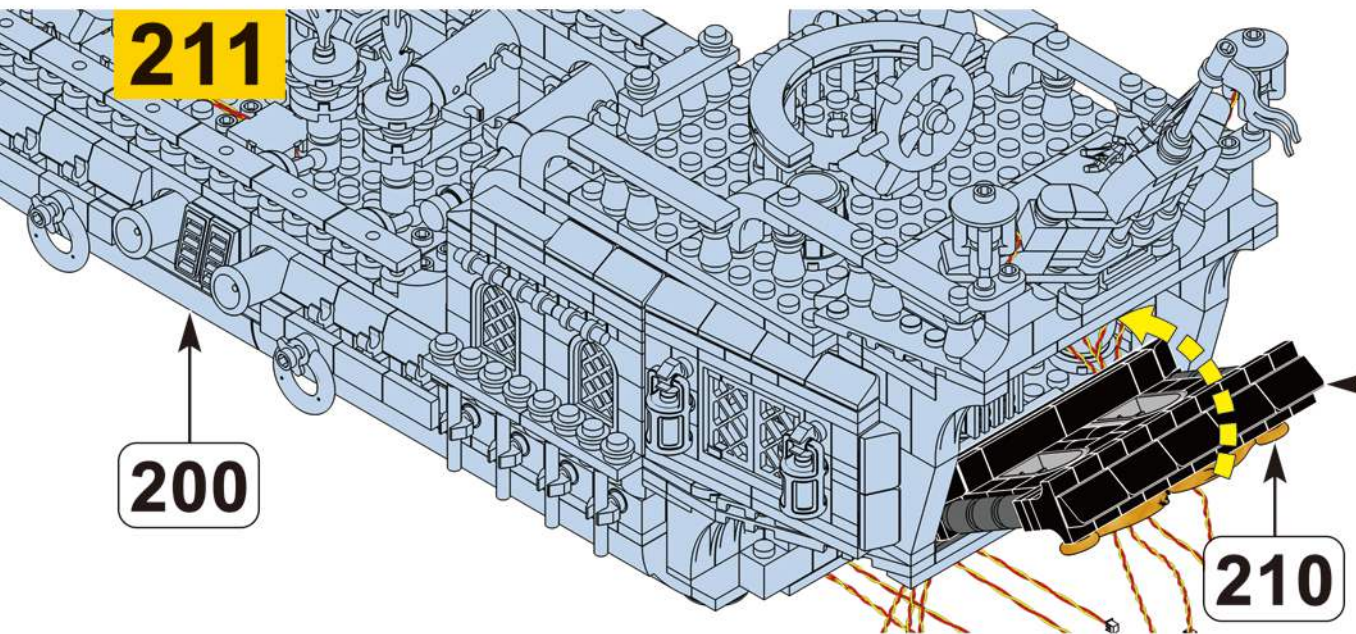

JOY MAKES BRILLIANCE

50cm/19.69in

1x

1x

212

Connectors can be inserted into ports of the expansion boards in only one way. Make sure the plug faces the right way before connecting.

Tips: If the plug doesn't fit easily into a port connector, please don't force it. Otherwise, it will damage the plug and connector, and even cause a short circuit. If you suspect a short circuit, DISCONNECT POWER IMMEDIATELY to avoid dangers.

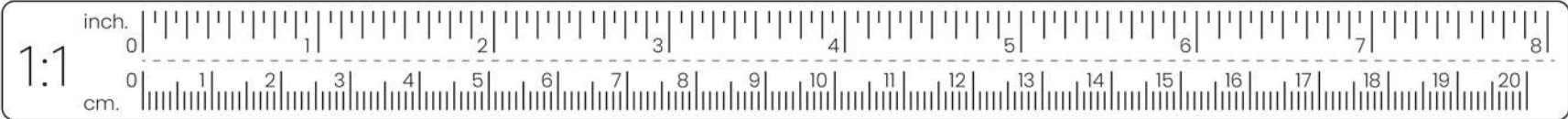
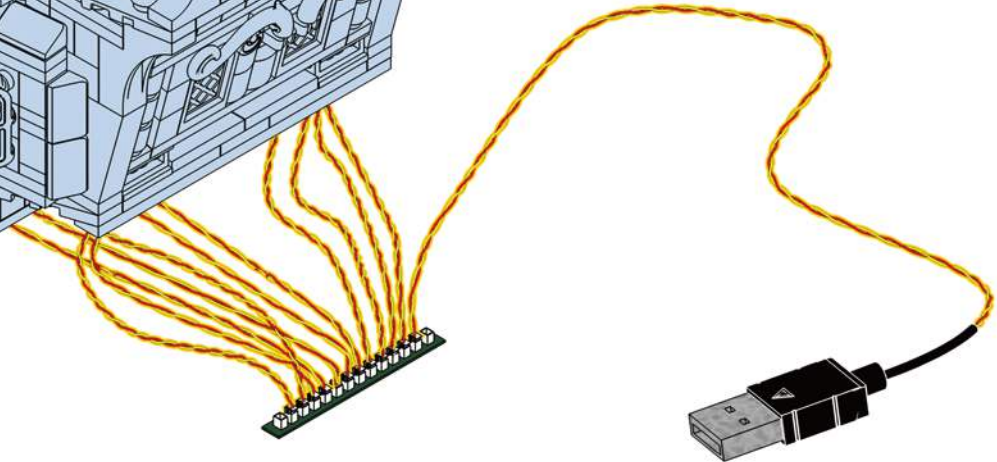

213

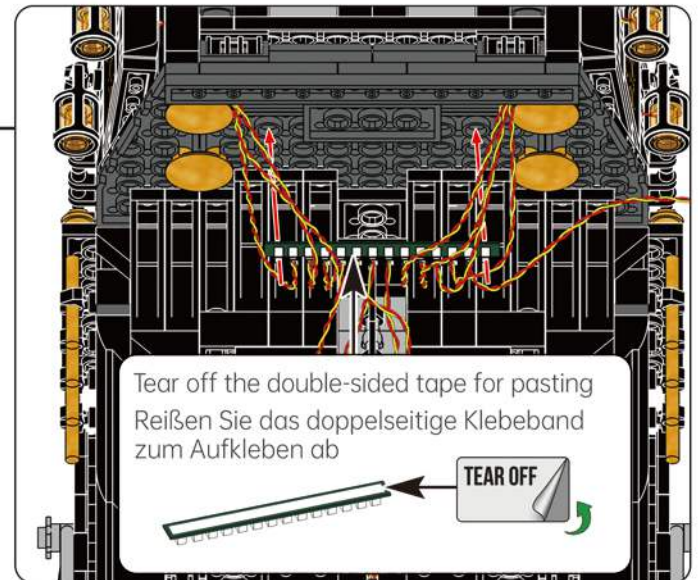
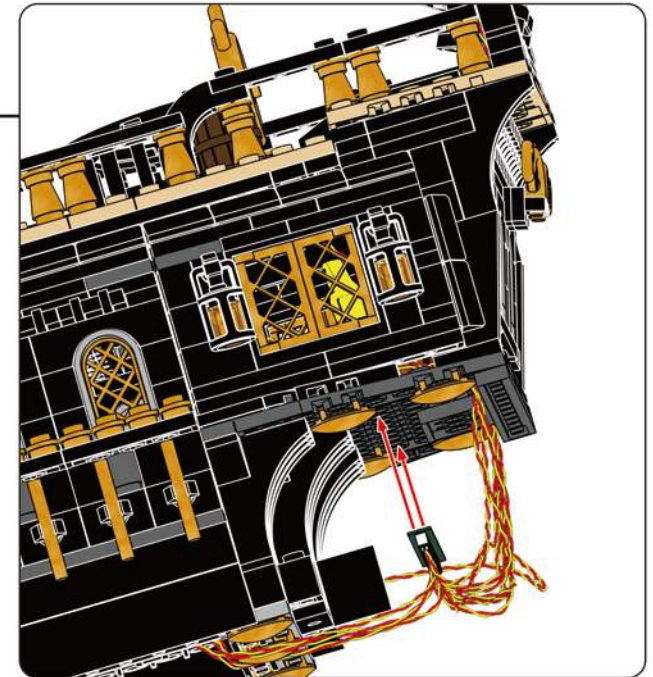
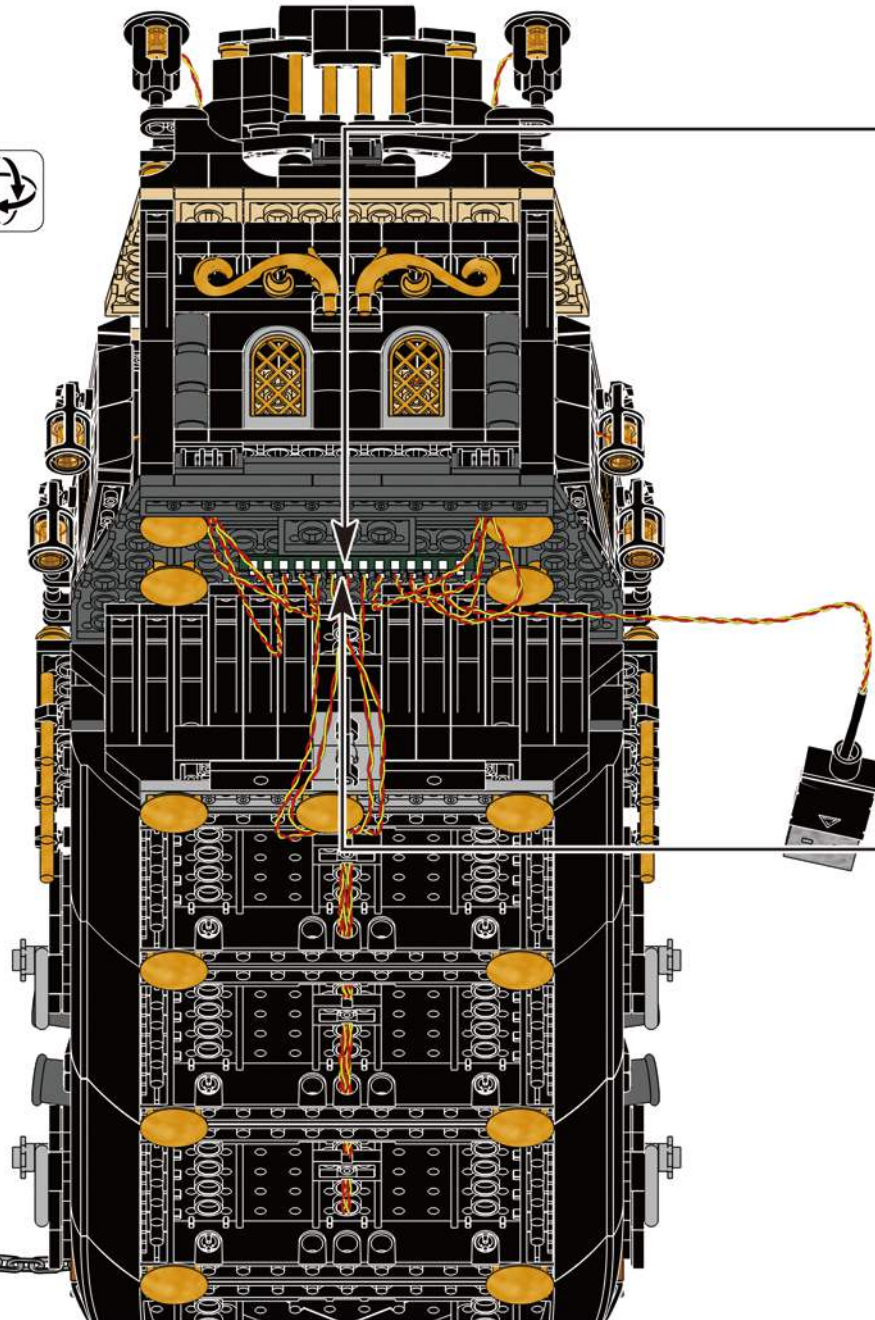

# JOY MAKES BRILLIANCE.

## Embrace Relaxation Embrace Joy

Every adultescent needs a "JOY BOX".  
Please , open your JOY BOX ! Heading for joy.

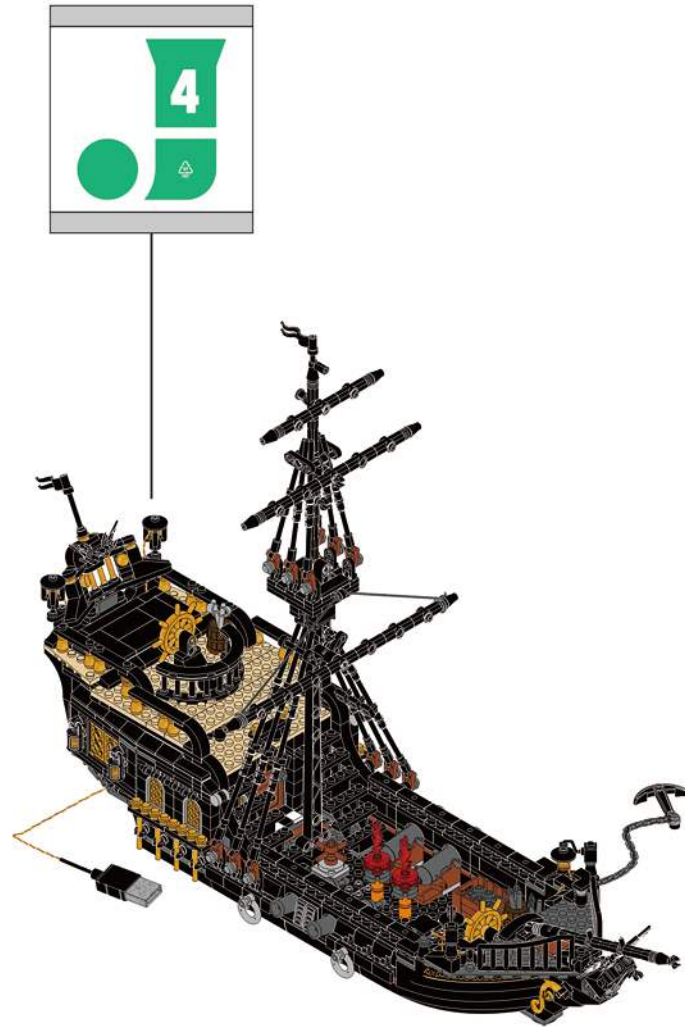

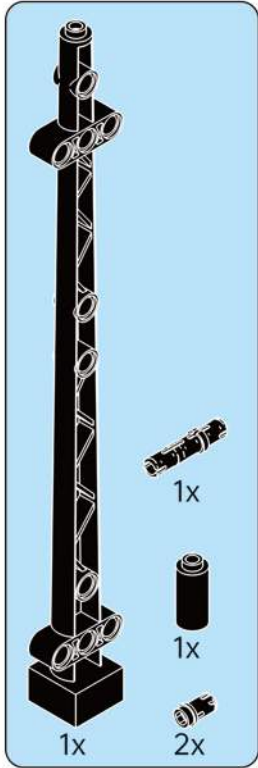

**214**

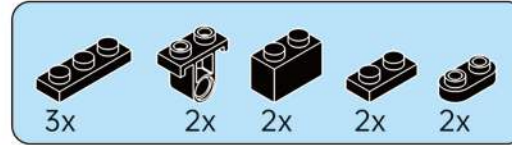

**215**

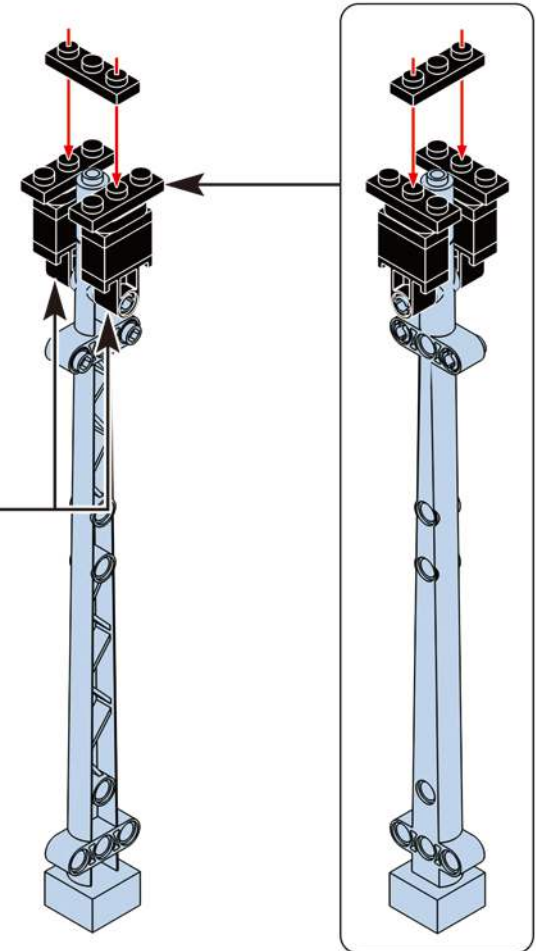
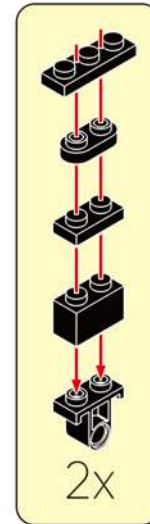

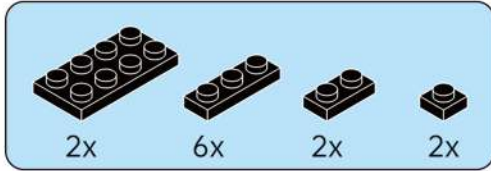

# 216

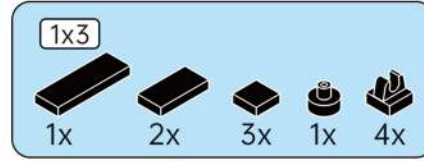
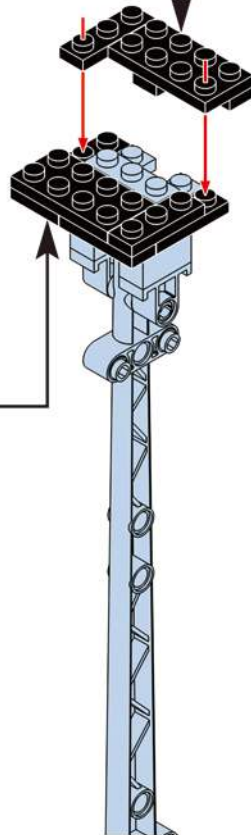
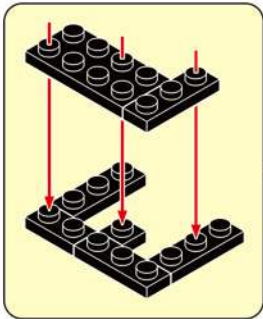
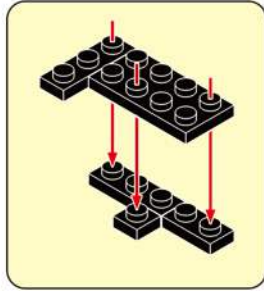

# 217

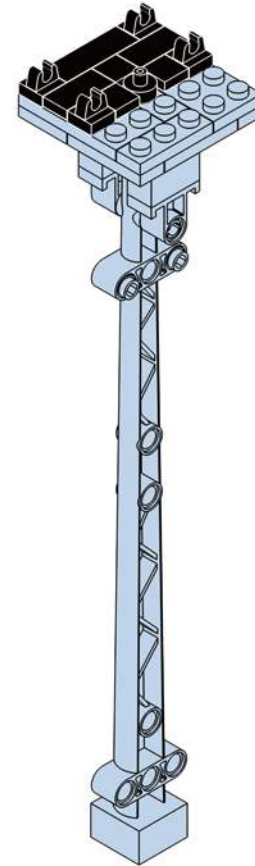



# 218

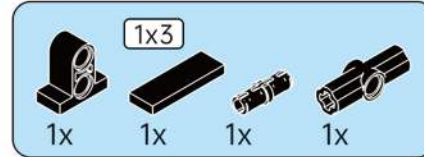
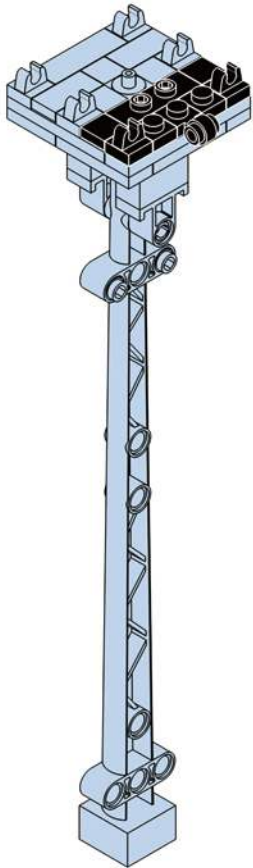

# 219

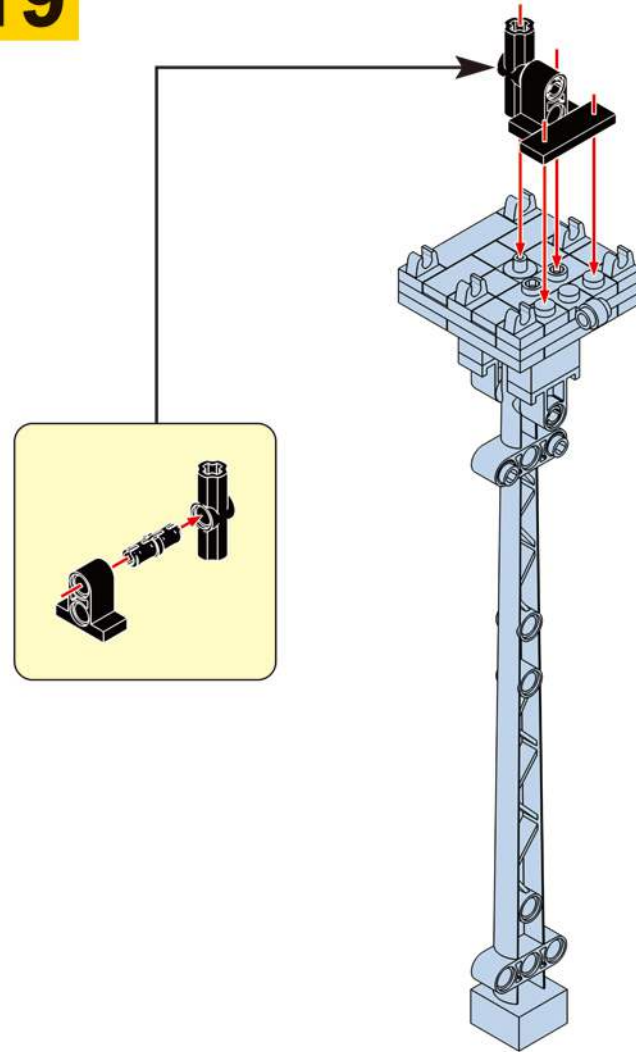

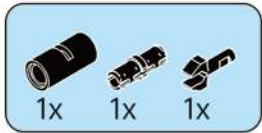

**220**

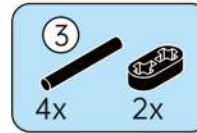
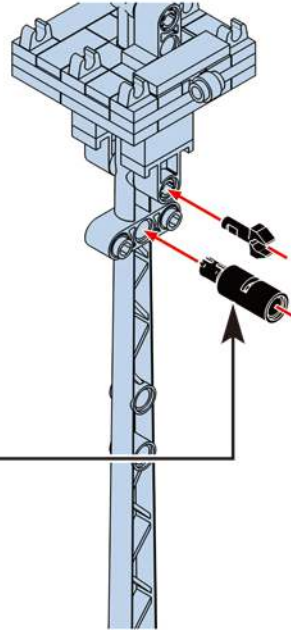
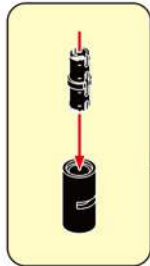

**221**

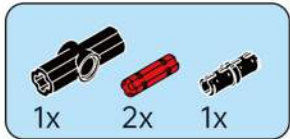
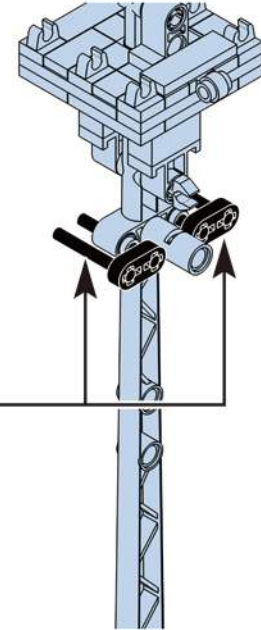
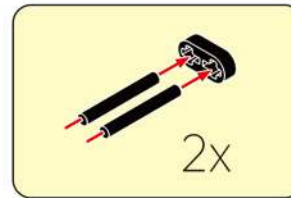

**222**

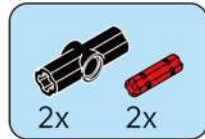

**223**

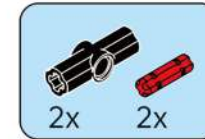
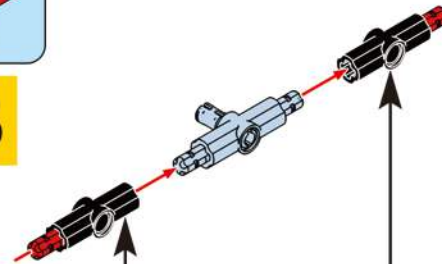
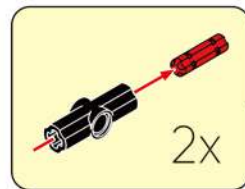

**224**

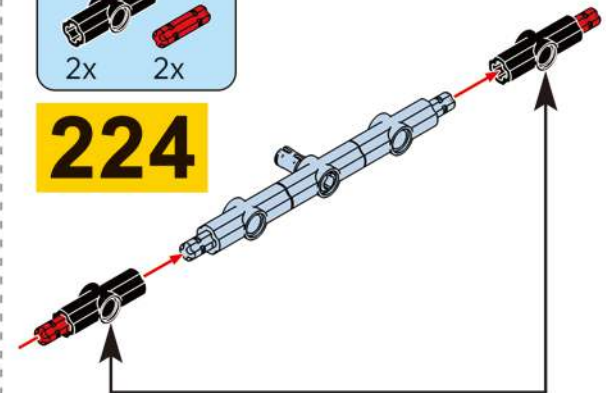
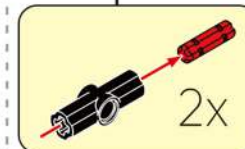

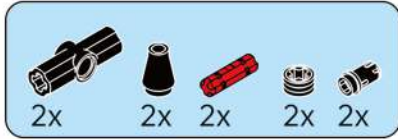

# 225

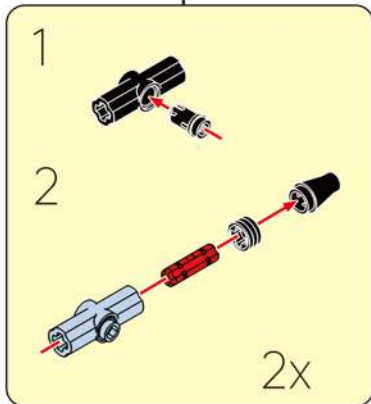
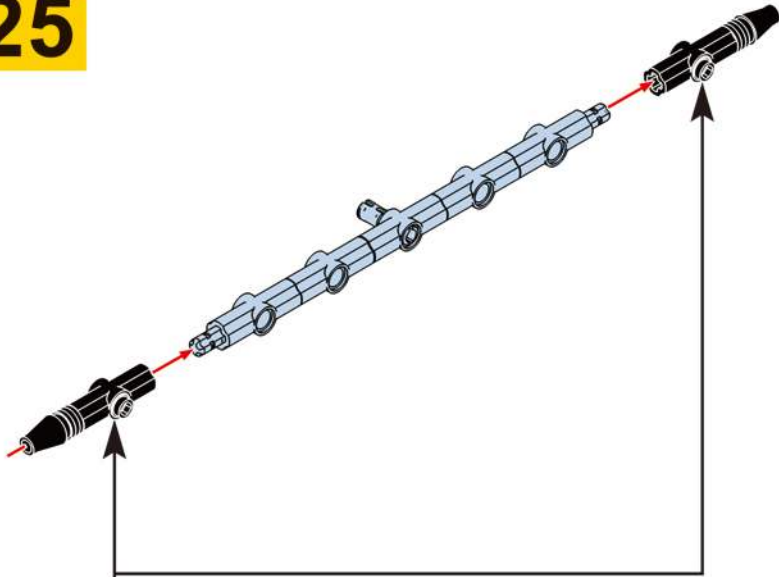

# 226

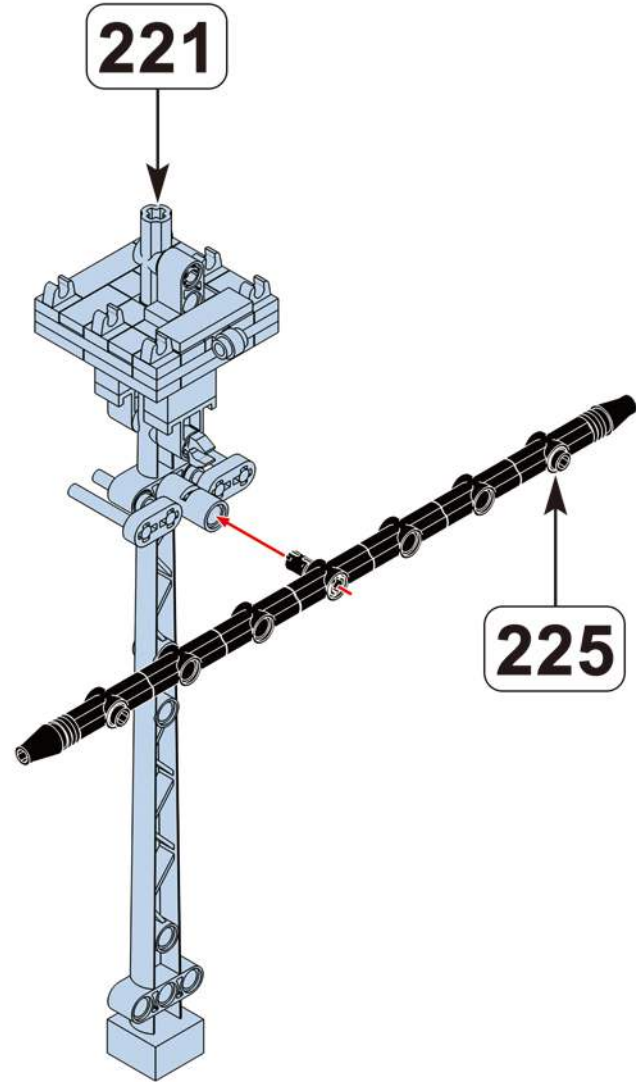

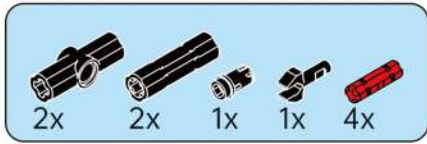

# 227

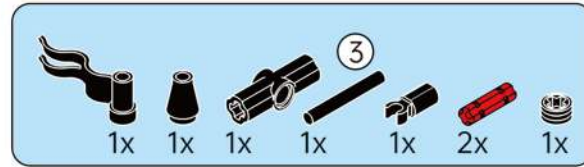
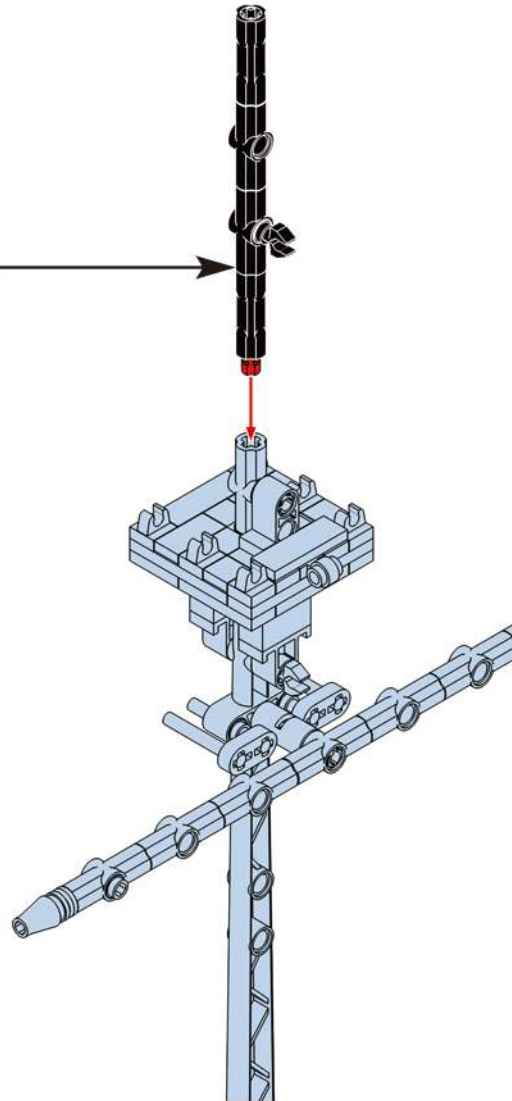
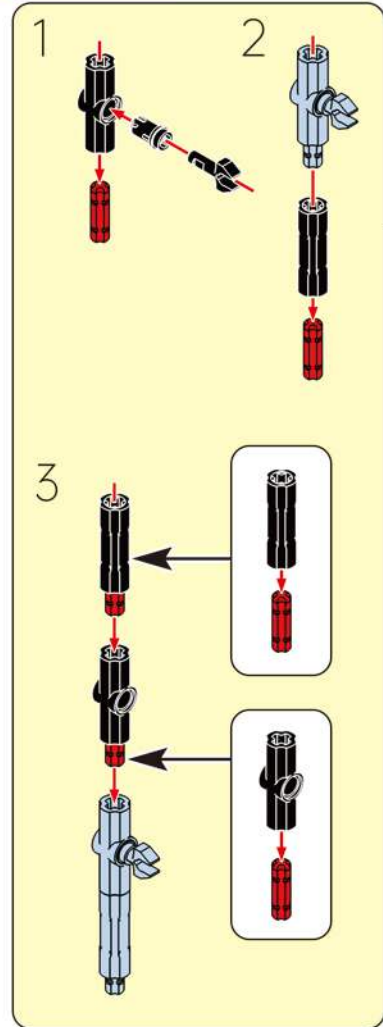

# 228

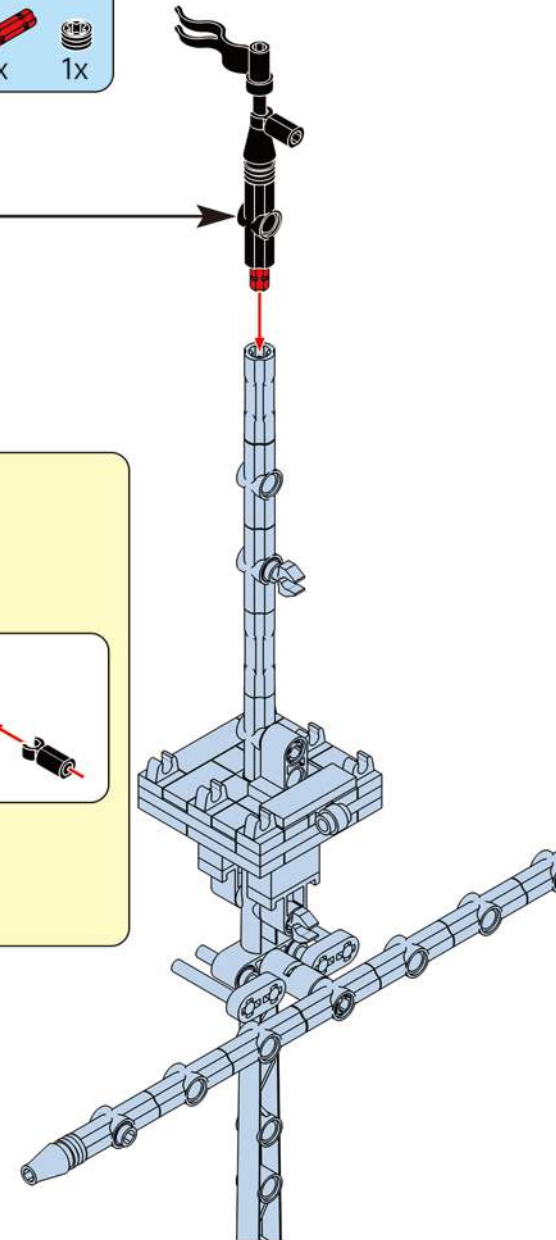
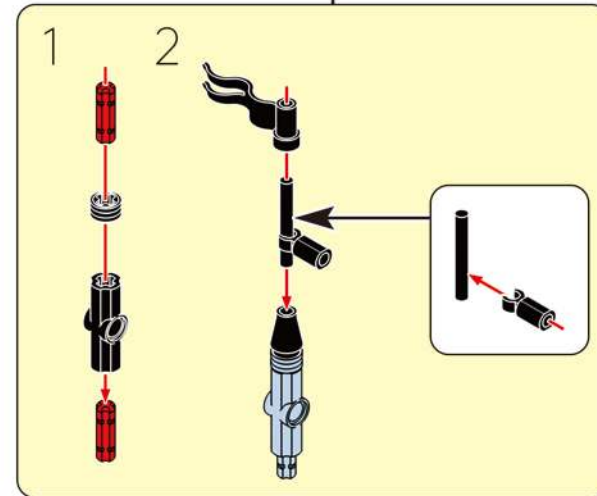



**229**

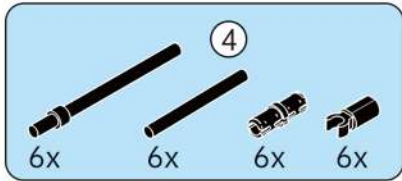
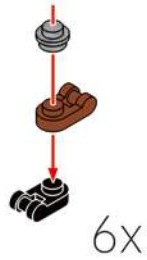

**230**

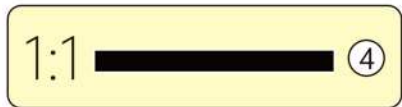
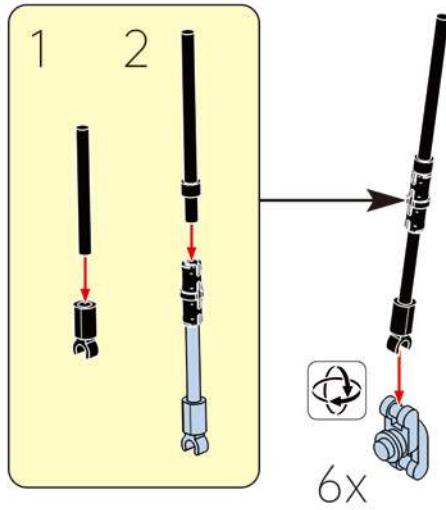

**231**

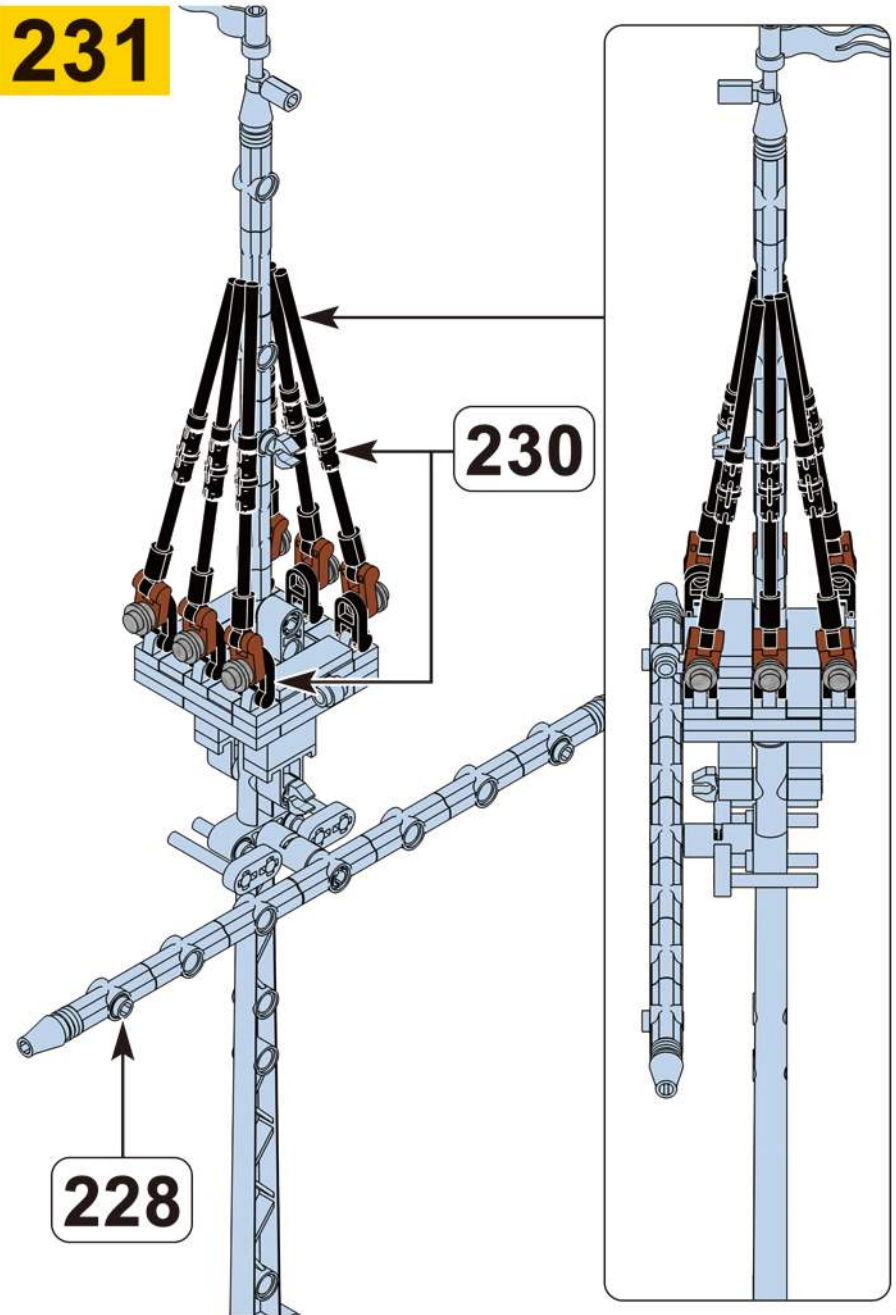

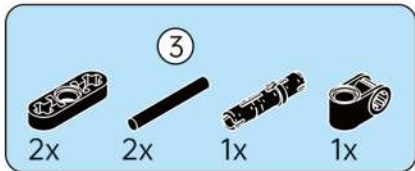

232

1:1 ③

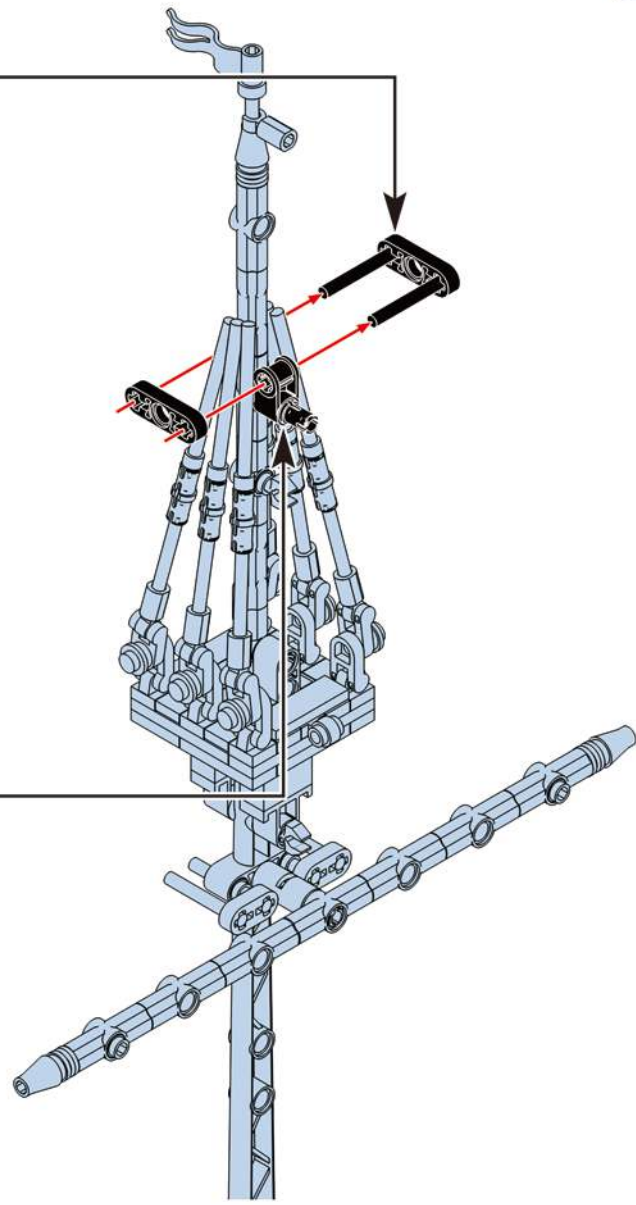
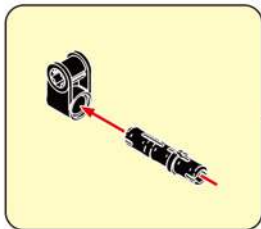
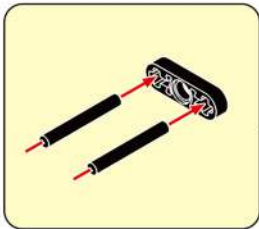

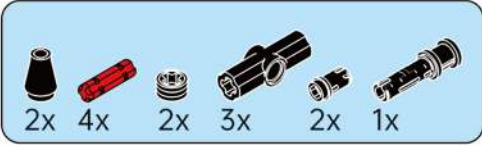

# 233

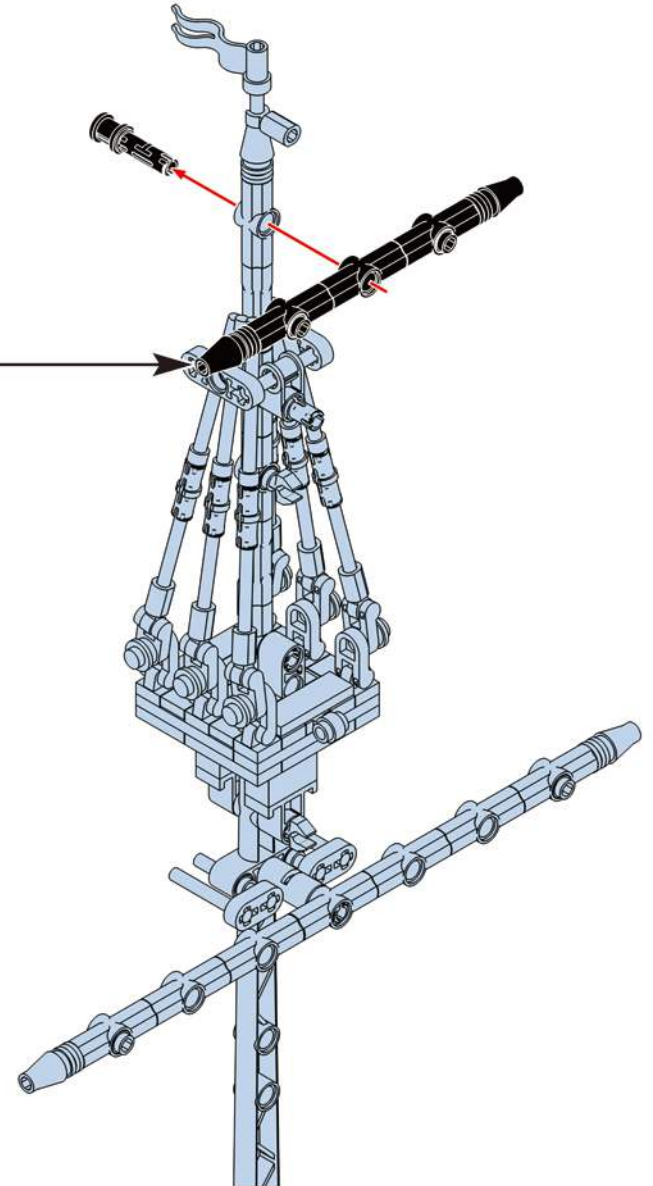
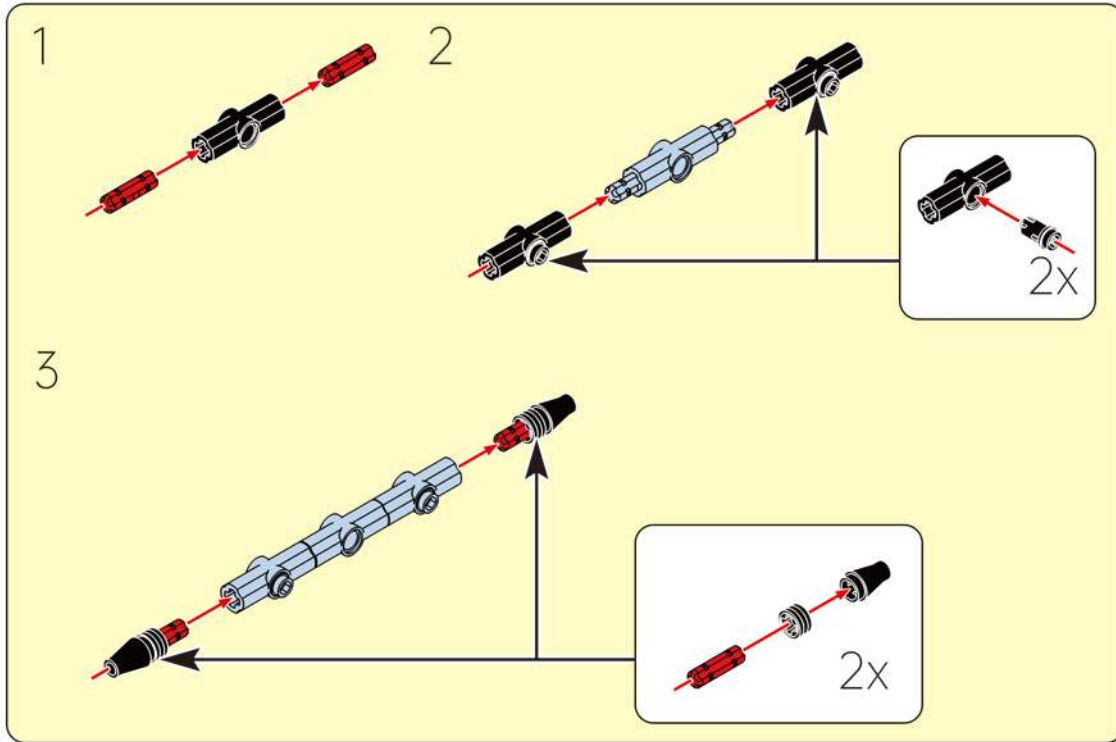



234

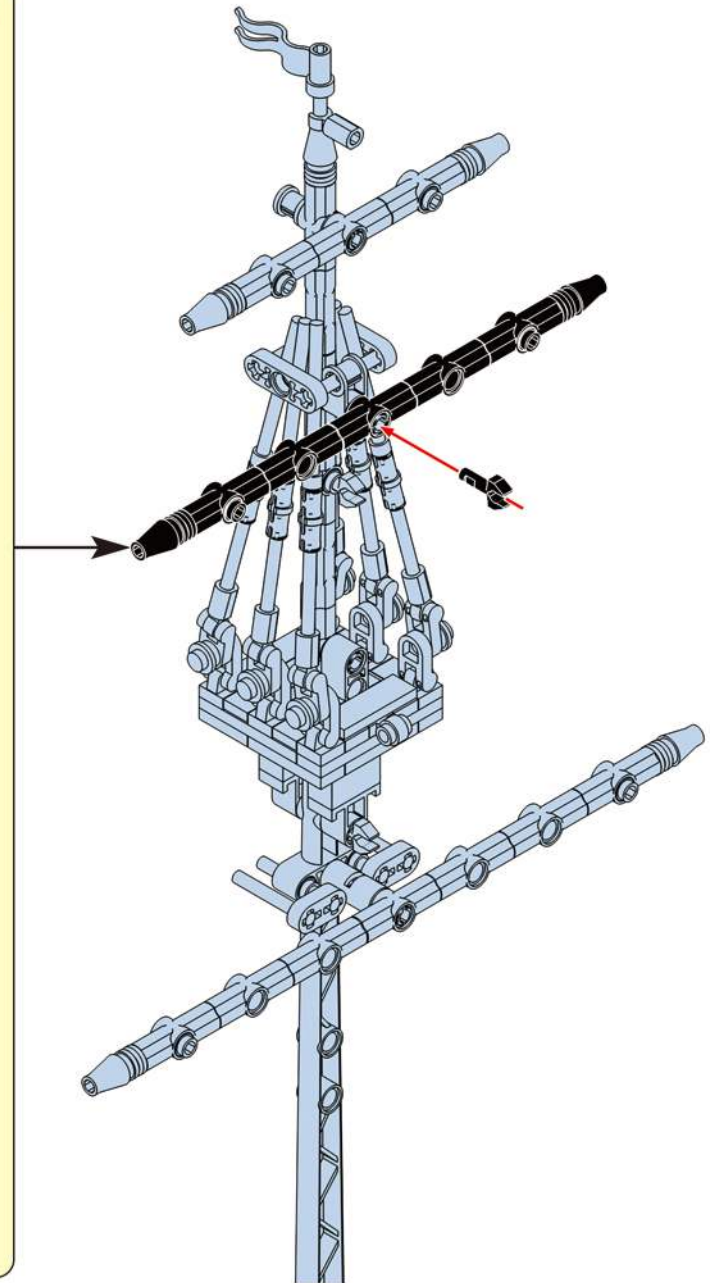
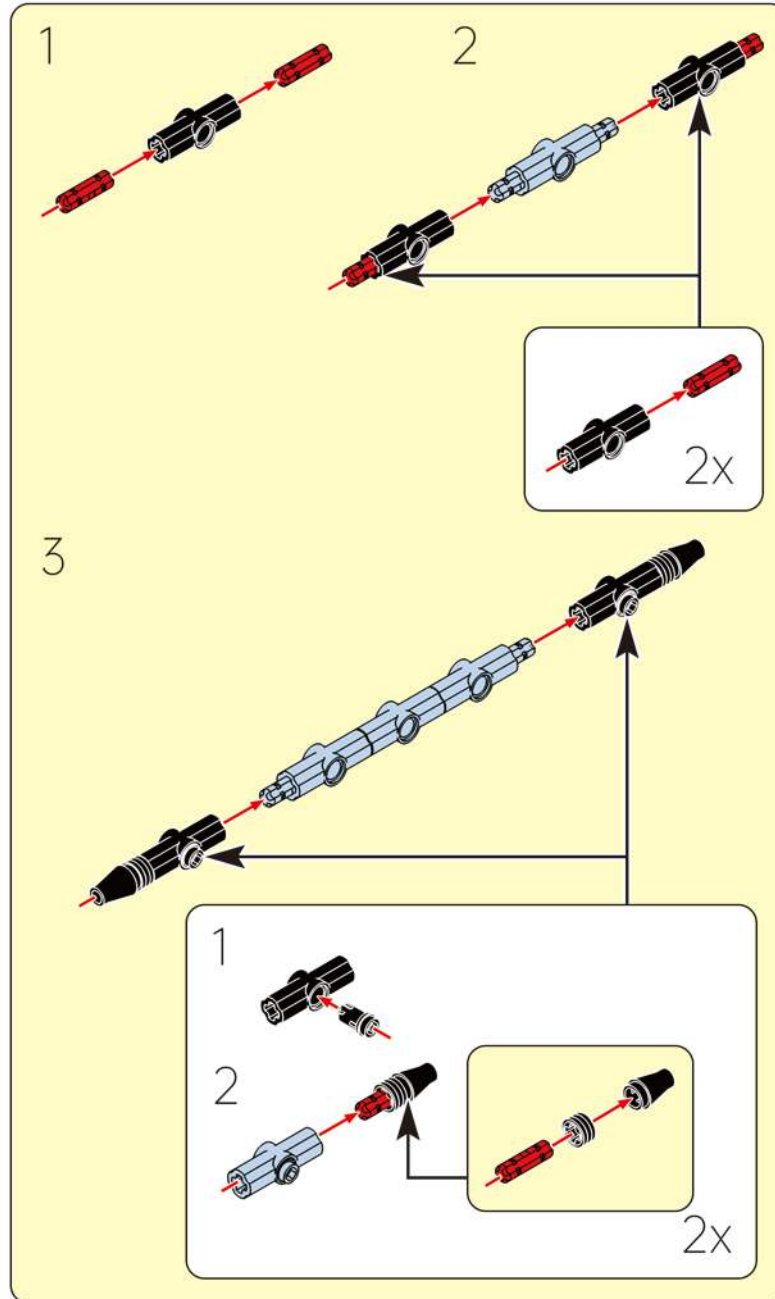



**235**

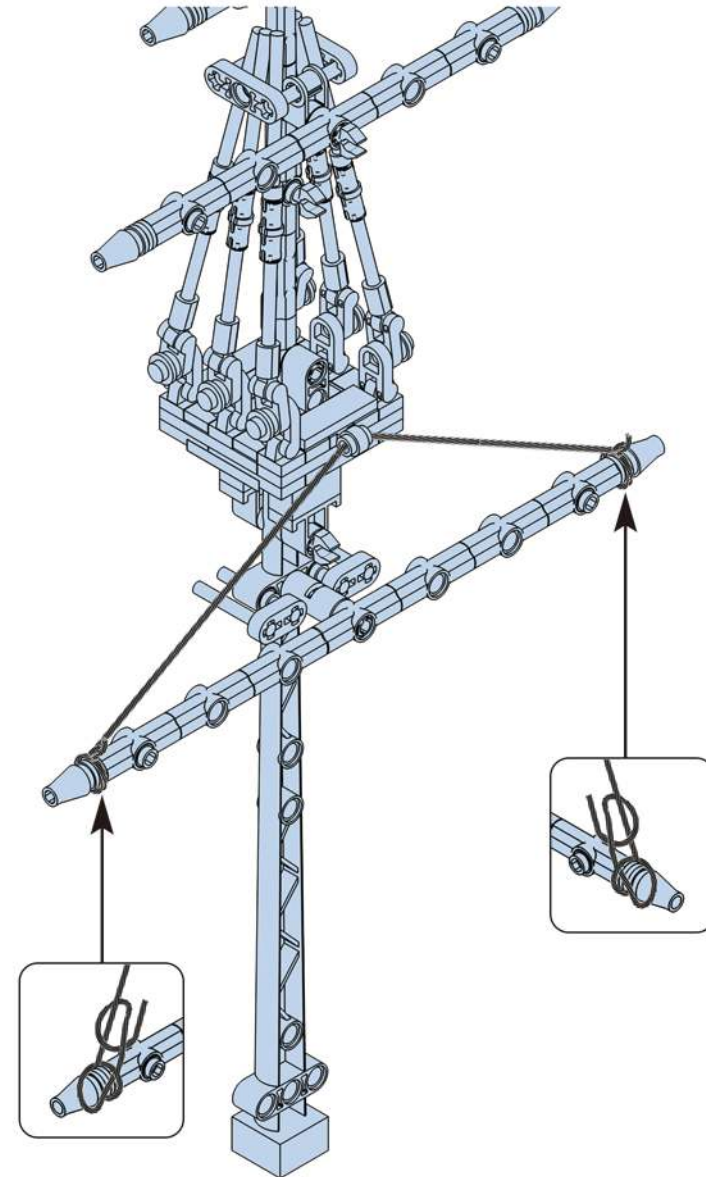

After installing the rope tie, the excess of the rope can be cut with a shear.

Nach der Installation des Seilkaktes kann der Überschuss des Seils mit einer Schere geschnitten werden.

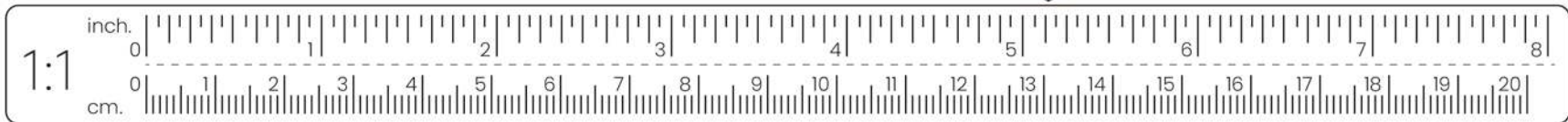

236

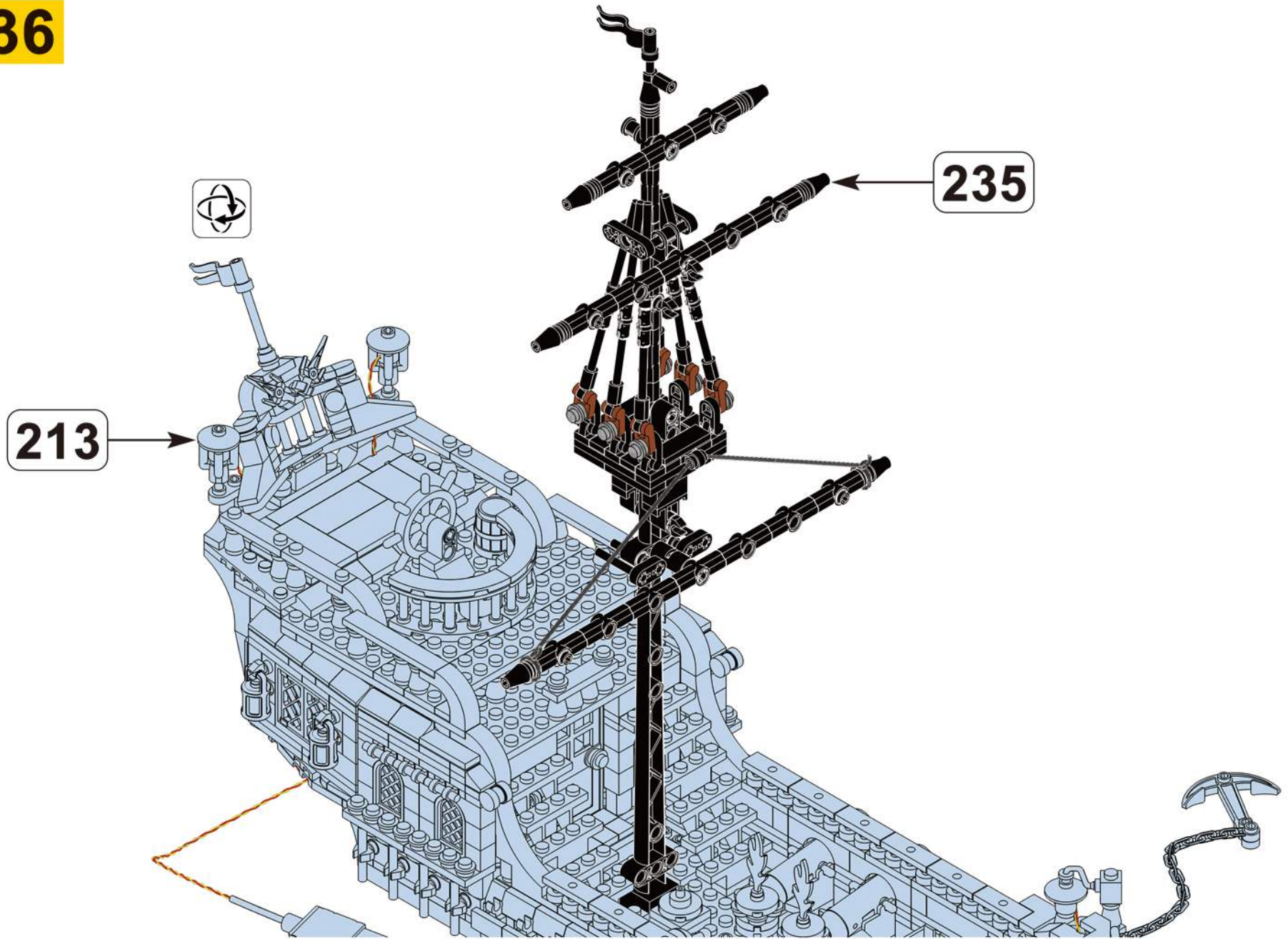



# 237

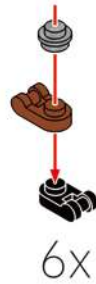

# 238

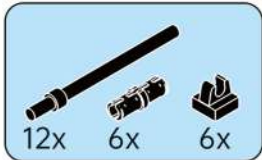
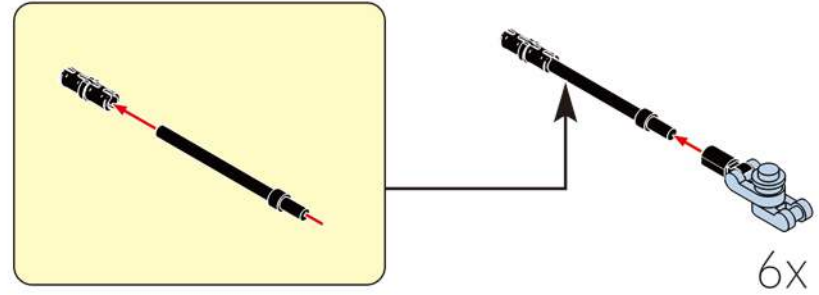

# 239

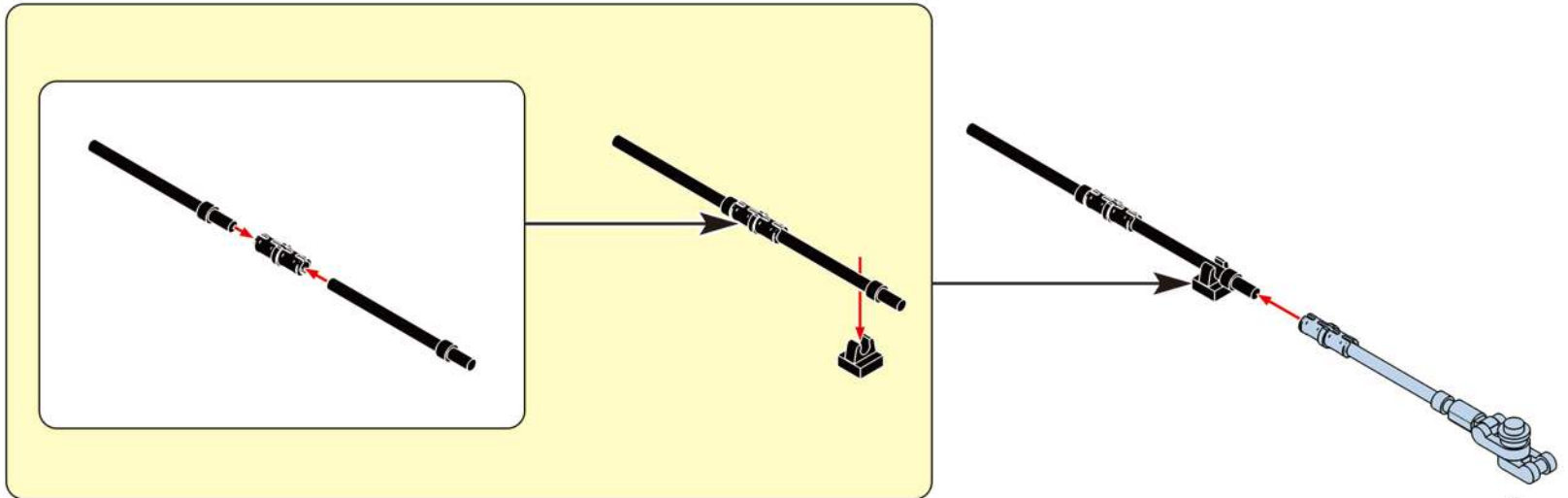

240

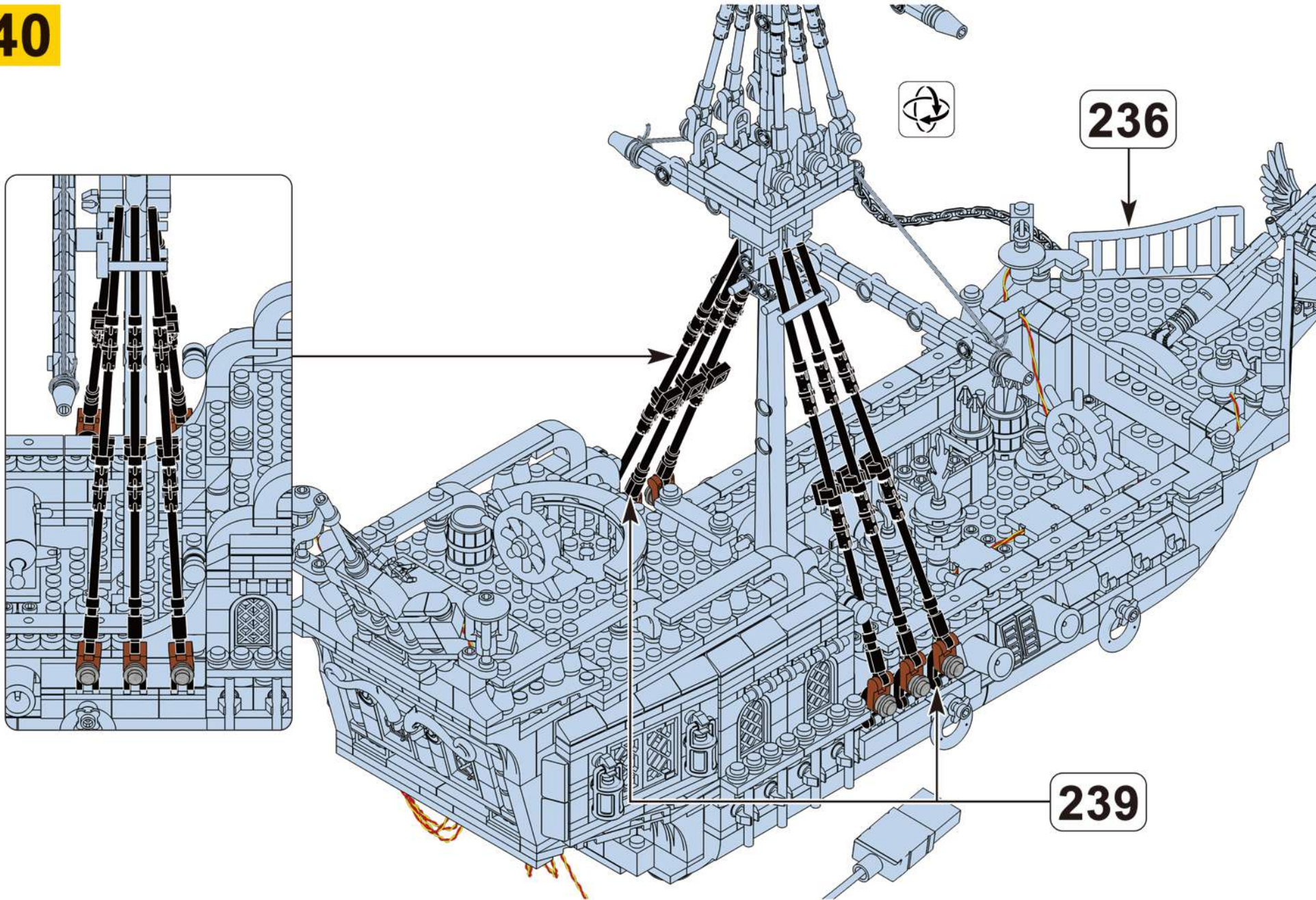

-  2x
-  2x
-  1x

241

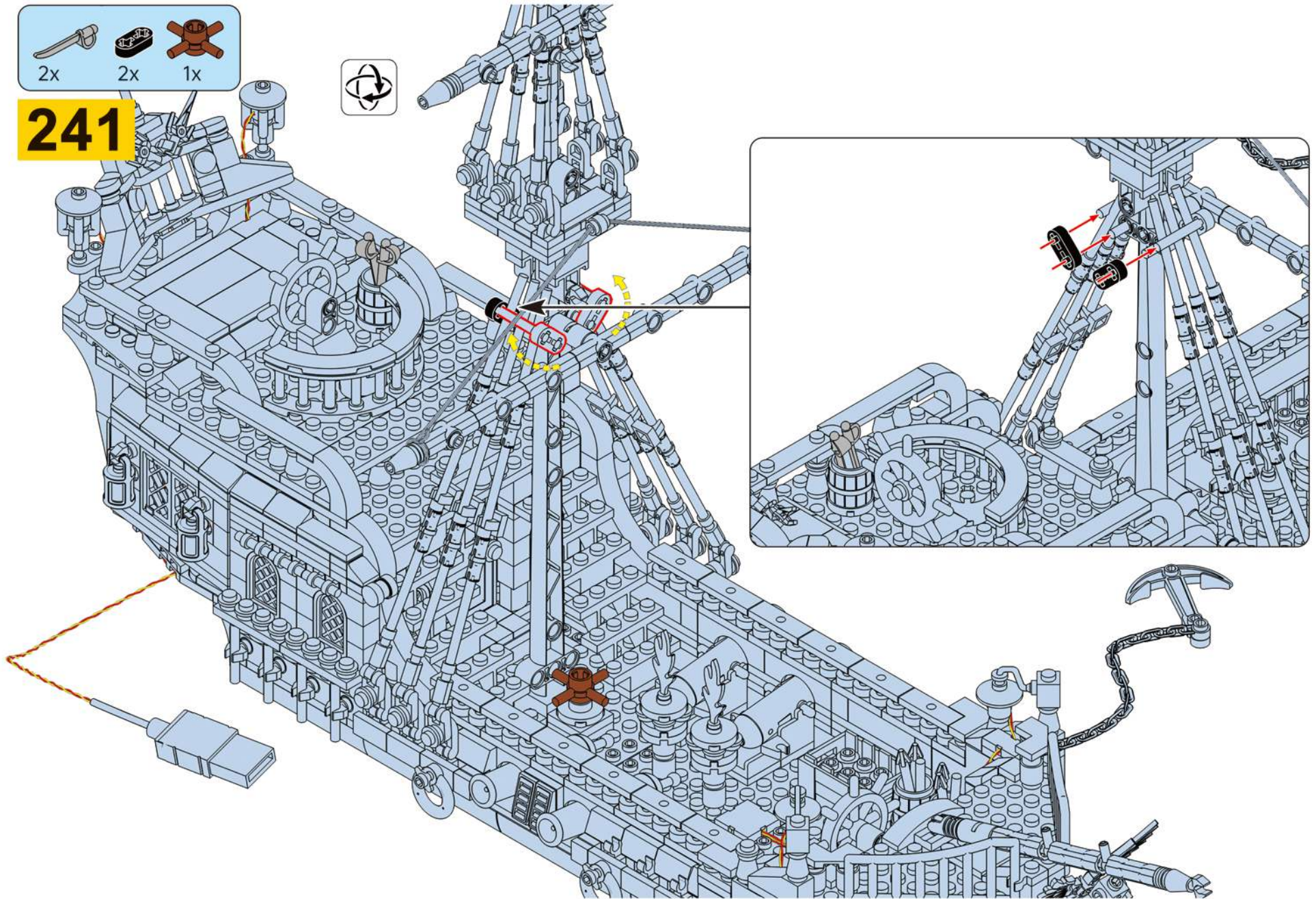

# JOY MAKES BRILLIANCE.

## Embrace Relaxation Embrace Joy

Every adultescent needs a "JOY BOX".  
Please, open your JOY BOX ! Heading for joy.

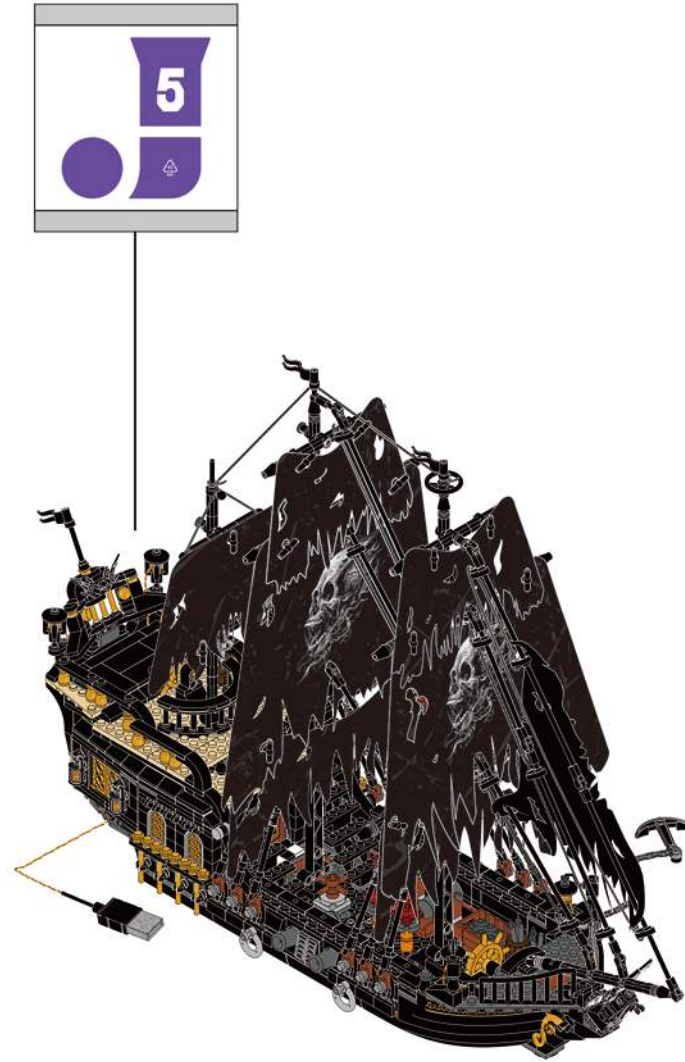

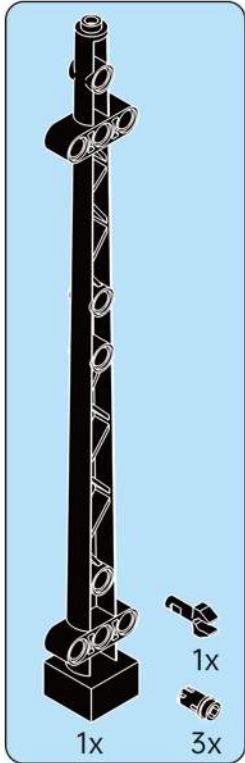

242

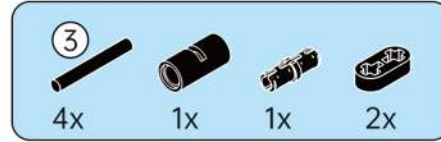
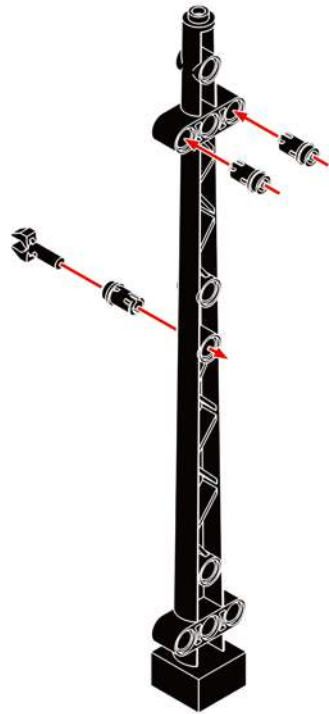

243

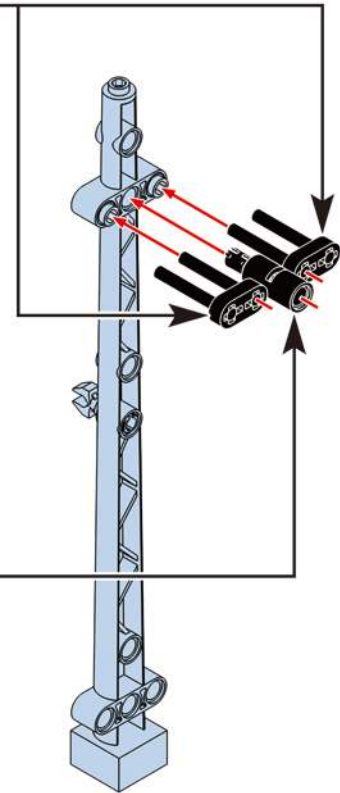
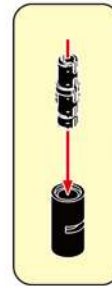
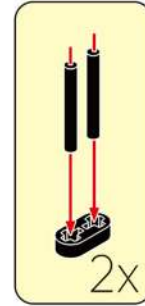

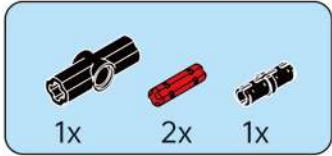

**244**

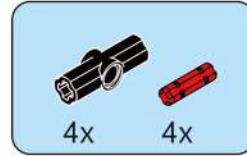
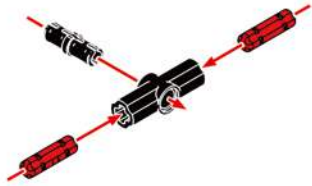

**245**

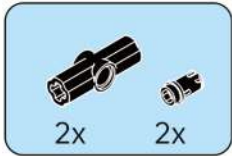
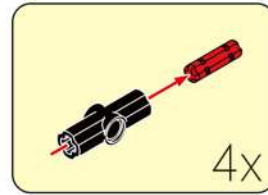
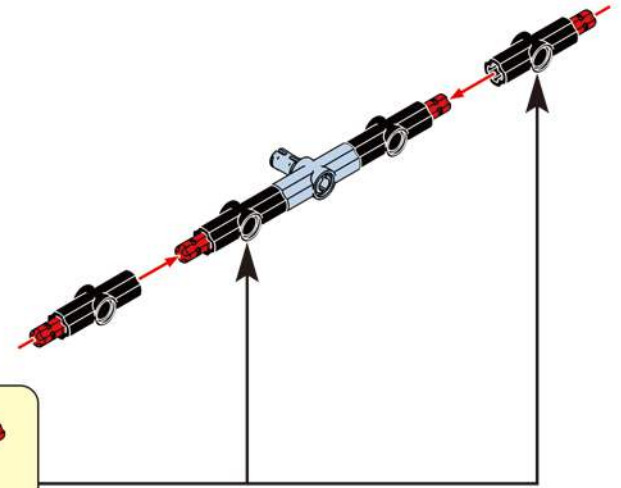

**246**

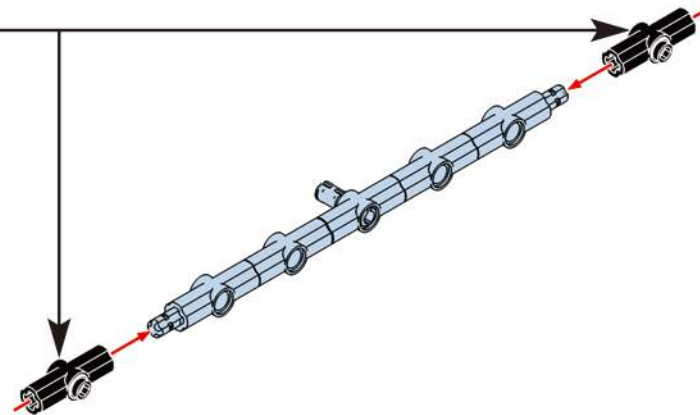
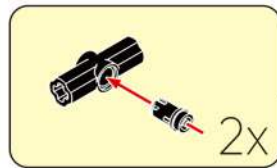



# 247

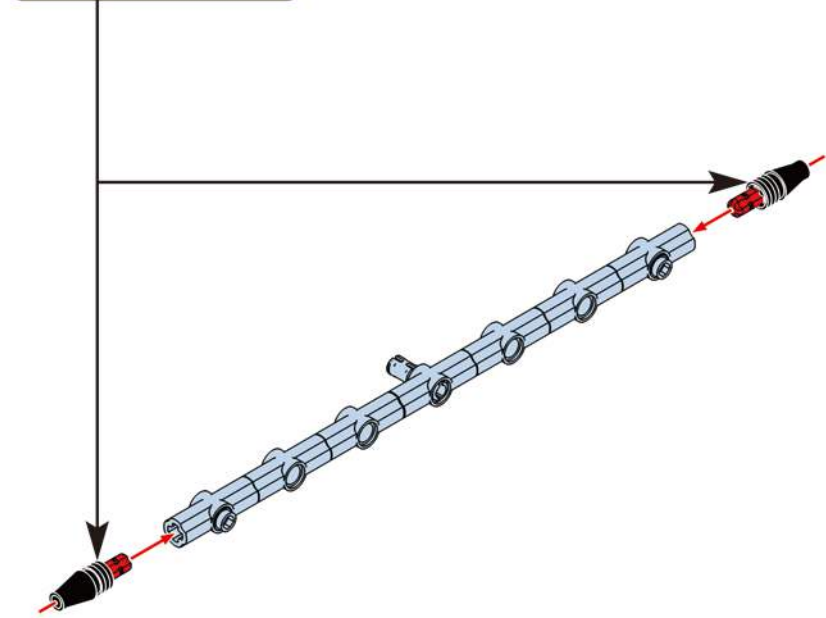
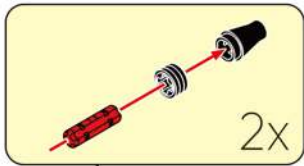

# 248

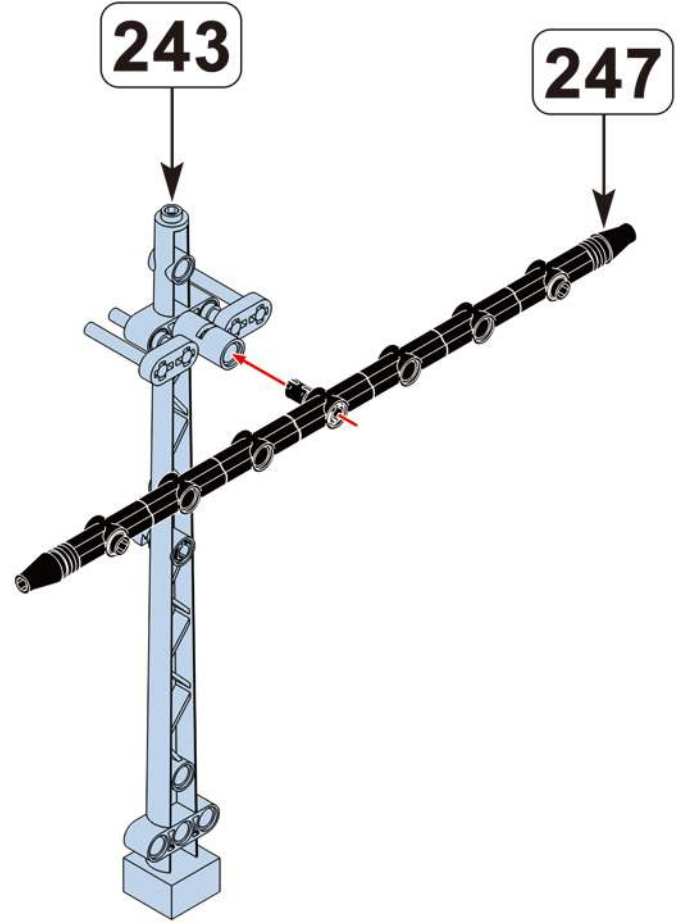

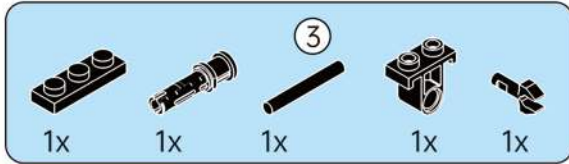

# 249

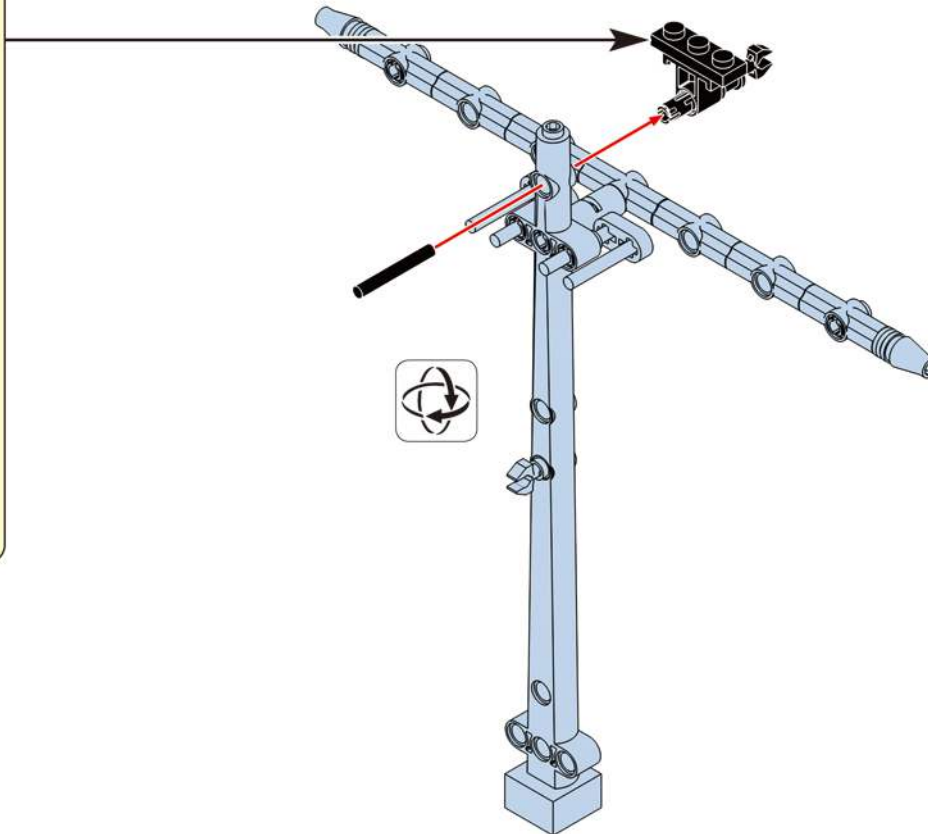
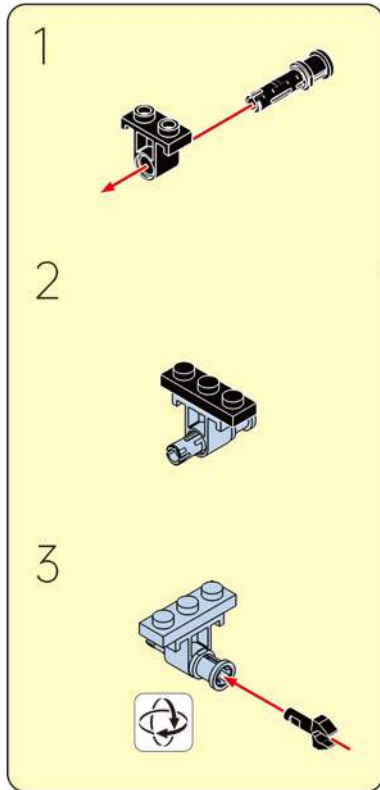

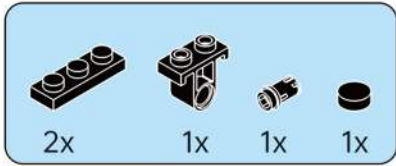

# 250

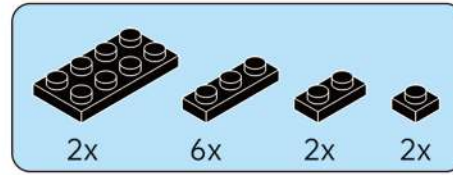
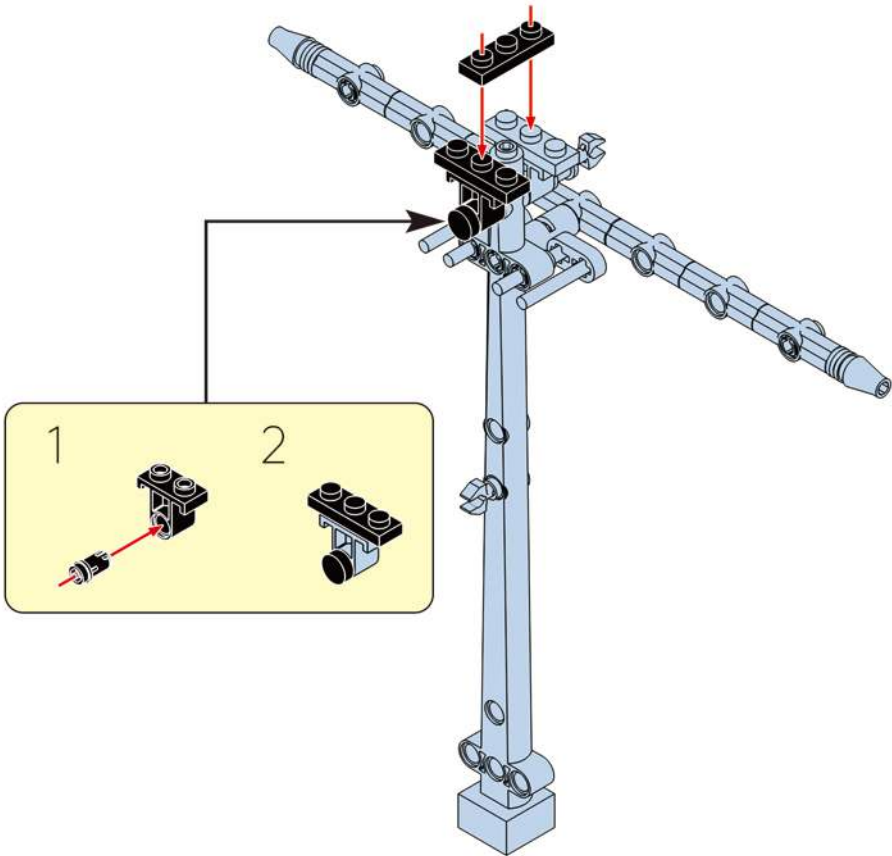

# 251

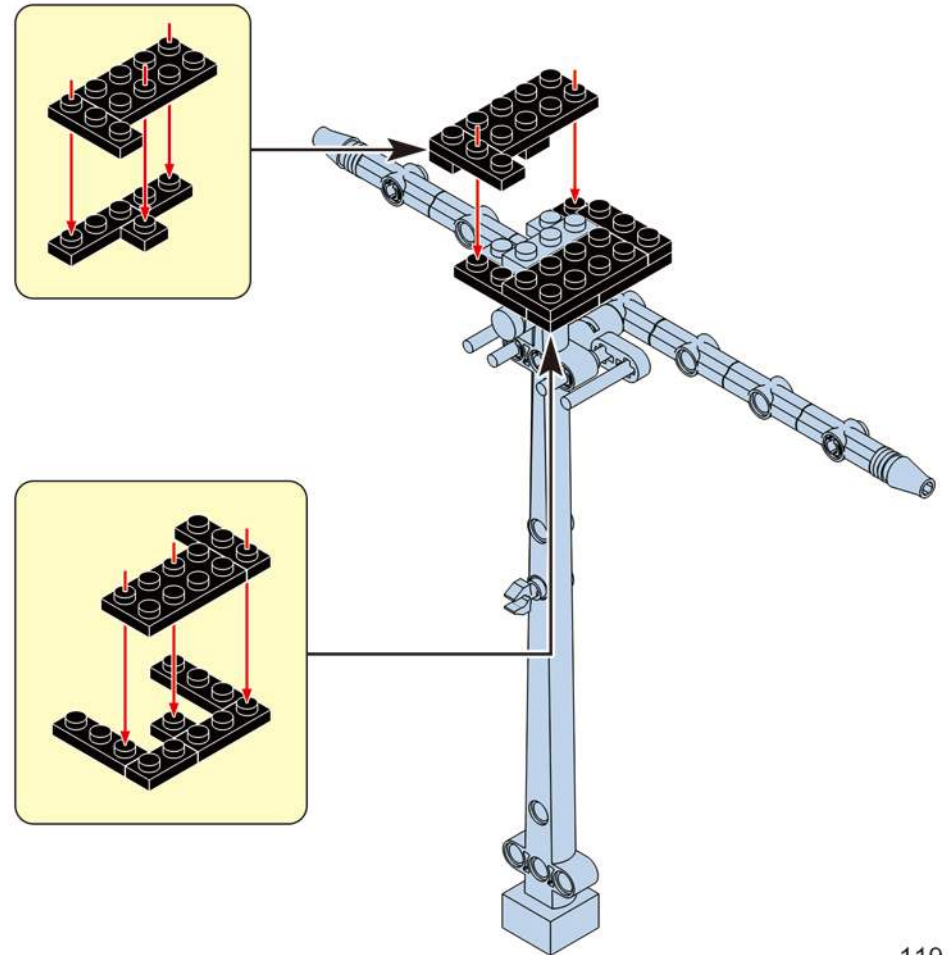

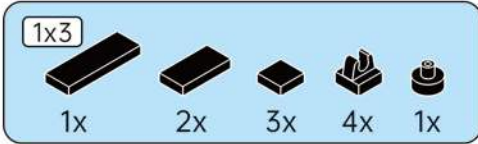

# 252

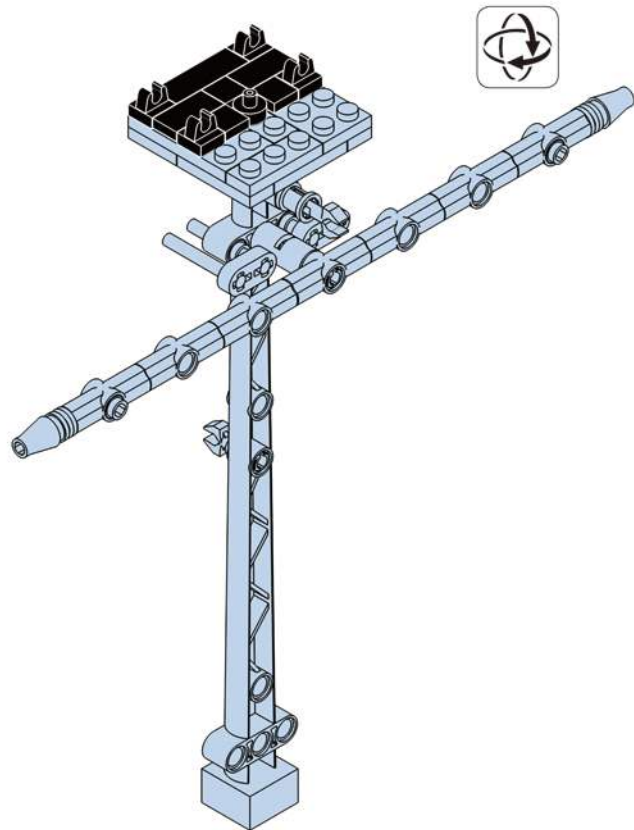

# 253

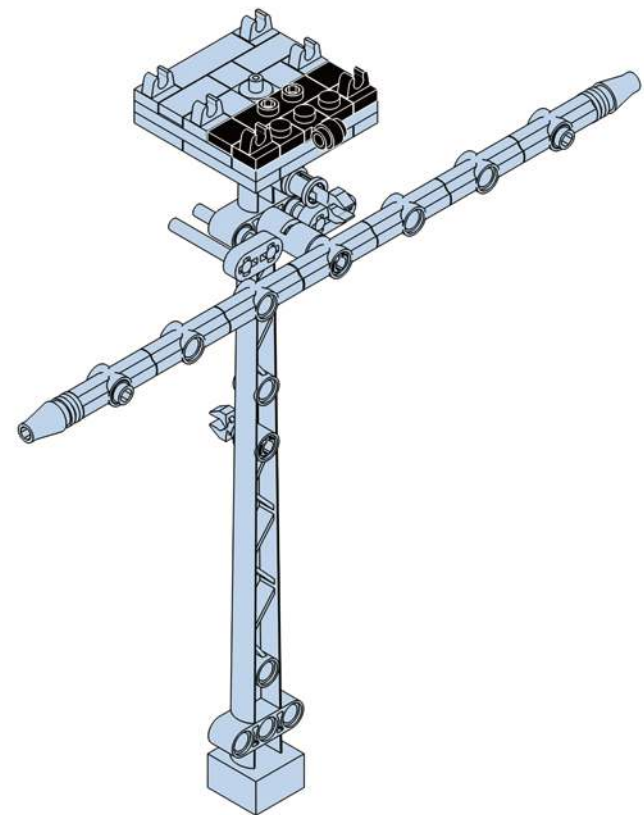

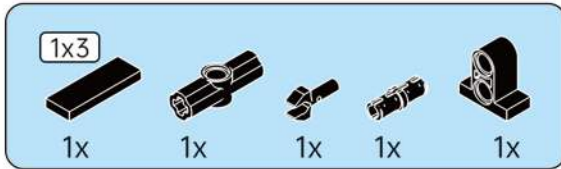

# 254

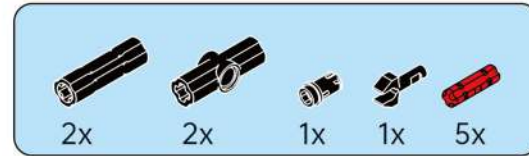
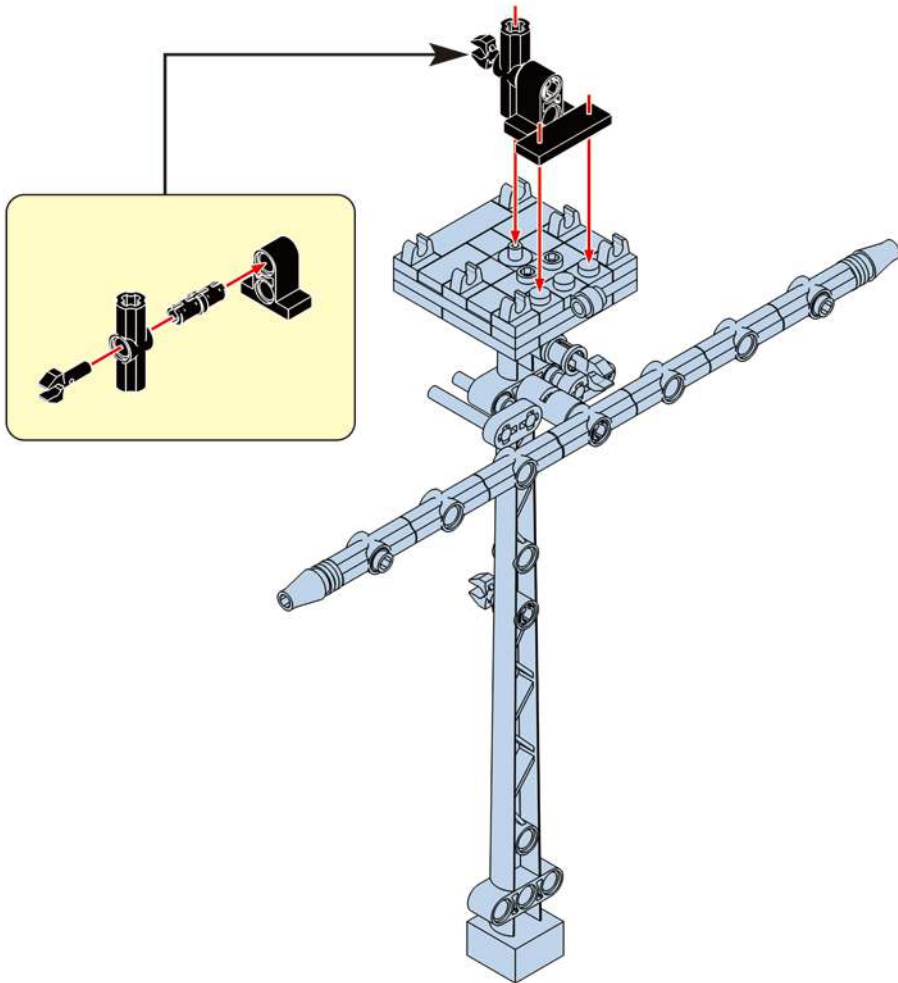

# 255

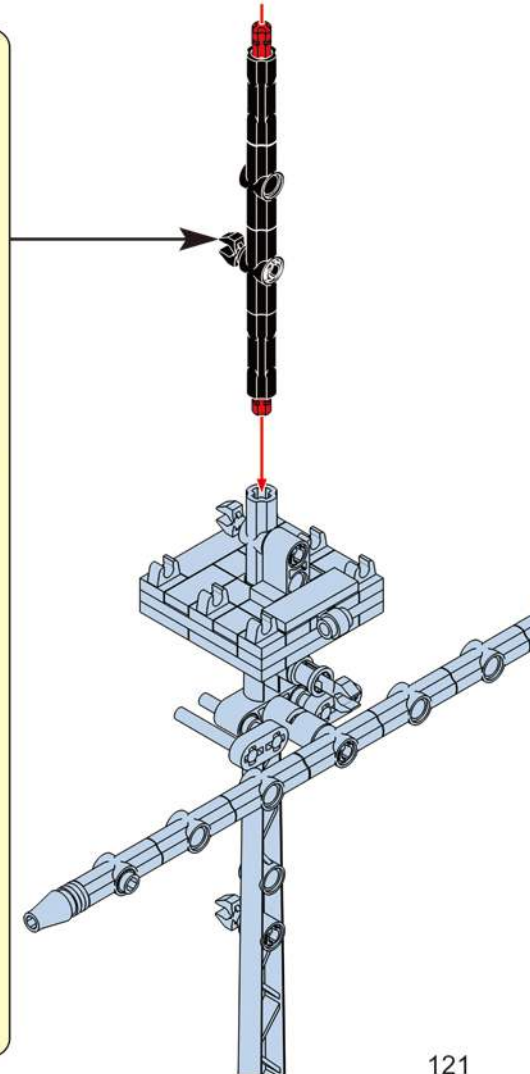
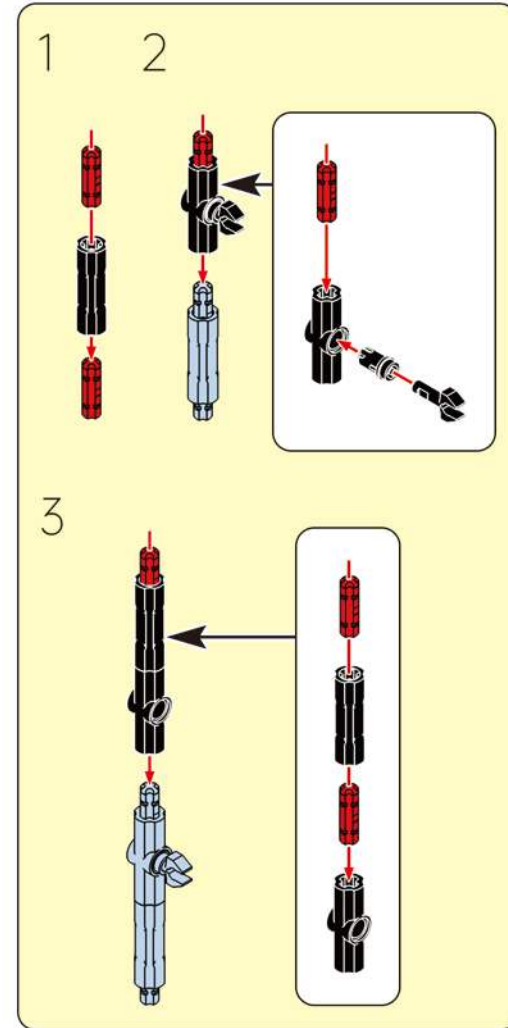

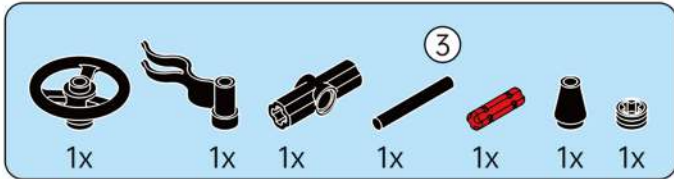

256

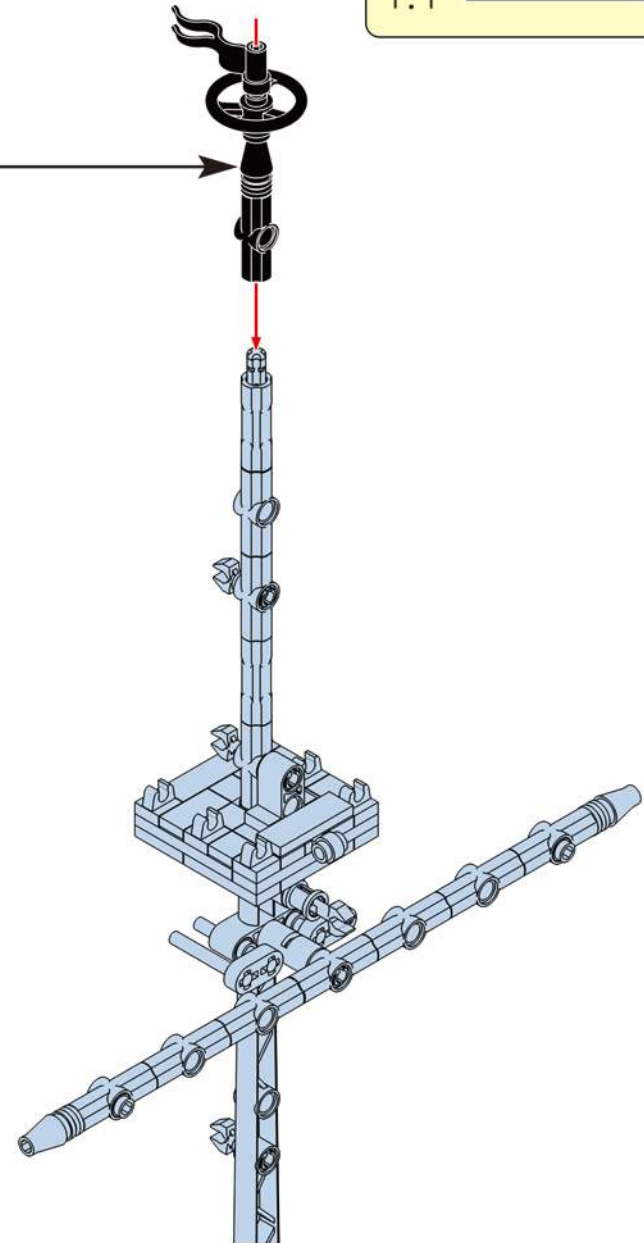
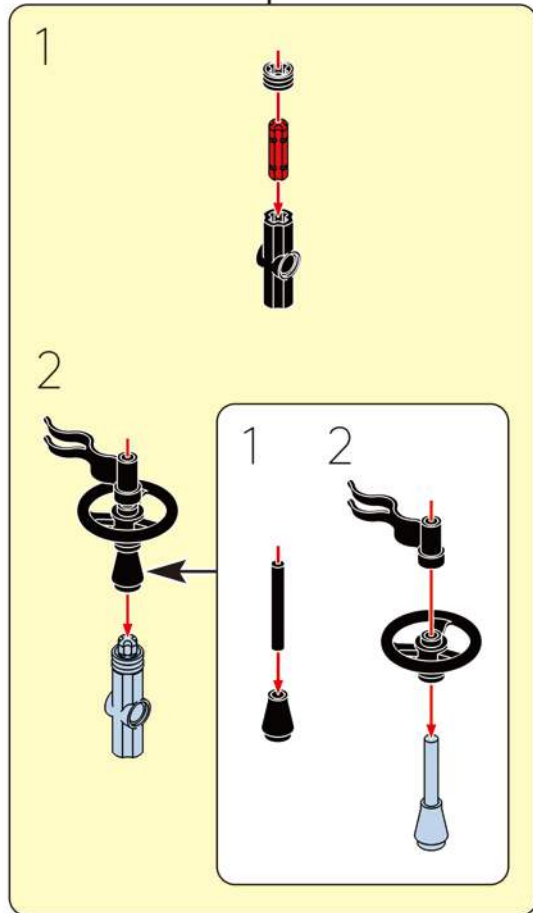



**257**

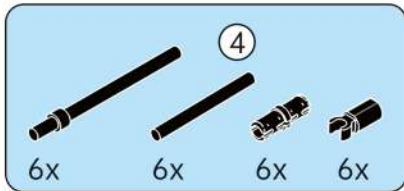
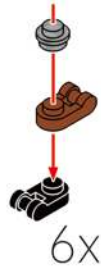

**258**

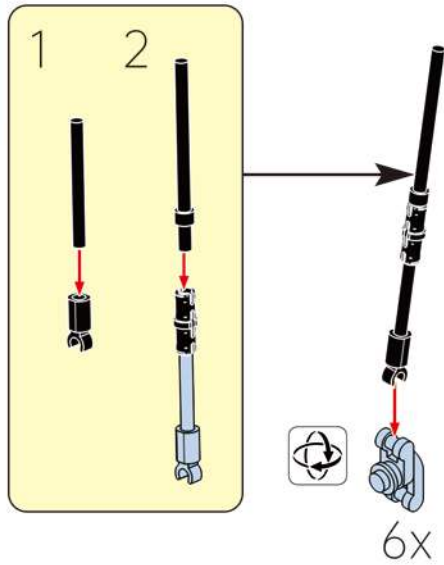

**259**

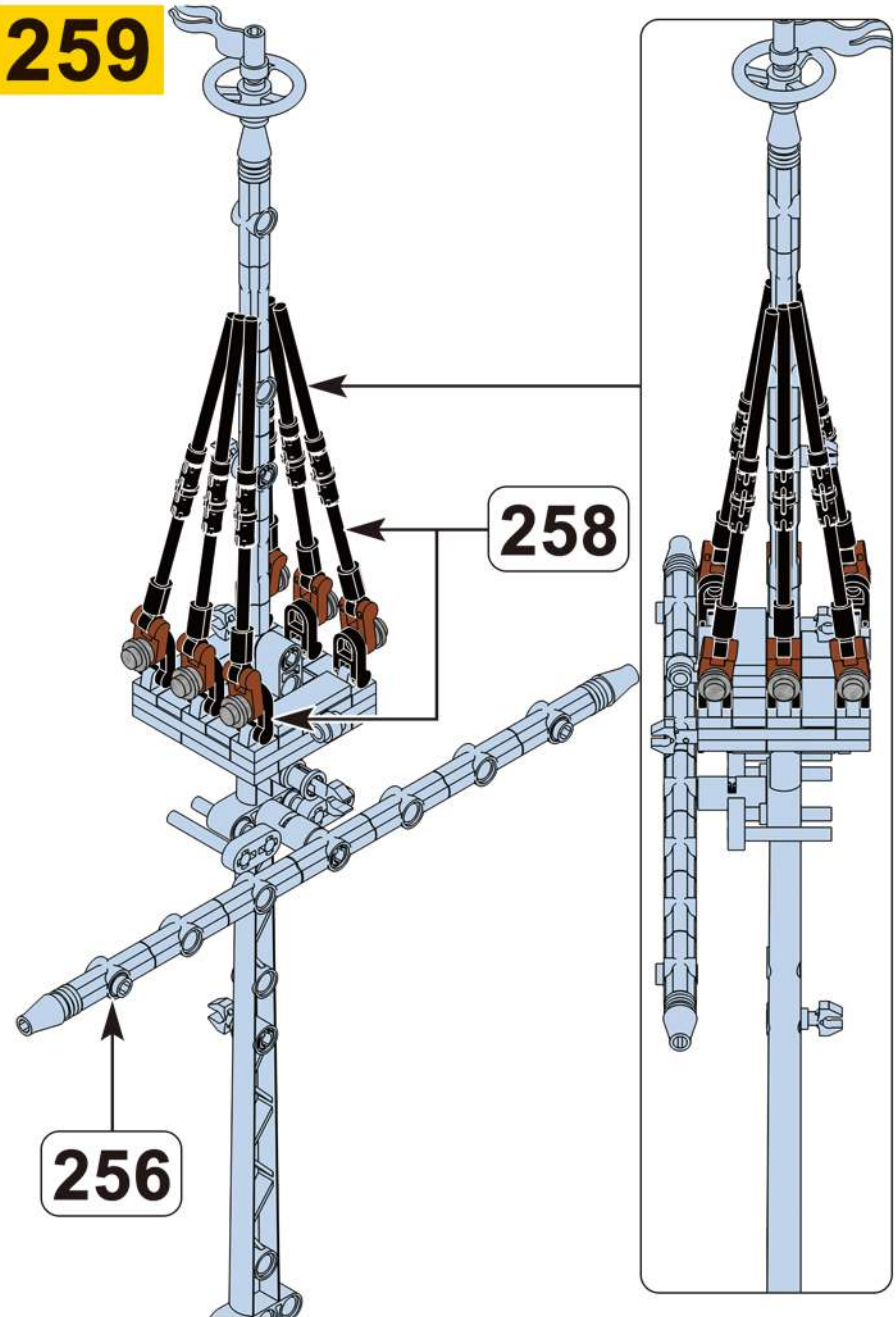

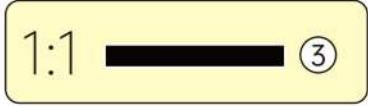
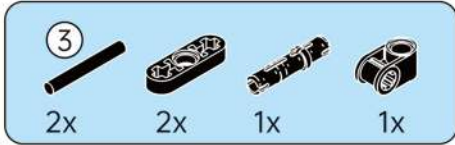

260

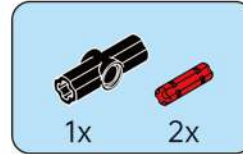
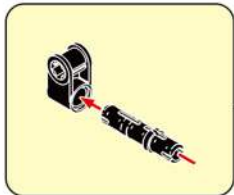
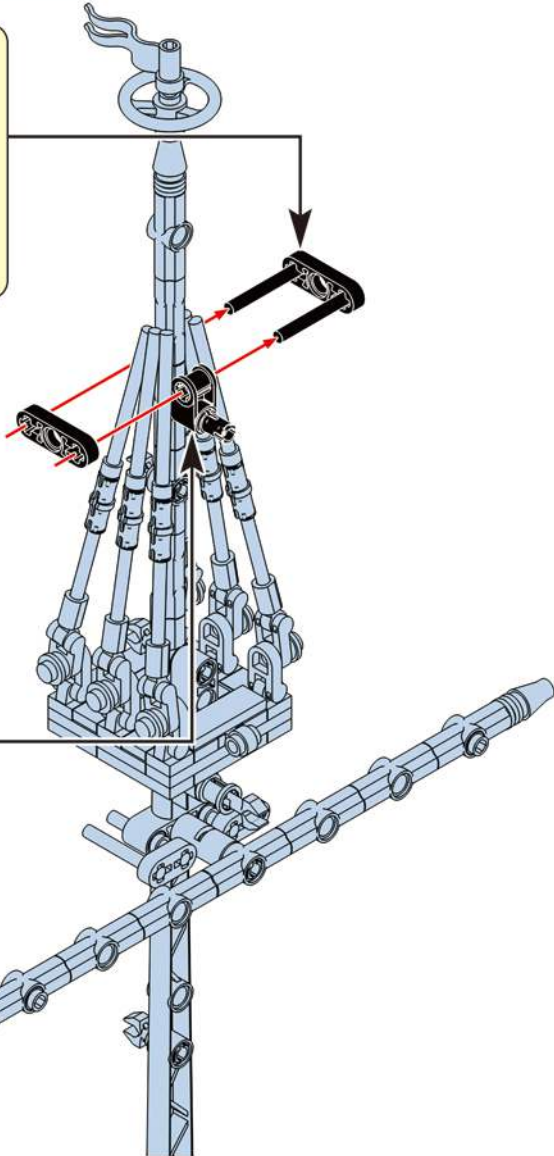
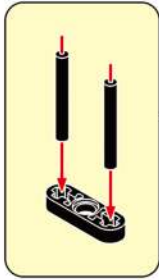

261

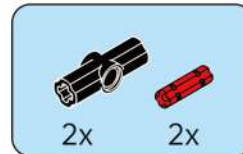

262

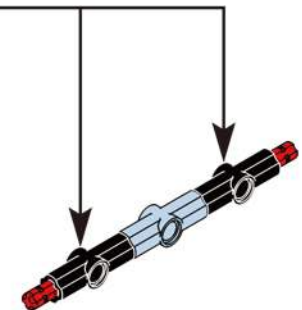
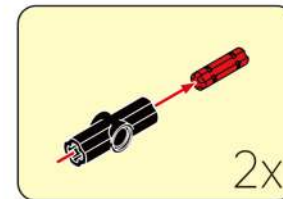

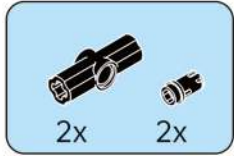

263

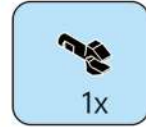
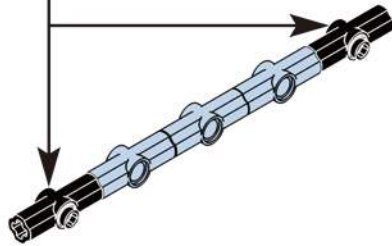
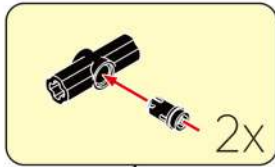

265

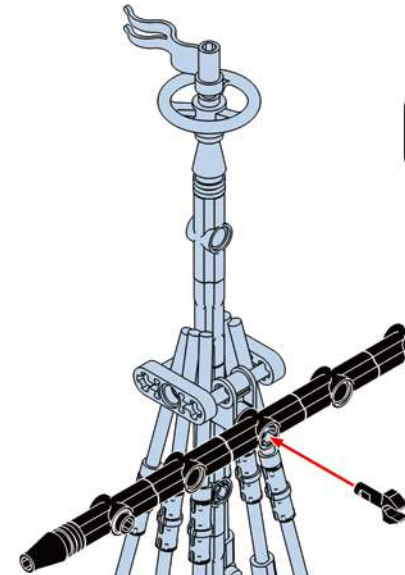

260

264

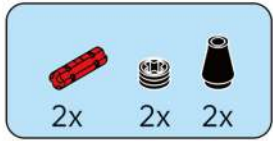

264

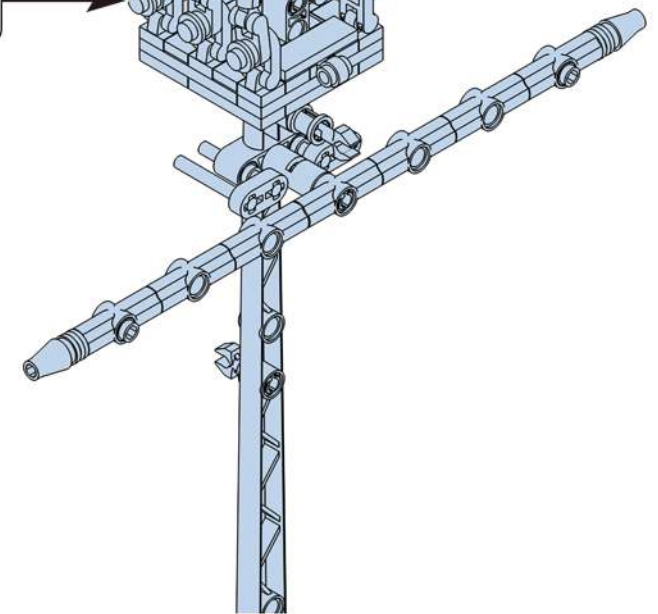
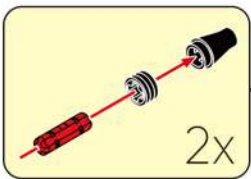
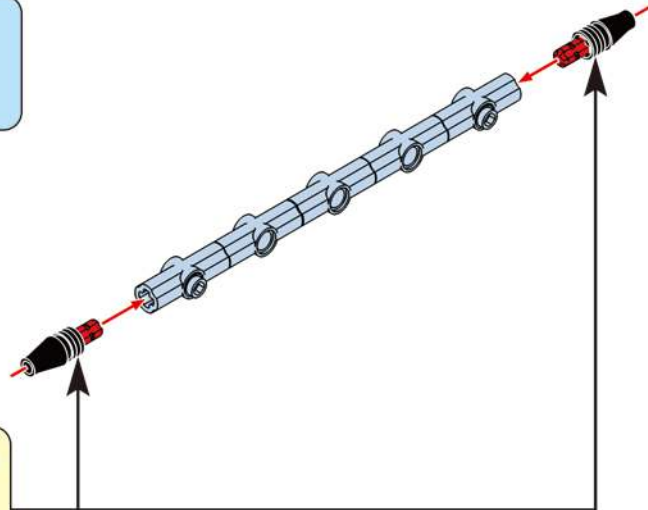

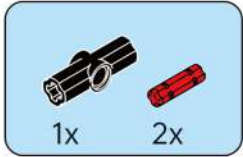

**266**

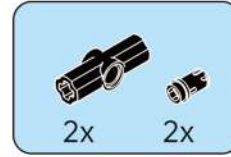

**267**

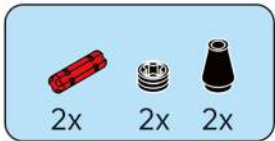
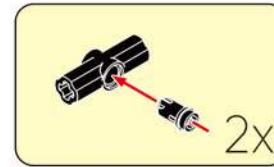
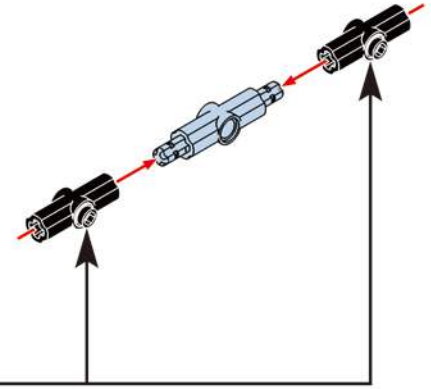

**268**

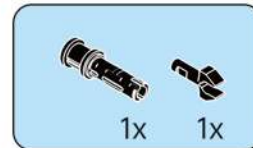
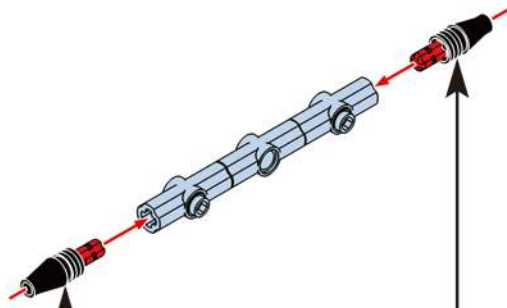

**269**

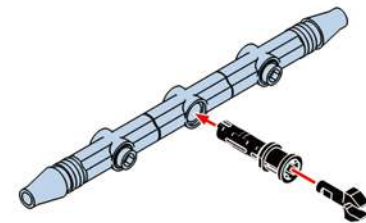

270

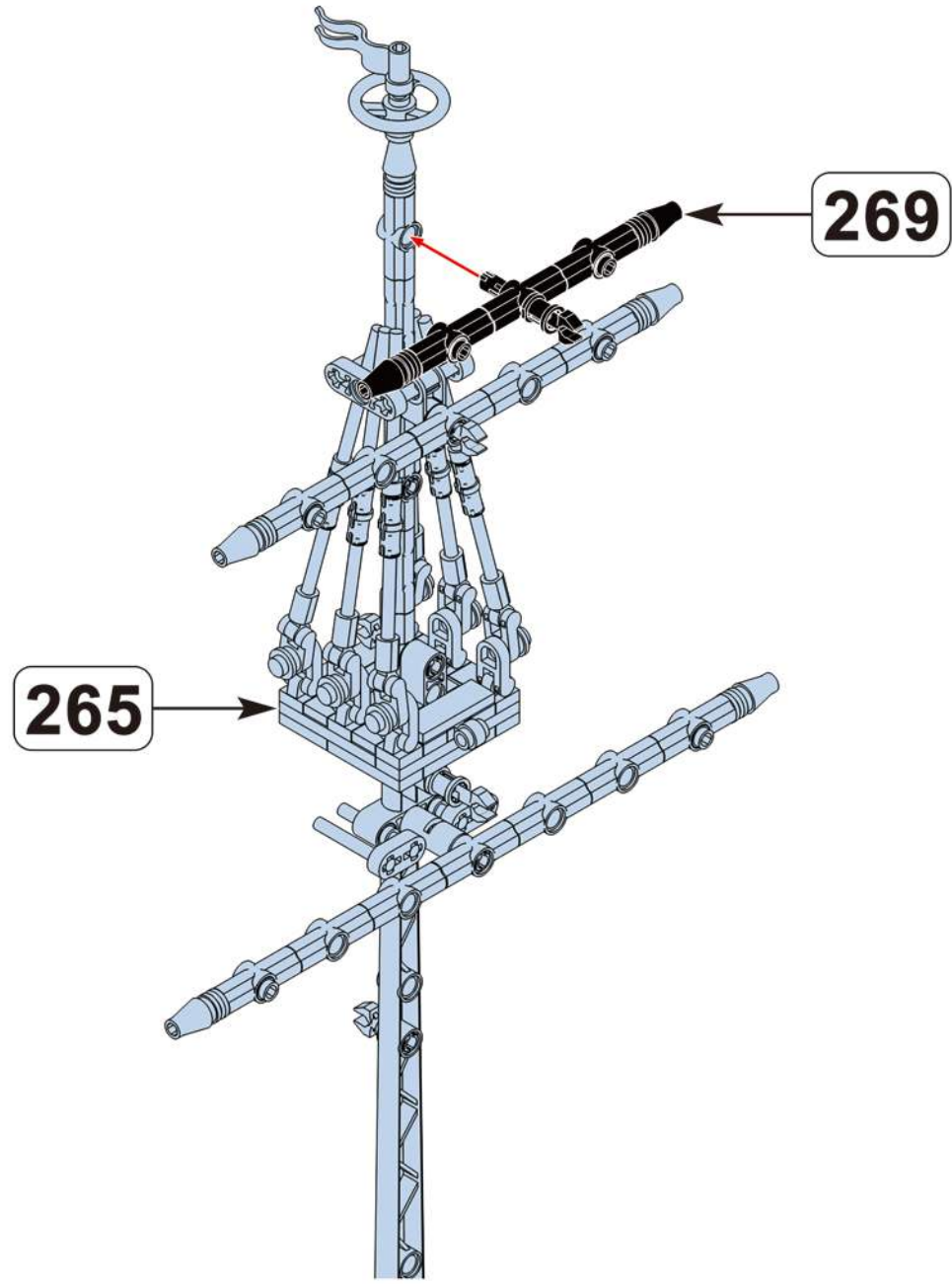



271

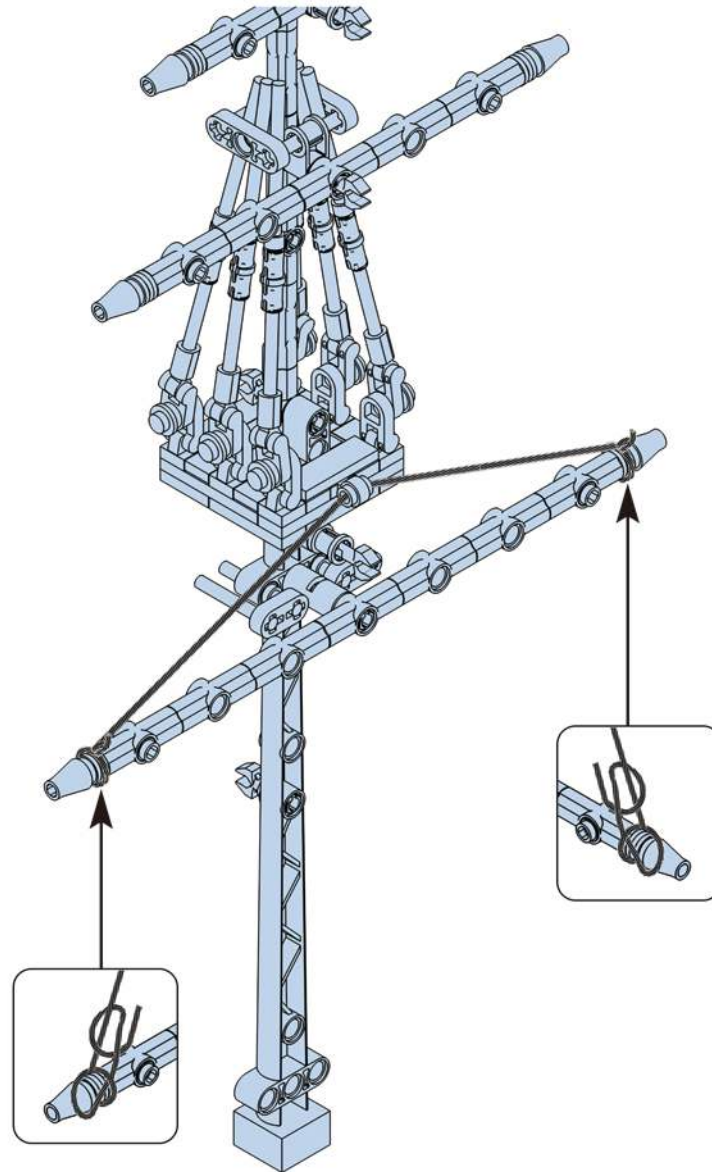

After installing the rope tie, the excess of the rope can be cut with a shear.

Nach der Installation des Seilkaktes kann der Überschuss des Seils mit einer Schere geschnitten werden.

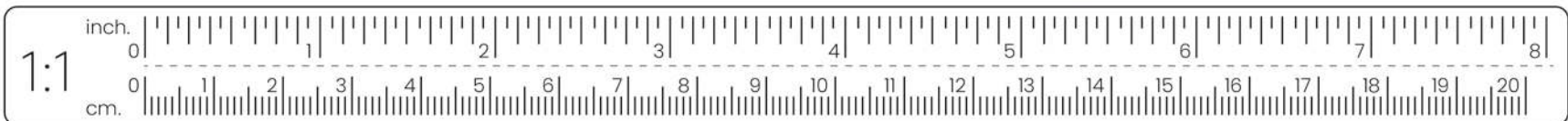

272

241

271

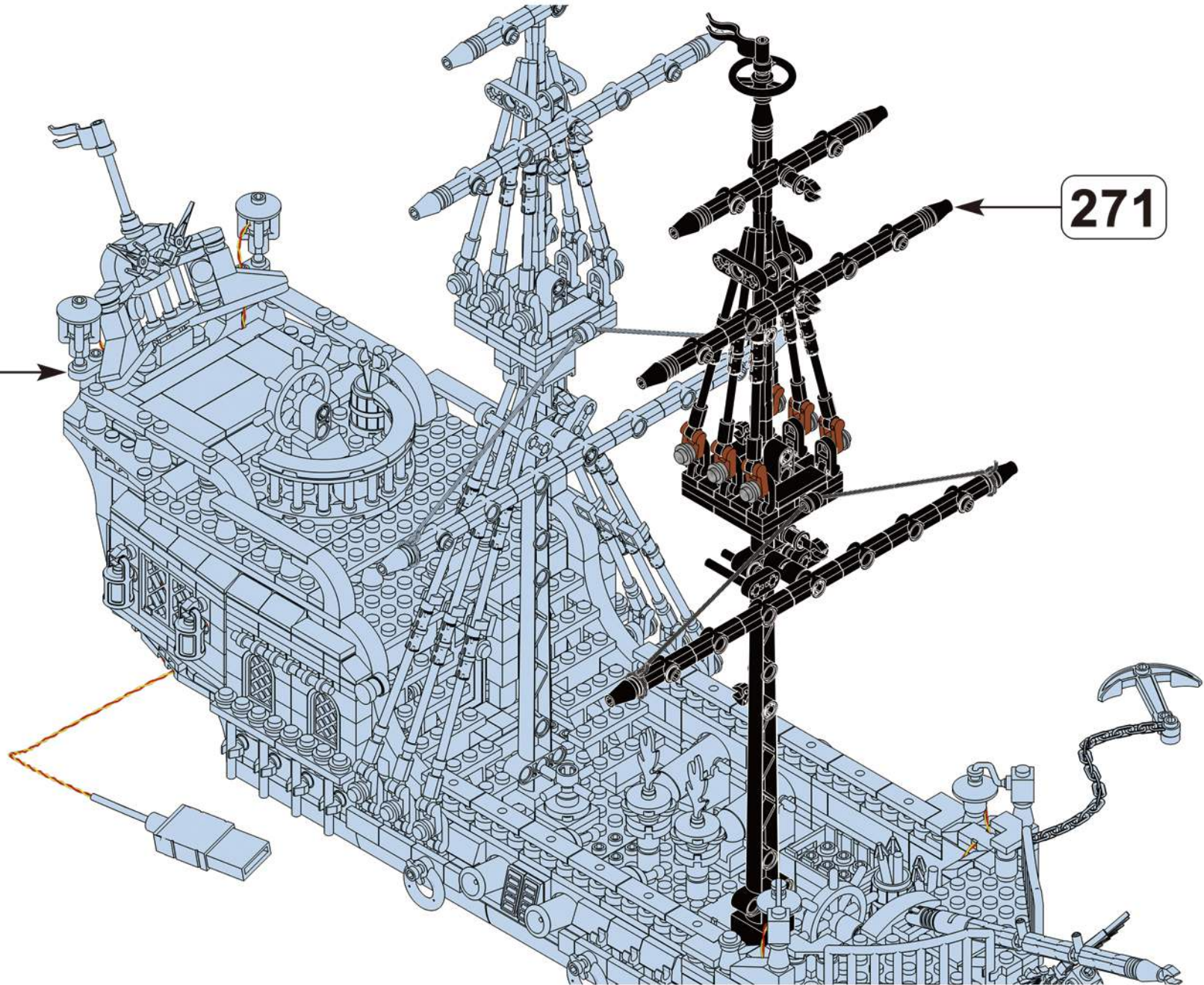



# 273

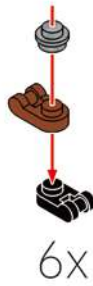

# 274

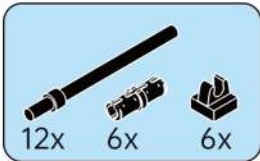
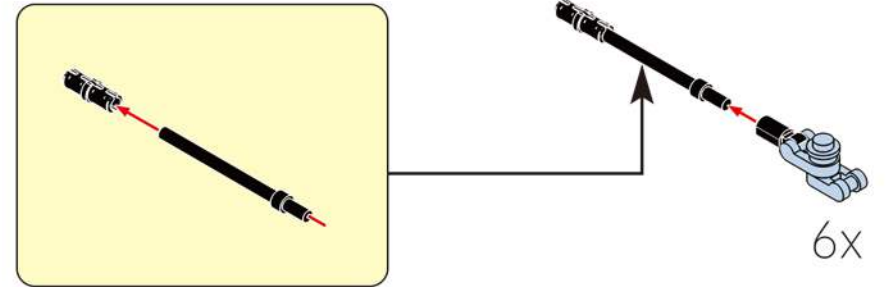

# 275

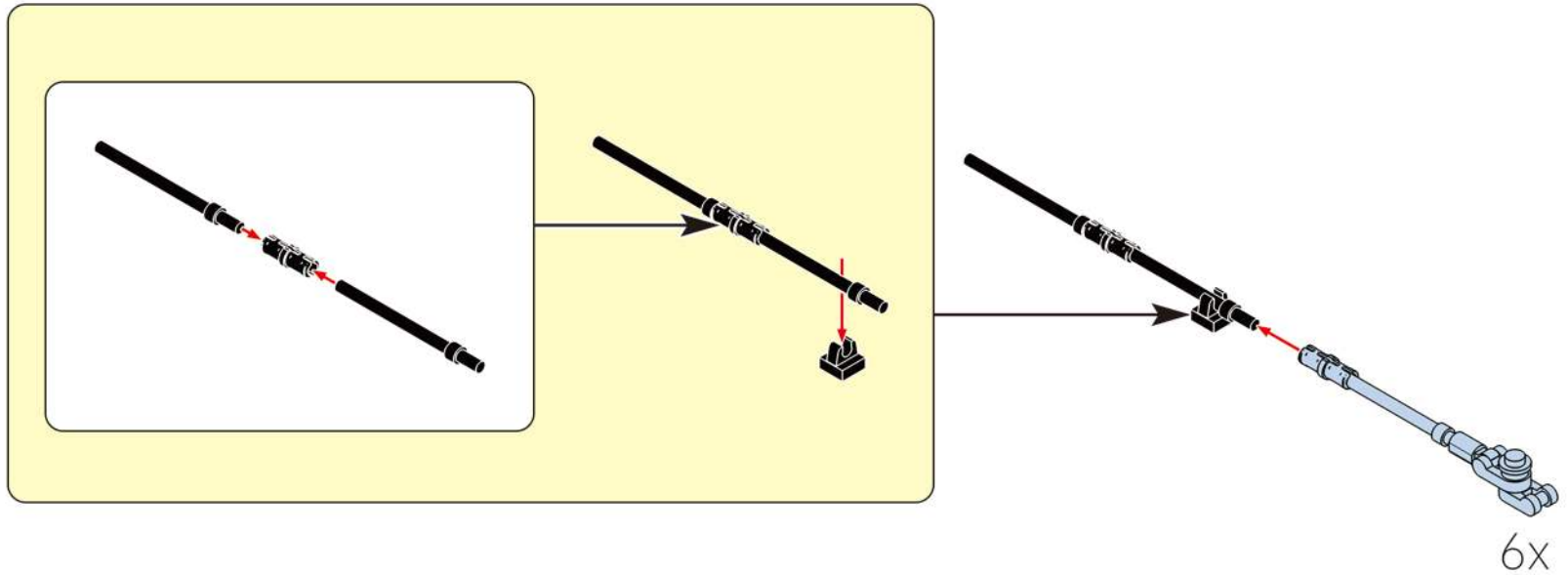

276

272

275

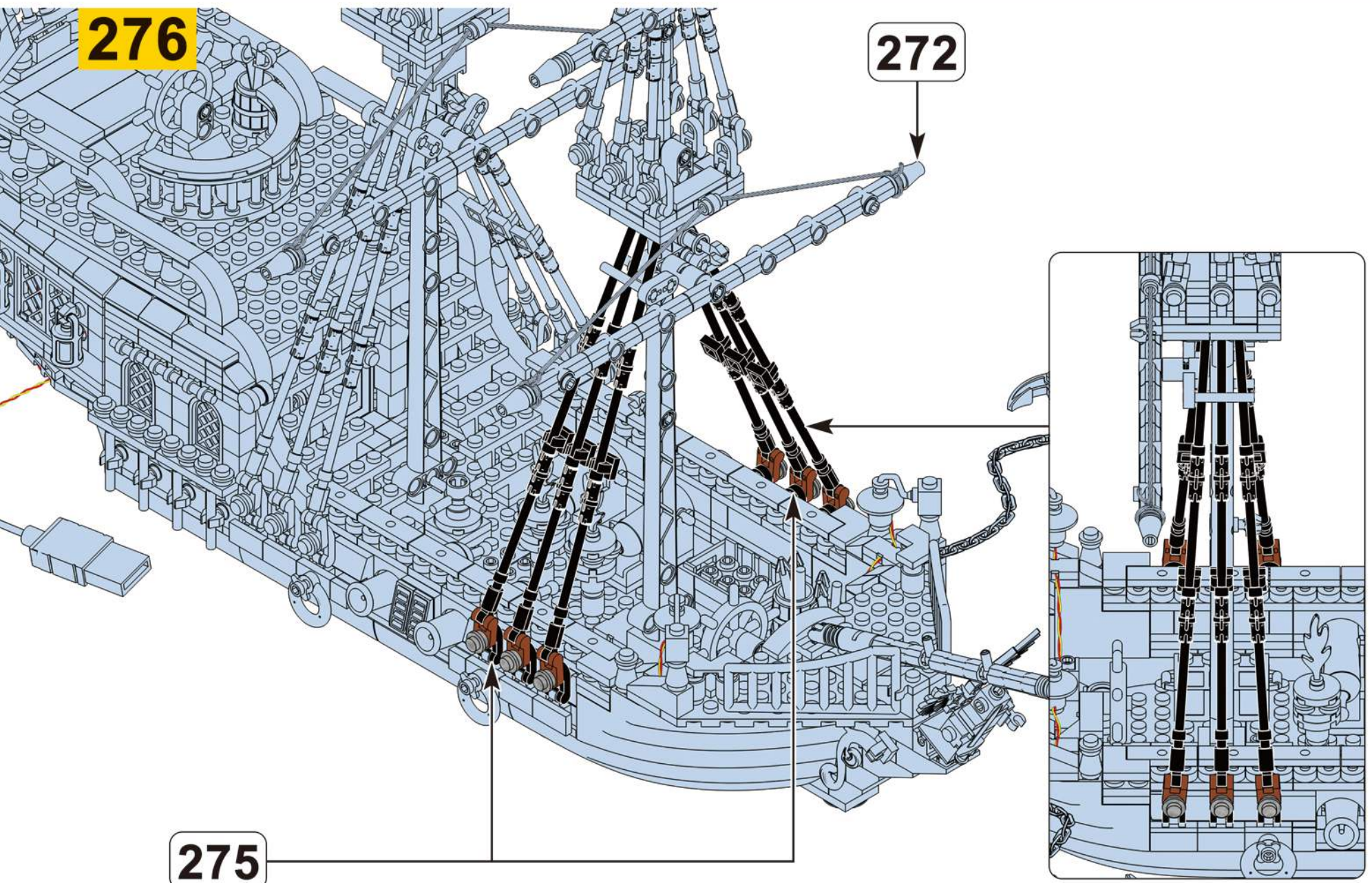



277

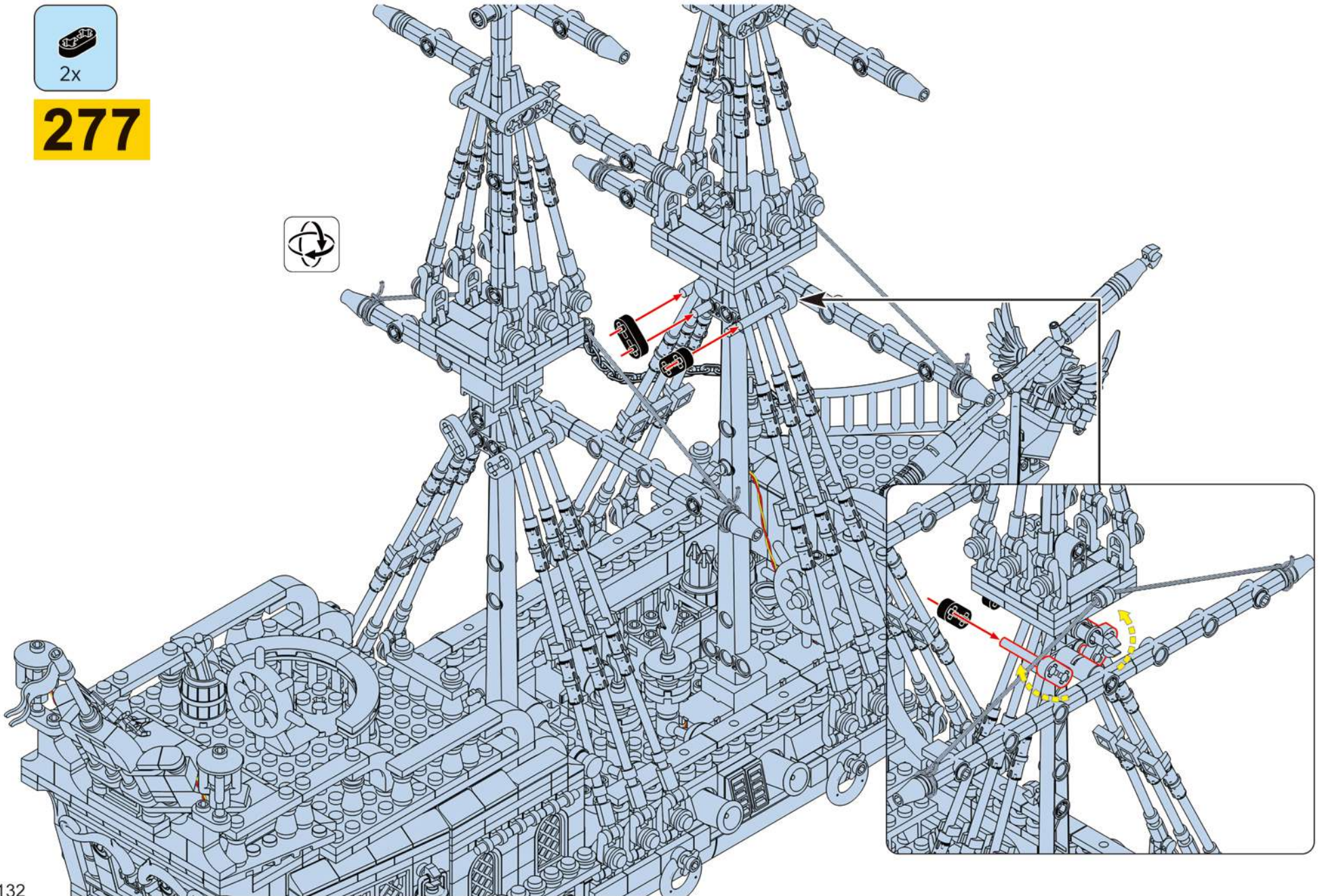

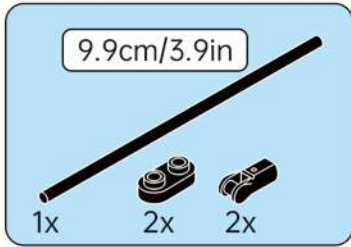

**278**

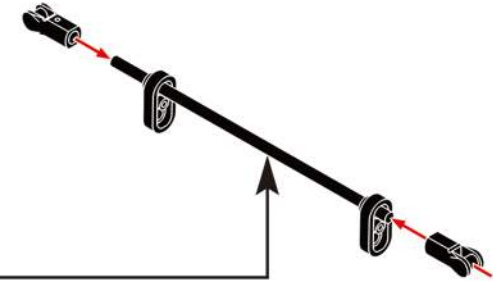
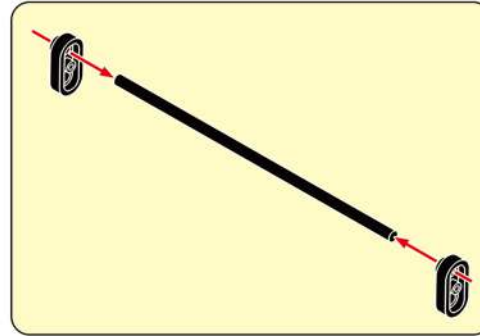

**279**

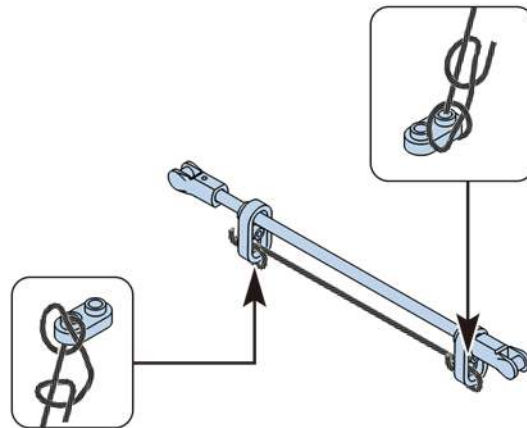

After installing the rope tie, the excess of the rope can be cut with a shear.  
Nach der Installation des Seilkaktes kann der Überschuss des Seils mit einer Schere geschnitten werden.

The length of the hose must be cut to the required length!  
Die Länge des Schlauchs muss auf die erforderliche Länge geschnitten werden!

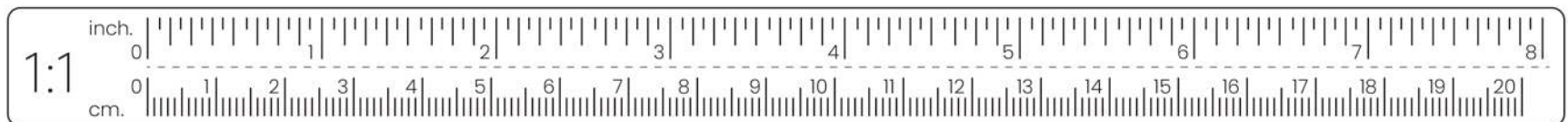

**280**

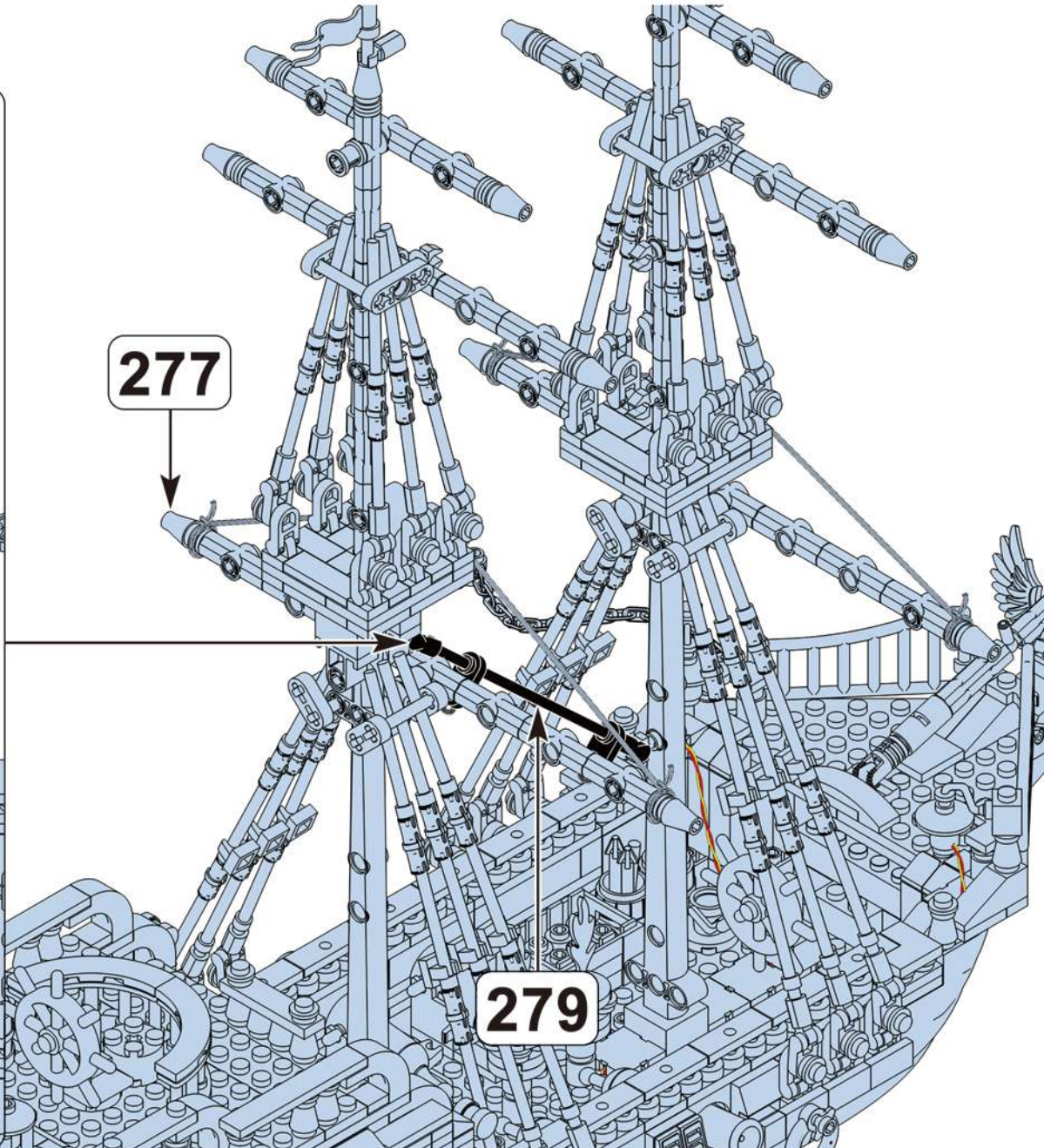
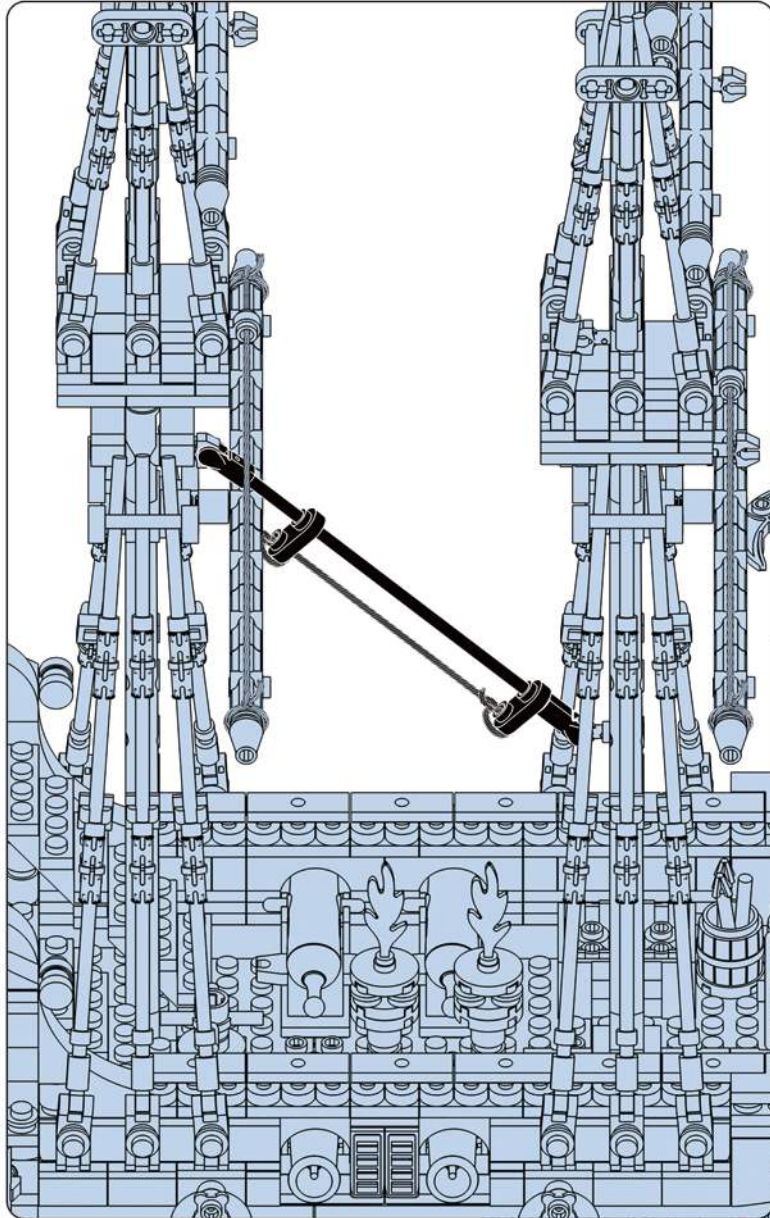

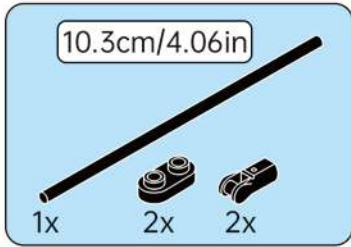

281

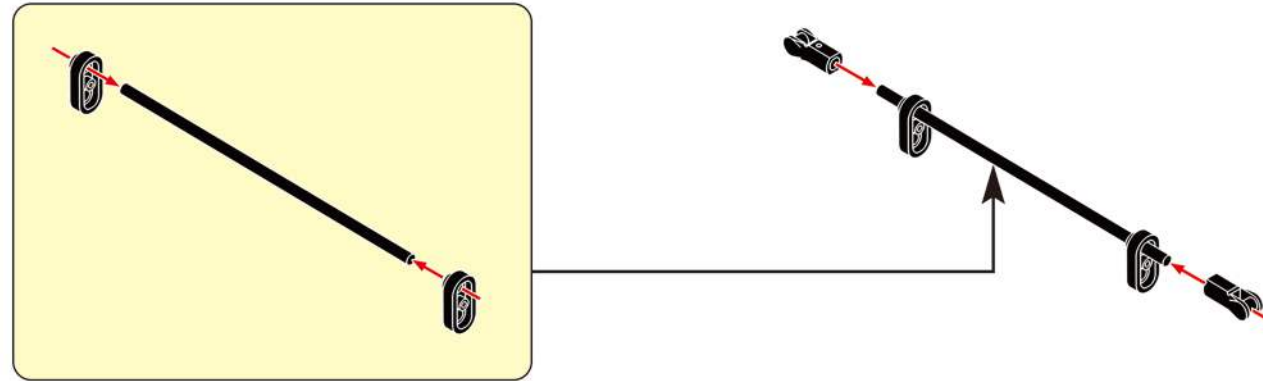

282

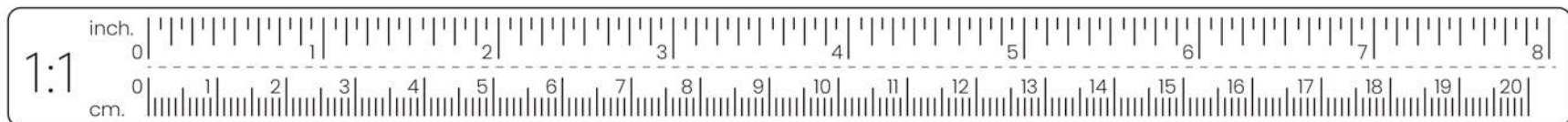
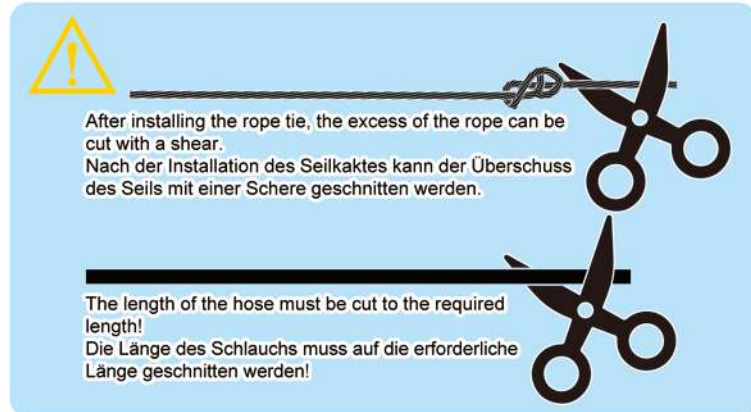
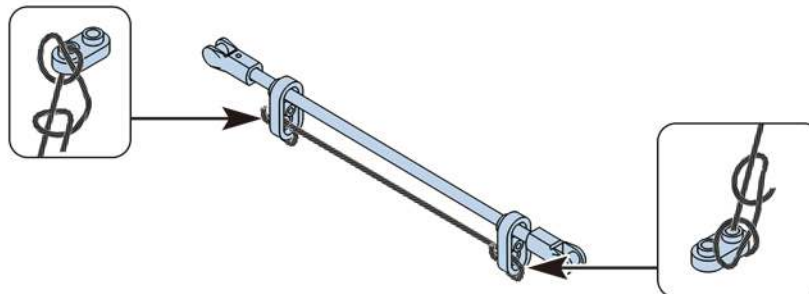

**283**

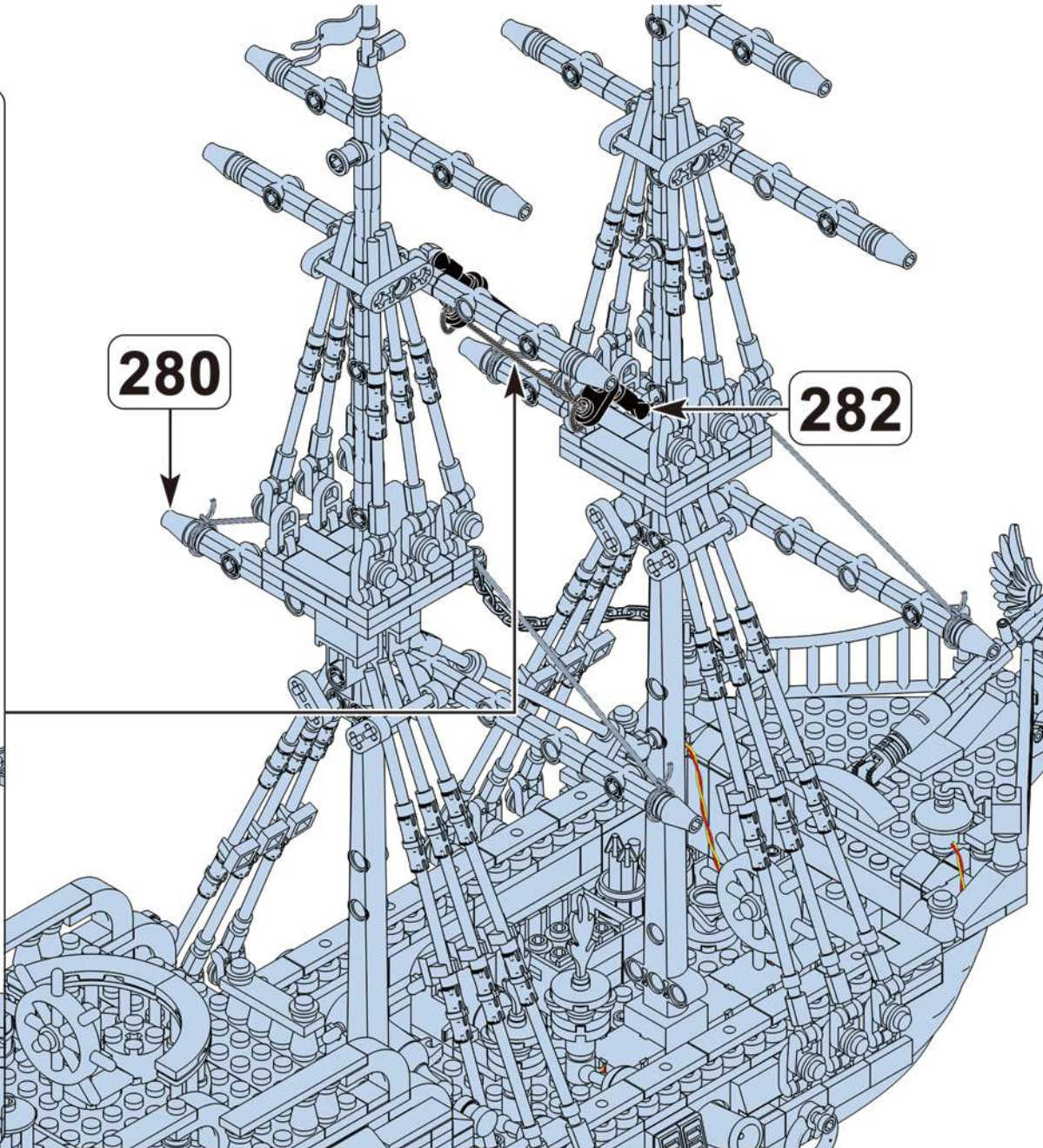
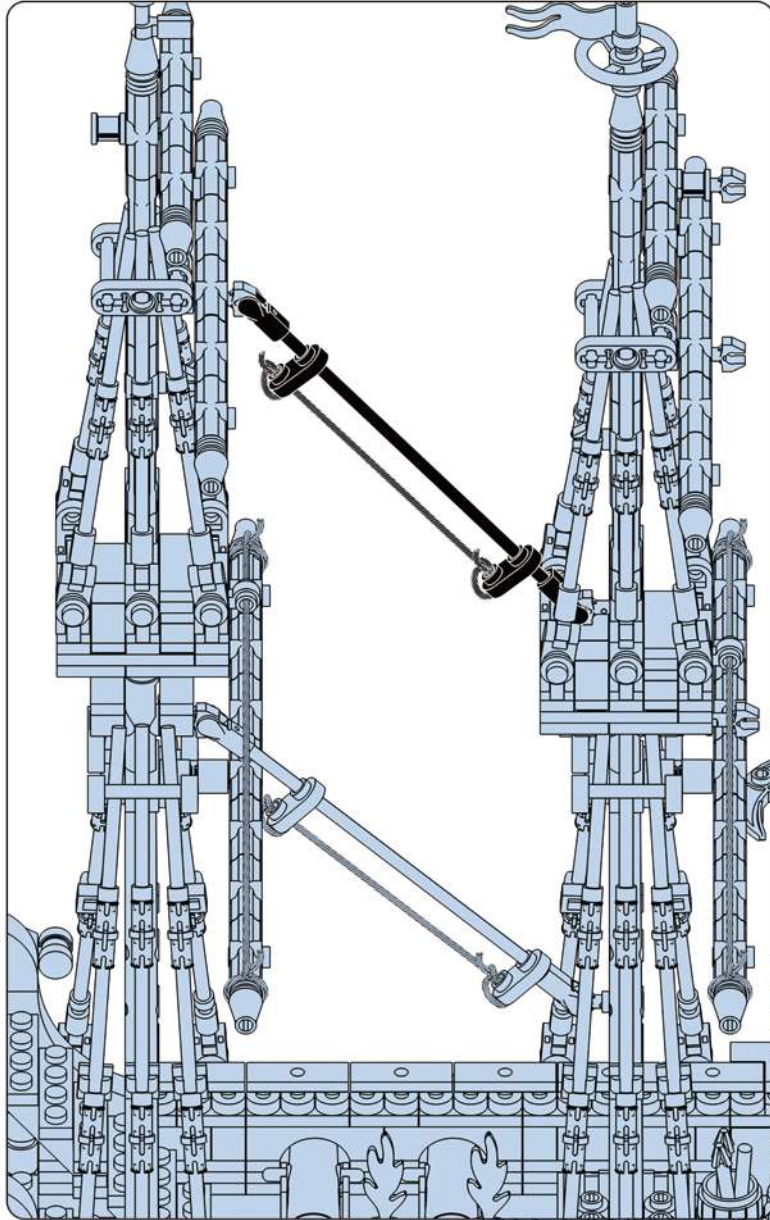

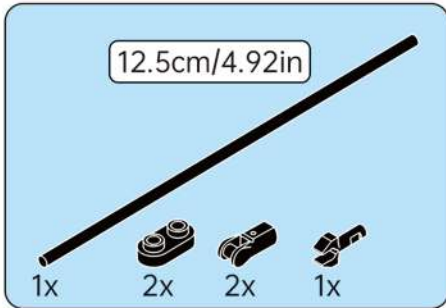

284

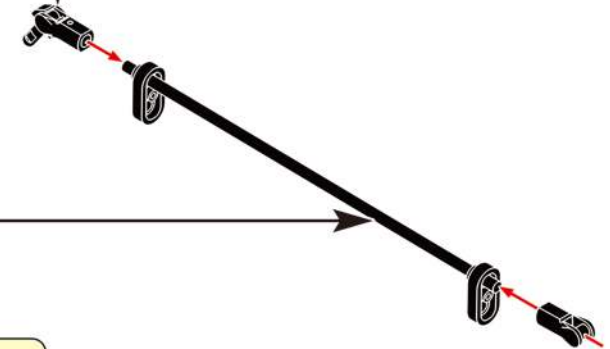
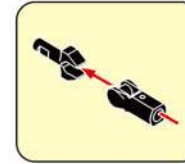
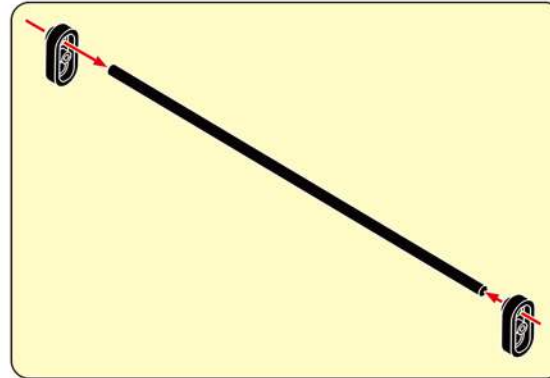

285

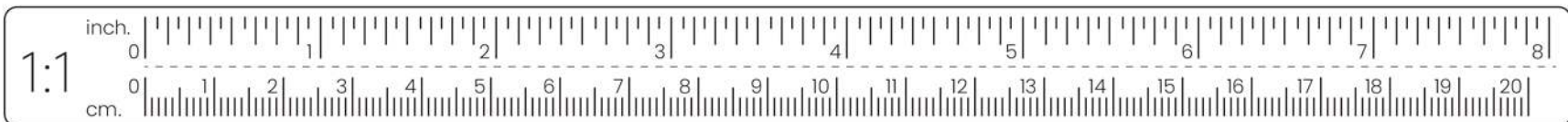
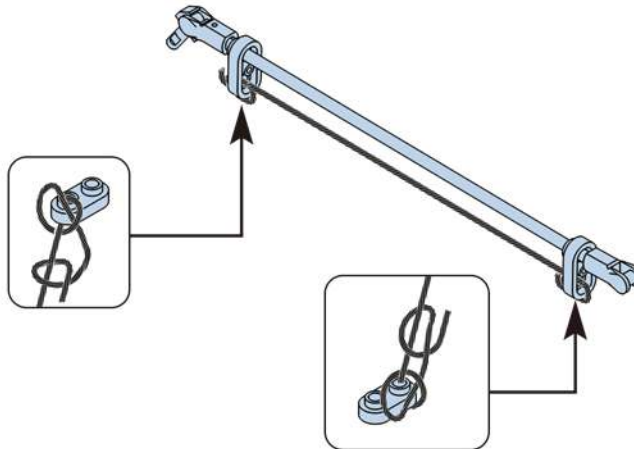

# 286

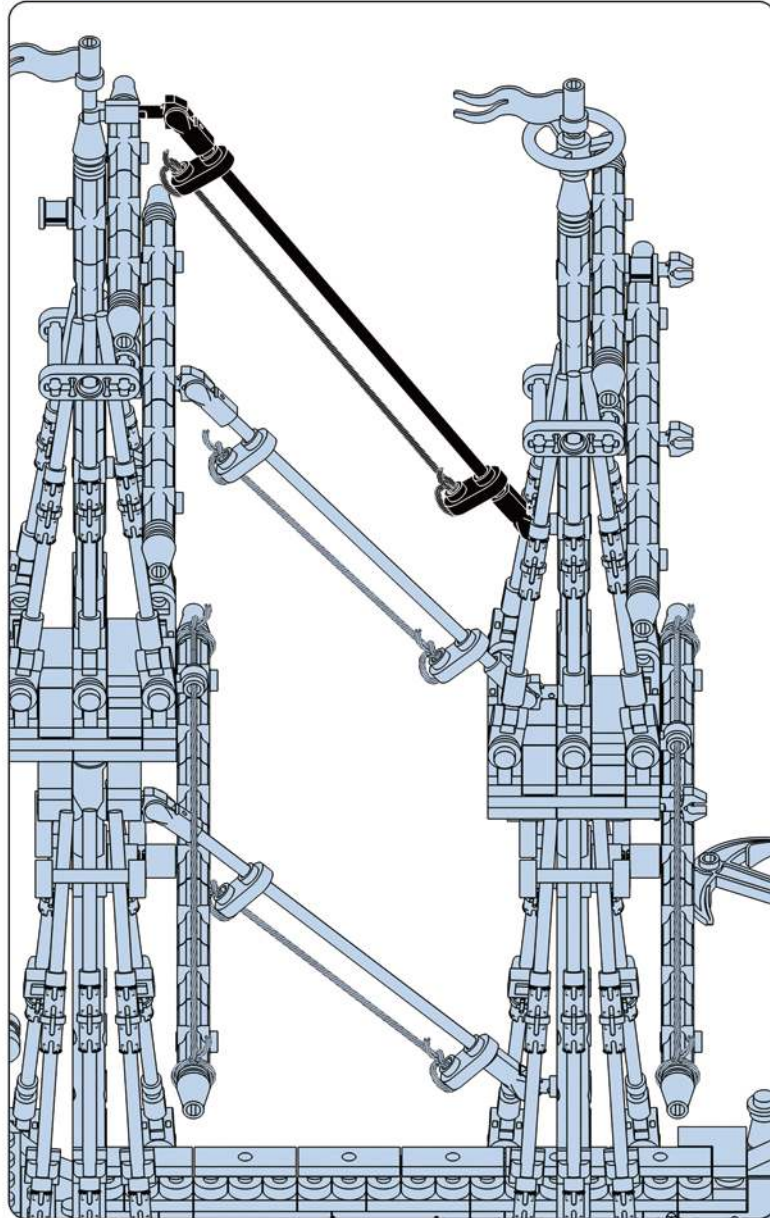

283

285

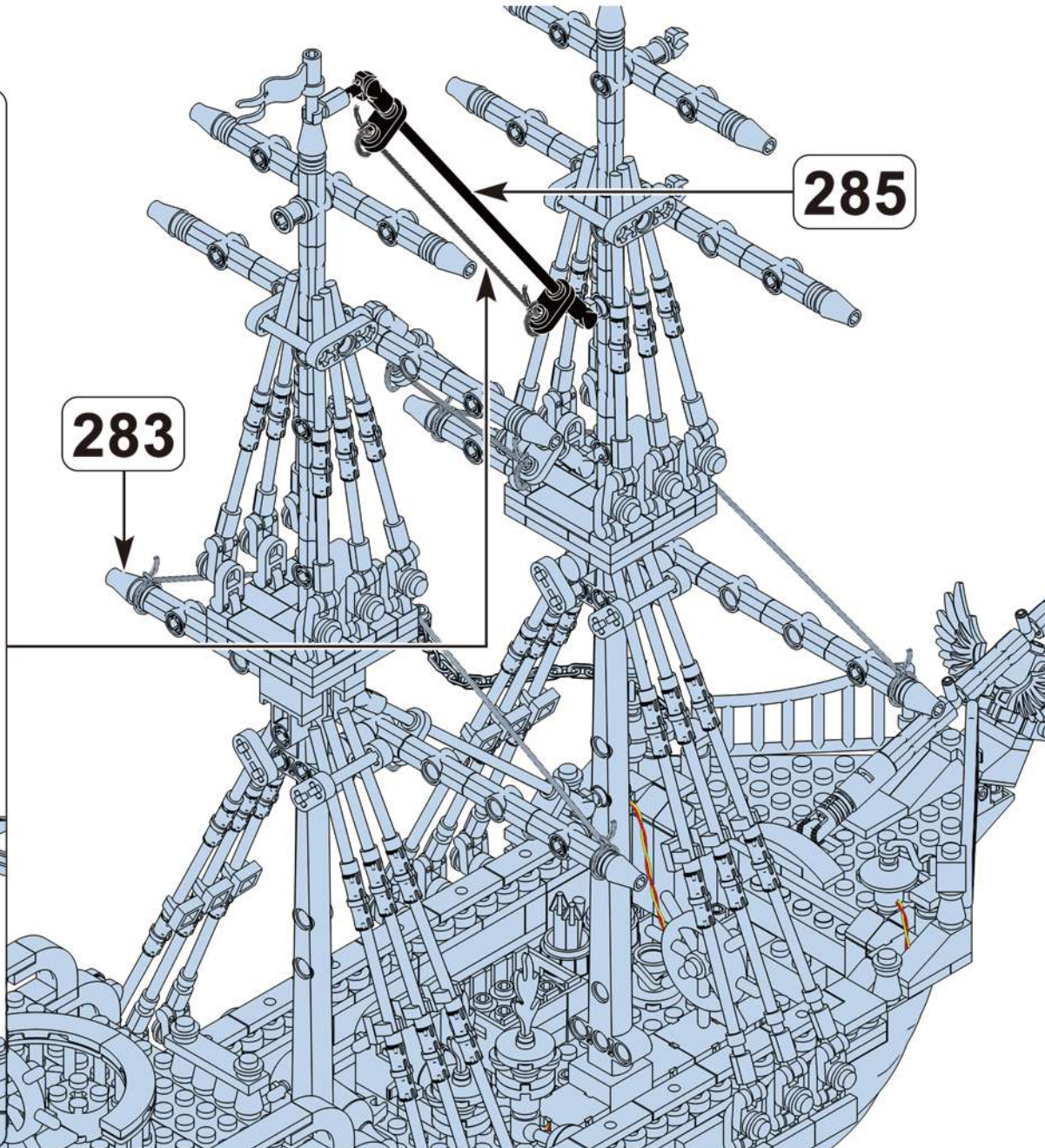

8.1cm/3.19in

1x 1x 2x

287

The length of the hose must be cut to the required length!  
Die Länge des Schlauchs muss auf die erforderliche Länge geschnitten werden!

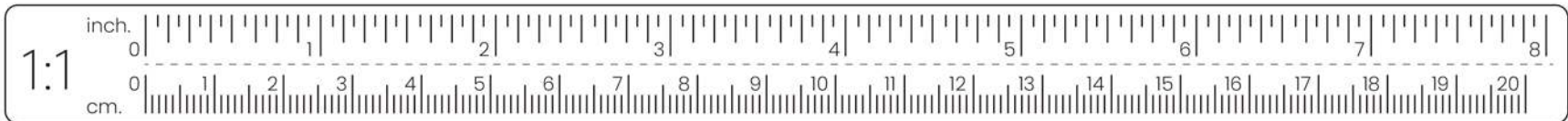
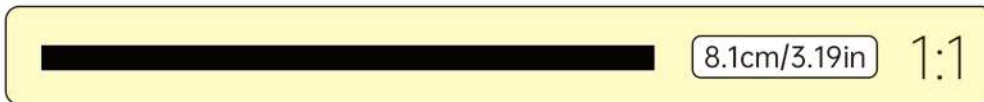
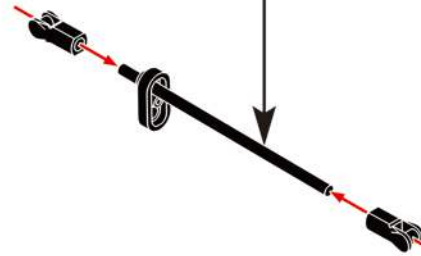
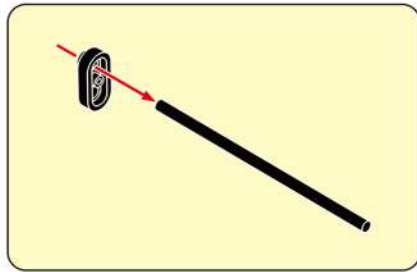

11.9cm/4.69in

1x 2x 2x

The length of the hose must be cut to the required length!  
Die Länge des Schlauchs muss auf die erforderliche Länge geschnitten werden!

288

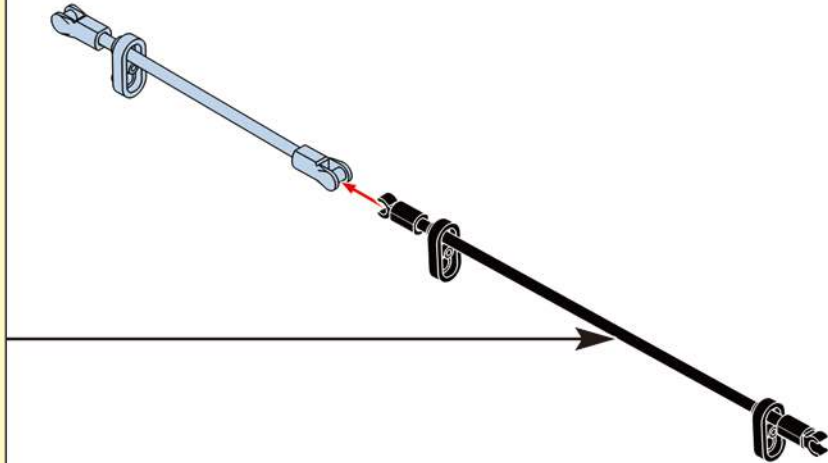
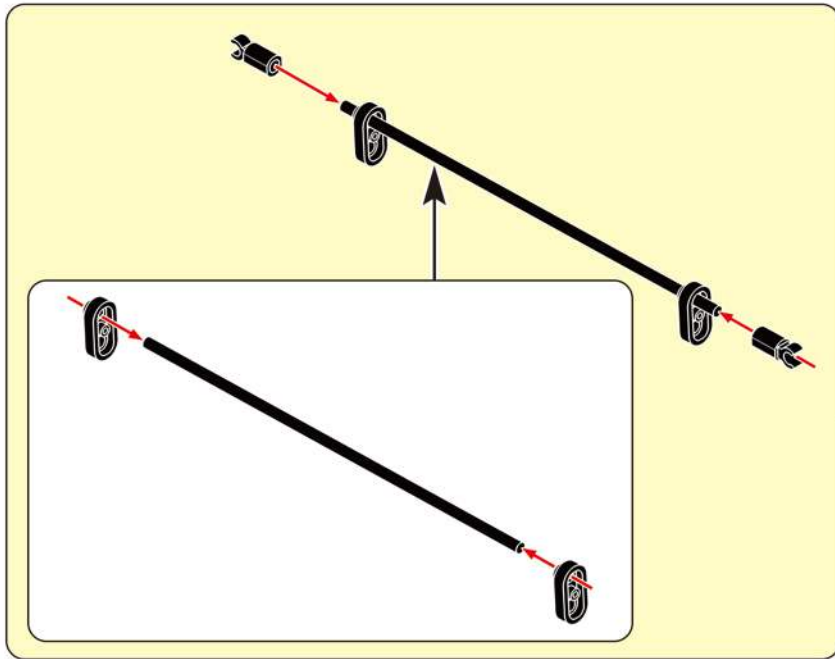

11.9cm/4.69in 1:1



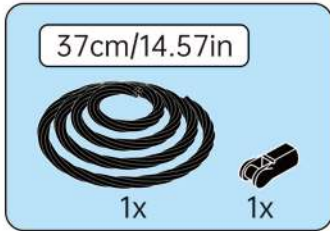

# 289

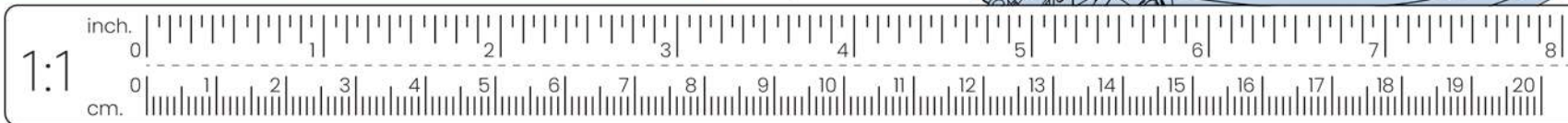
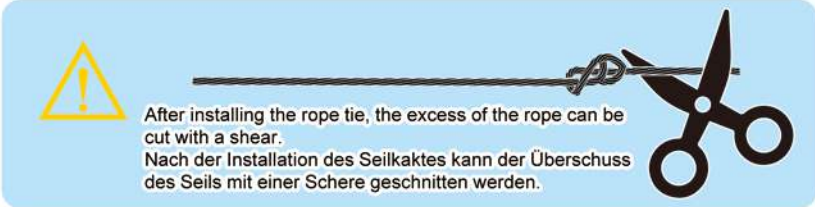
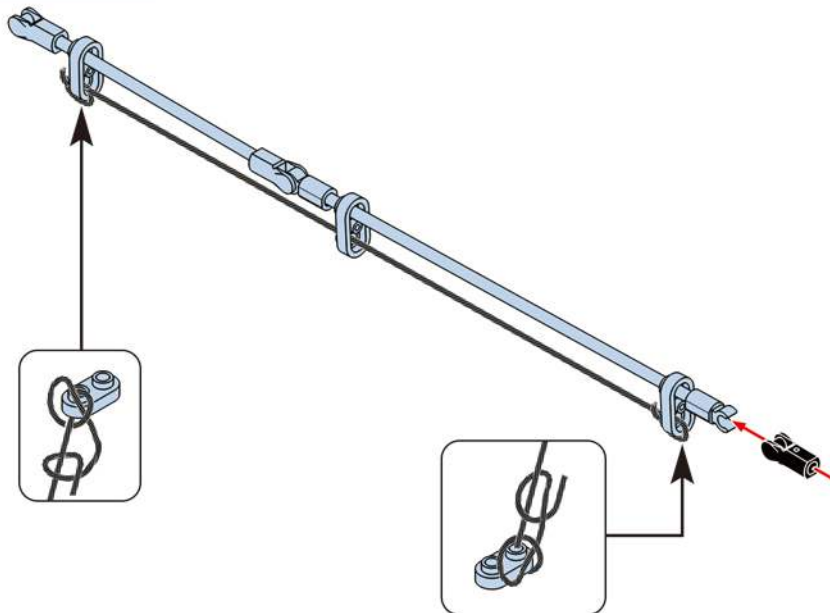

# 290

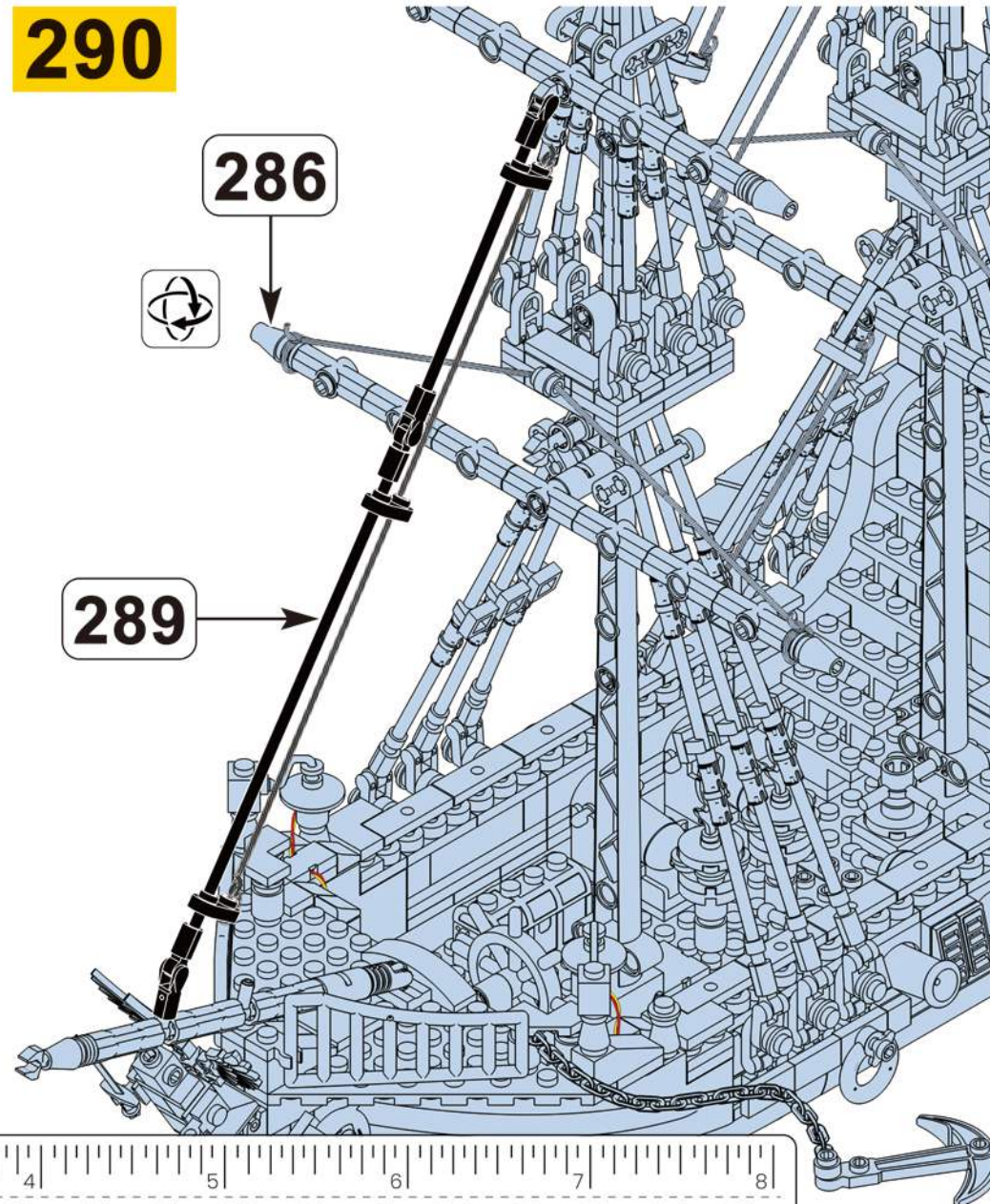

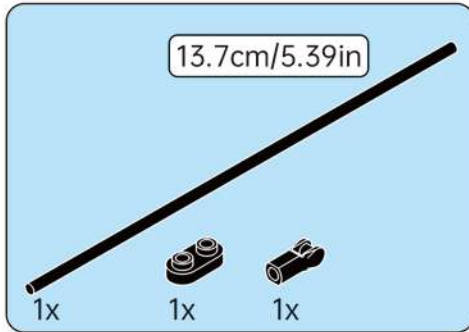

291

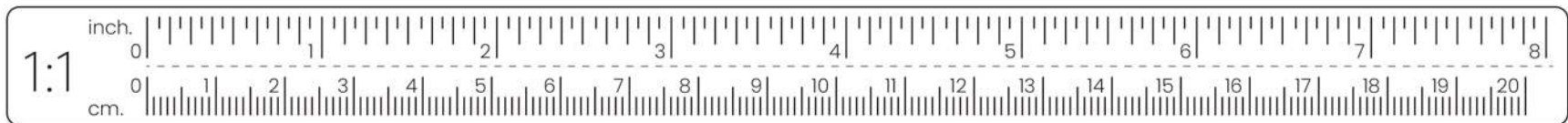
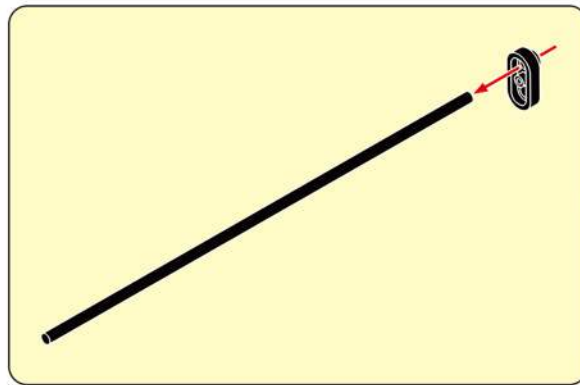
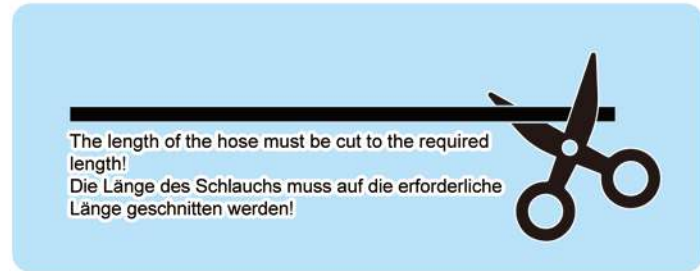

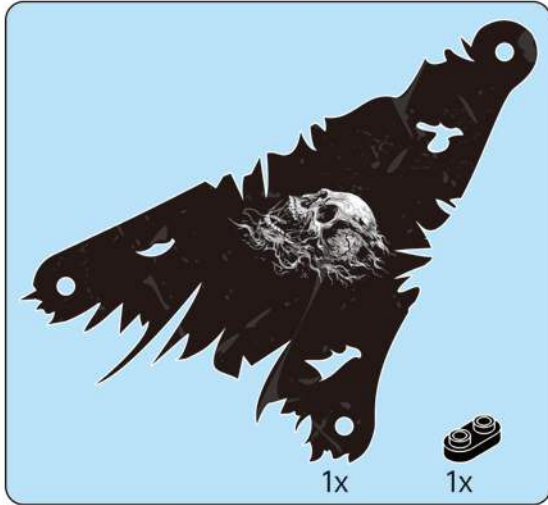

292

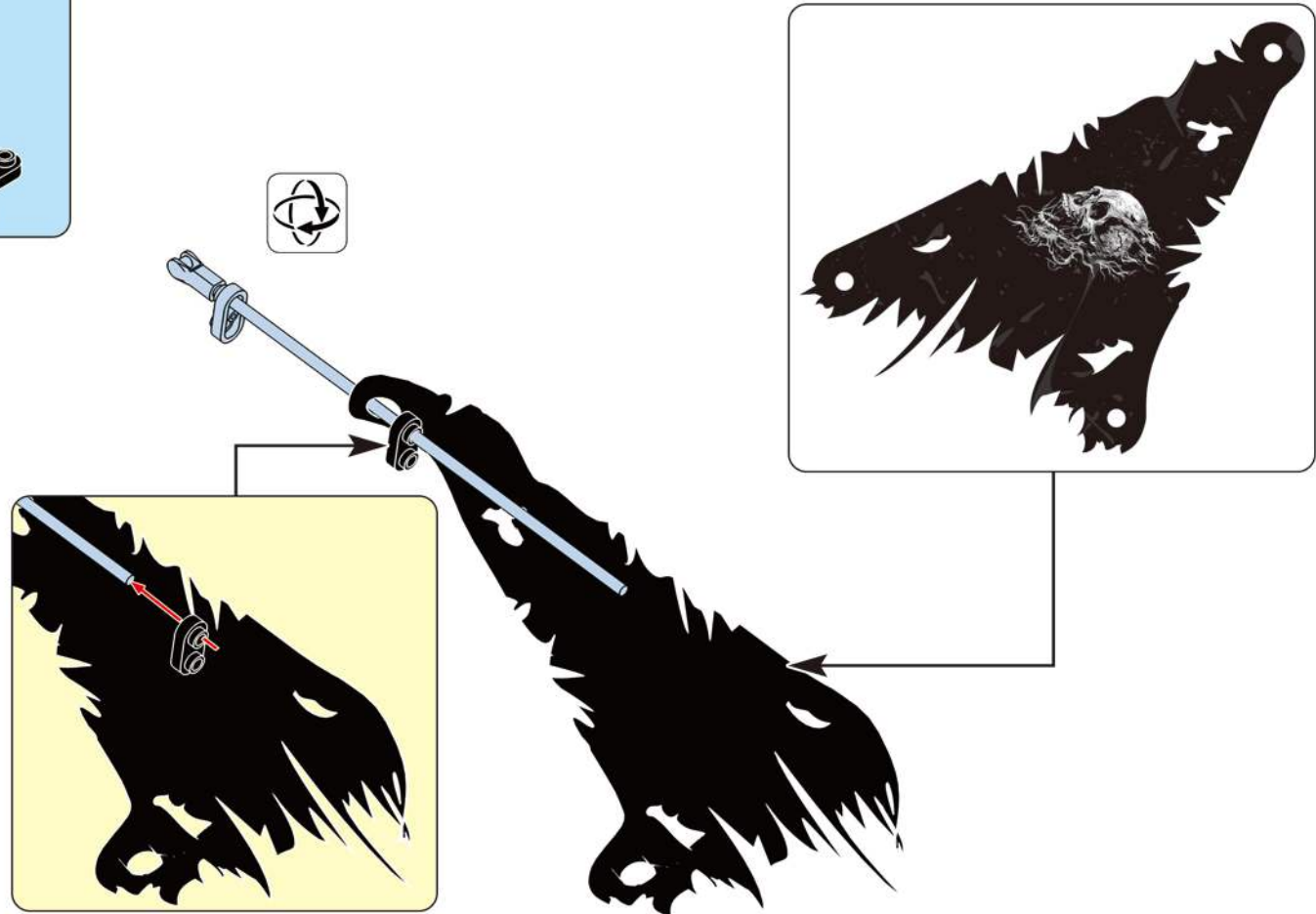

12.8cm/5.04in

1x 1x 2x 1x

293

The length of the hose must be cut to the required length!  
Die Länge des Schlauchs muss auf die erforderliche Länge geschnitten werden!

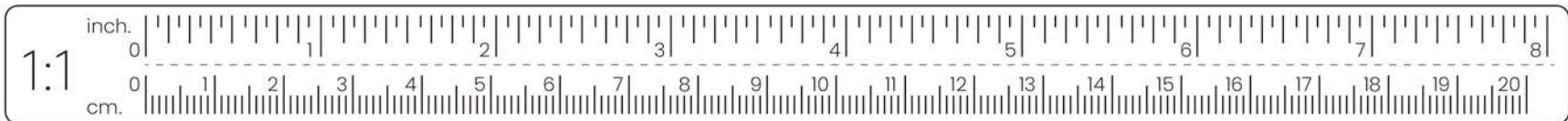
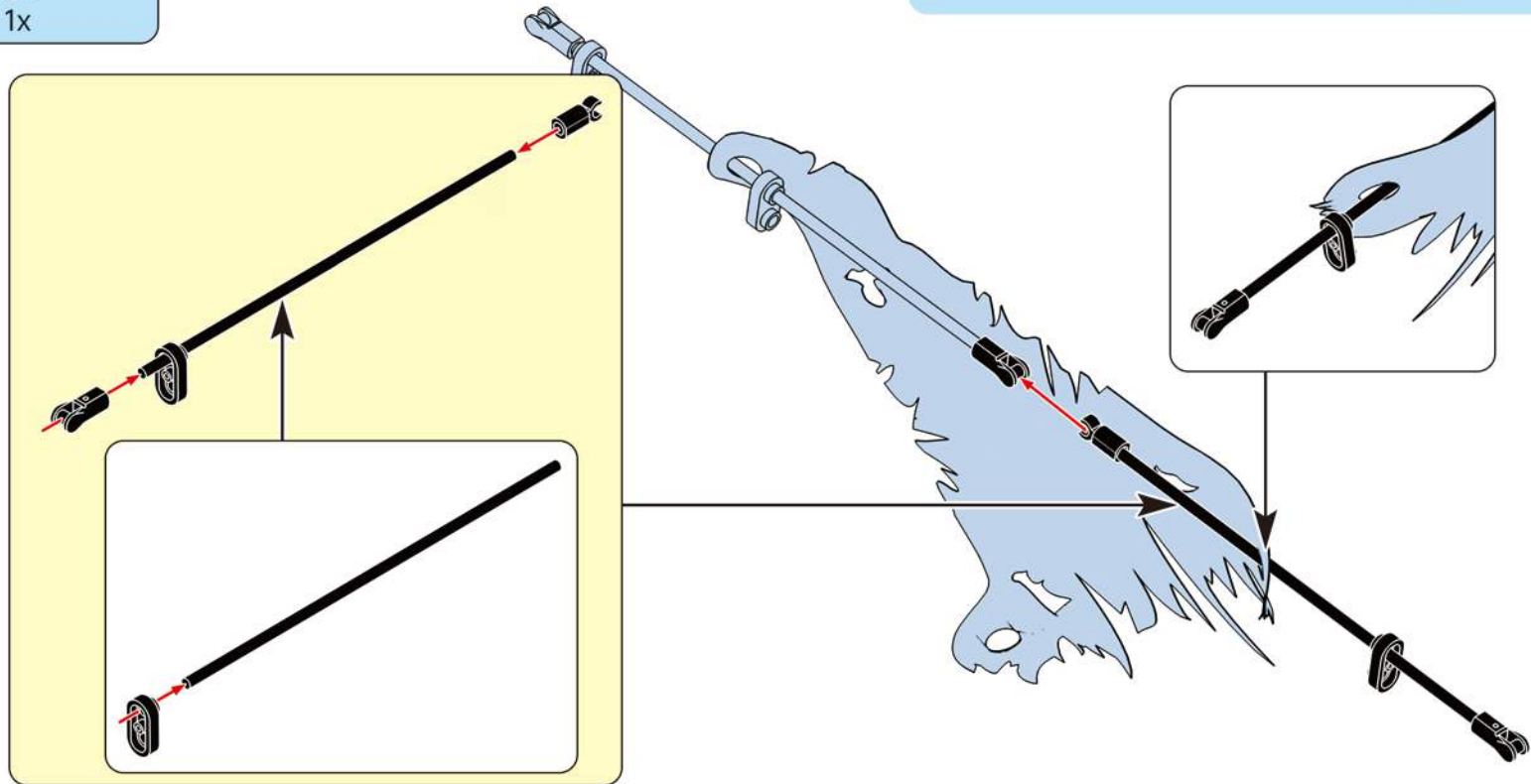



294

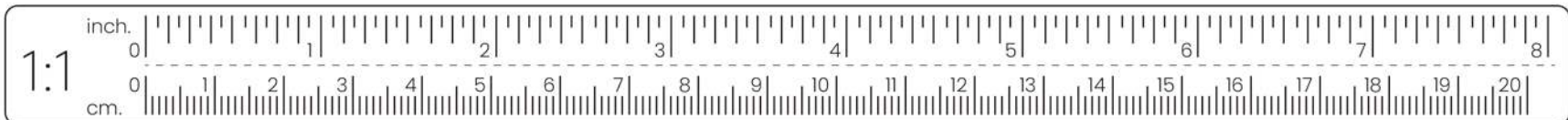
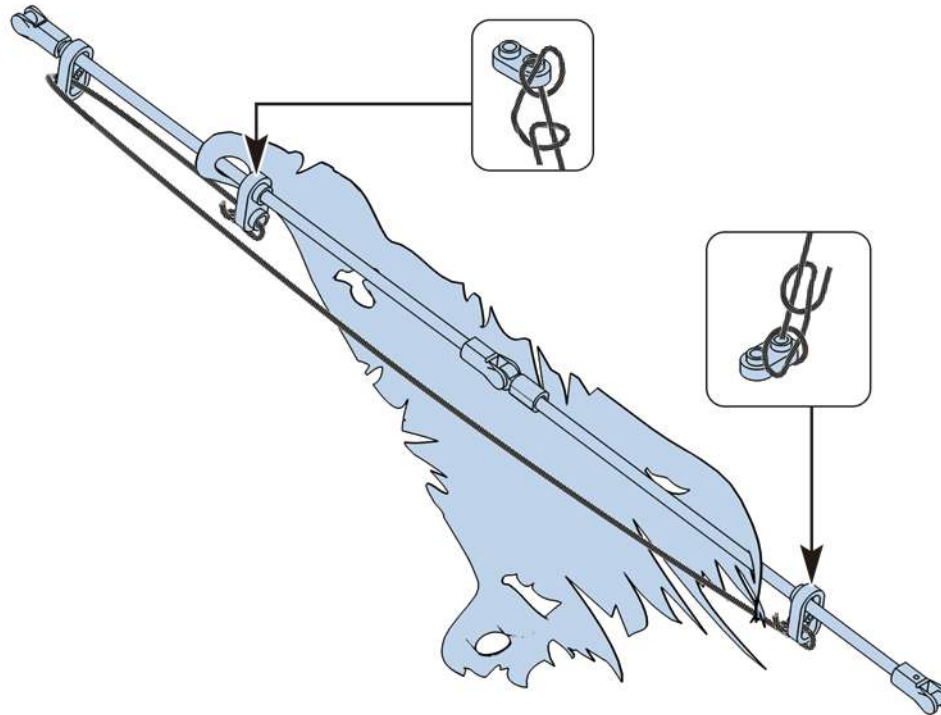
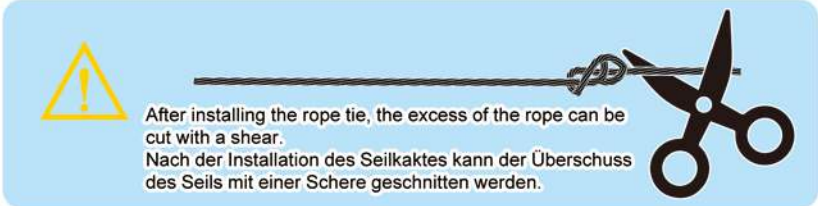

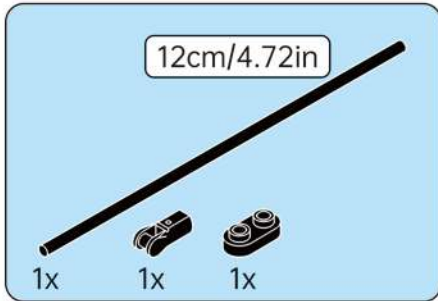

**295**

The length of the hose must be cut to the required length!  
Die Länge des Schlauchs muss auf die erforderliche Länge geschnitten werden!

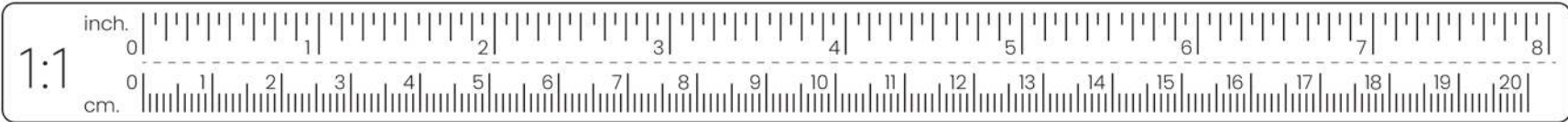
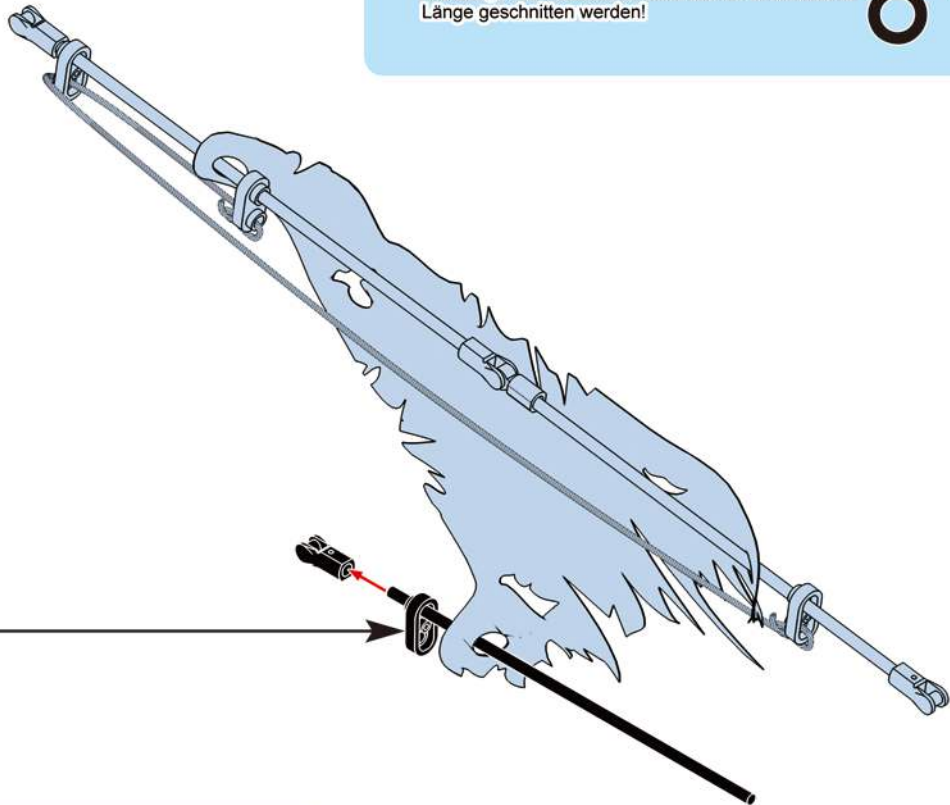
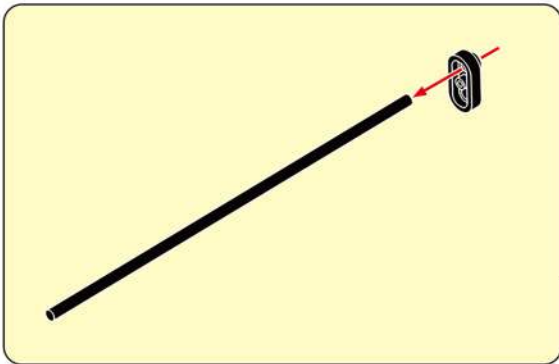

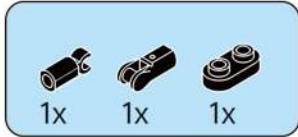

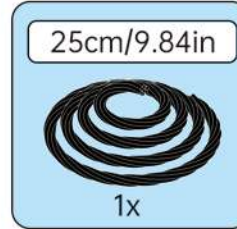
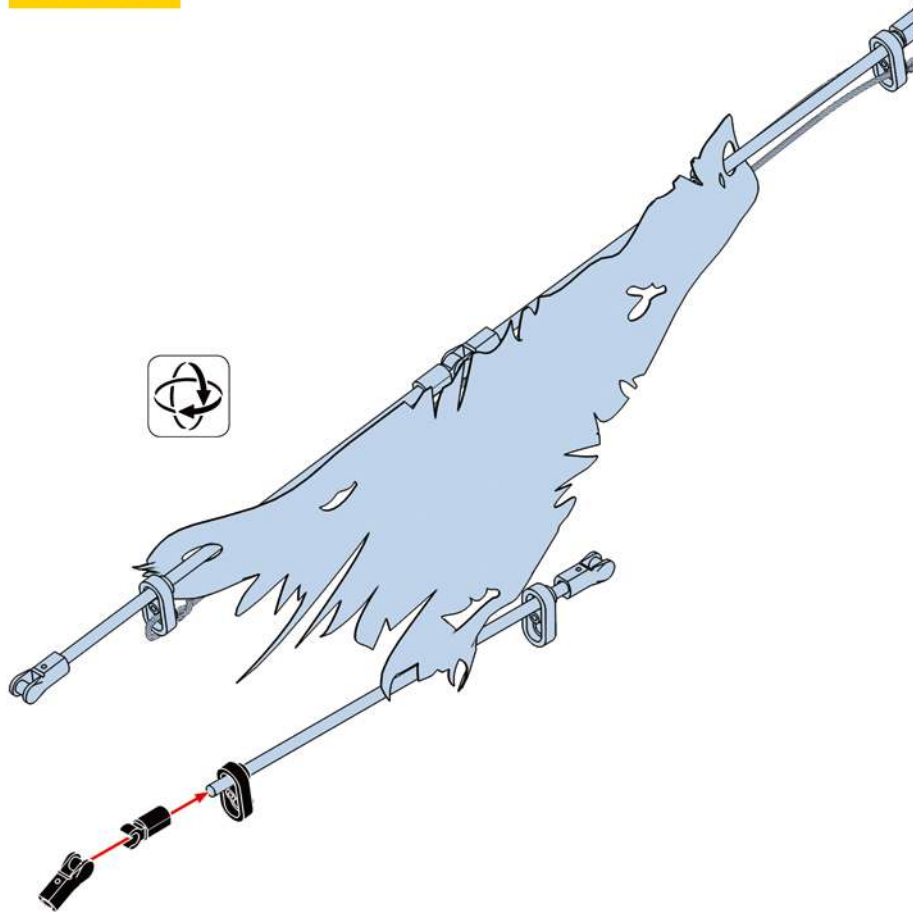

**296**

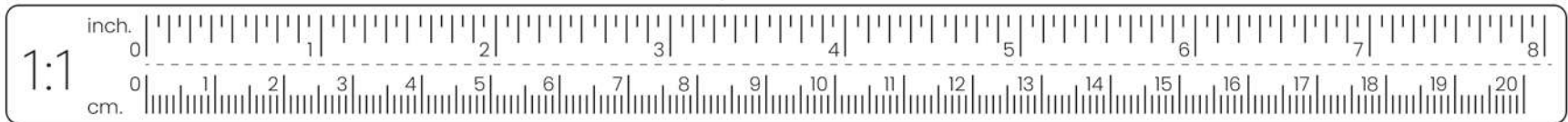
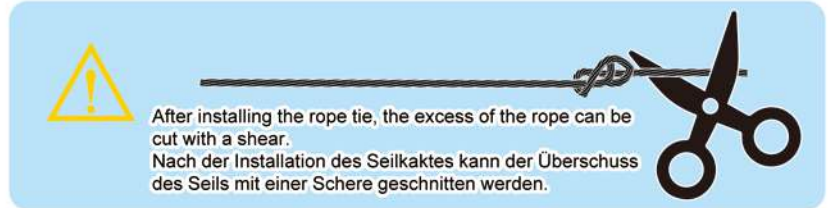
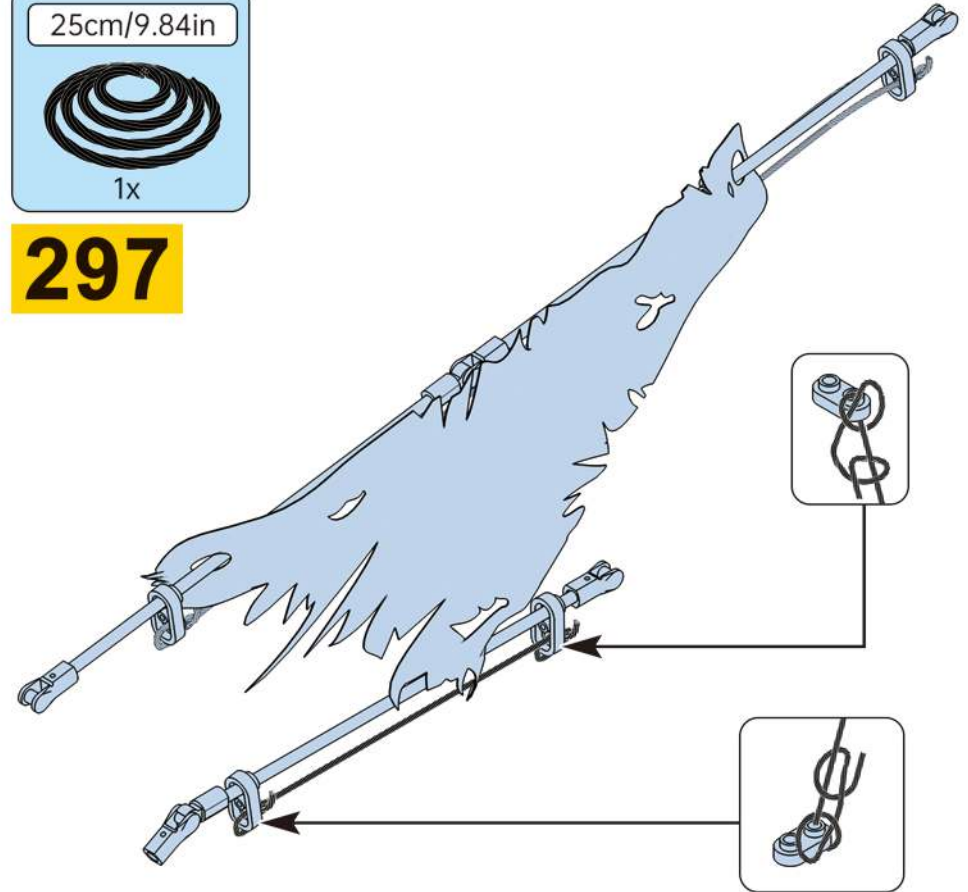

**297**



298



290

297

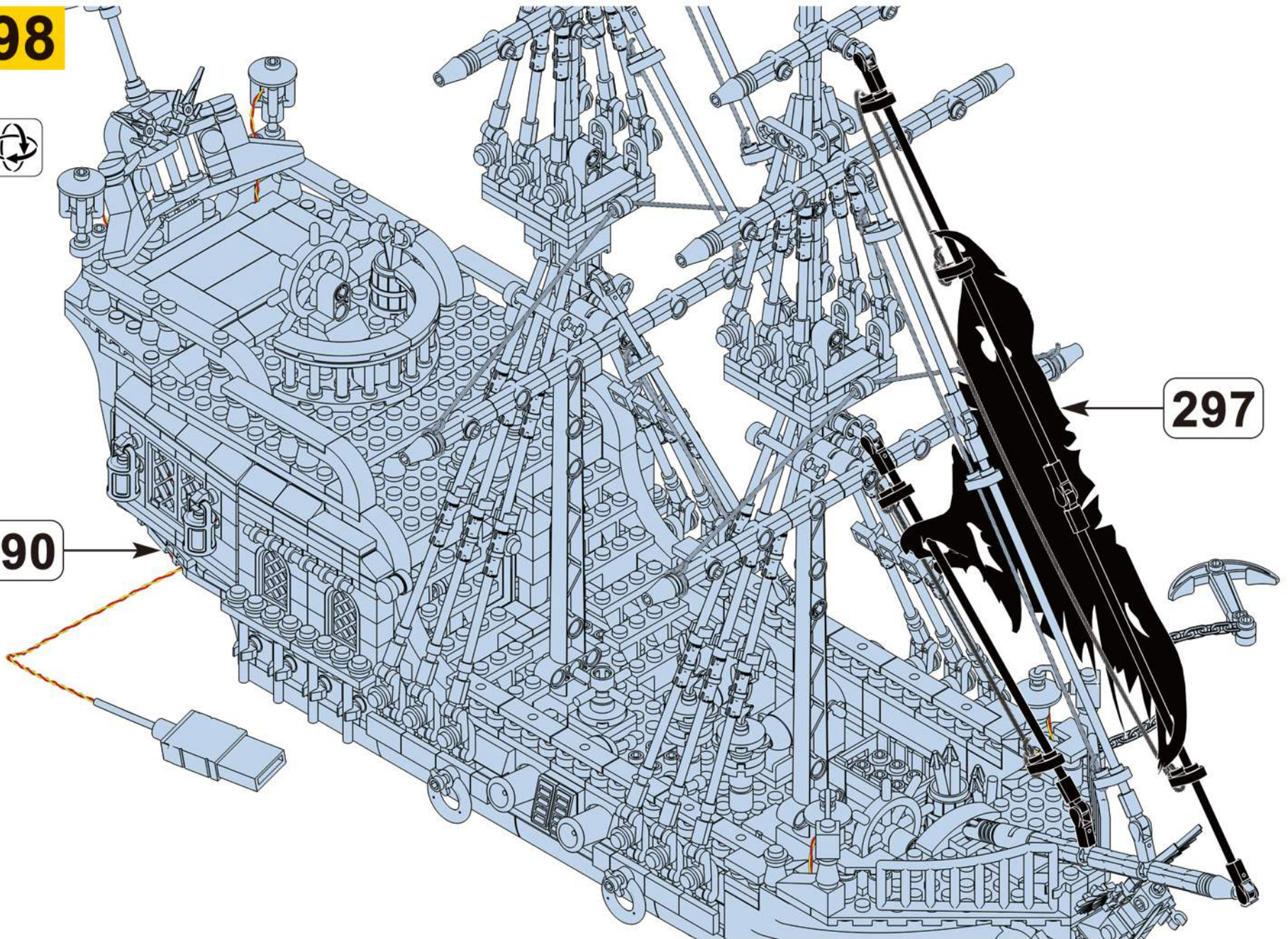

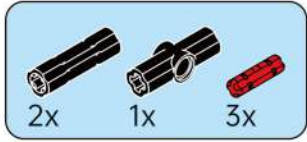

299

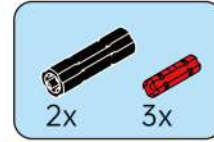
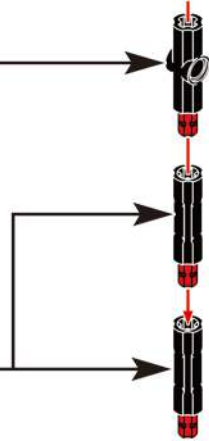
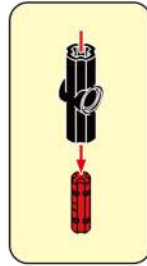
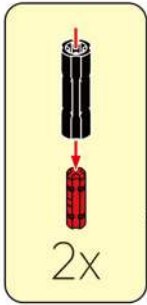

300

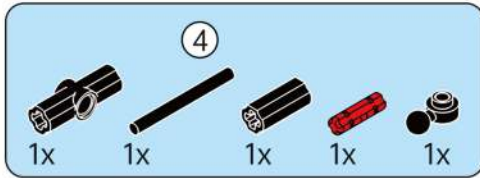
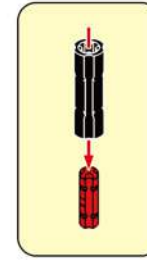
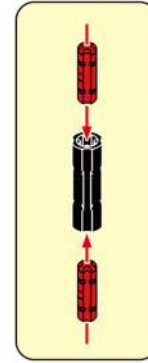

301

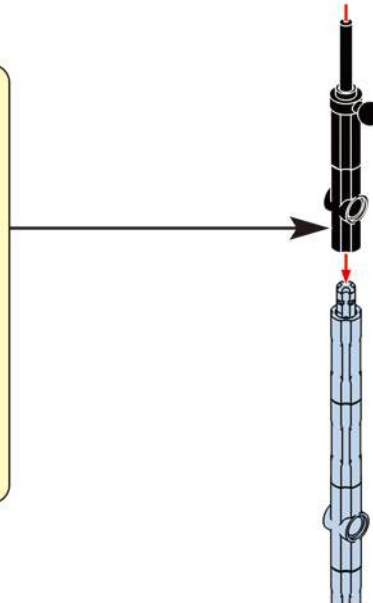
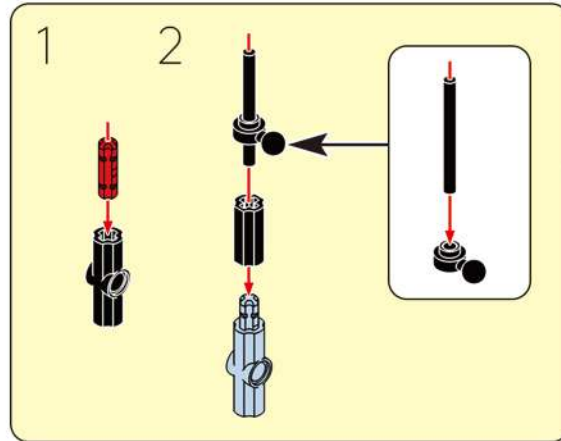

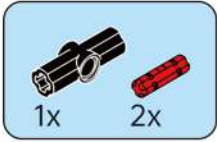

**302**

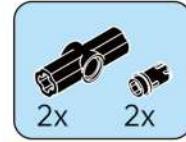

**303**

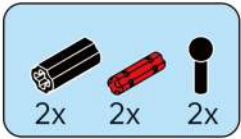
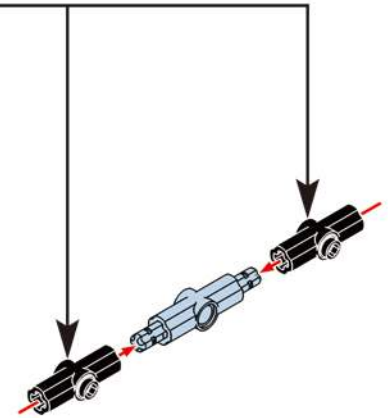
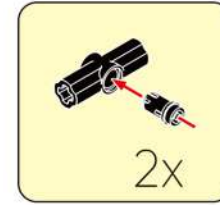

**304**

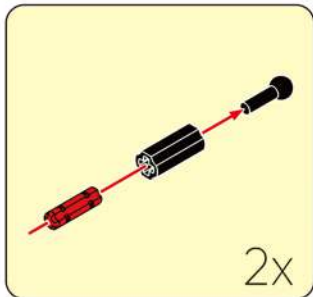
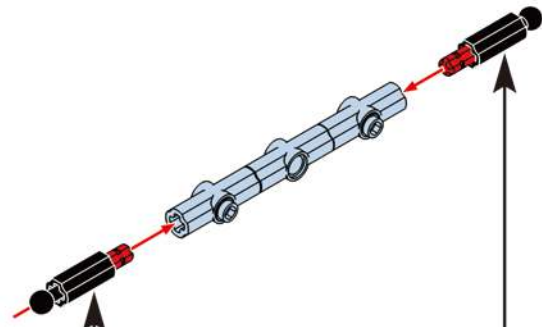

**305**

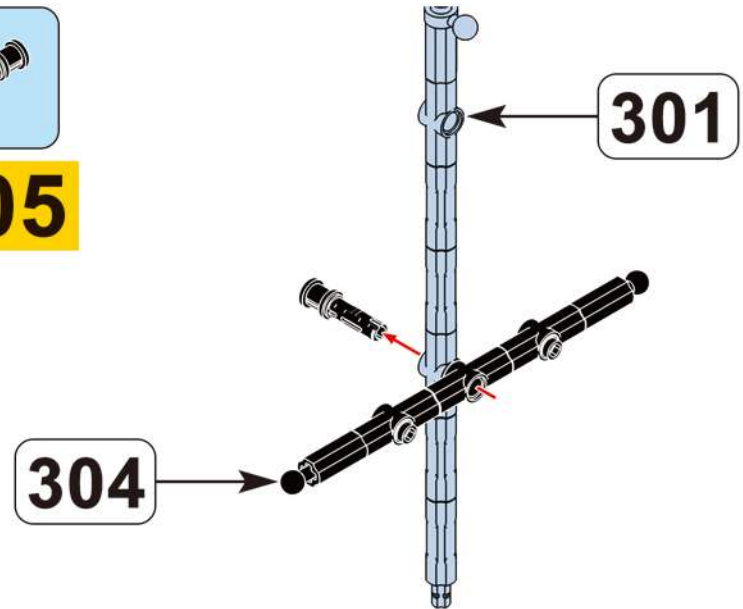

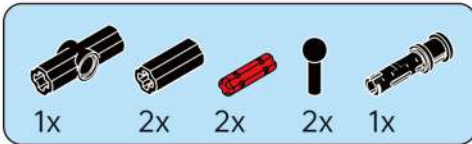

# 306

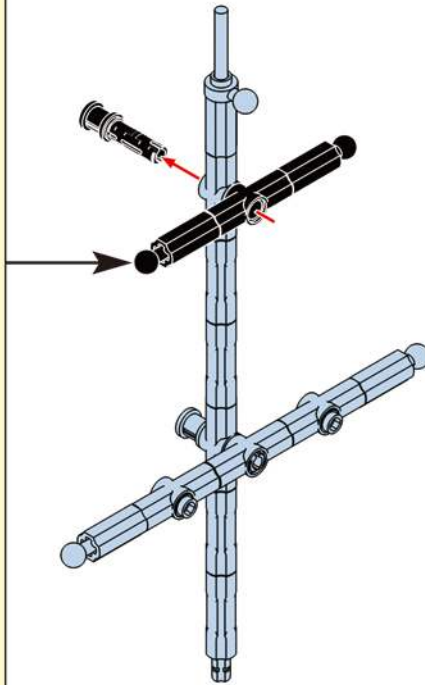
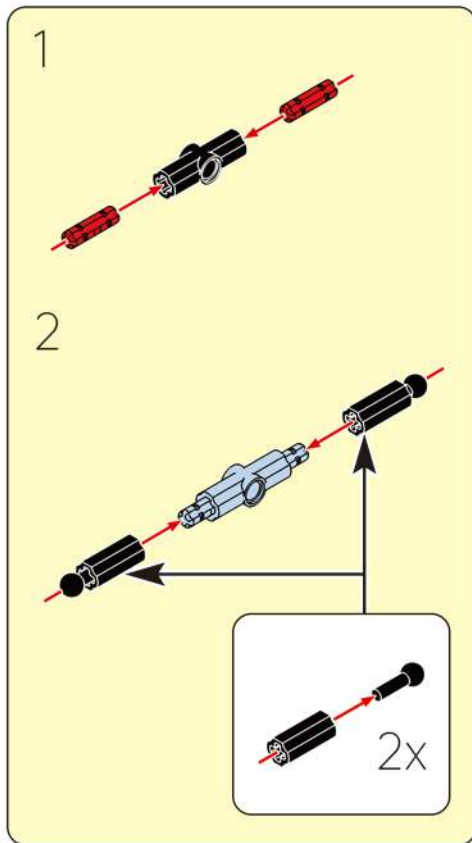

# 307

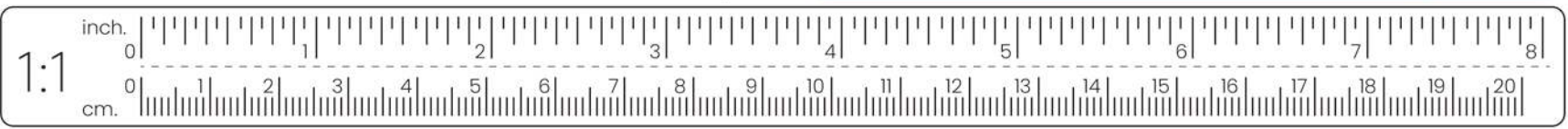
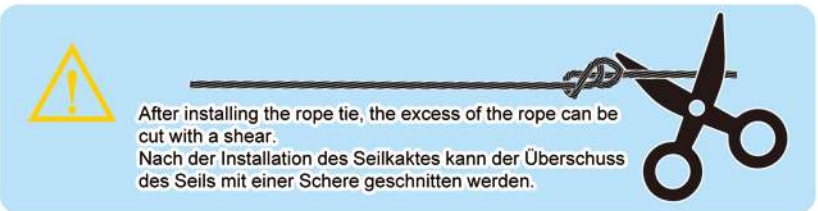
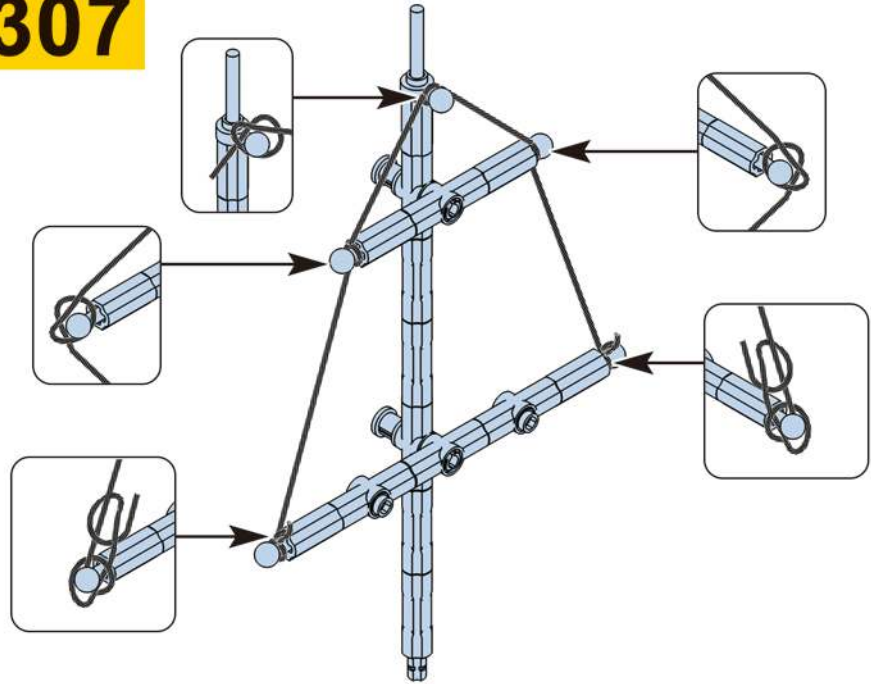



**308**

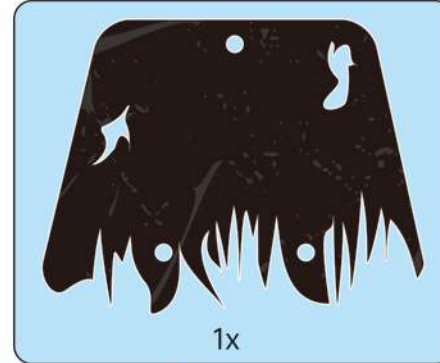
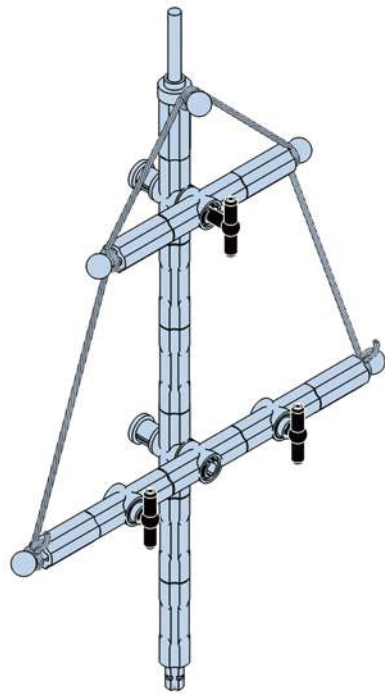

**309**

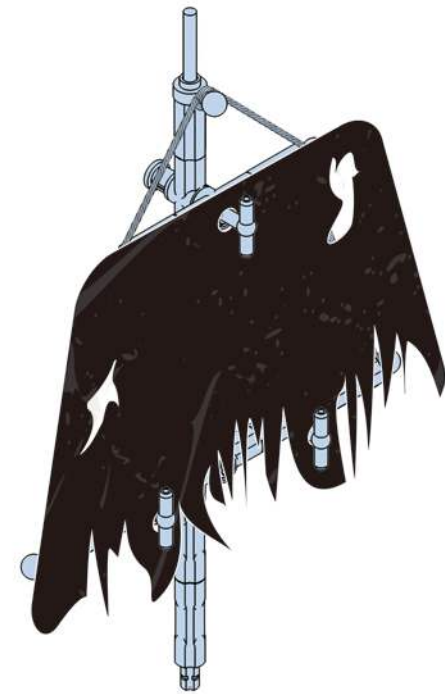

**310**

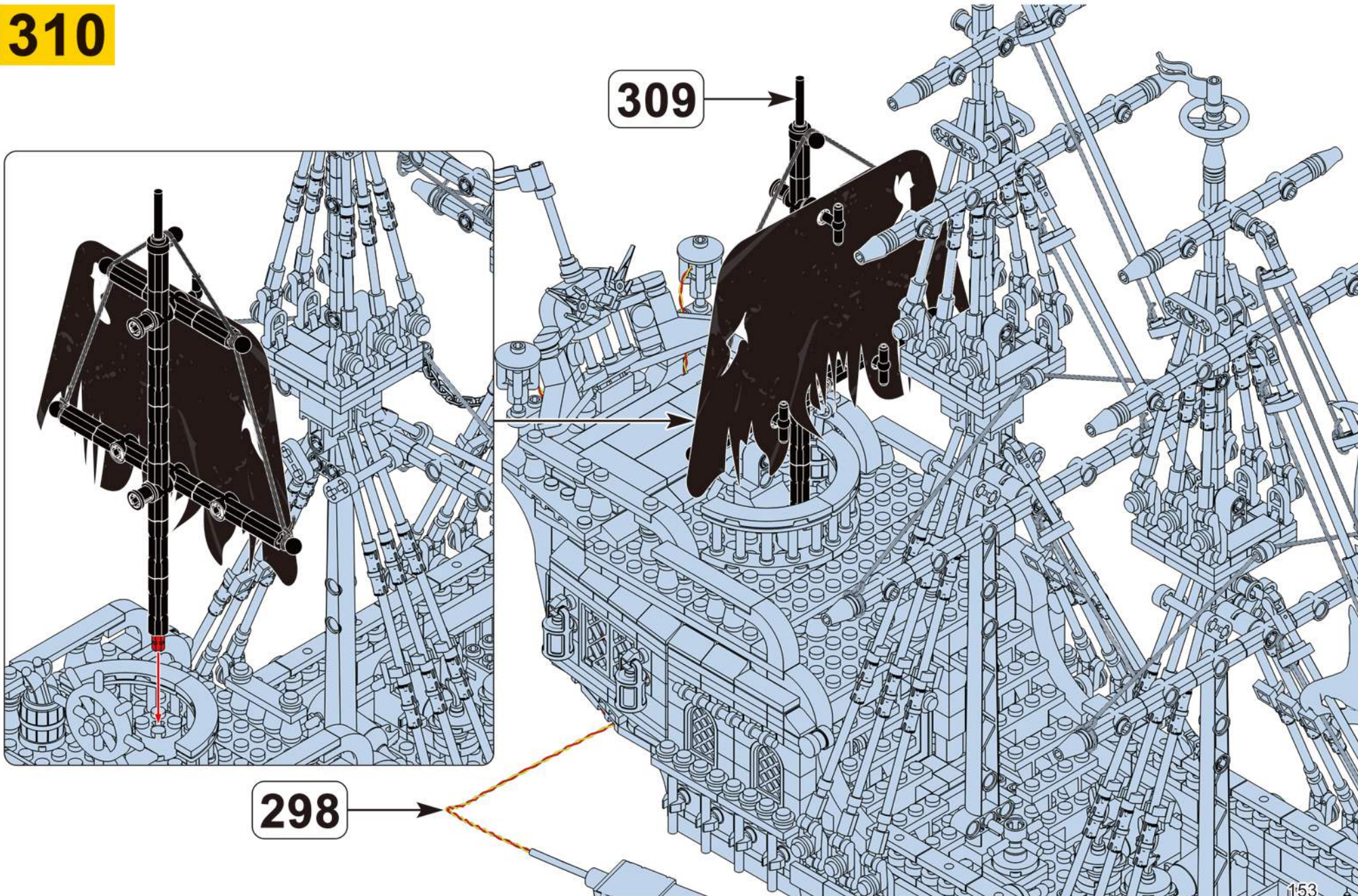



46cm/18.11in

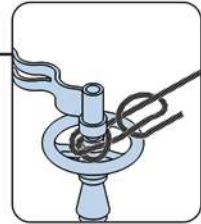
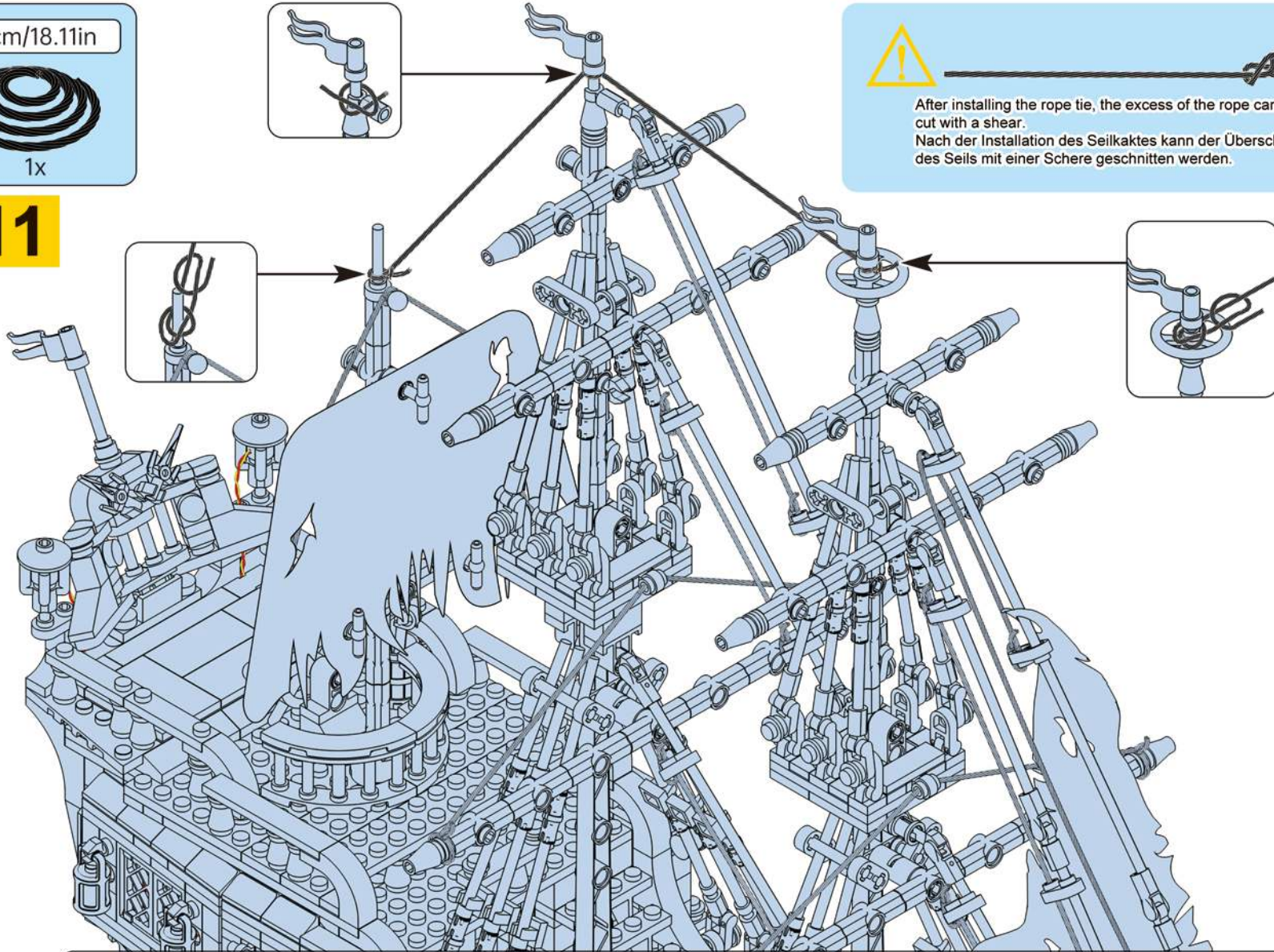

1x

**311**





After installing the rope tie, the excess of the rope can be cut with a shear.  
Nach der Installation des Seilkaktes kann der Überschuss des Seils mit einer Schere geschnitten werden.



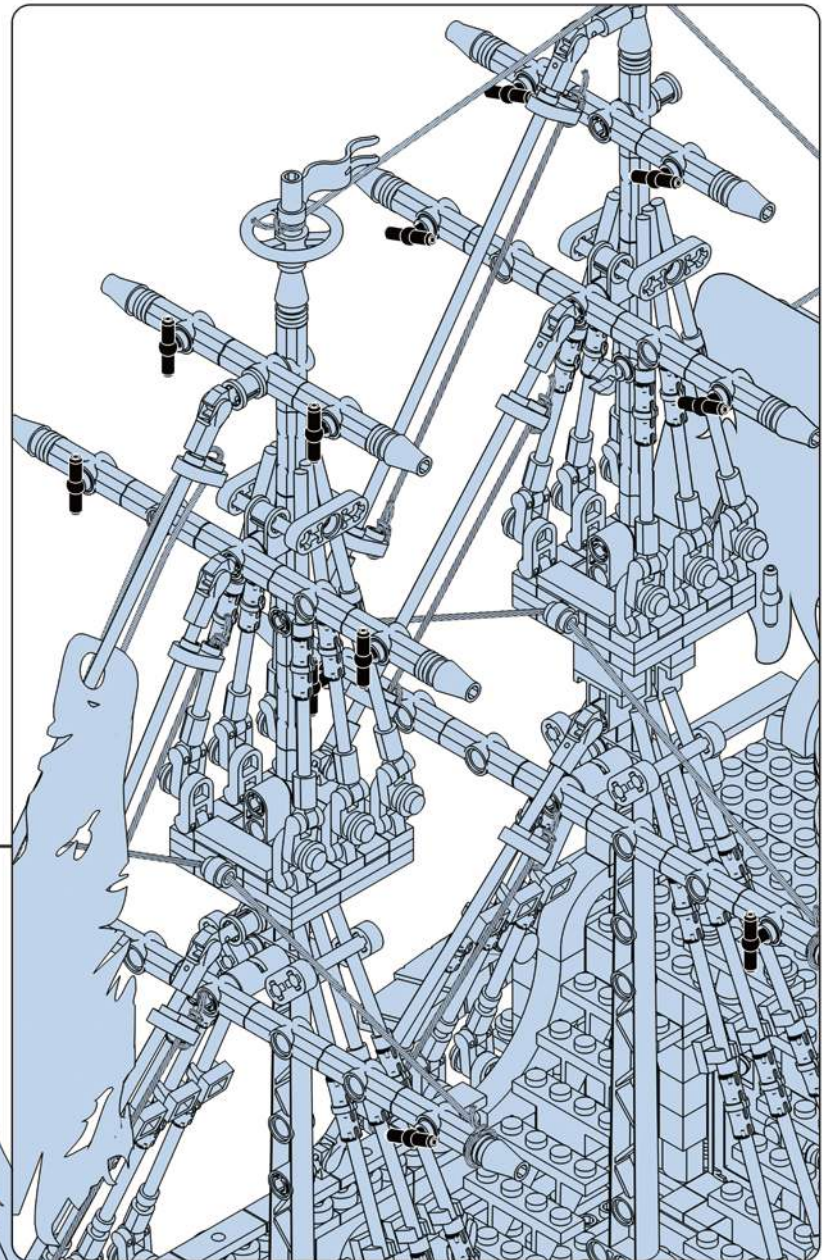
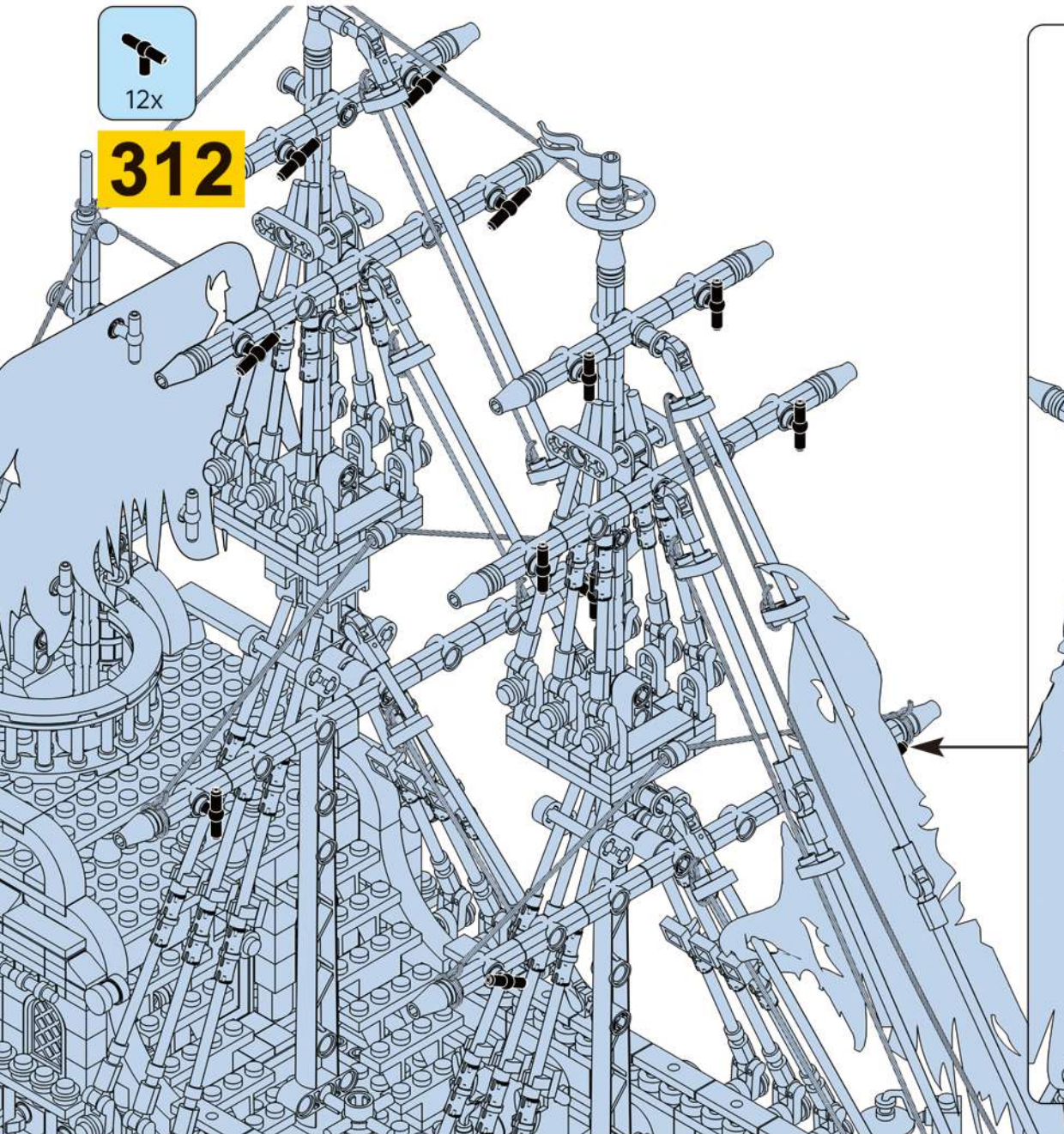

**312**



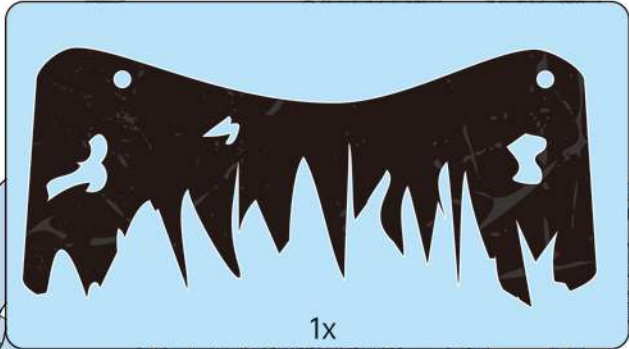

313

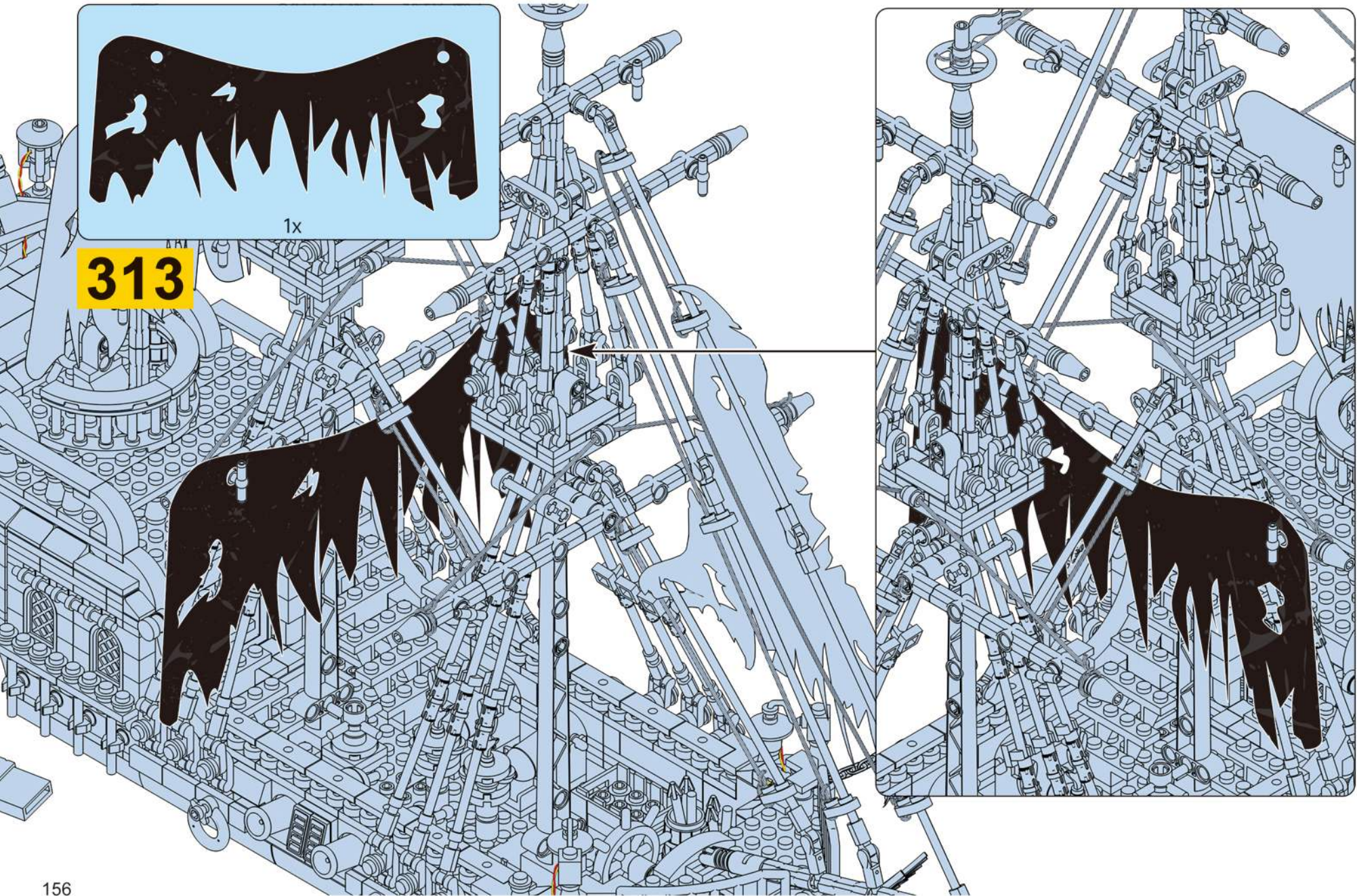

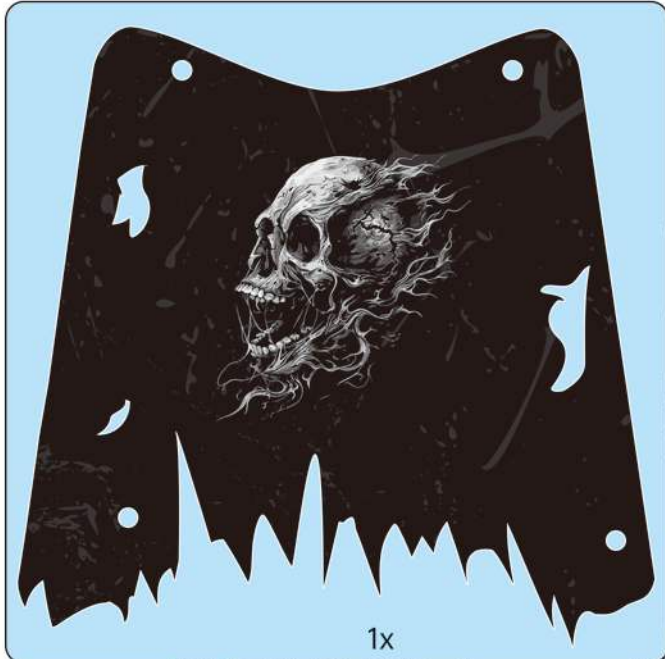

314

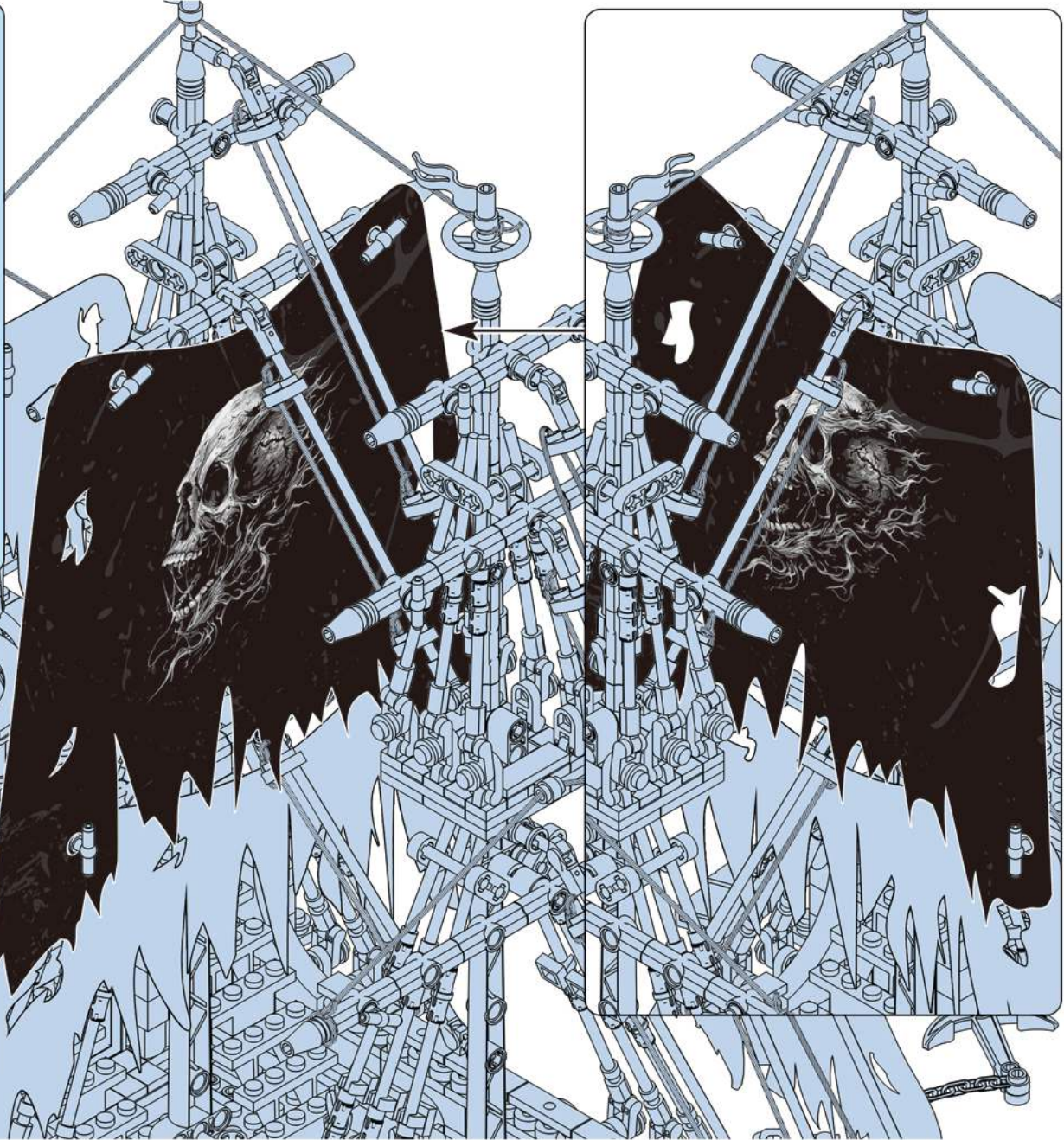

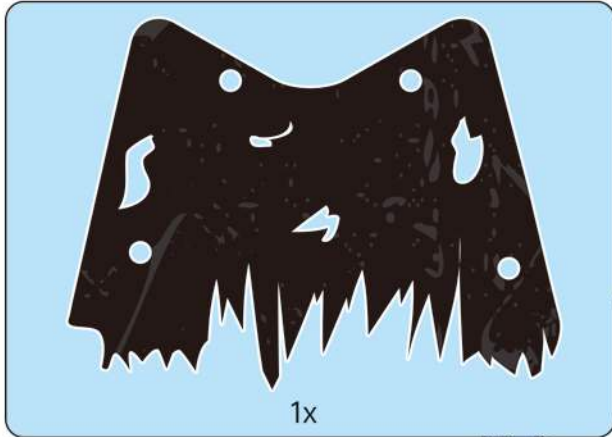

**315**

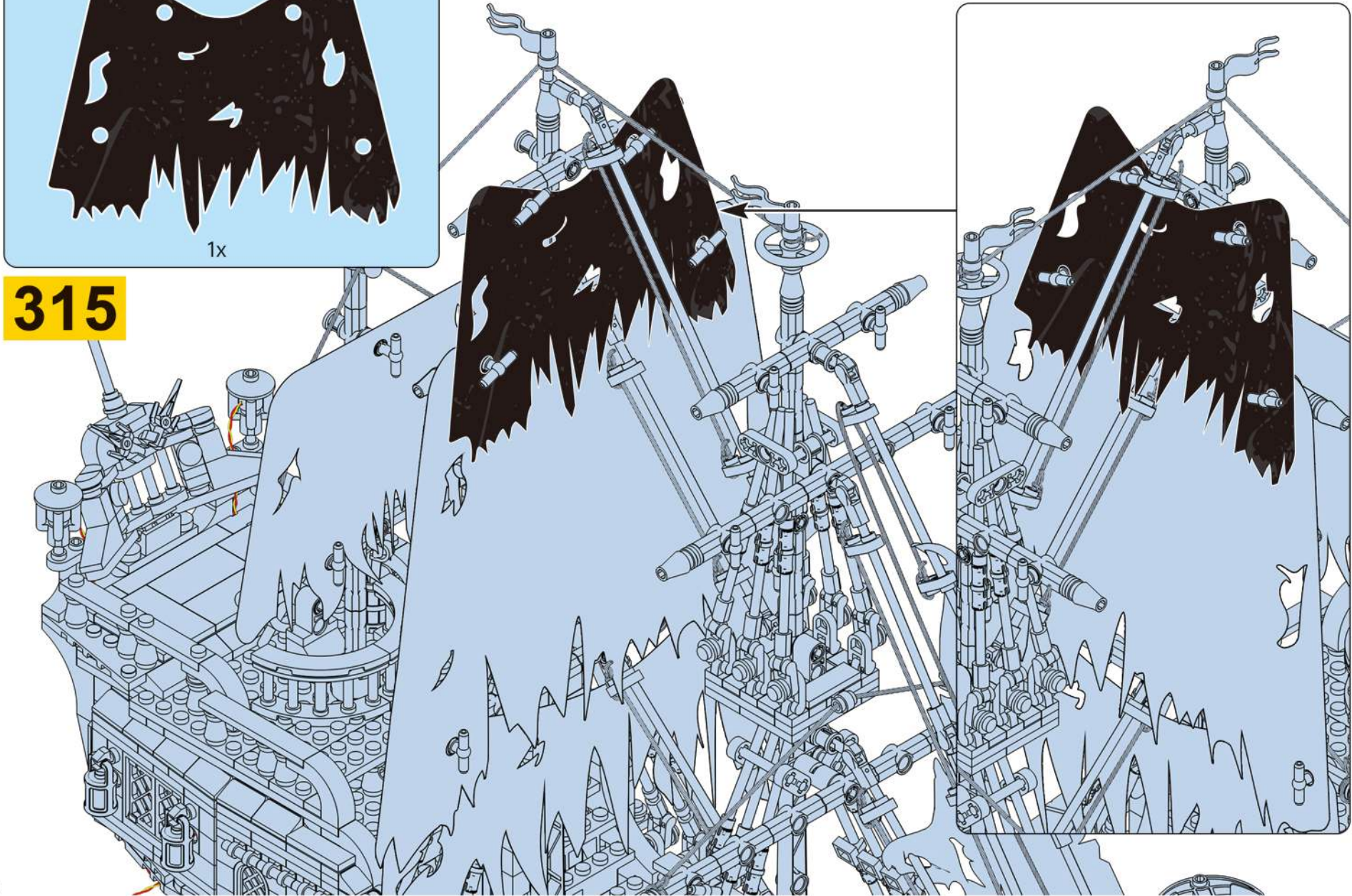

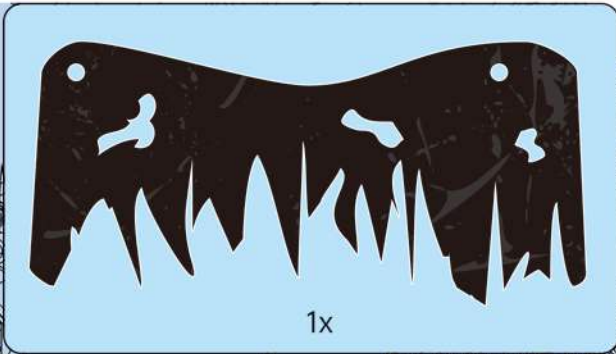

**316**

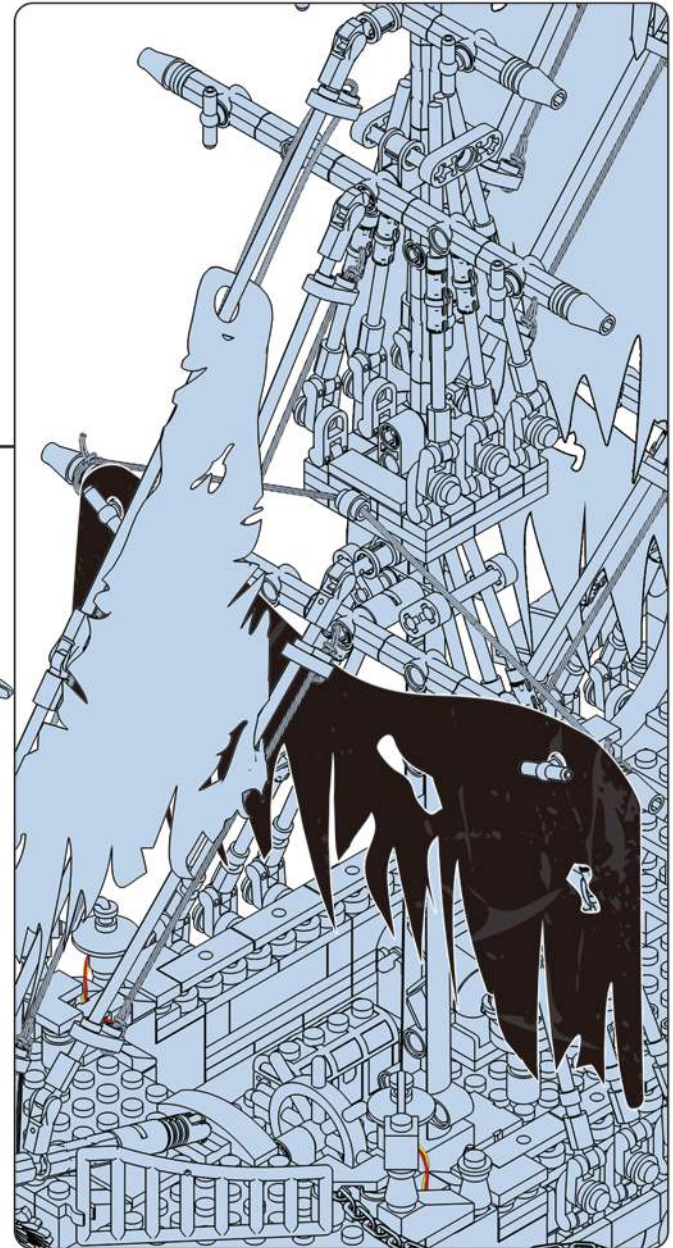
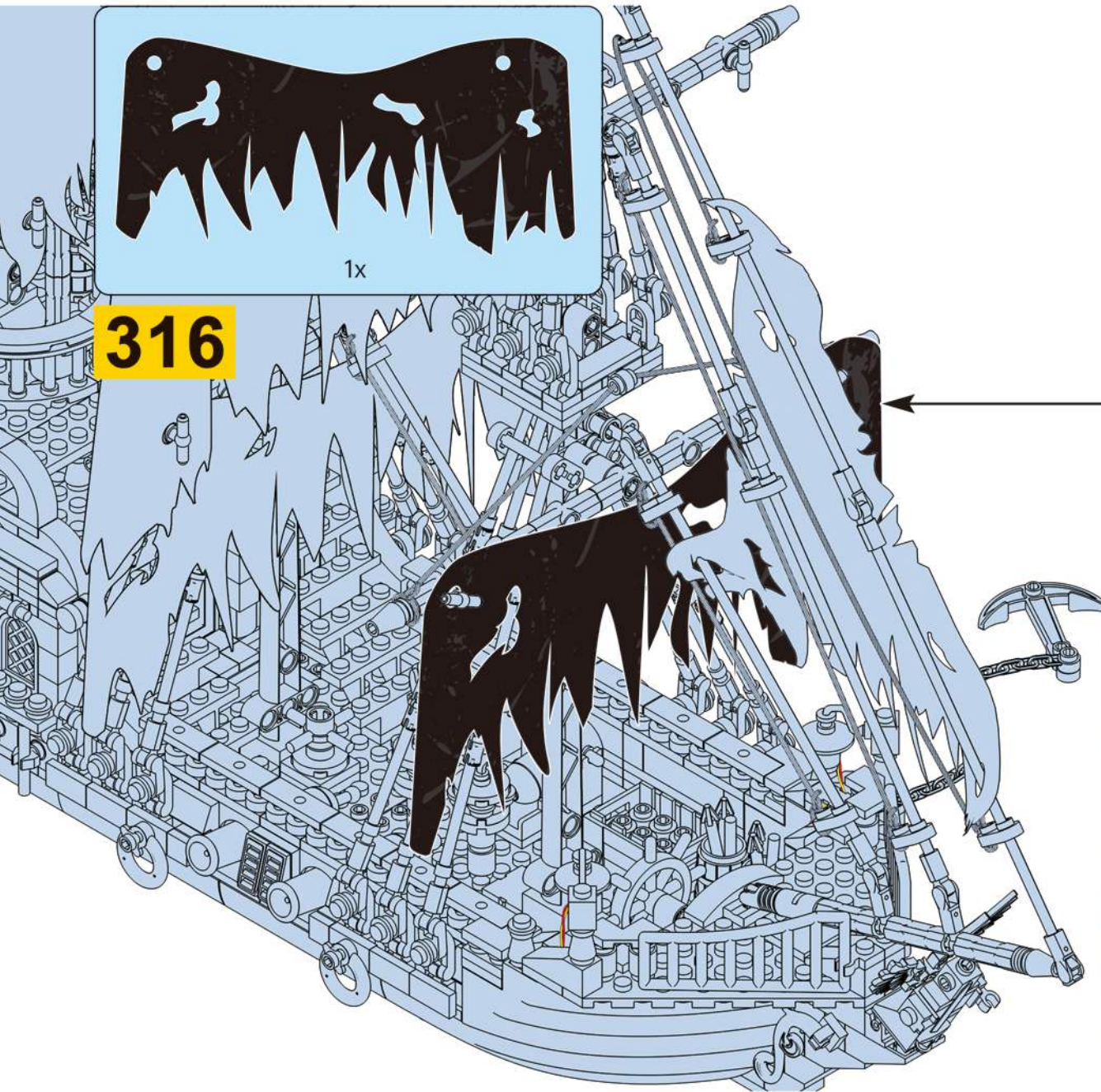



317

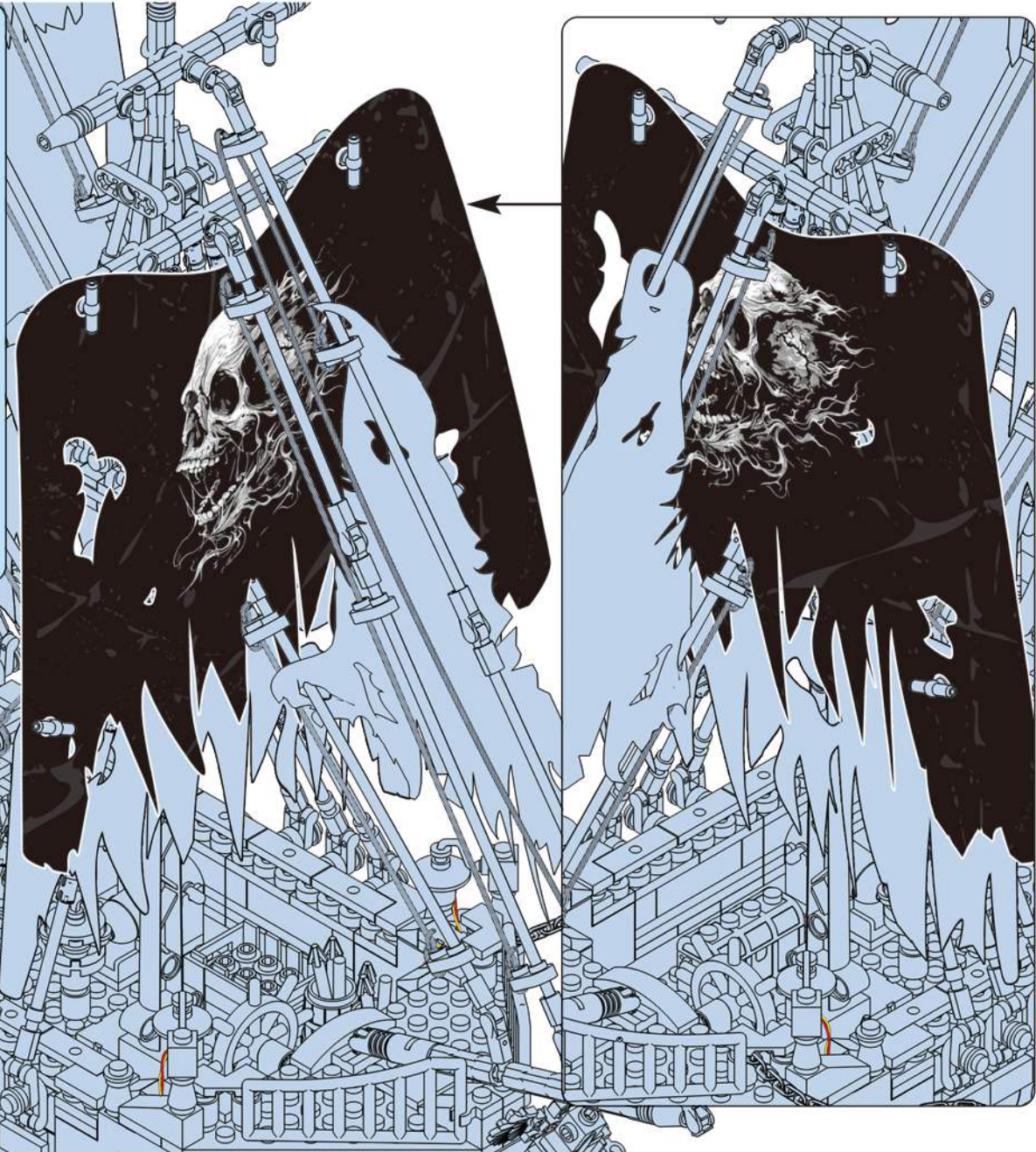

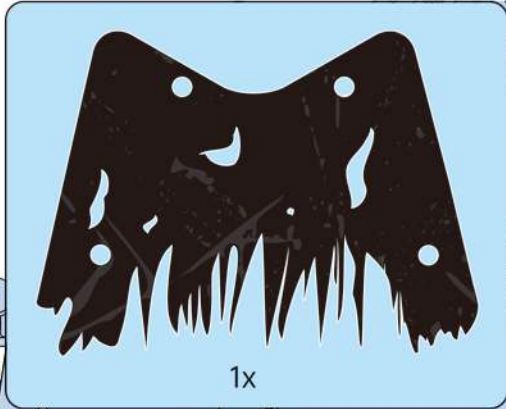

318

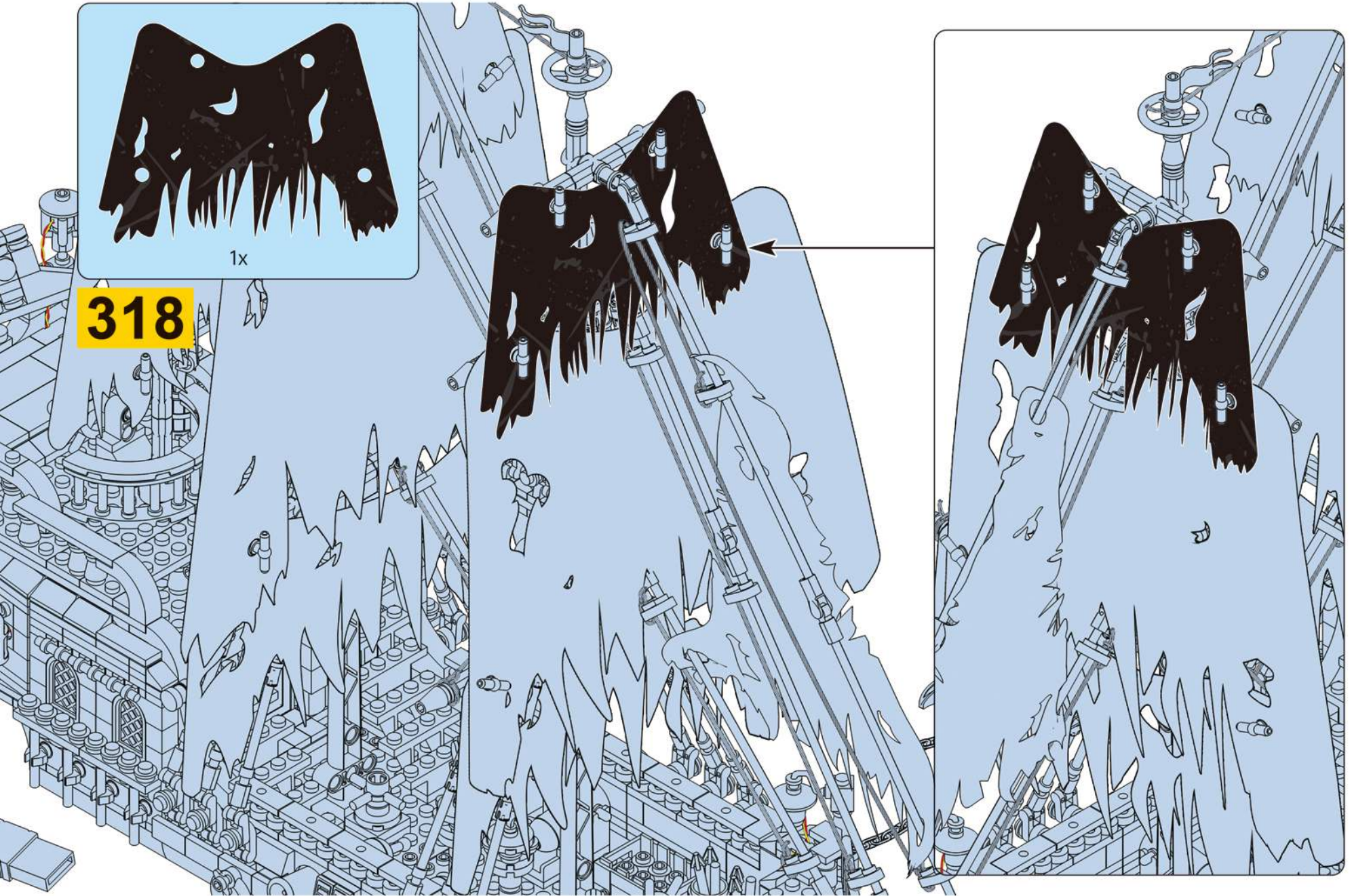

Lighting function display



# JOY MAKES BRILLIANCE.

14+  
AGES

## Embrace Relaxation Embrace Joy

Every adultescent needs a "JOY BOX".  
Please, open your JOY BOX! Heading for joy.



Thank you for choosing our JMB product.  
We would like to hear your thoughts on the new product you  
have just purchased. Your feedback will help shape the future  
development of this product line.  
You can contact us at <http://www.jmbricklayer.com> or via  
email at [Service@jmbricklayer.com](mailto:Service@jmbricklayer.com).

Vielen Dank, dass Sie unser JMB Produkt ausgewählt haben.  
Wir möchten Ihre Meinung zum gerade erworbenen neuen  
Produkt hören. Ihr Feedback wird dazu beitragen, die zukünftige  
Entwicklung dieser Produktsreihe zu gestalten.  
Kontaktieren Sie uns über [www.jmbricklayer.com](http://www.jmbricklayer.com) oder per  
E-Mail an [Service@jmbricklayer.com](mailto:Service@jmbricklayer.com).



# BRICK IT HAPPEN



**10002**  
Butterfly Effect - Mystic Flutter



**50001**  
Vintage Car Model A Deluxe Coupe



**20039**  
Vintage 3 in 1 Set



**70013**  
Mantis Shrimp



**70008**  
Rainbow Unicorn



**70010**  
Swimming Jellyfish



**70011**  
Mechanical Hummingbird



**70016**  
Impression Sunrise



**70017**  
Phoenix Nirvana



**70015**  
Woodland Pegasus



Dear valued customer,  
We sincerely hope you enjoy the product and we can't wait to see you again soon. Please let us know if we can do anything else to help! If you are pleased with your purchase and plan to buy from us again, we have a special offer just for you. When making your payment, please utilize the exclusive discount code "JMBVIP28A6" to avail yourself of a generous 20% discount.

**14+**  
**AGES**

Long-term Effective

**20% OFF**  
Discount Code  
**JMBVIP28A6**

Available on [www.jmbricklayer.com](http://www.jmbricklayer.com)  
Online store Support: [Support@jmbricklayer.com](mailto:Support@jmbricklayer.com)

# BRICK IT HAPPEN

---



**60014**  
Strategic Nuclear Submarine



**40003**  
Queen Anne's Revenge



**60015**  
Bismarck Class Battleship



**70019**  
Mythic Dragon Tiles



**70020**  
Mythic Dragon Tiles

---



**JMBricklayer**

---

## Embrace Relaxation Embrace Joy

---

Every adultescent needs a "JOY BOX".  
Please, open your JOY BOX ! Heading for joy.

