



JM2 Bricklayer

Rainbow Unicorn

Brick It Happen

| 70008 | 1492+Pcs



WARNING: CHOKING HAZARD
Toy contains small parts and a small ball.
Not for children under 3 years.

14+
AGES



Embrace Relaxation
Embrace Joy



Every adultescent needs a "JOY BOX".
Please, open your JOY BOX!



Heading for joy.
Welcome to the Unzip Club.







Contact us can visit www.jmbricklayer.com email Service@jmbricklayer.com or via our app **JMBricklayer**

Welcome each and every one who came to discuss business cooperation via email Business@jmbricklayer.com.

You can find us on Facebook and Twitter to get latest products information and activities. Search **JMBricklayer** on Facebook and Twitter.

If you find something was missing or broken from your new set. We do our best to make every set perfect and we take it very seriously when a faulty one sneaks through. Don't worry though, we can send you the parts you need!

Please upload a complete description of the part along with the set number via email: Service@jmbricklayer.com or our app **JMBricklayer**

Once your part is on its way, we'll send you a shipping confirmation email.

PART ASSEMBLY ORDER



The color of the bags shown in the image is for reference only (subject to the actual product).

BRICK COMPARISON UNITS

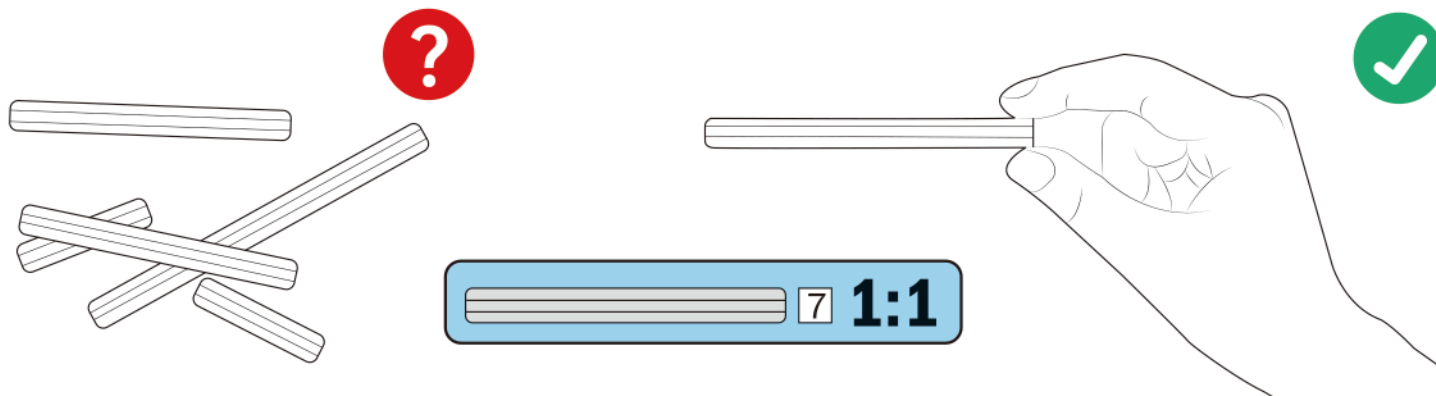

USAGE OF BRICK SEPARATOR

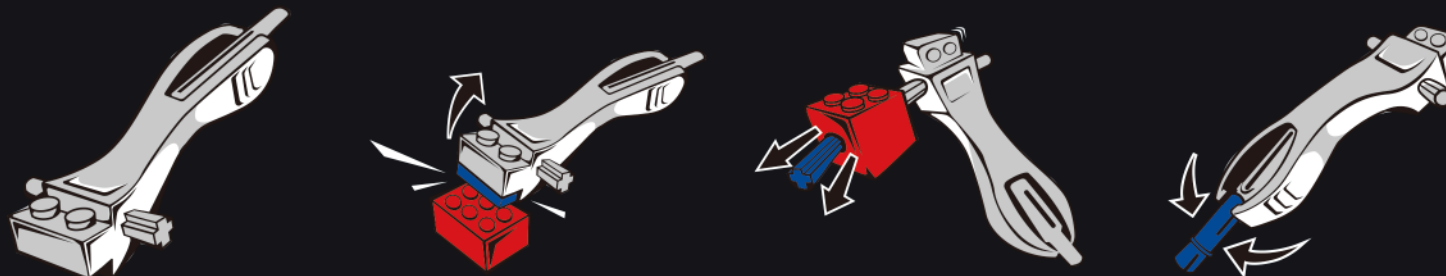

The shape and color of the accessories shown in the image are for reference only (subject to the actual product).

STICKER INSTRUCTION

01

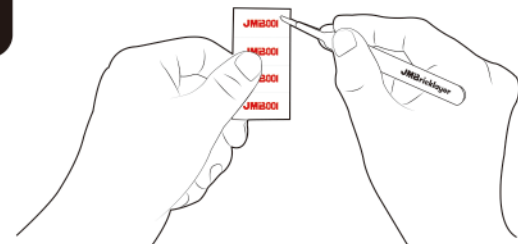

Pick up the transparent edge of the sticker with tweezers.

02

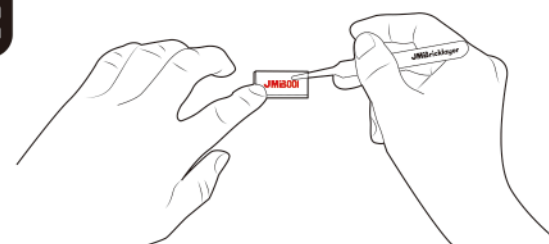

Align the position and stick it to the brick.

03

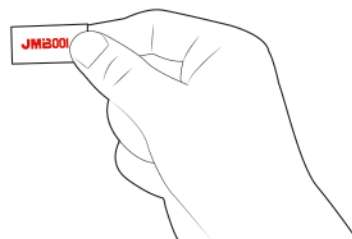

Press the sticker to make them stick tightly together.

04

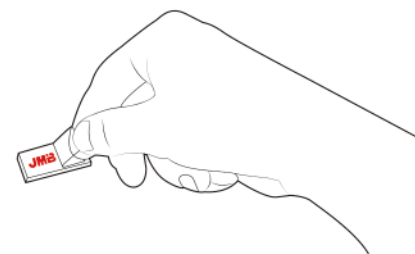

Tear off the transparent film.

Note: Some sets come with fully printed brick pieces, in these cases, there are no stickers/decals. Please refer to the actual product for details.

WHAT'S INCLUDED



JOY MAKES
BRILLIANCE.



Building Bricks



LED Light kit



Brick Separator



User Manual

LED LIGHT KIT PACKAGE LIST

Please check carefully and ensure all the lighting accessories are inside the package. Please contact us if there is any missing components.

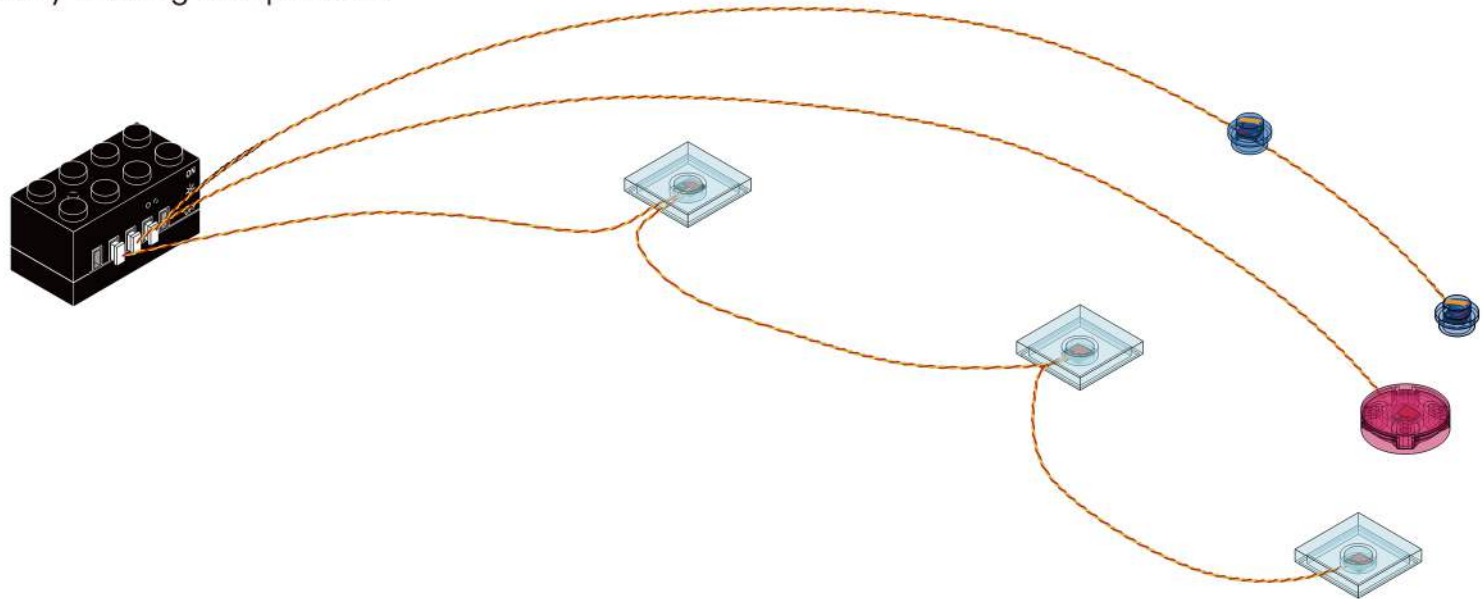

Note: Please take out and install your led lights carefully, no hard pulling, no bending or shaking, otherwise it might damage the lights.

USER INSTRUCTION



JOY MAKES
BRILLIANCE.

Please read the following carefully before installing the lights.

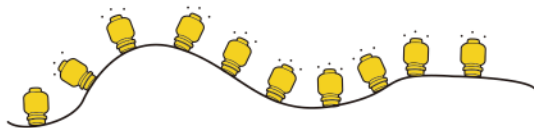

Before installing, please connect to the power supply and test the lights to make sure everything functions properly. If the lights do not work, please refer to the TROUBLESHOOTING or contact us.

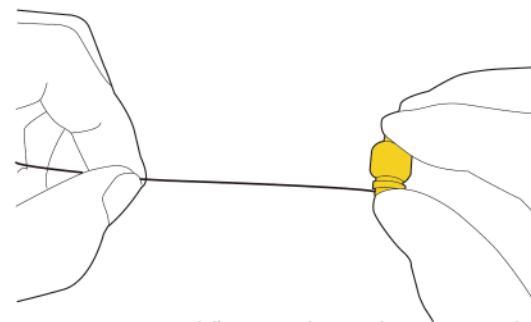

LED components are delicate, so please take extra care when installing, no hard pulling, no bending or shaking.

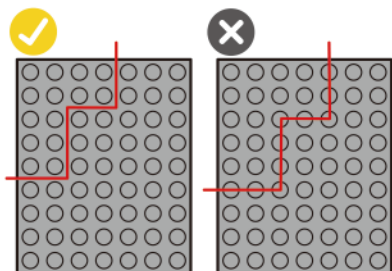

Hide the spare wire under the bricks: when installing, please make sure that the wire is laid between two studs of the bricks, but not pressed by the bricks directly.

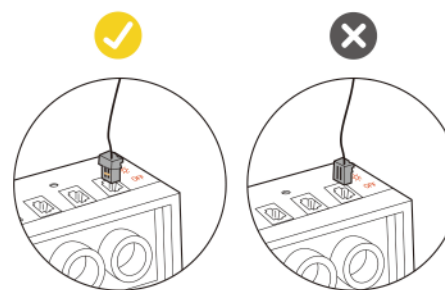

Connectors can be plugged into ports of the expansion board in only one certain way. Make sure its direction is correct before plugging.

Tips: if the connector doesn't fit easily into a port, don't force it.

USER INSTRUCTION



JOY MAKES
BRILLIANCE.

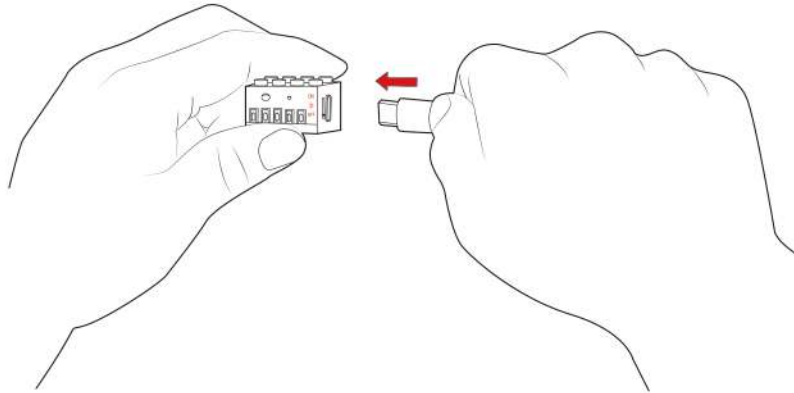

When connecting to power, the input voltage must be less than 5V, otherwise, it may damage the components of the battery brick.

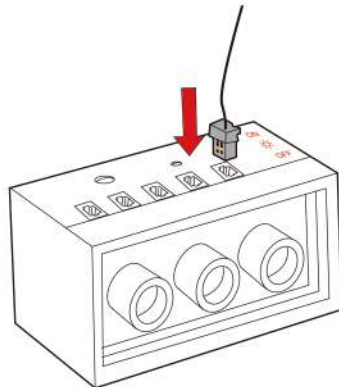

Connectors can be plugged into ports on the battery brick in only one certain way. Make sure its direction is correct before plugging. Tips: if the connector doesn't fit easily into a port, don't force it.

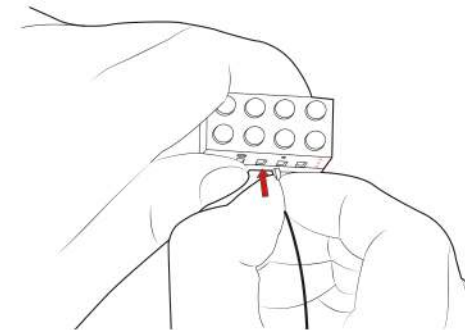

When plugging and unplugging the wire connectors, gently pull on the white connector with your fingers. Be sure not to pull the light wire with force, as this could break the wire.

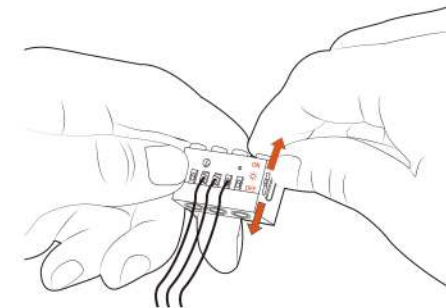

These three modes meet versatile usage scenarios, catering to different needs, whether constant illumination, energy-saving automation, or complete shutdown.

Note: When in use, the voltage must be less than 5V. Not for children under eight.

LIGHTING FUNCTION DISPLAY

ON

In this mode, the lights remain continuously illuminated once turned on, providing steady illumination until manually switched off.



This mode activates the light only when ambient lighting is low, automatically turning on during nighttime or in dark conditions and switching off in bright environments, effectively saving power.

OFF

Selecting this mode completely turns off the device, ensuring no power consumption occurs until the user manually activates it.

TROUBLESHOOTING



JOY MAKES
BRILLIANCE.

Due to their small size, lighting accessories are susceptible to damage during installation. Common causes of failure include:

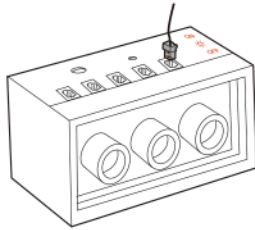

Ensure that the connectors are correctly installed as shown in the picture.



Check if the wires are disconnected or broken from the solder joints.

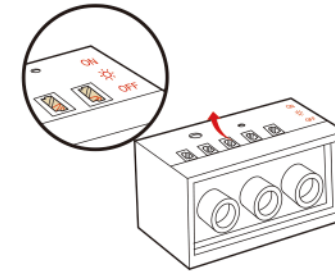

Check the internal pins of the ports on the battery brick. The internal pins of a properly working port should be straight, if the small pins are bent, they may be considered faulty ports.

SAFETY PRECAUTIONS

- 1 Before use, please make sure to check the voltage to avoid damage to the product and potential safety hazards.
- 2 The lights in the product are not replaceable. If they are damaged or not lighting up, please refer to the troubleshooting section or contact our customer service for assistance.
- 3 Avoid pulling on the lighting wires as this may cause damage.
- 4 Do not expose the product to water as it may damage the product.
- 5 If the plug does not fit easily into the ports on the board, reverse the direction and insert it again to avoid damage and short circuits, rather than forcing it in.
- 6 Please read and follow the instructions carefully during building to ensure a good building experience.

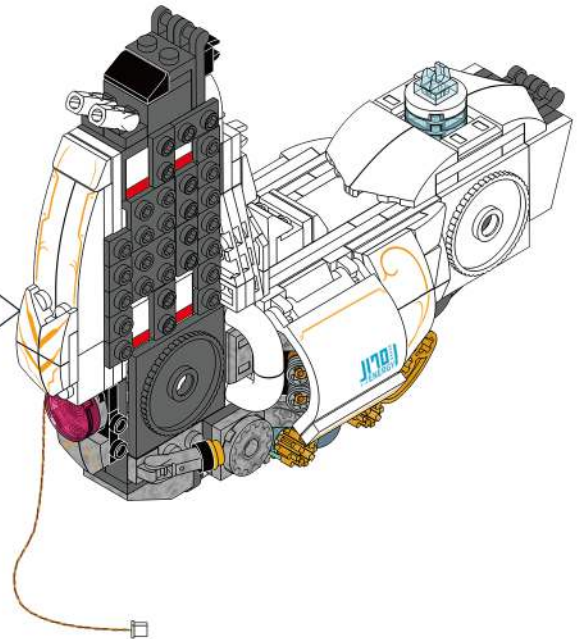
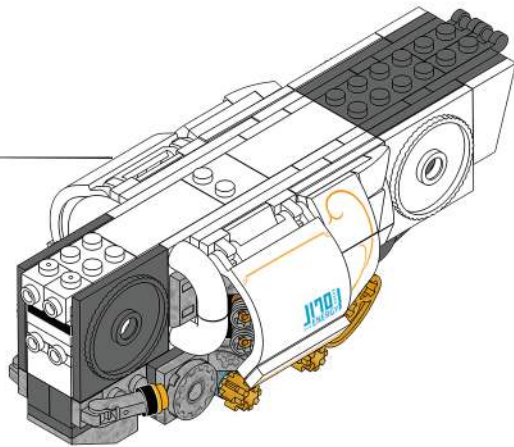
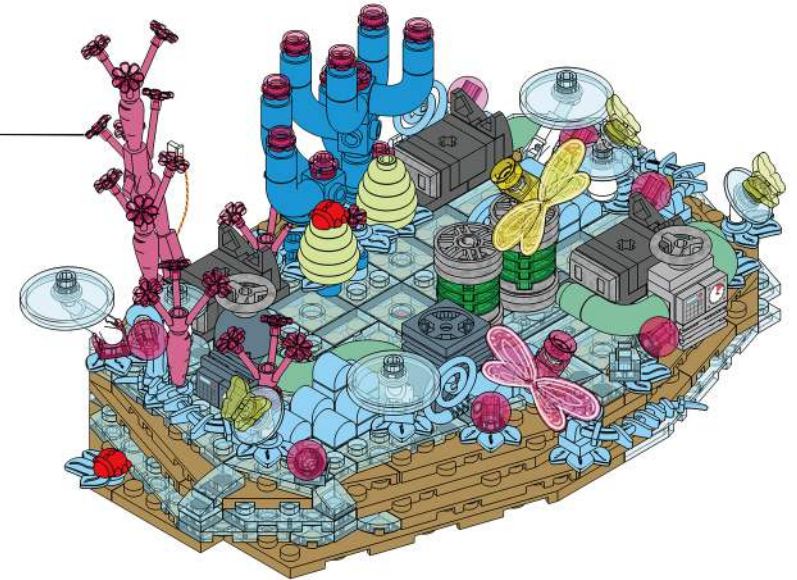
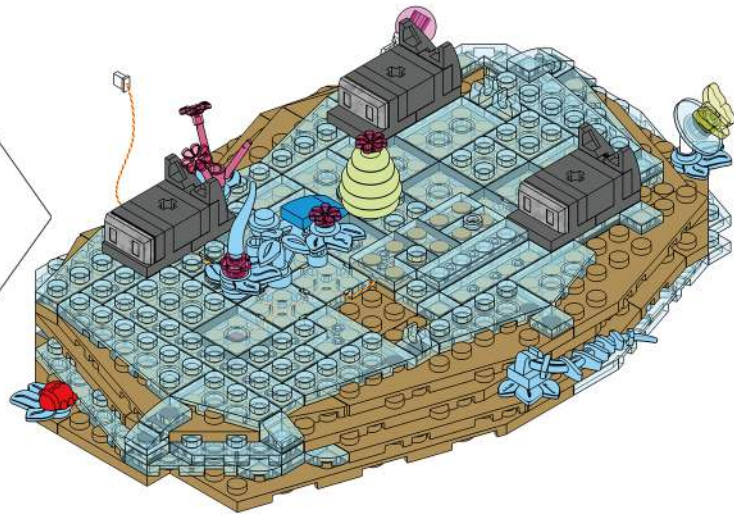

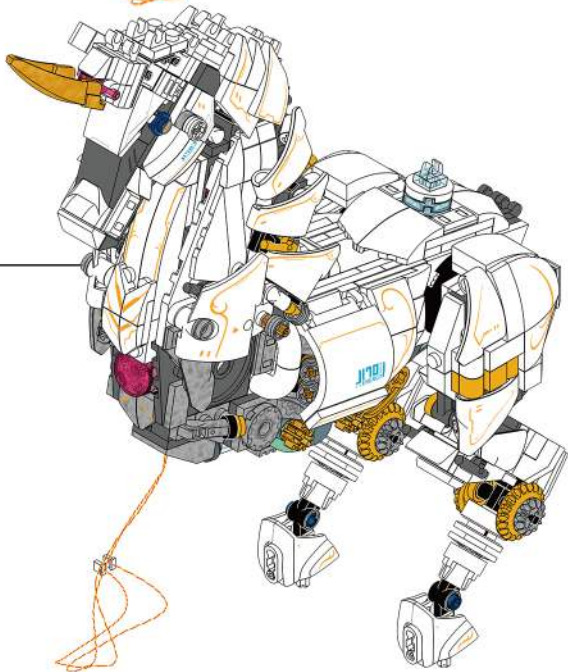
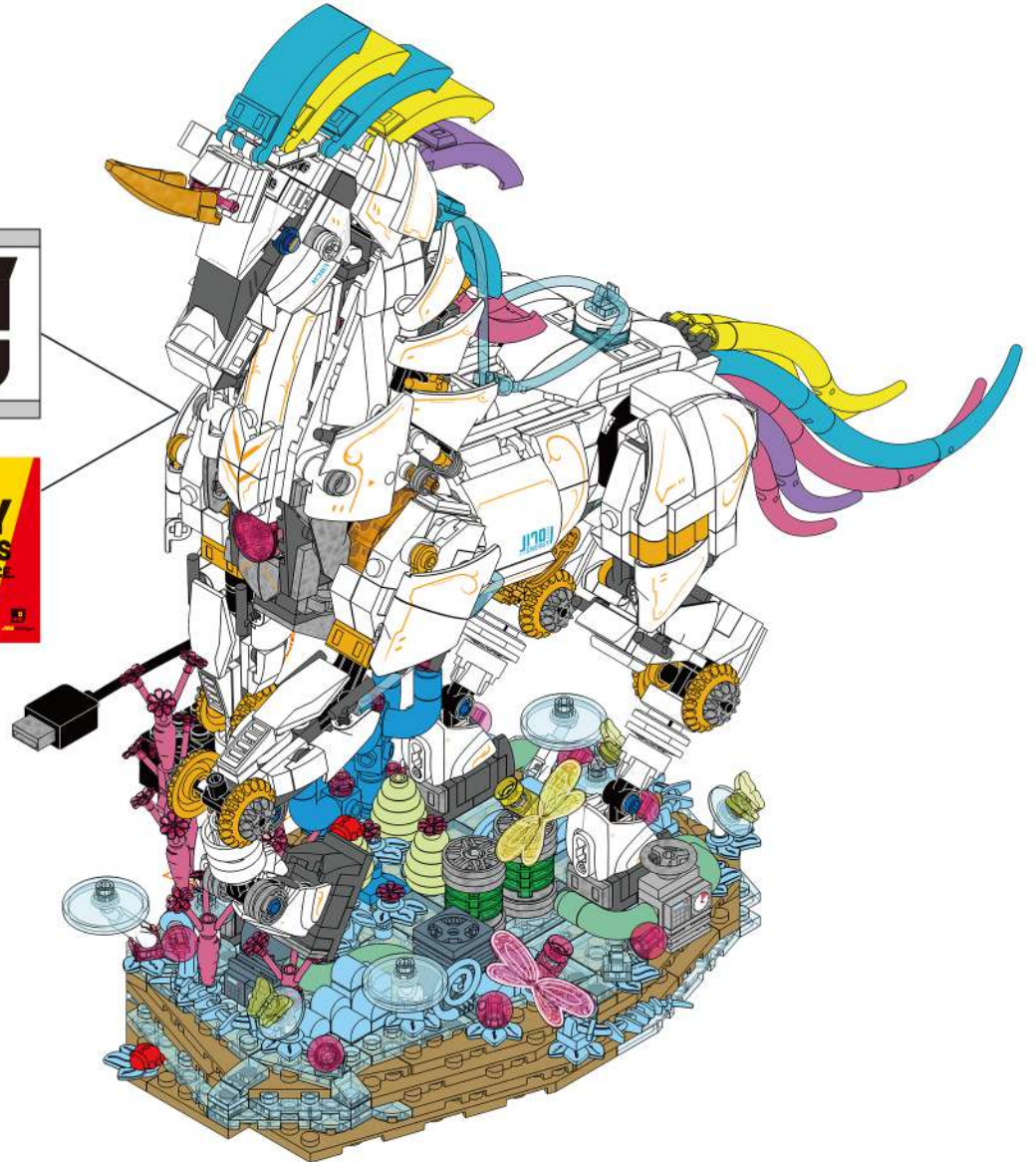
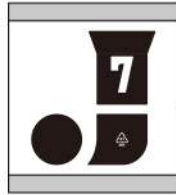
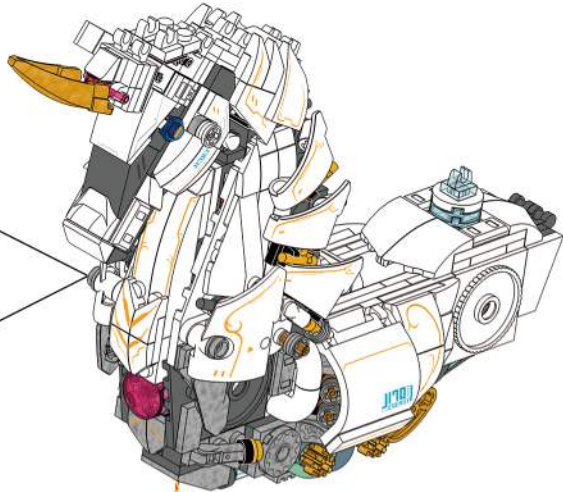

JOY MAKES BRILLIANCE.

Embrace Relaxation Embrace Joy

Every adultescent needs a "JOY BOX".
Please, open your JOY BOX! Heading for joy.

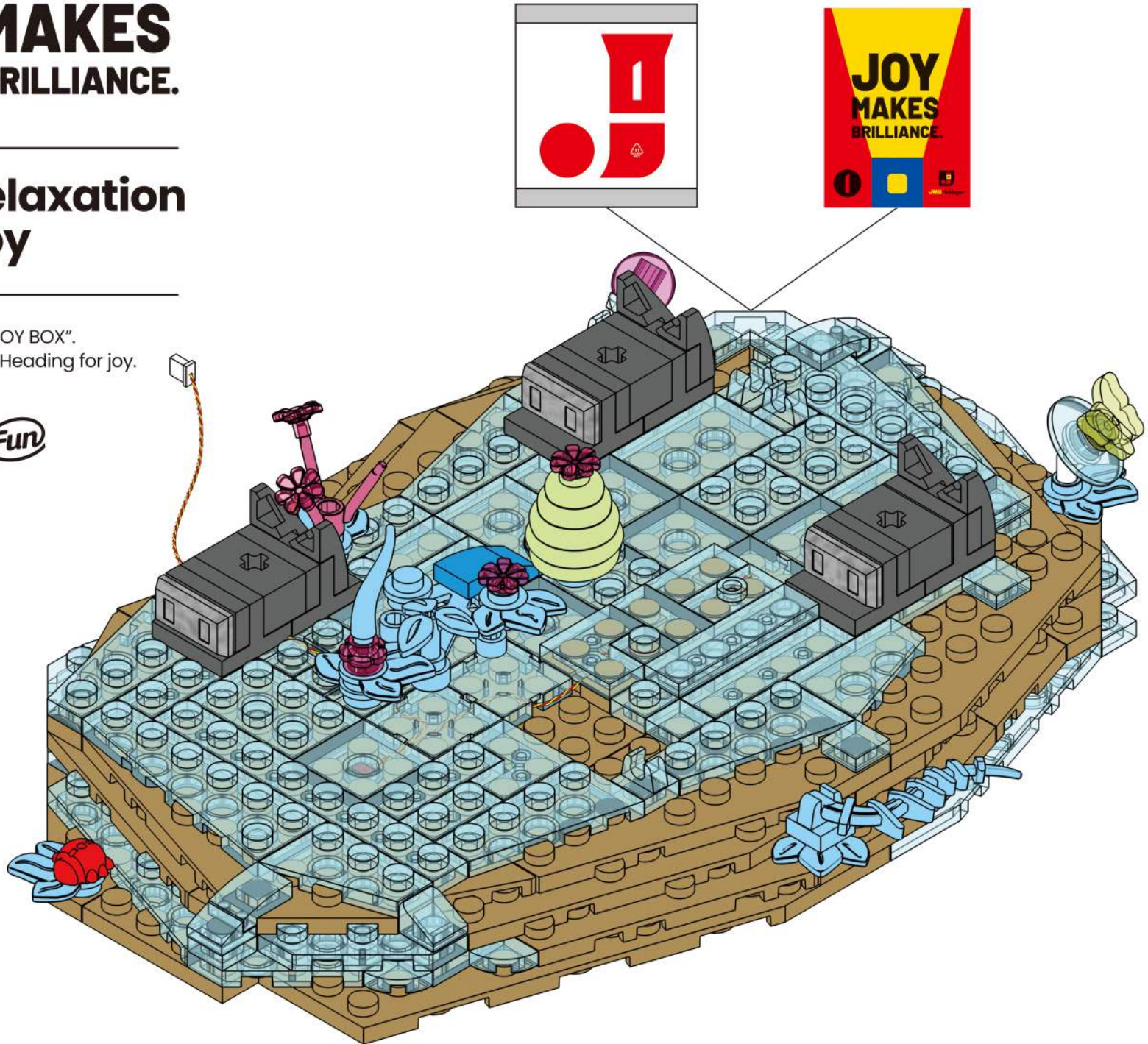

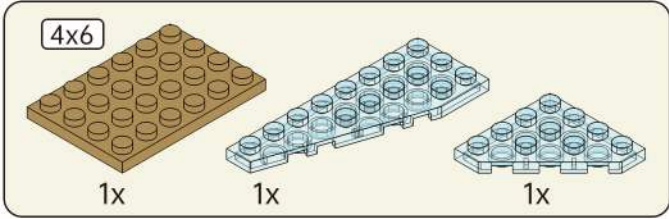

01

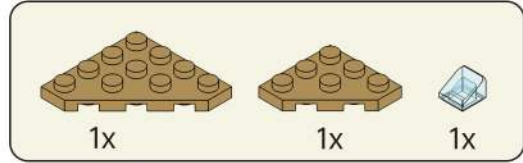
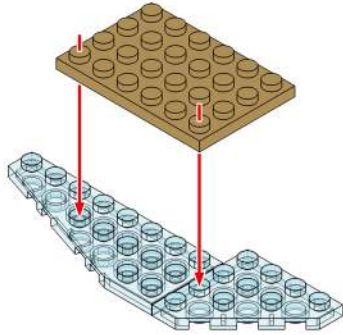

02

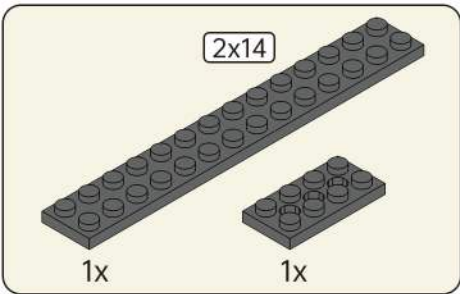
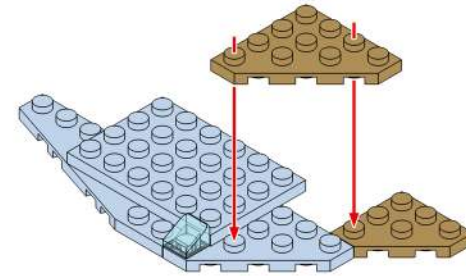

03

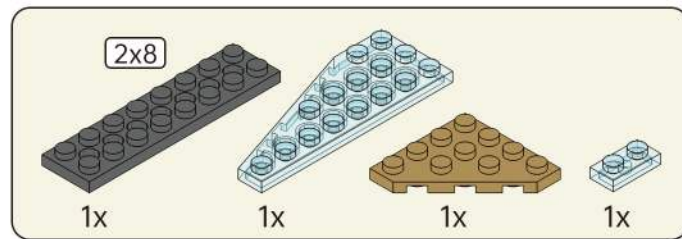
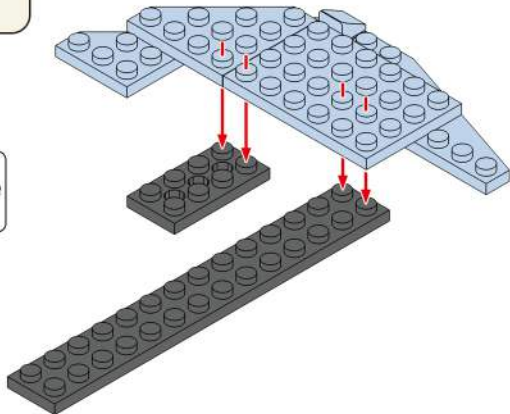

04

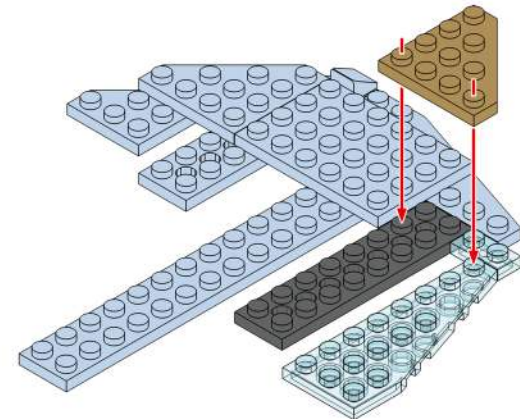

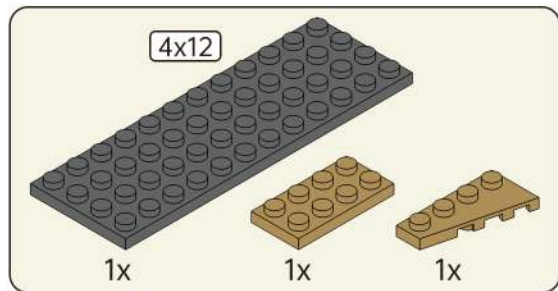

05

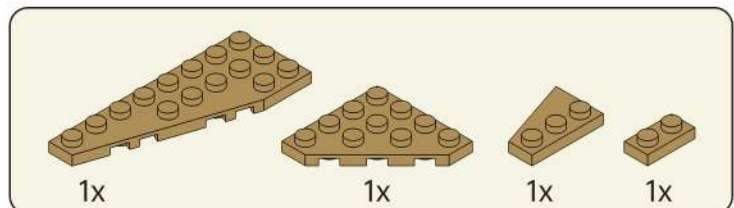
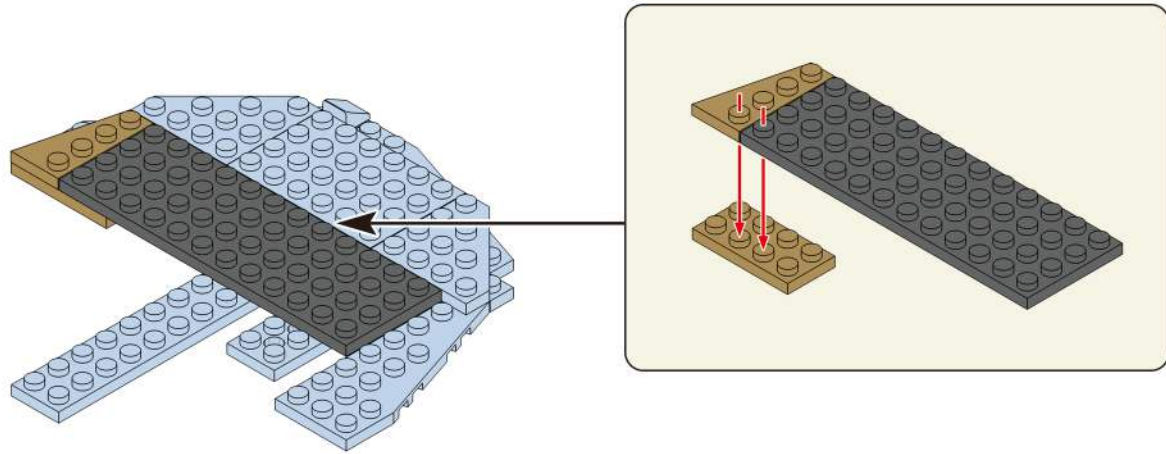

06

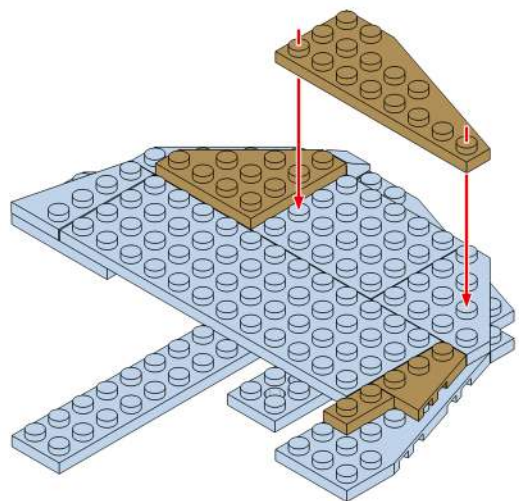

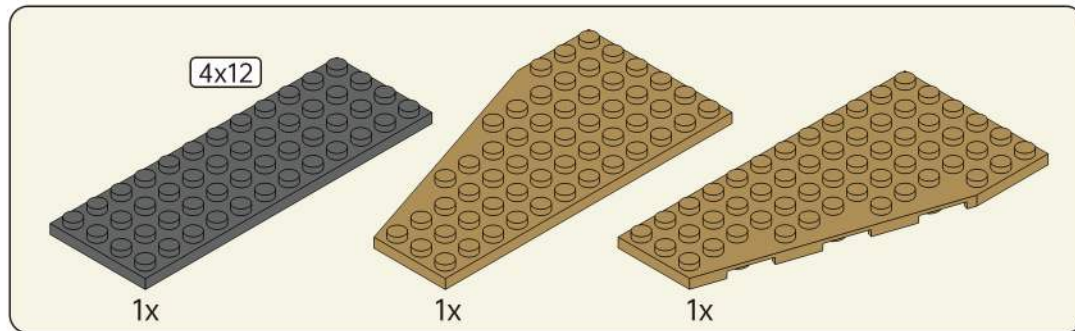

07

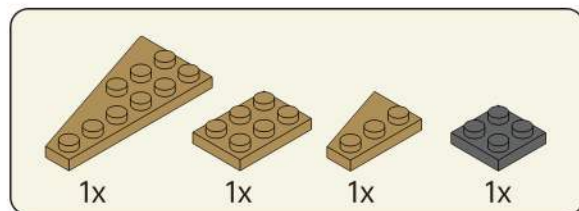
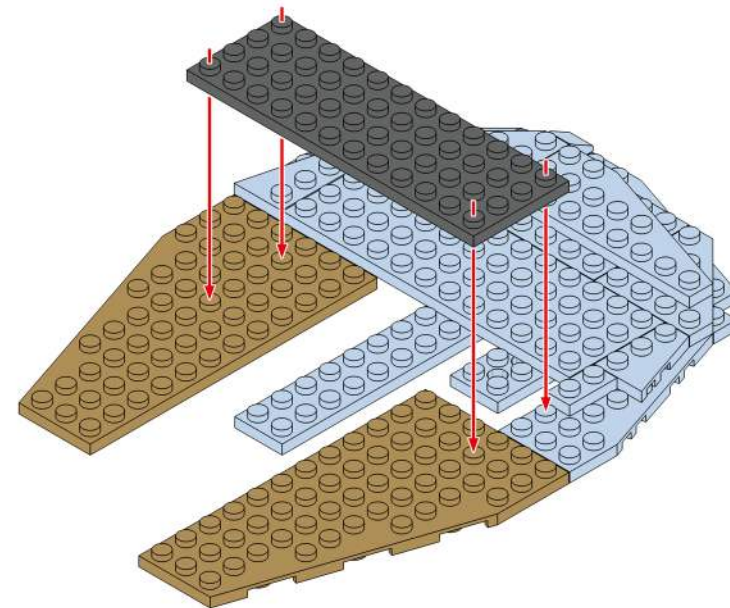

08

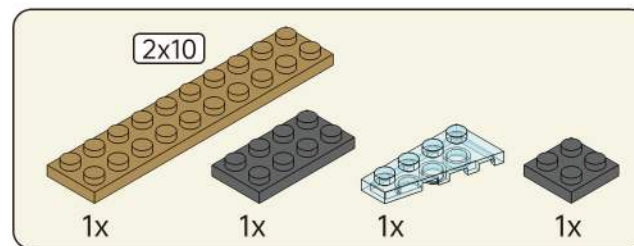
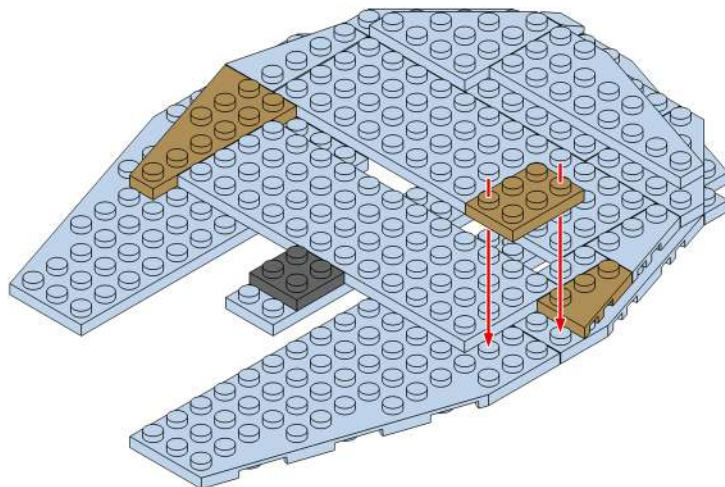

09

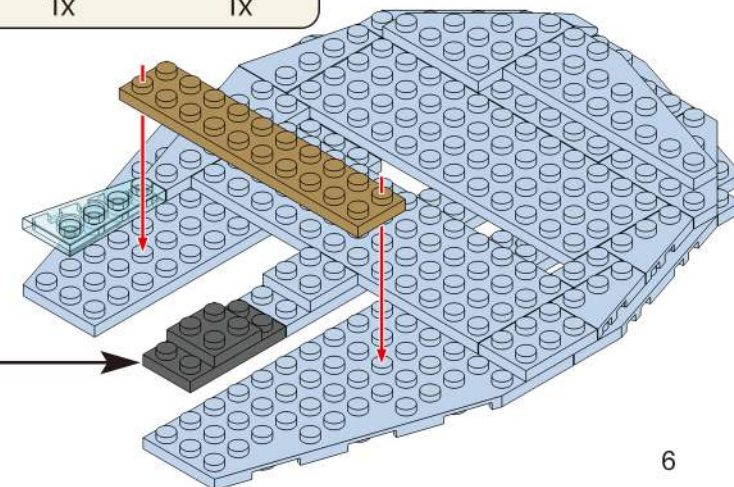
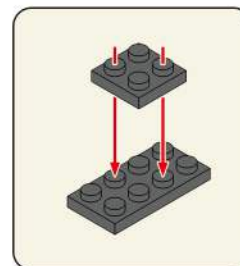

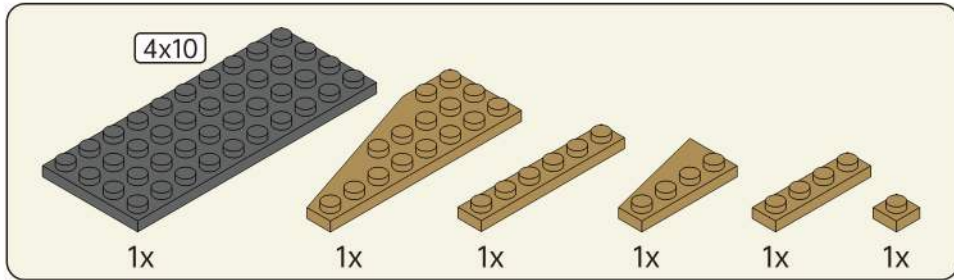

13

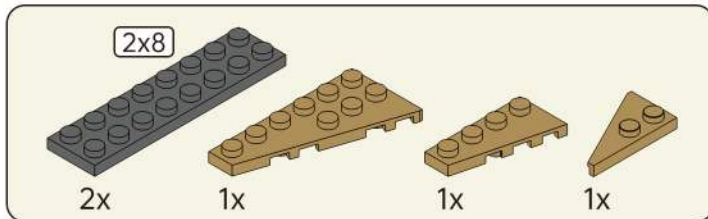
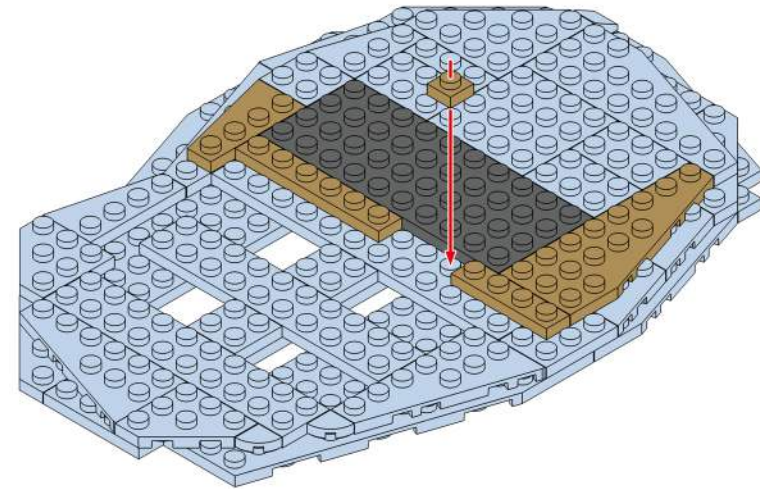

14

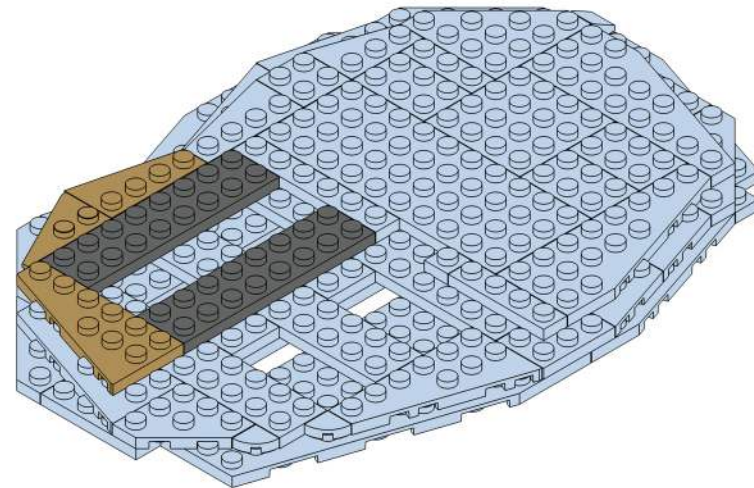

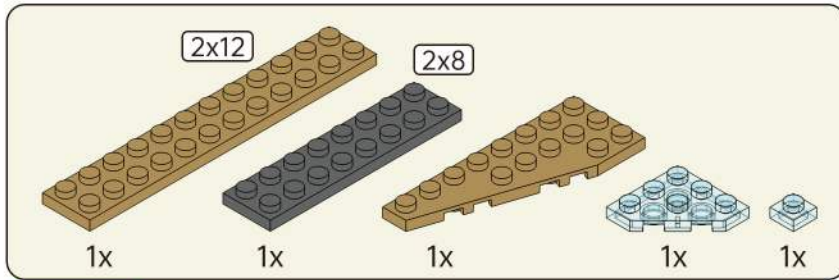

15

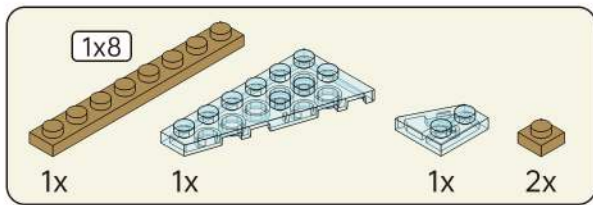
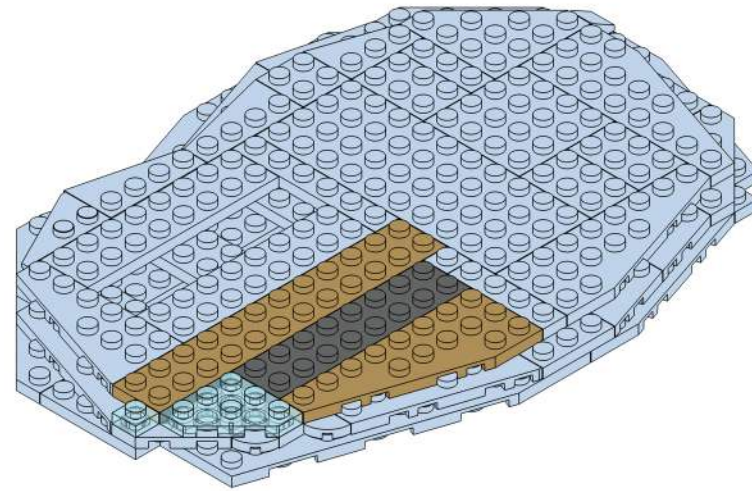

16

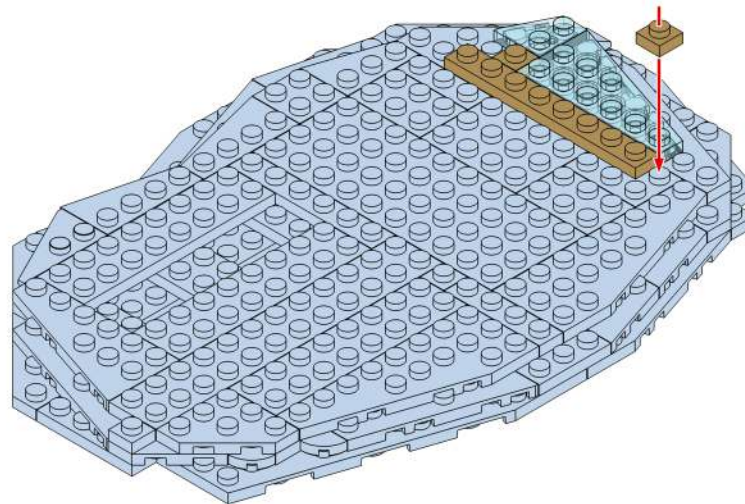

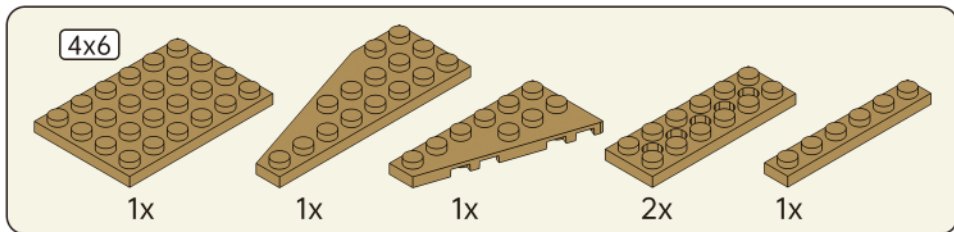

17

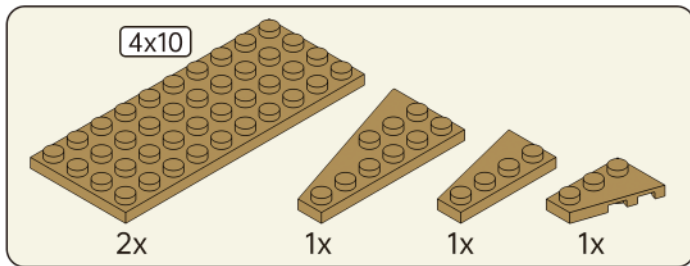
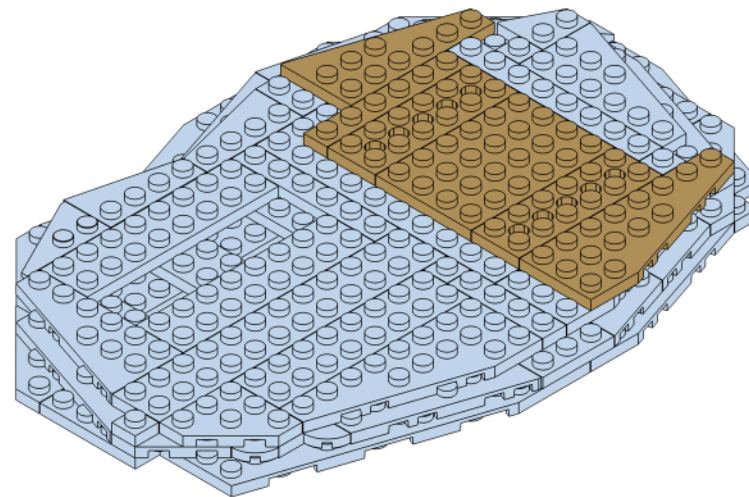

18

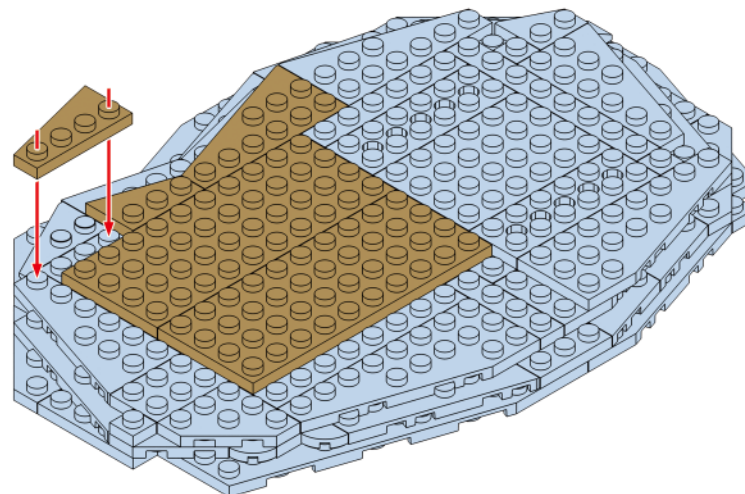

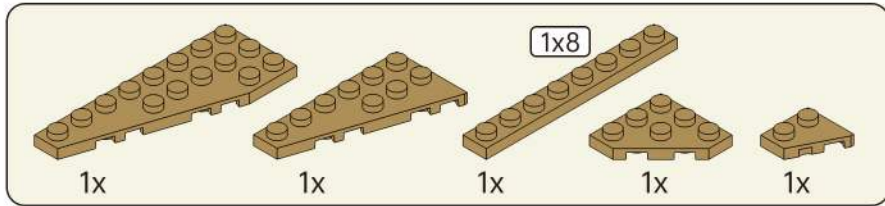

19

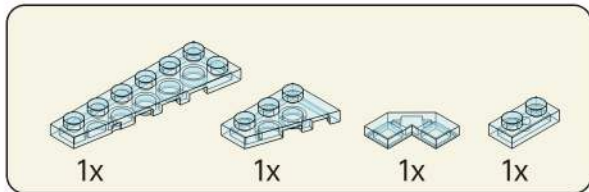
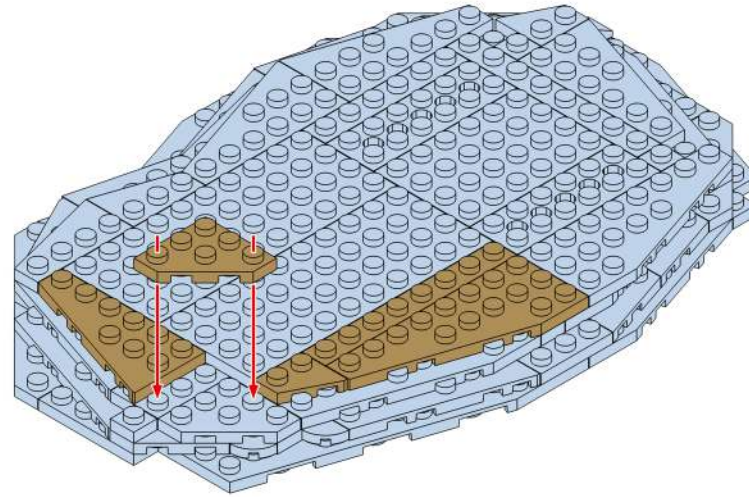

20

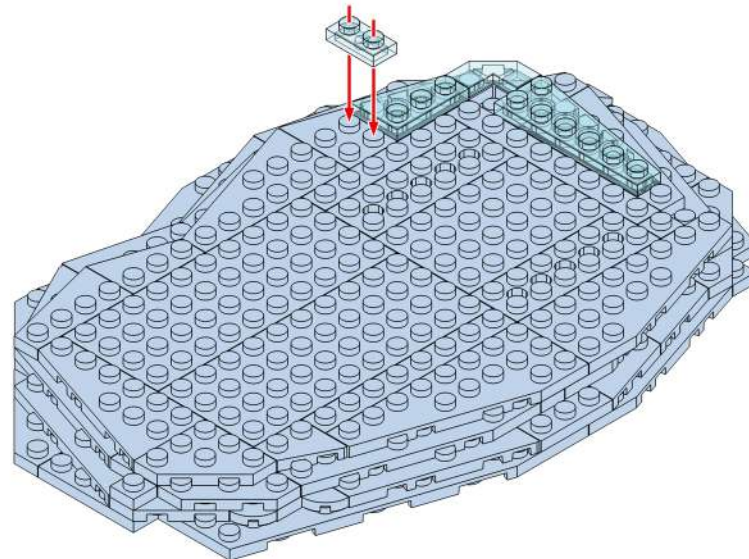

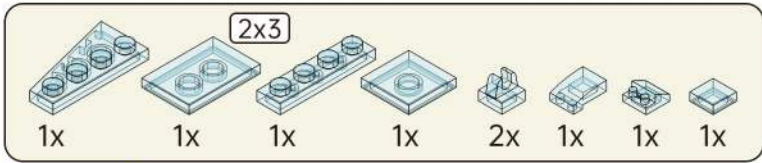

21

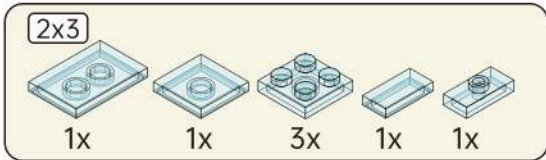
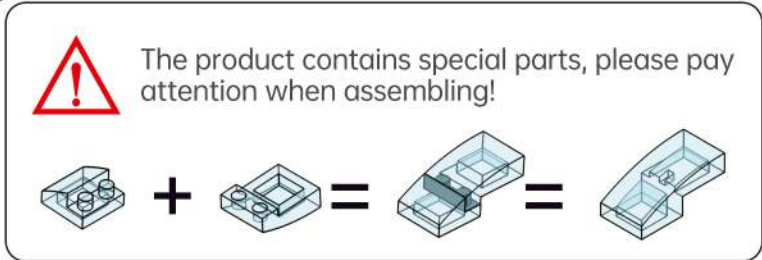
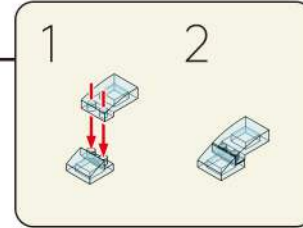
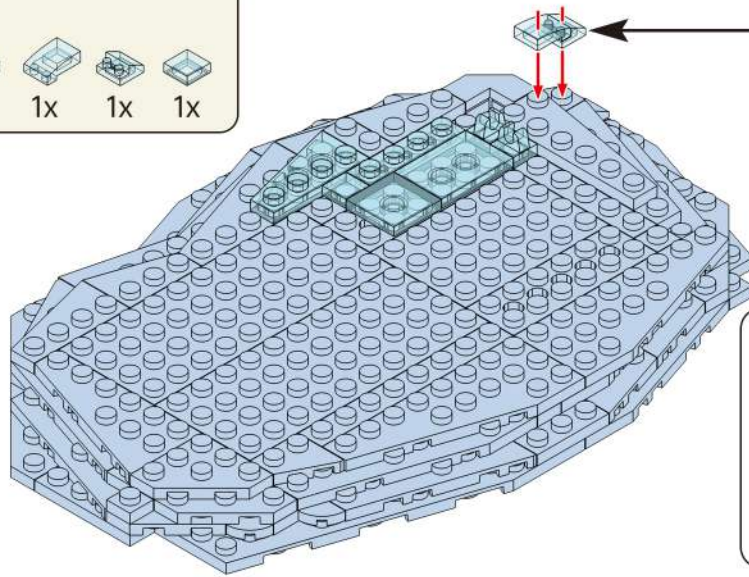

22

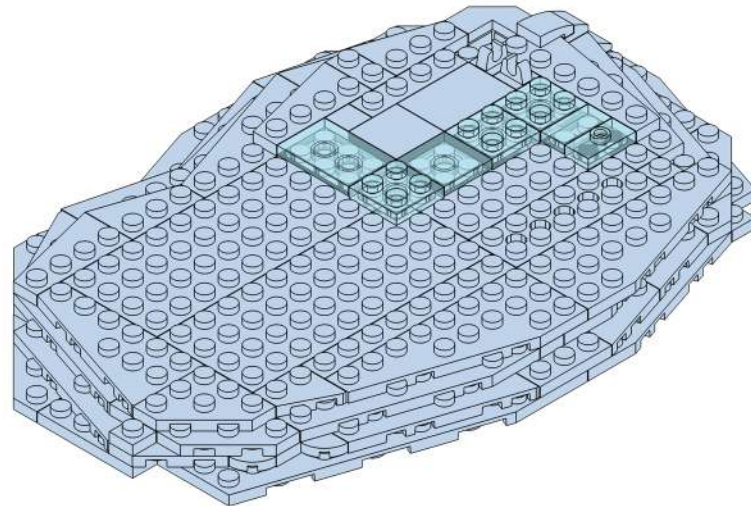

JOY MAKES BRILLIANCE

Ice blue Eisblau 1x

Green Grün 1x

White weiß 1x

2x 1x 1x

23

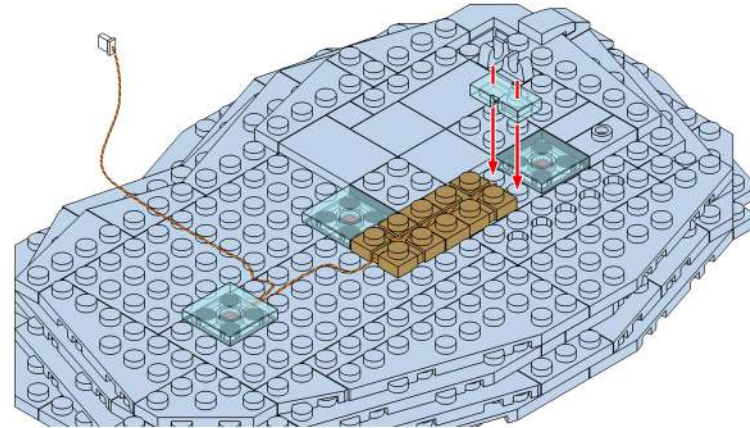

1x4

1x 1x 1x 1x 1x 3x

24

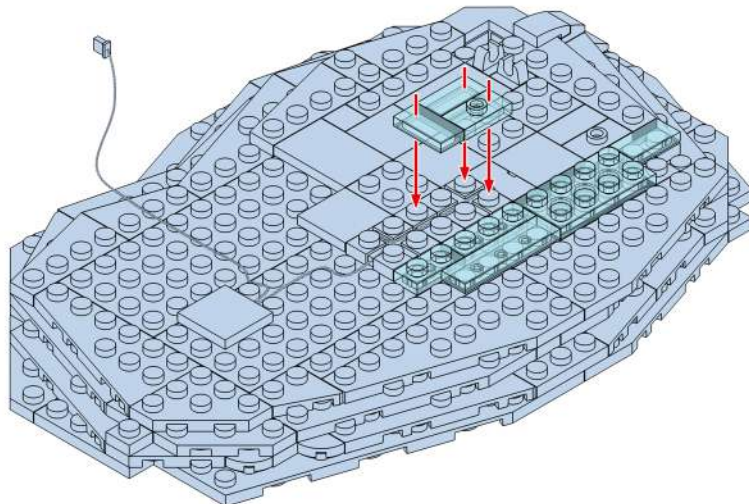

1x4

1x 1x 1x 1x 1x 1x 2x

25

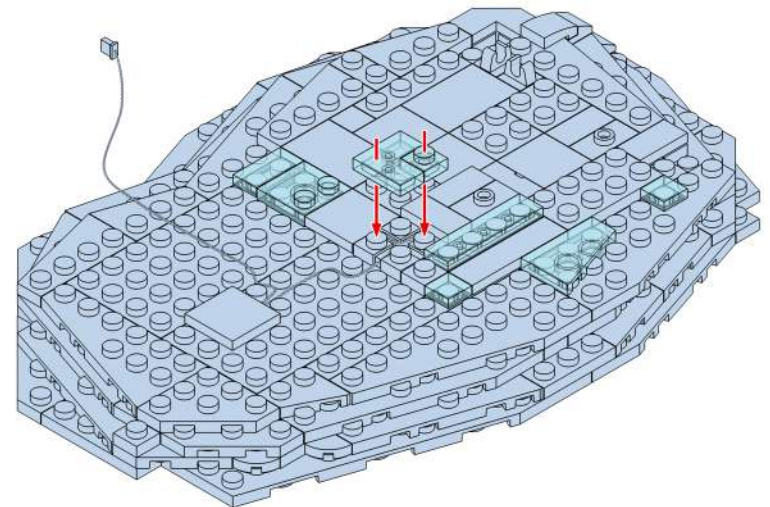

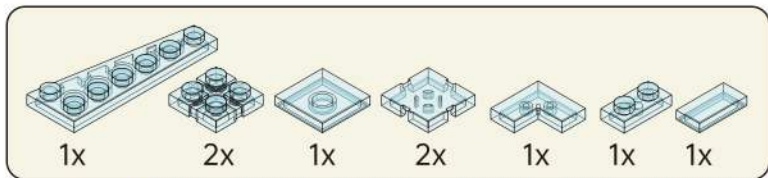

26

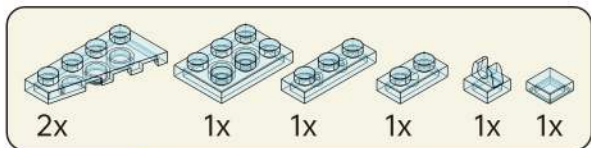
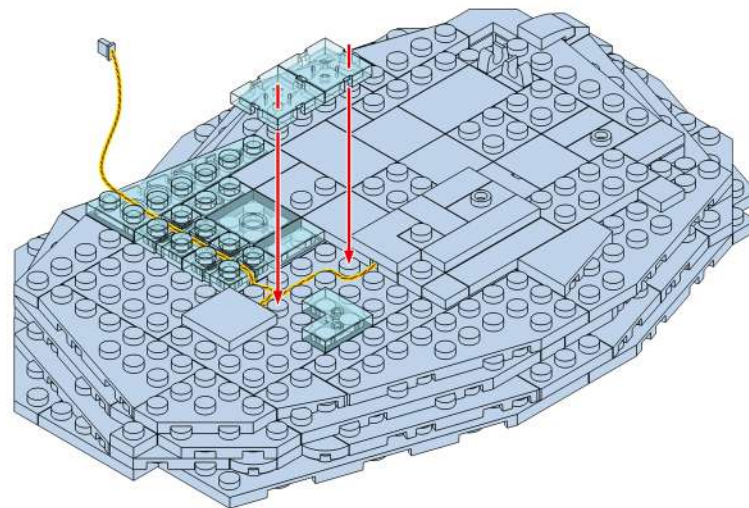



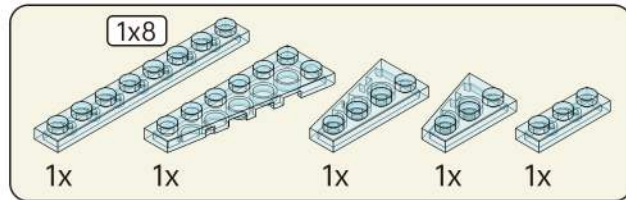
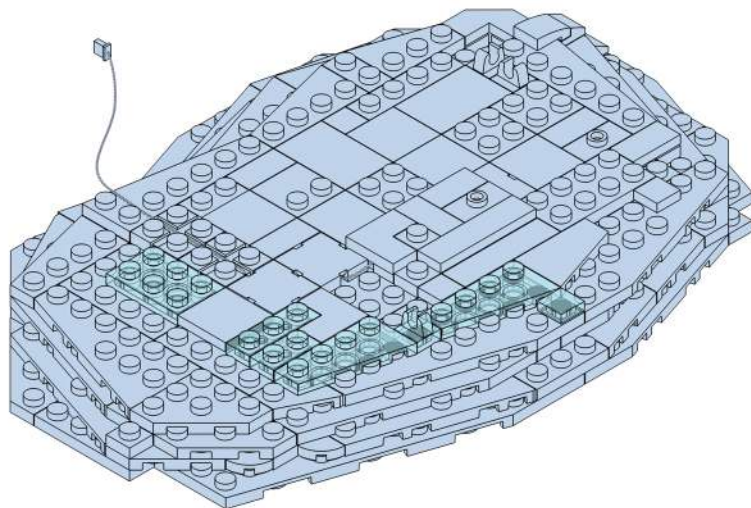

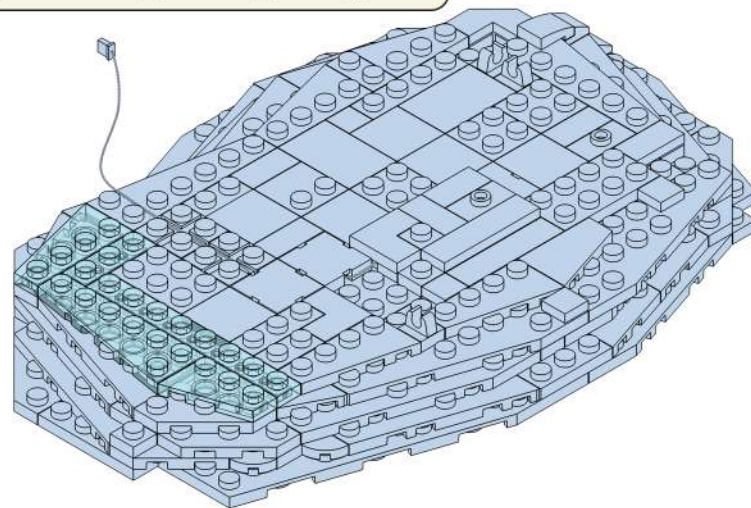

27









28

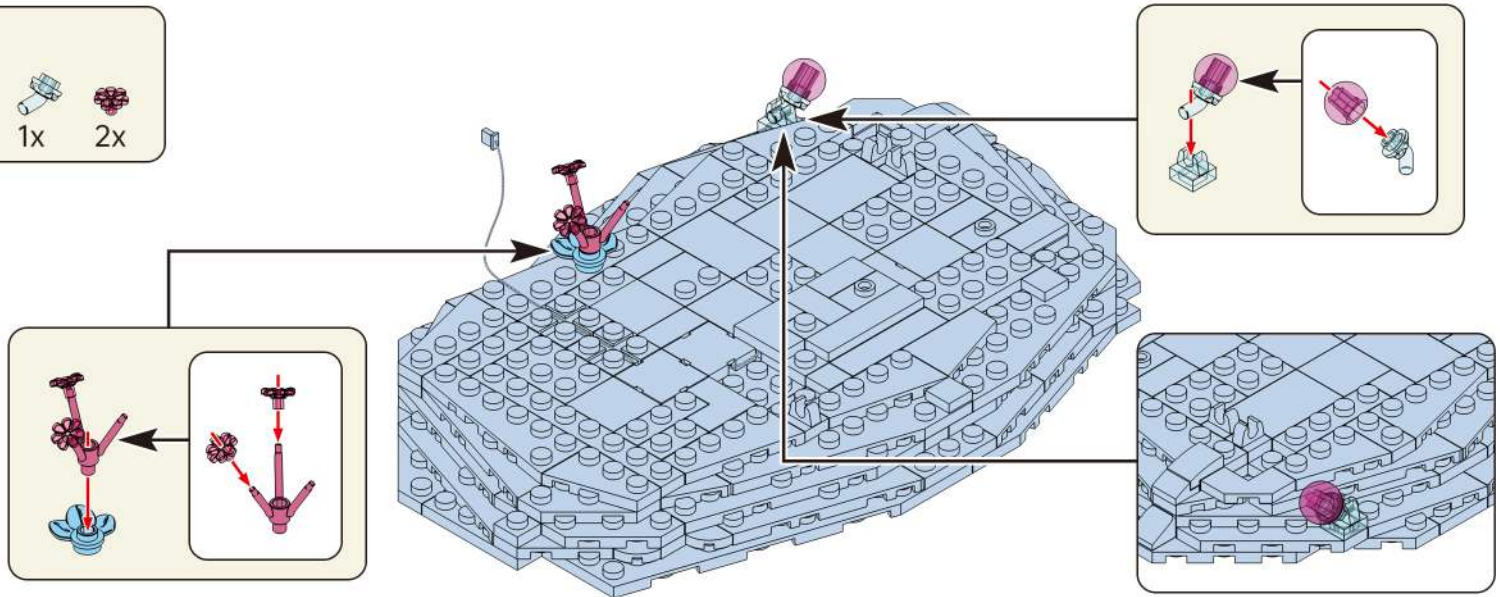

-  1x
-  1x
-  1x
-  1x
-  1x
-  2x

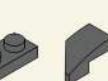
29



-  4x
-  2x
-  2x
-  2x
-  2x
-  2x
-  2x

30

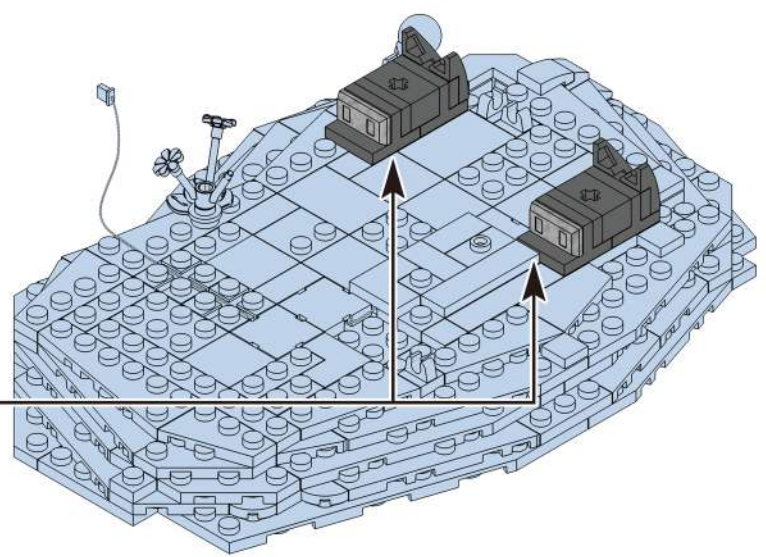
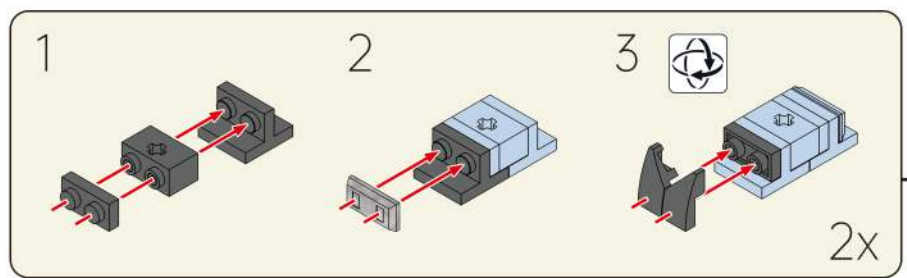

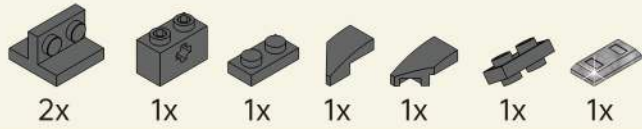

31

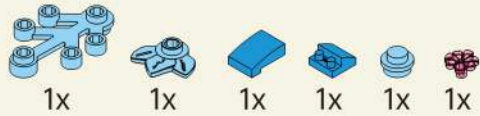
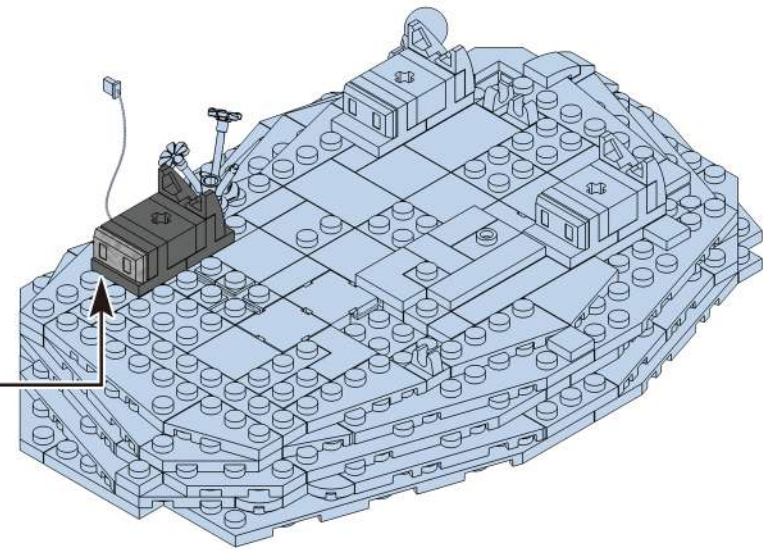
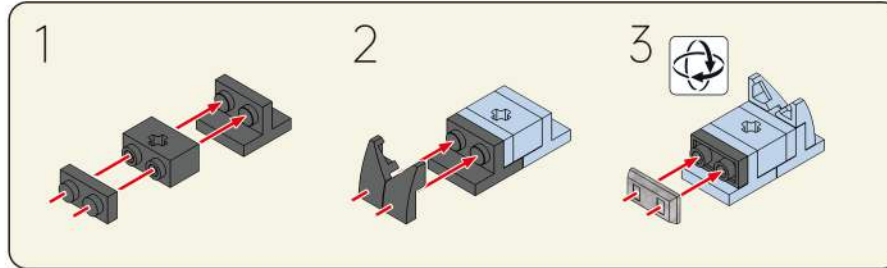

32

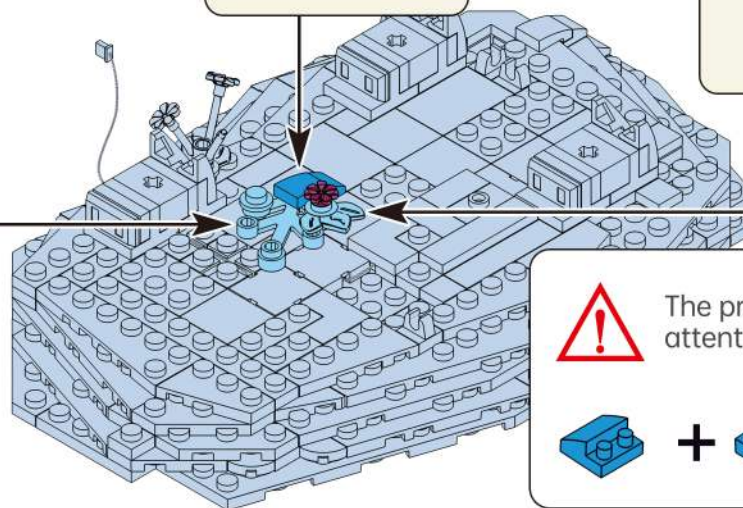
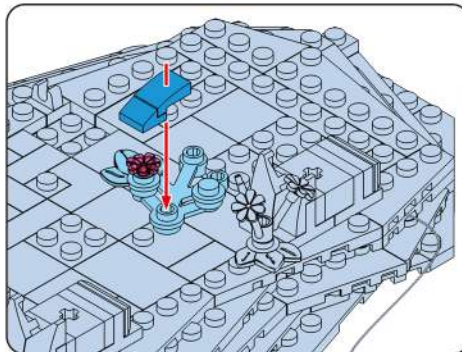
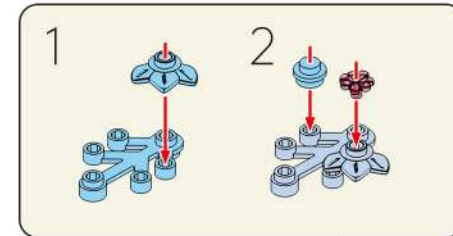
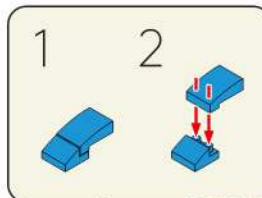

The product contains special parts, please pay attention when assembling!

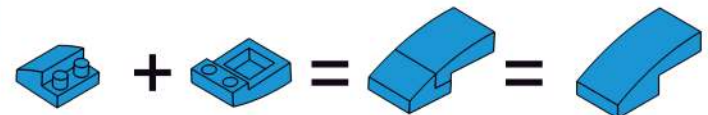

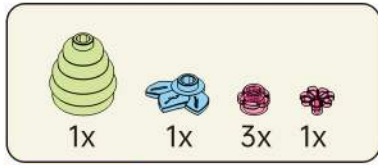

33

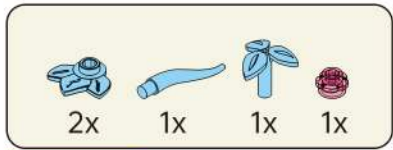
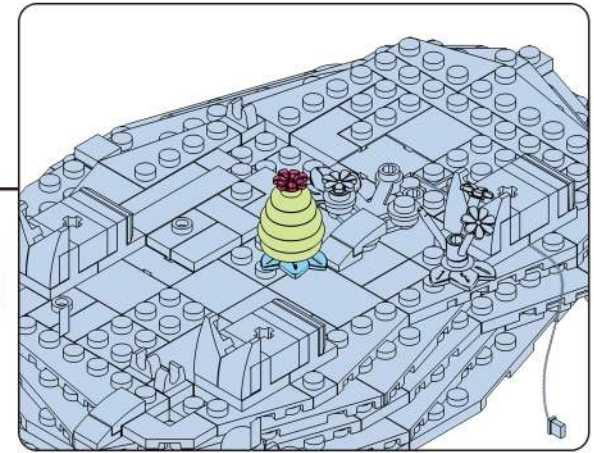
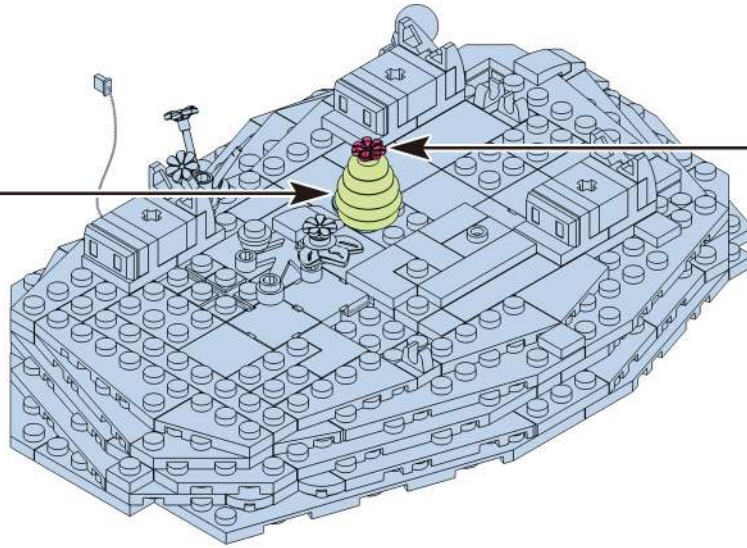
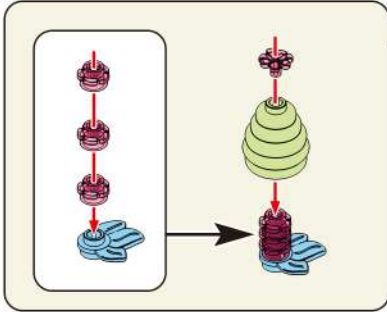

34

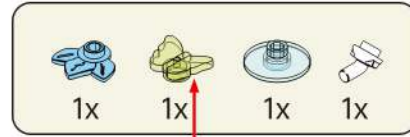
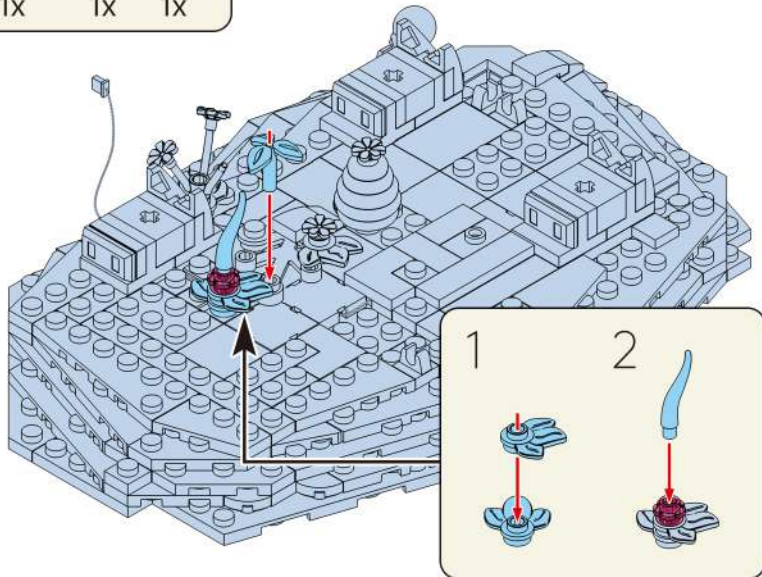

35

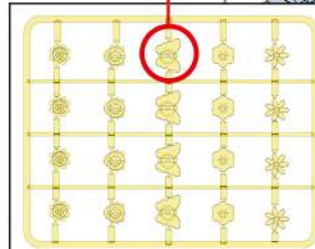

Need to disassemble the accessories required from the accessories board

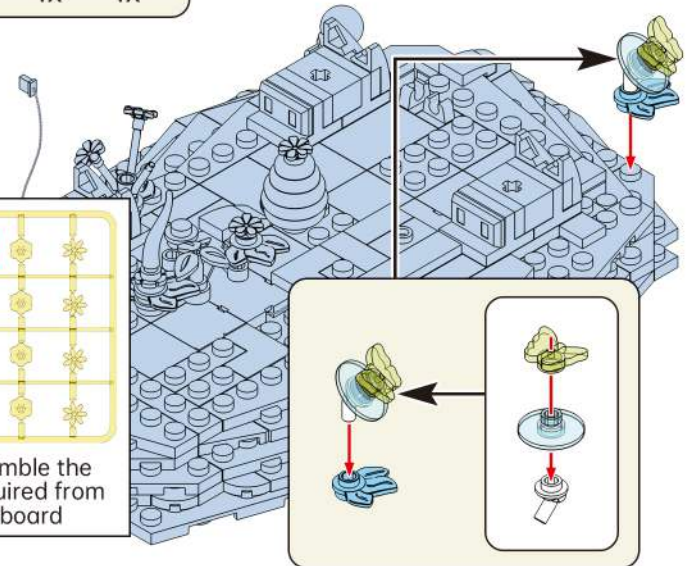

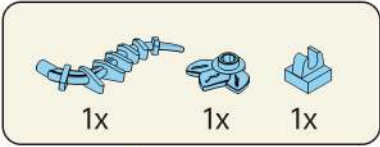

36

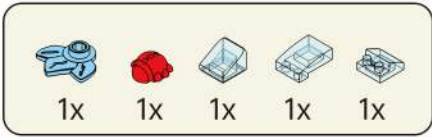
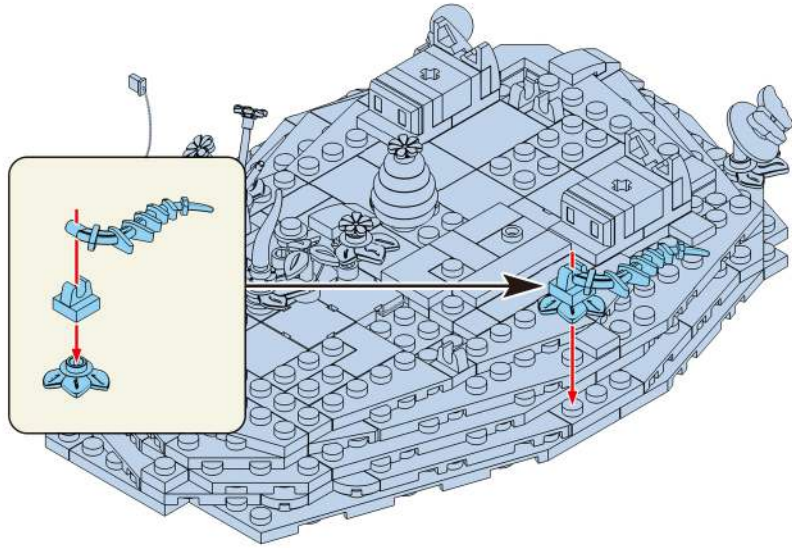

37

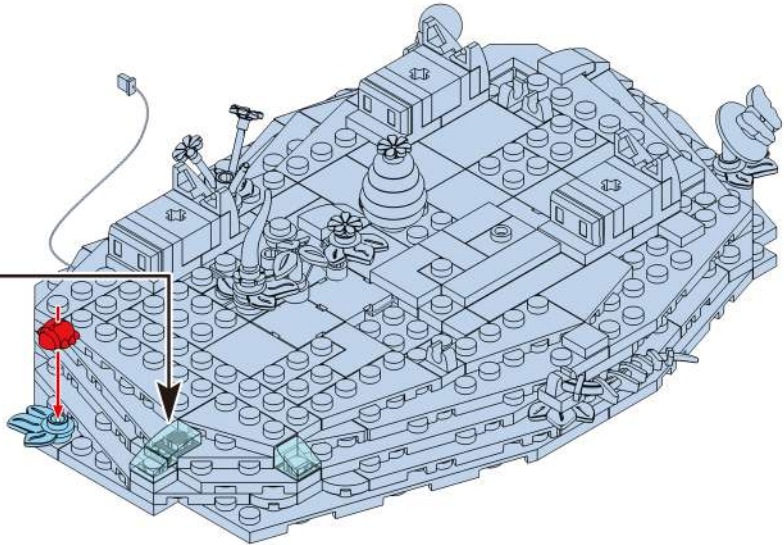
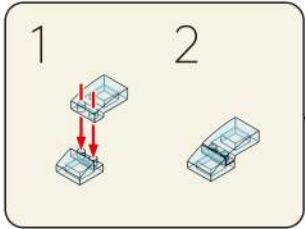

JOY MAKES BRILLIANCE.

Embrace Relaxation Embrace Joy

Every adultescent needs a "JOY BOX".
Please, open your JOY BOX ! Heading for joy.

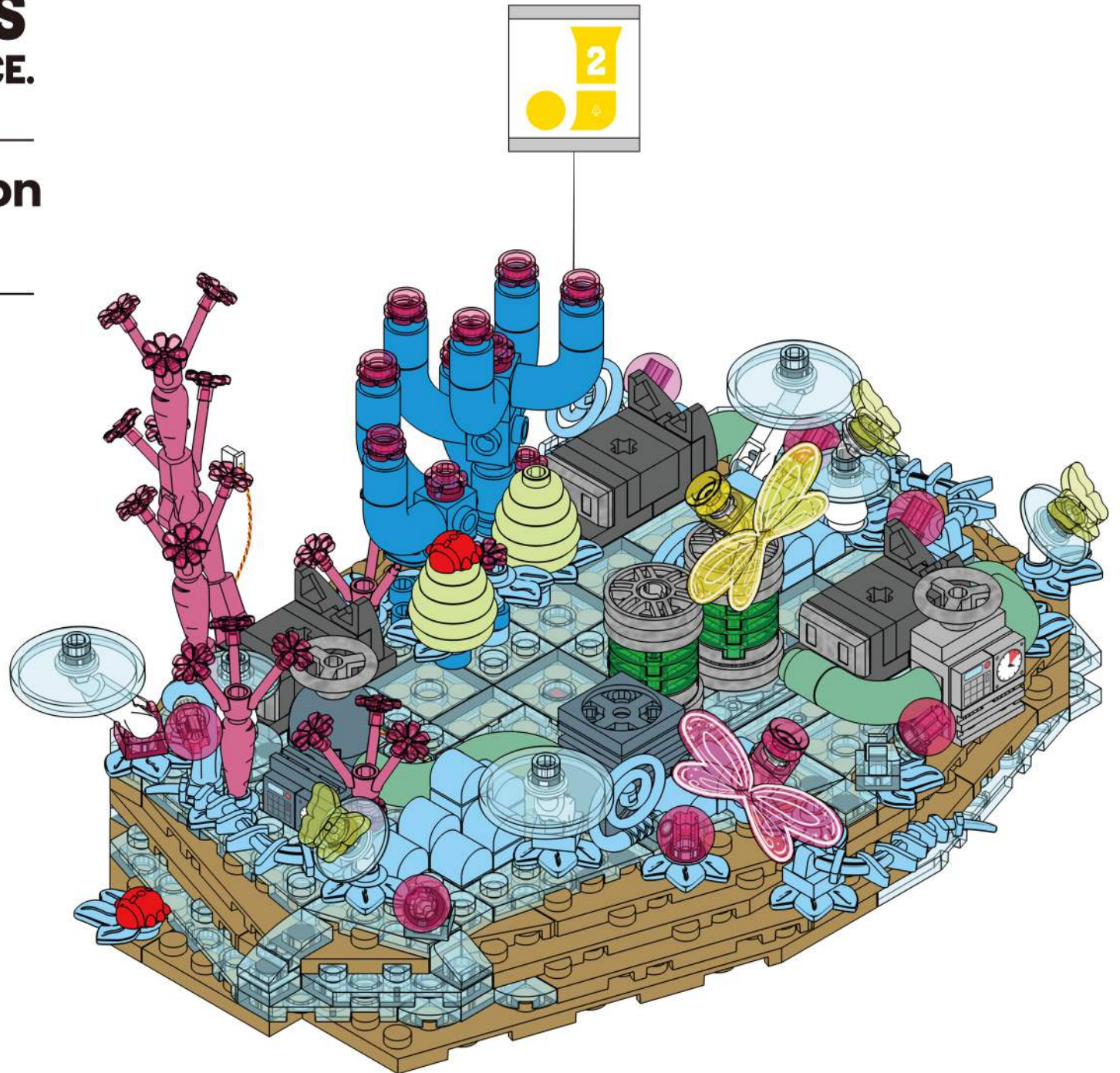

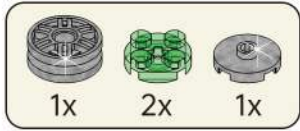

38

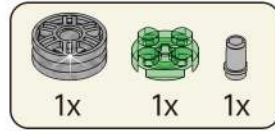
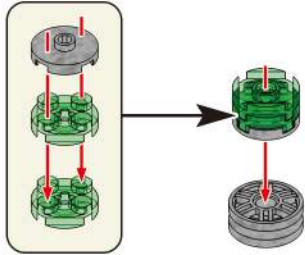

39

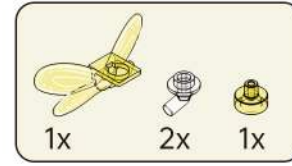

40

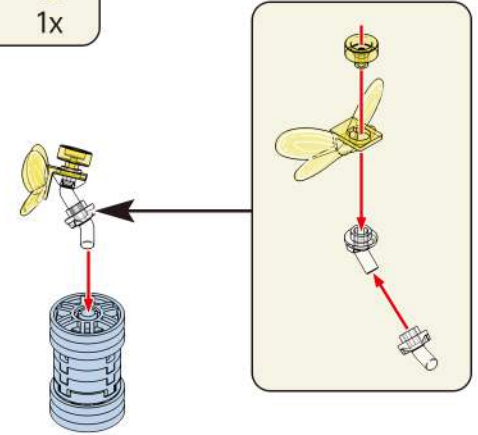

41

40

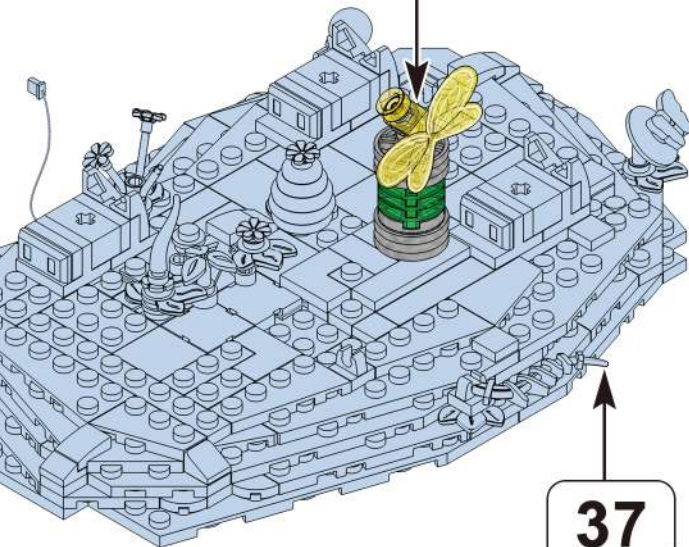

37

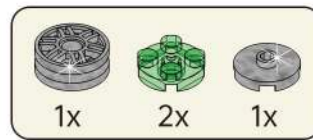

42

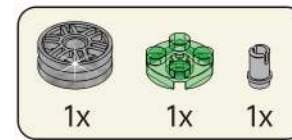
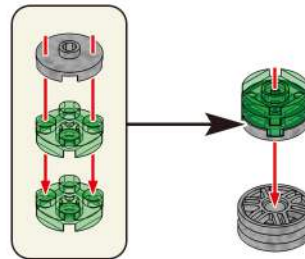

43



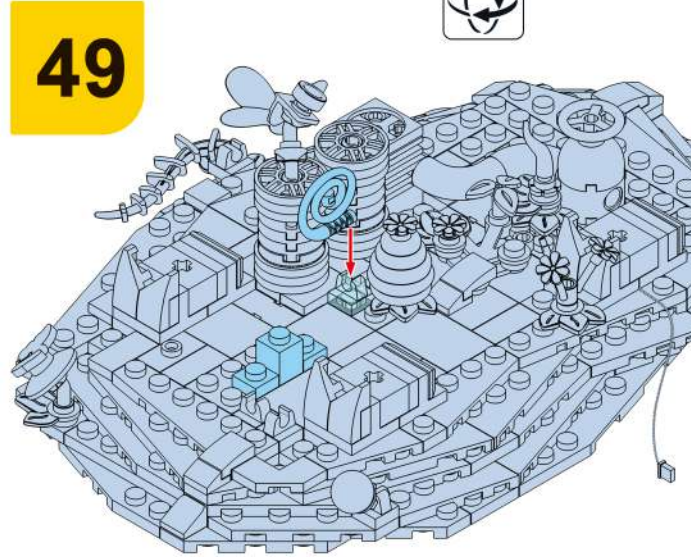
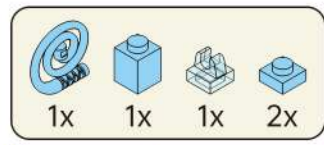
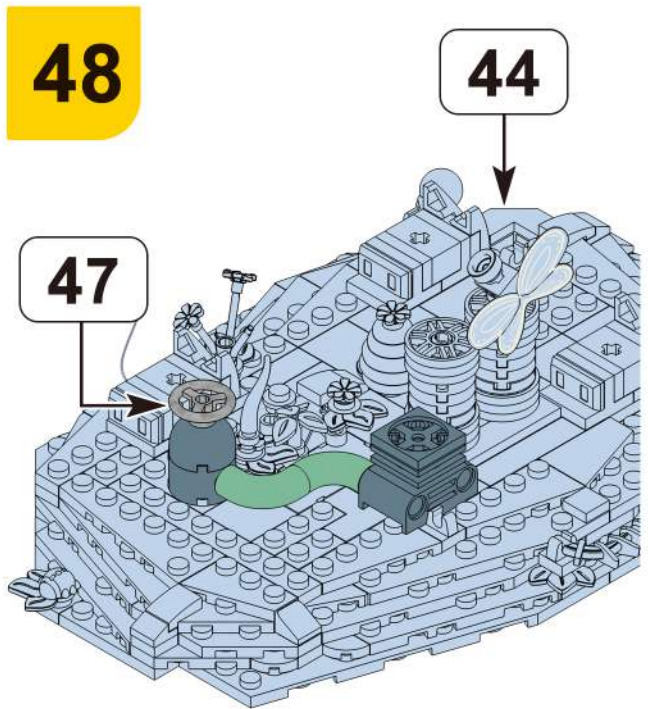
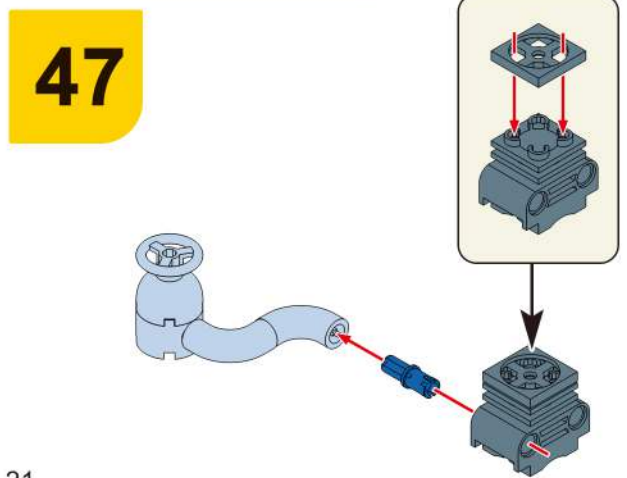
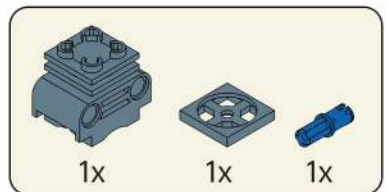
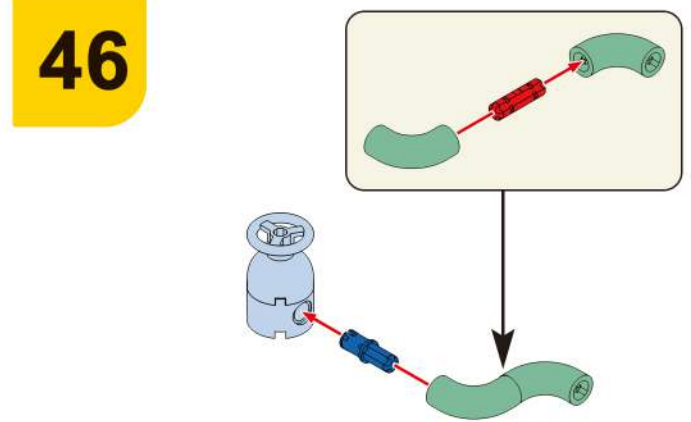
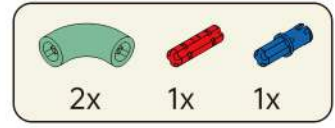
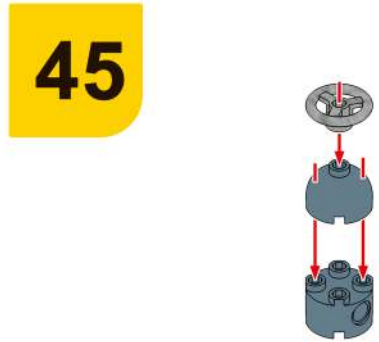
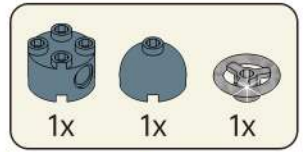
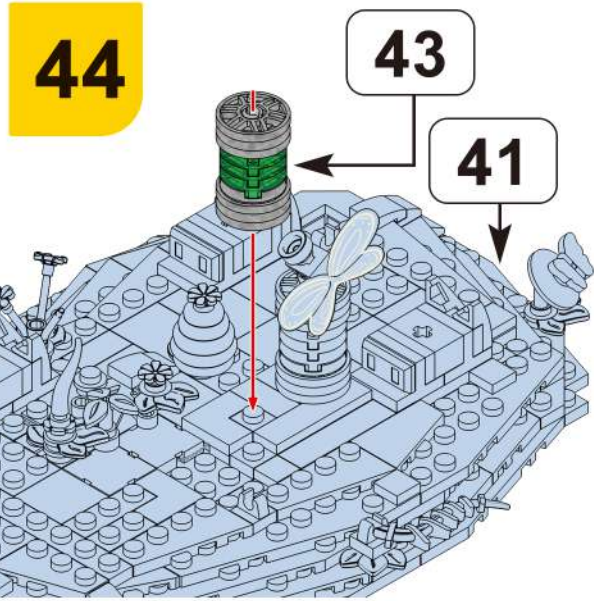

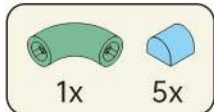

50

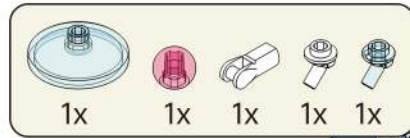
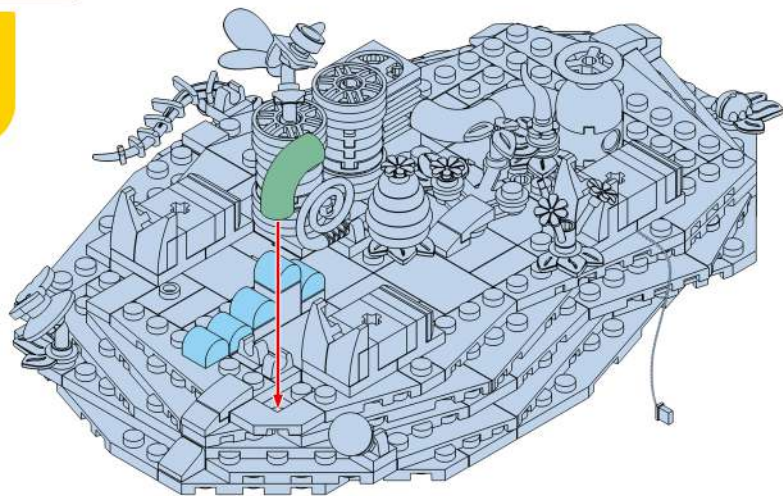

51

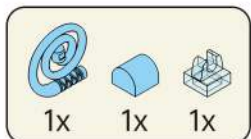
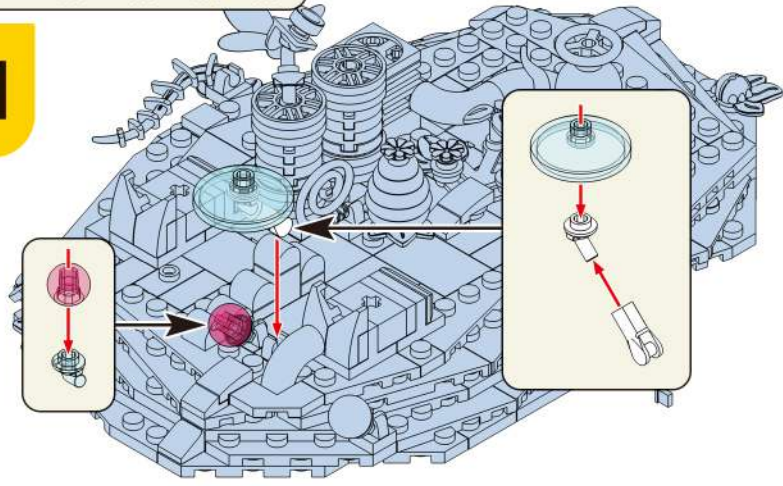

52

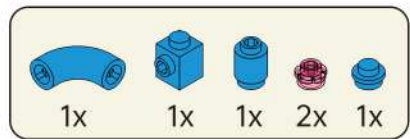
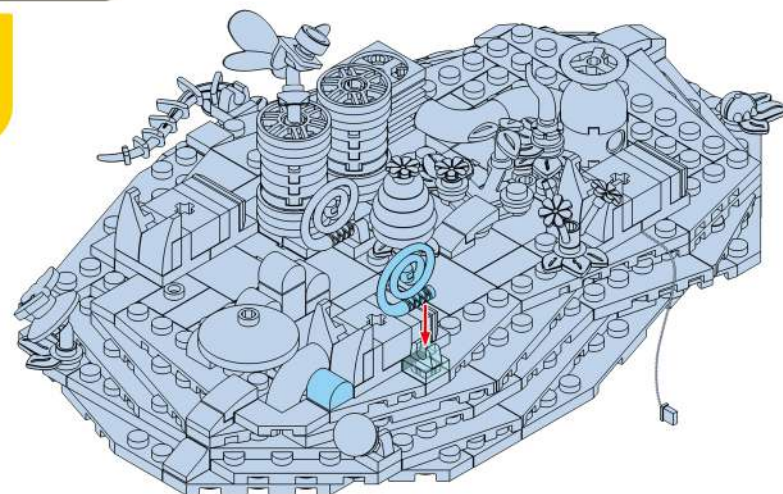

53

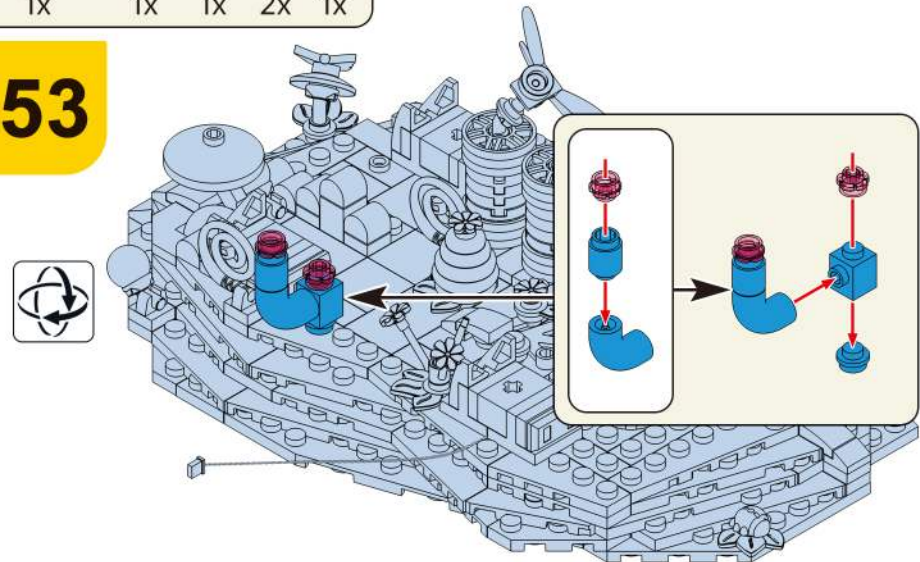

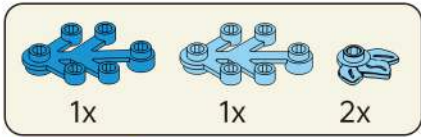

54

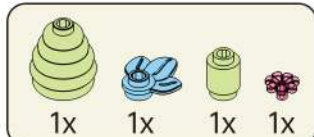
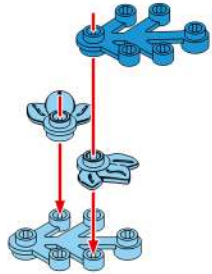

55

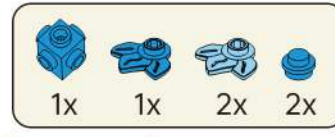
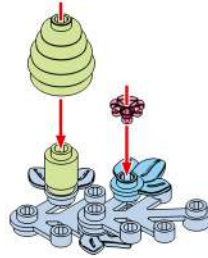

56

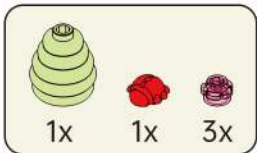
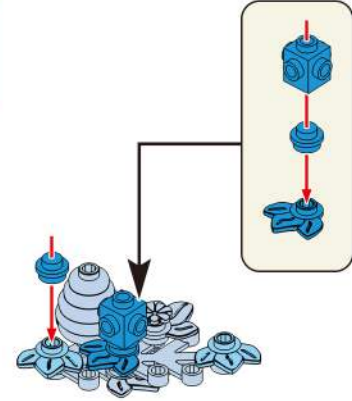

57

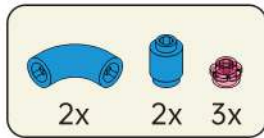
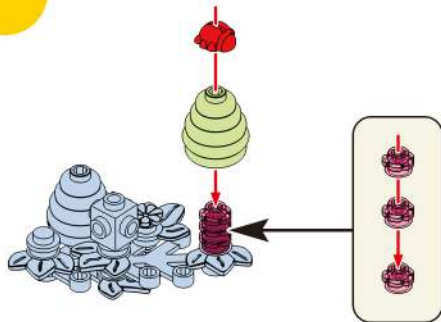

58

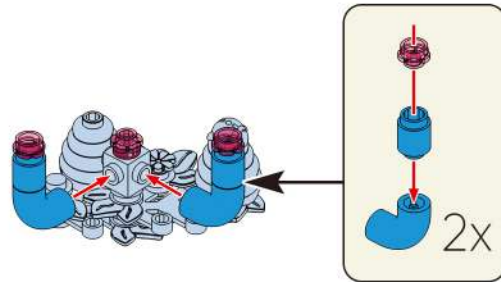

59

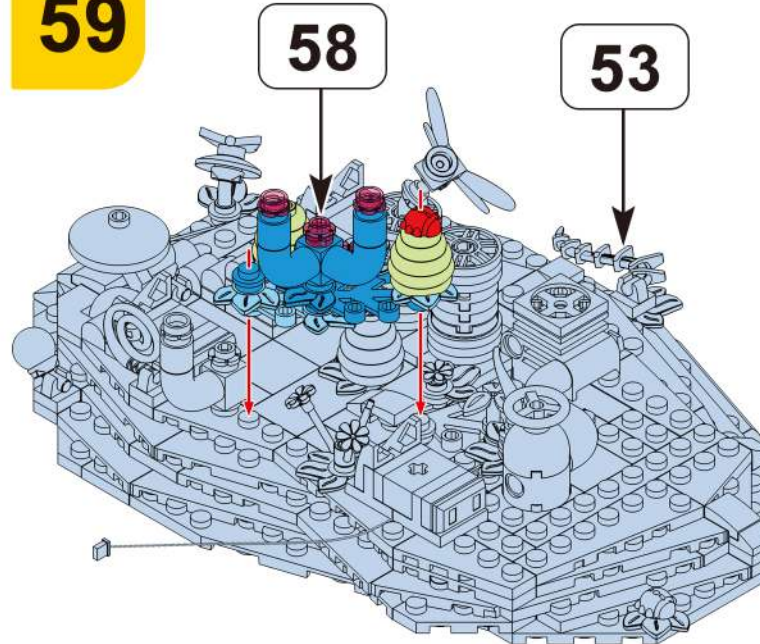

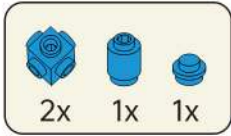

60

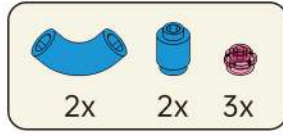

61

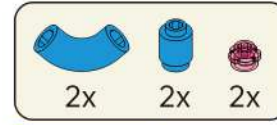
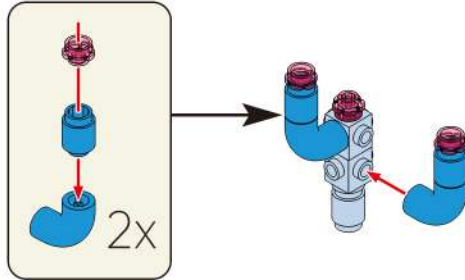

62

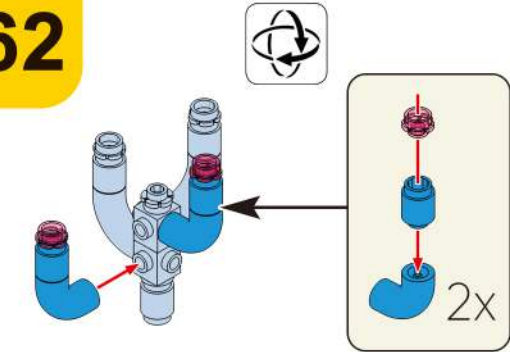

63

62

59

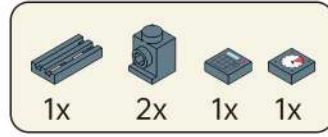
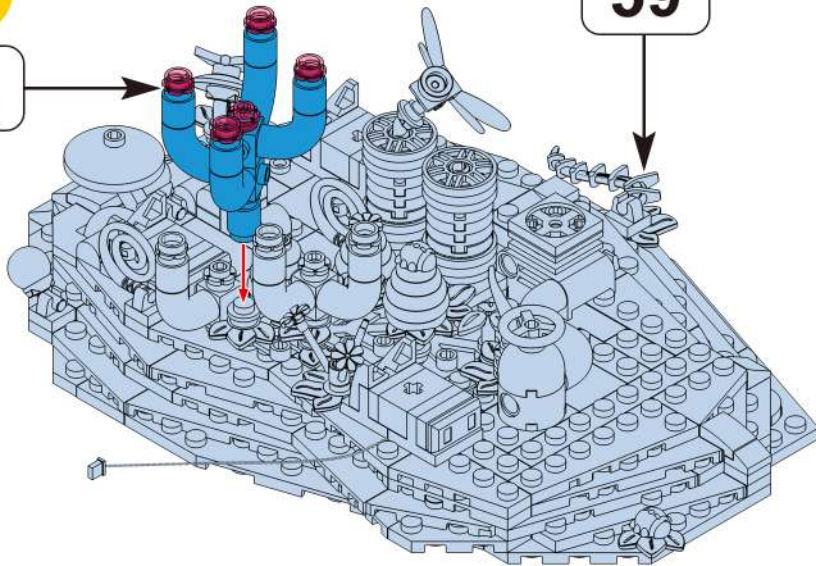

64

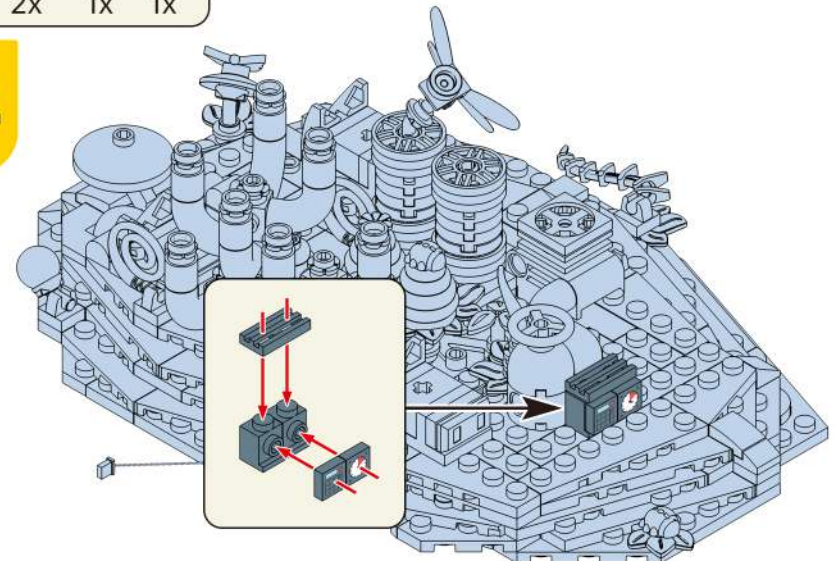

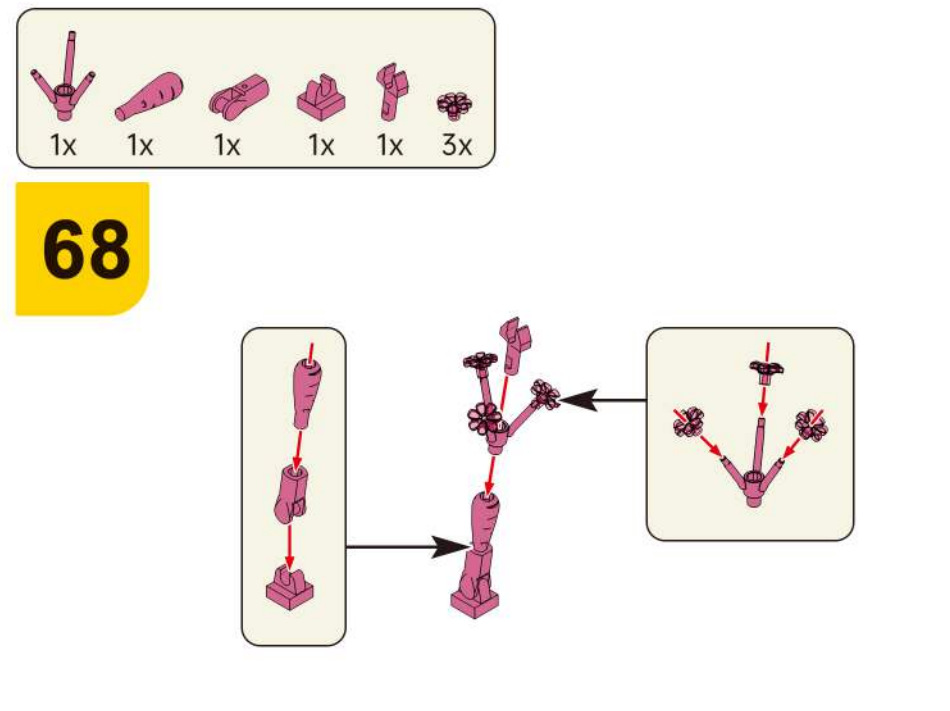
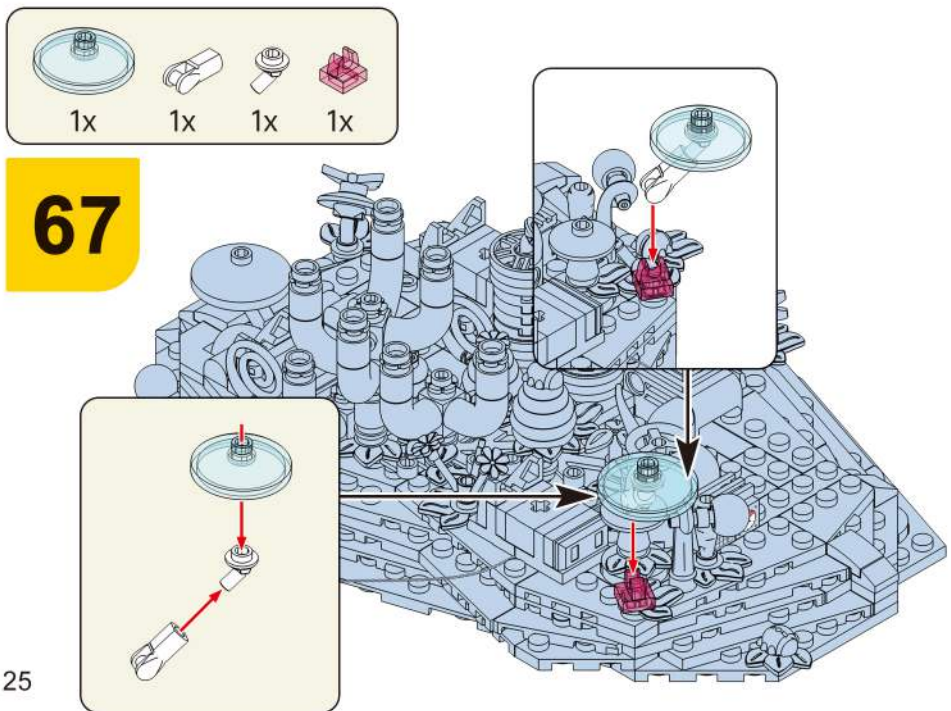
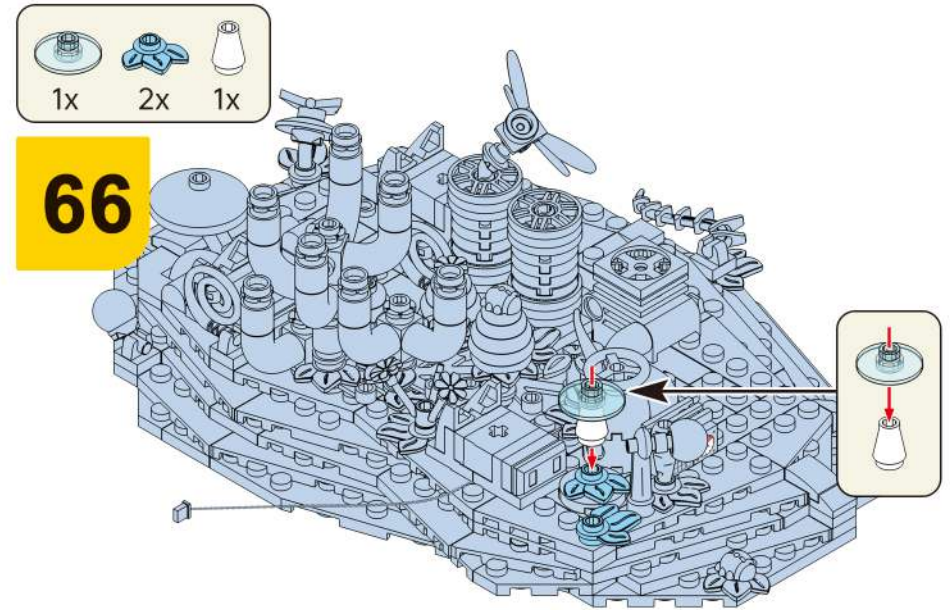
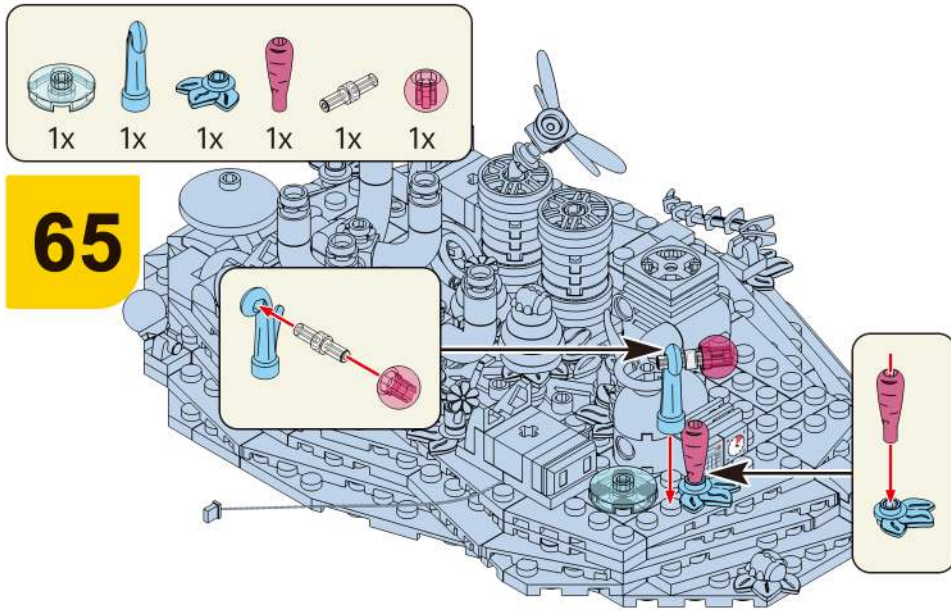

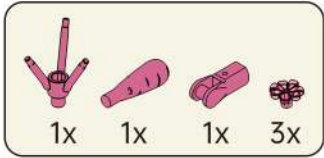

69

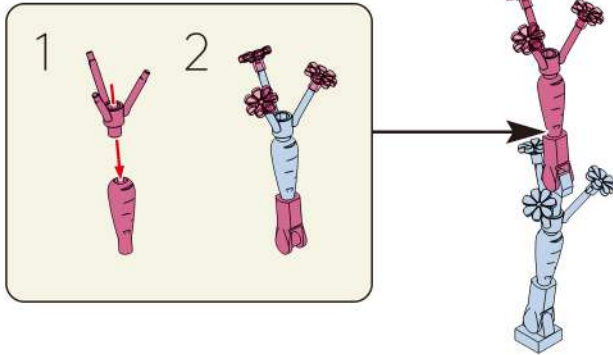

70

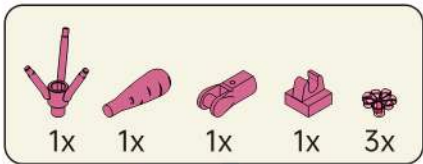
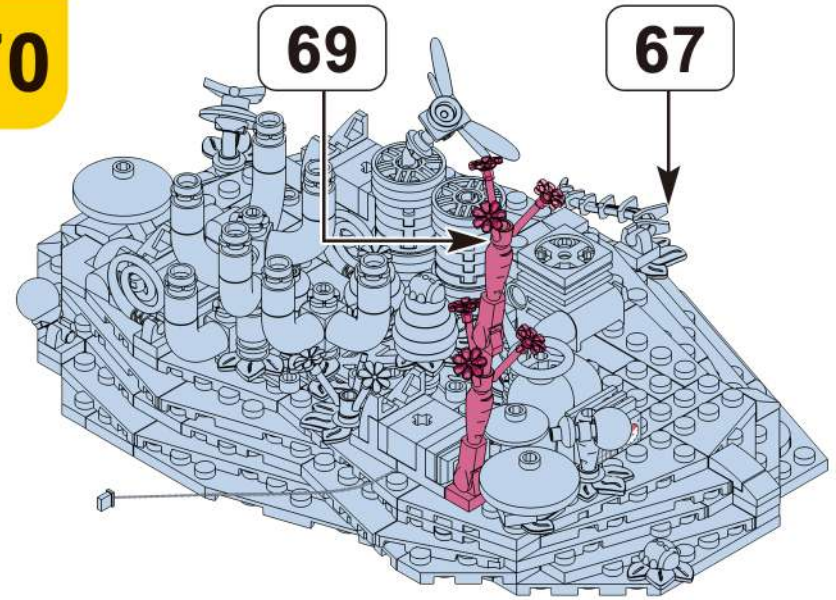

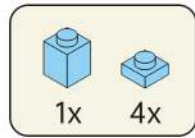
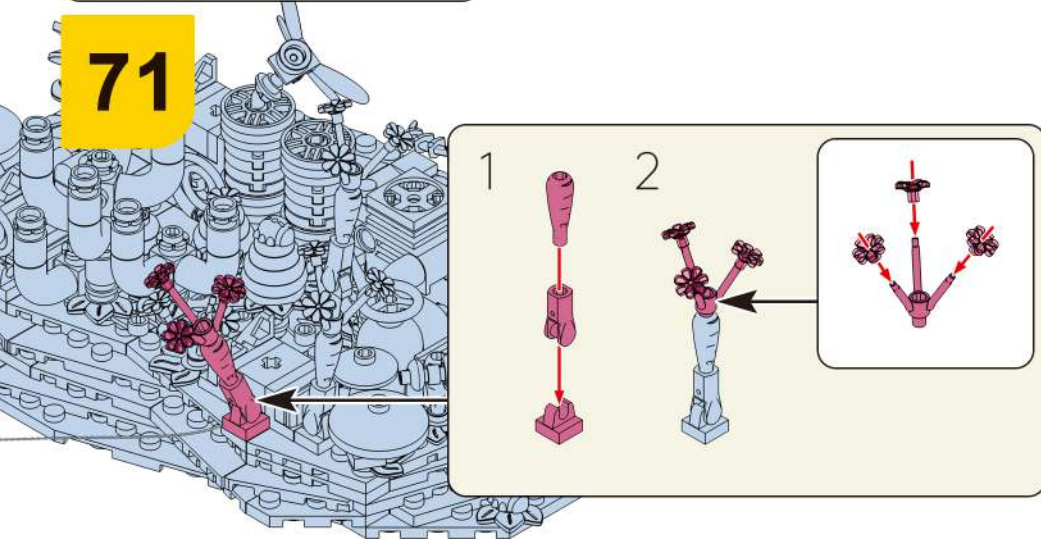

71



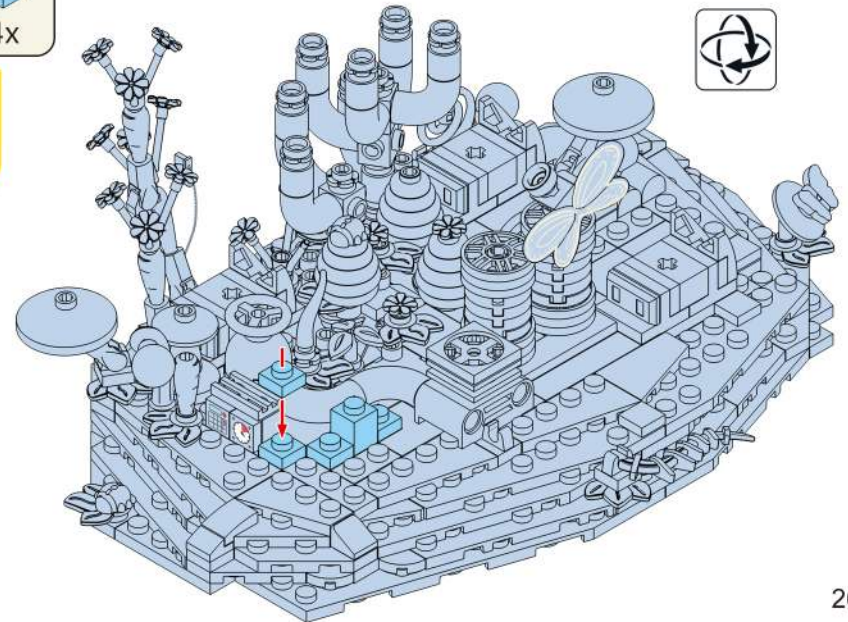



72

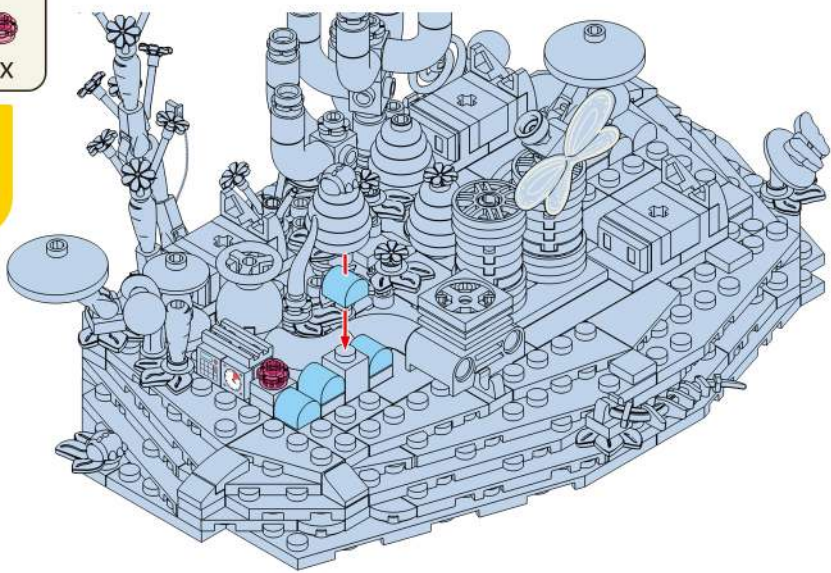

-  4x
-  1x



73



-  1x
-  1x
-  2x
-  1x

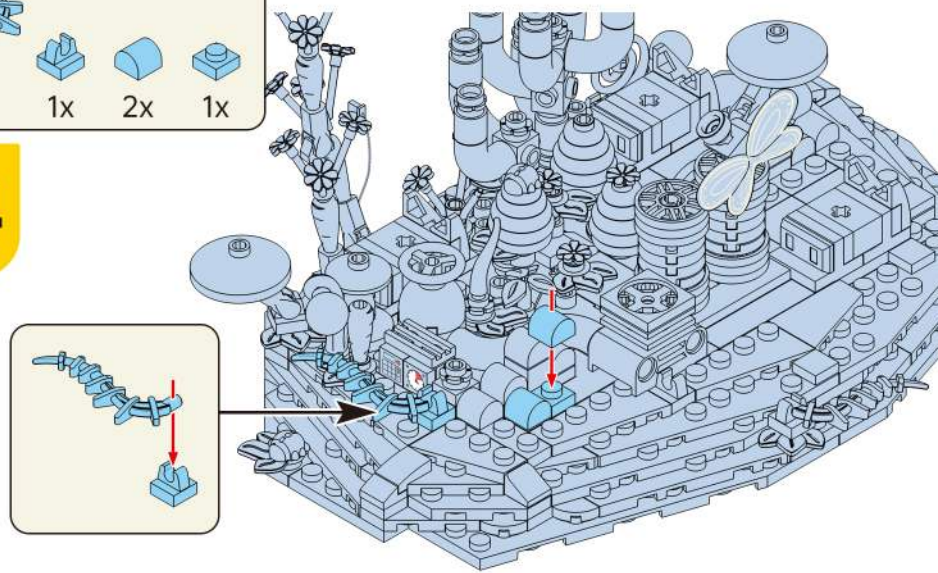



74

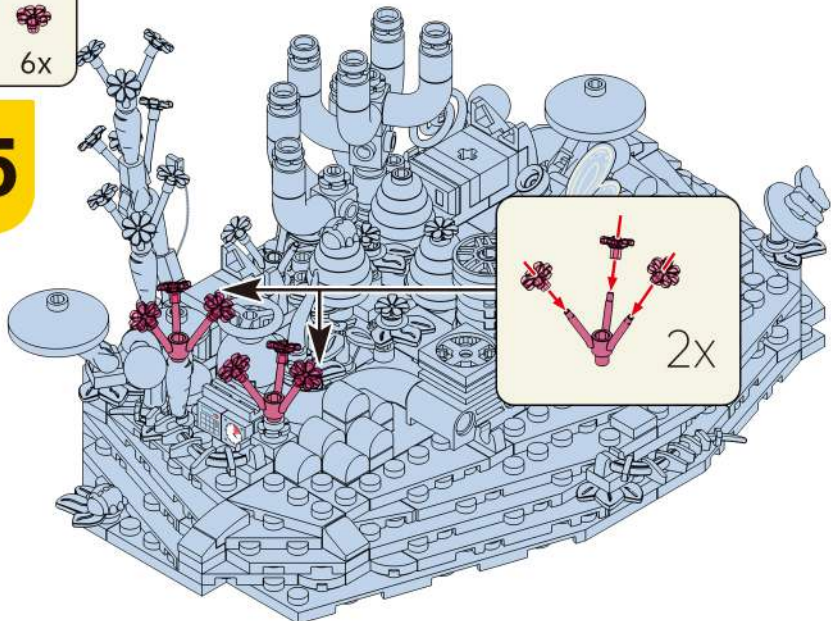

-  2x
-  6x

75



-  1x
-  1x
-  1x
-  1x
-  1x

76

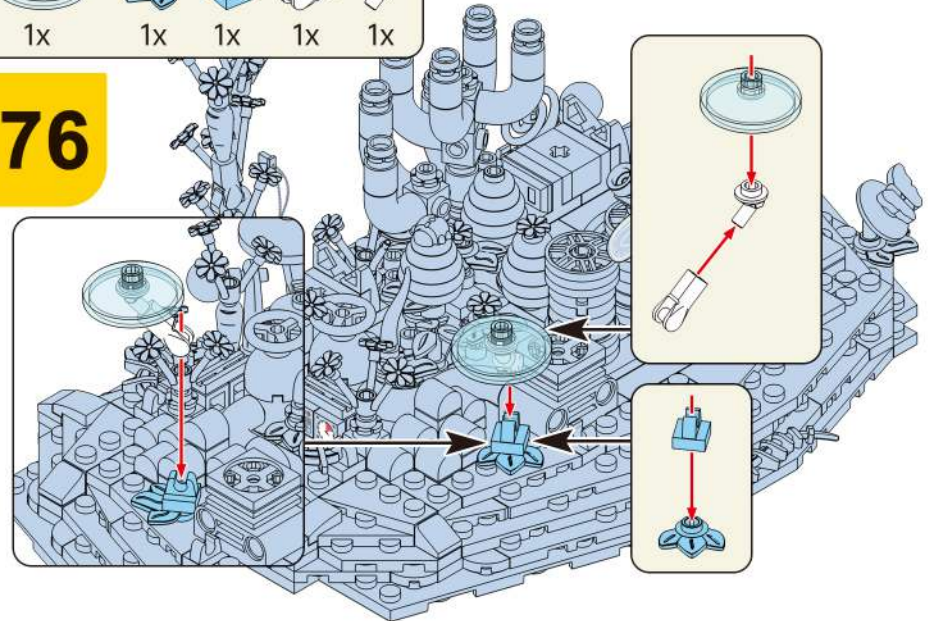

- 1x [Blue Technic Axle]
- 1x [Yellow Technic Pin]
- 1x [Blue Technic Pin]
- 1x [White Technic Pin]

77

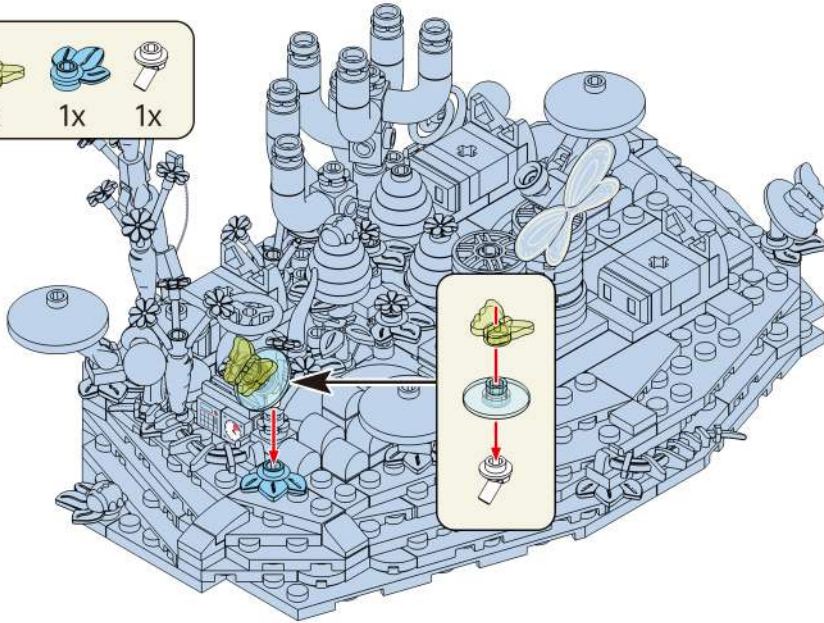

- 1x [Blue Technic Axle]
- 1x [Red Technic Pin]
- 1x [Blue Technic Pin]
- 1x [White Technic Pin]

78

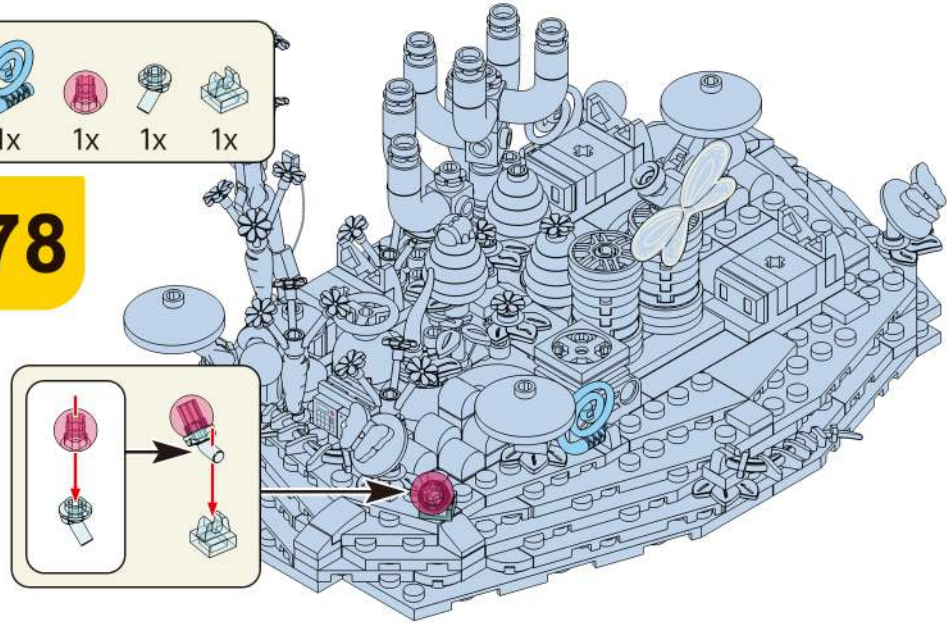

- 1x [Blue Technic Axle]
- 3x [Blue Technic Pin]
- 1x [Blue Technic Pin]
- 1x [Blue Technic Pin]

79

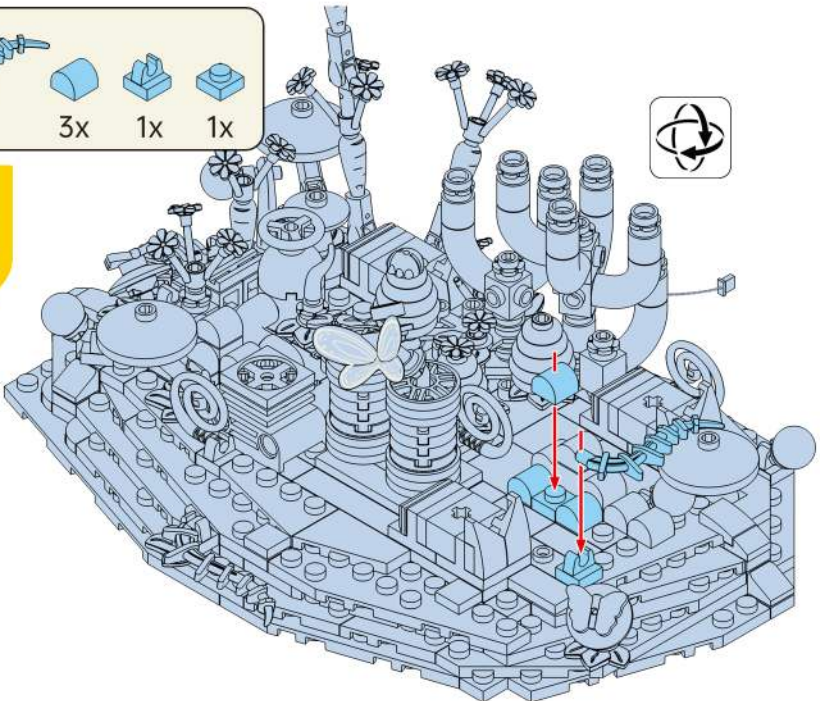

- 1x [Blue Technic Axle]
- 1x [Yellow Technic Pin]
- 1x [Blue Technic Pin]
- 1x [White Technic Pin]
- 1x [White Technic Pin]

80

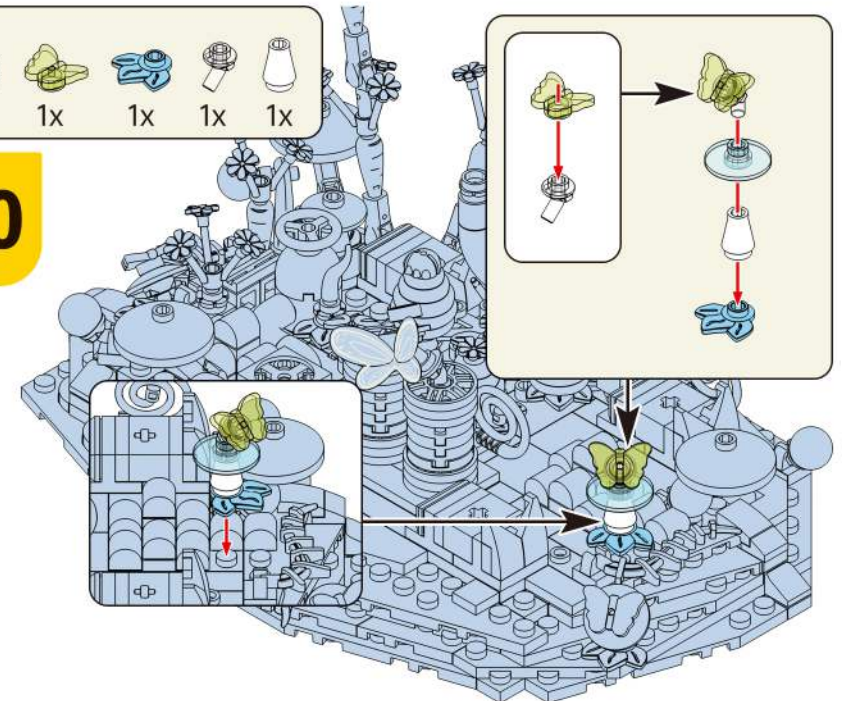

- 1x
- 1x
- 1x
- 3x

81

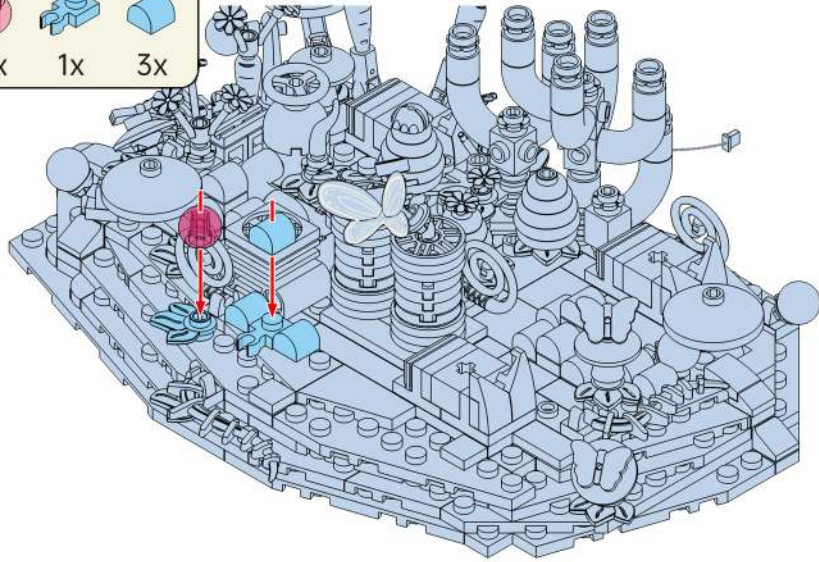

- 1x
- 1x
- 2x
- 1x

82

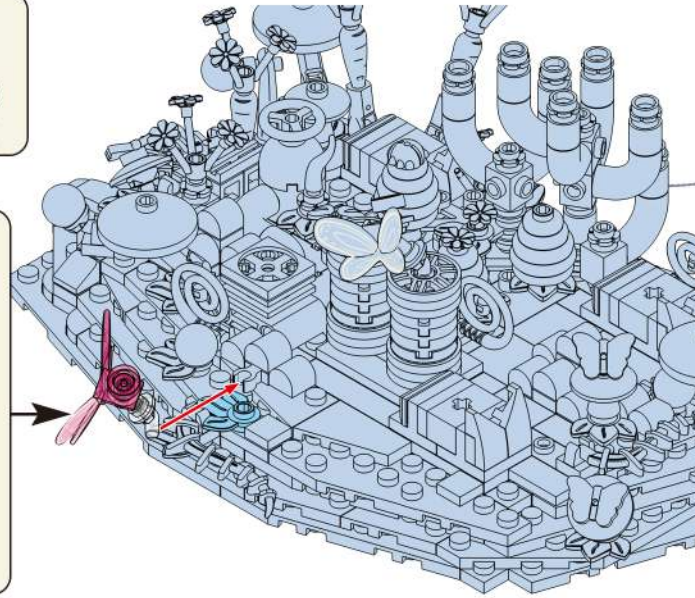
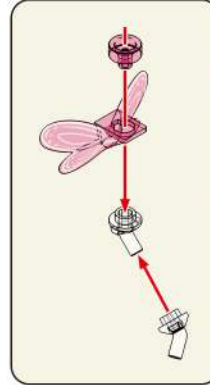

- 1x
- 1x
- 1x
- 1x

83

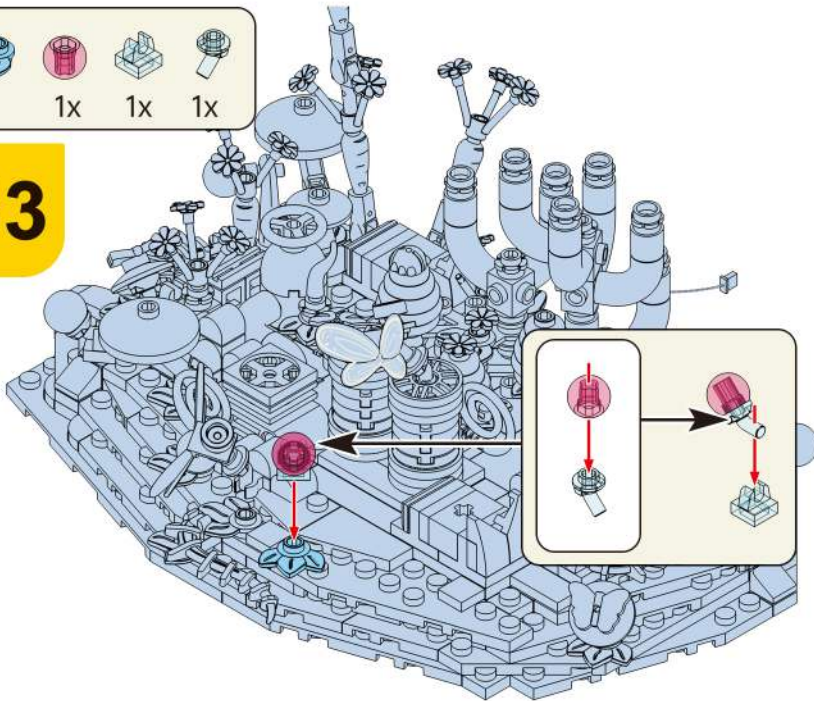

- 1x
- 1x
- 1x
- 1x

84

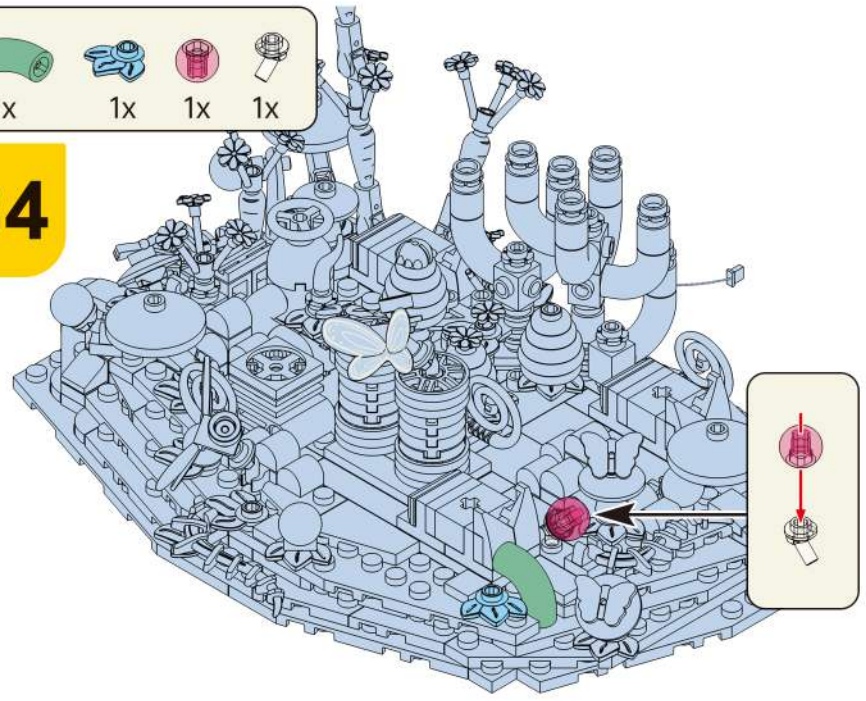

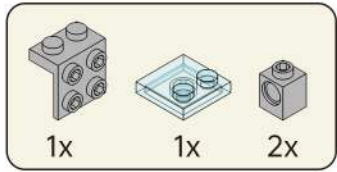

85

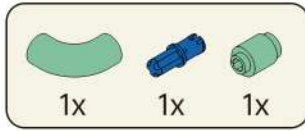
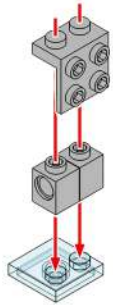

86

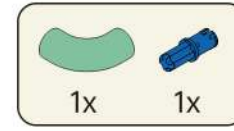
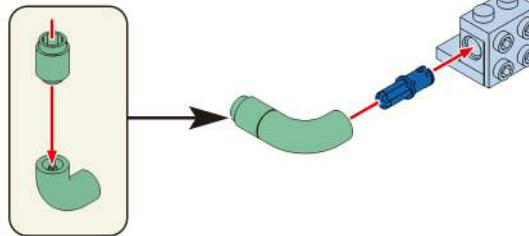

87

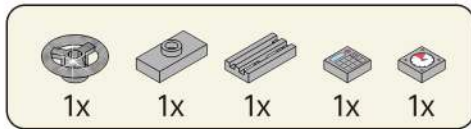
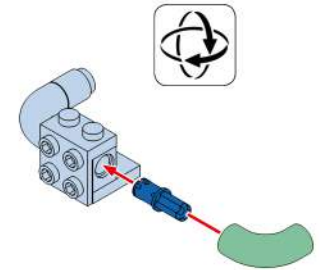

88

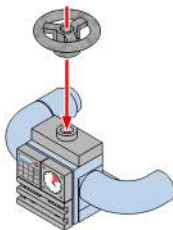

89

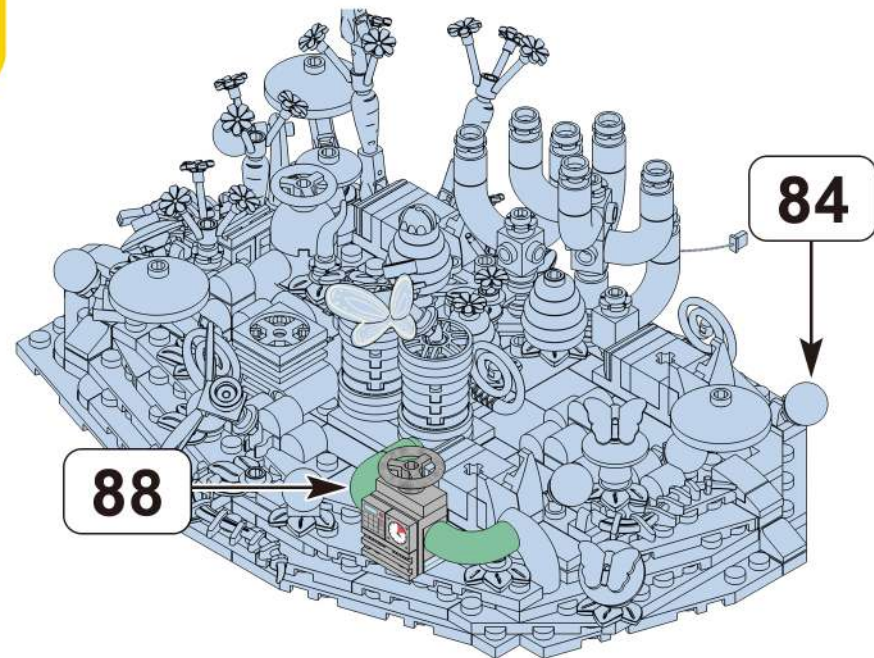

JOY MAKES BRILLIANCE.

Embrace Relaxation Embrace Joy

Every adultescent needs a "JOY BOX".
Please, open your JOY BOX! Heading for joy.

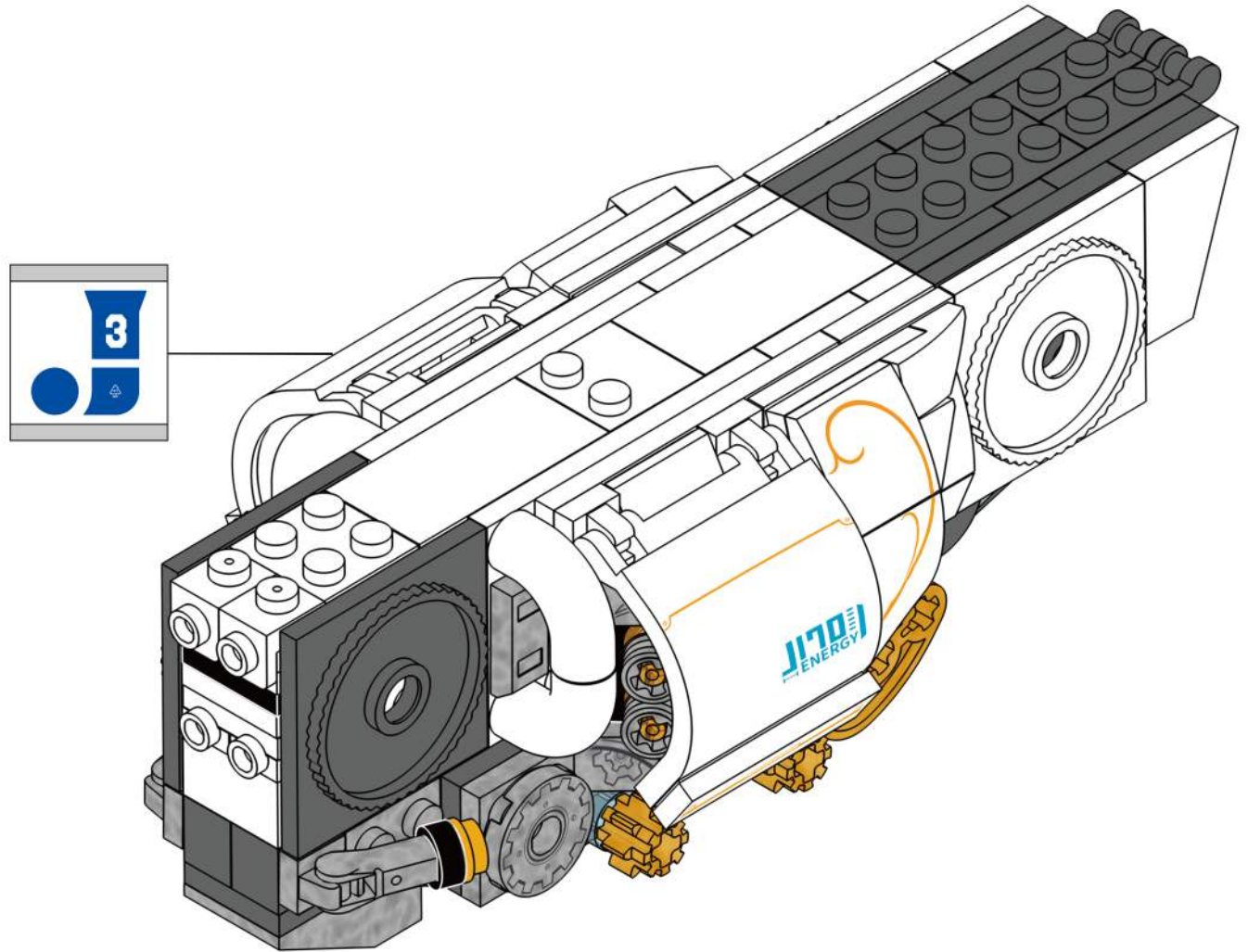

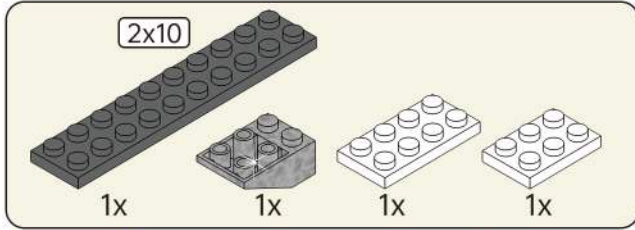

90

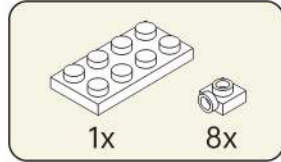
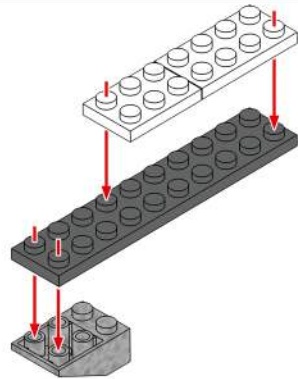

91

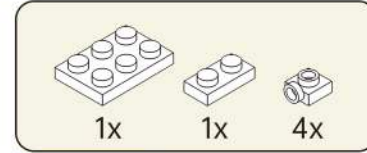
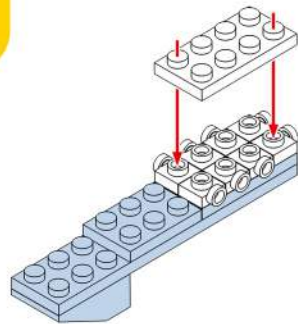

92

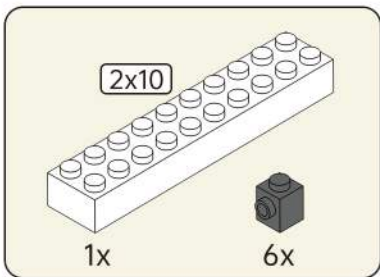
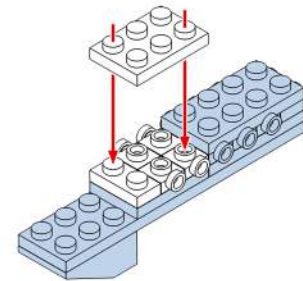

93

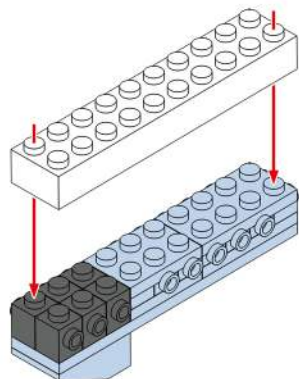

94

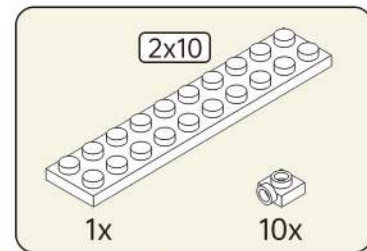
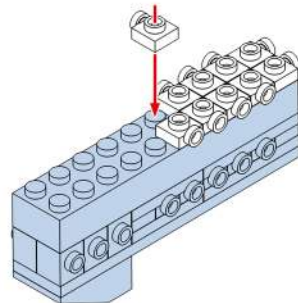

95

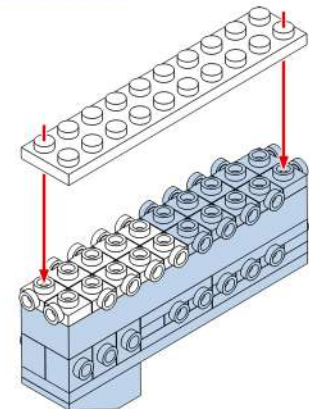

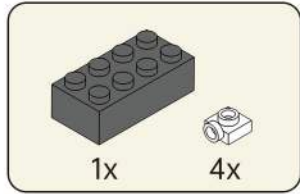

96

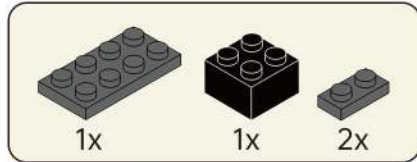
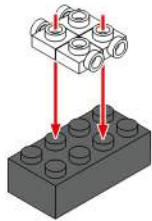

97

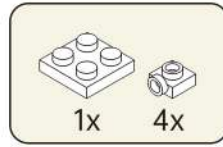
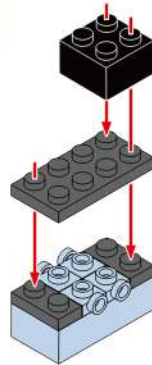

98

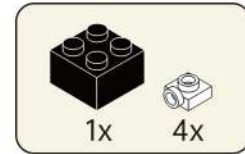
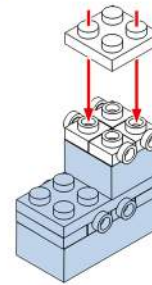

99

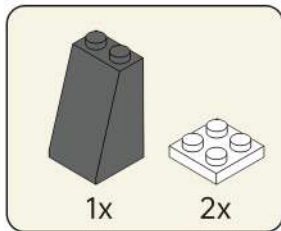
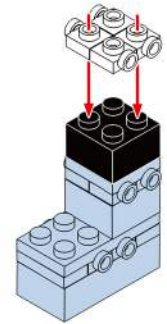

100

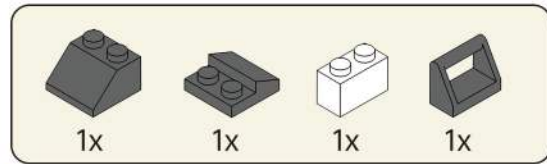
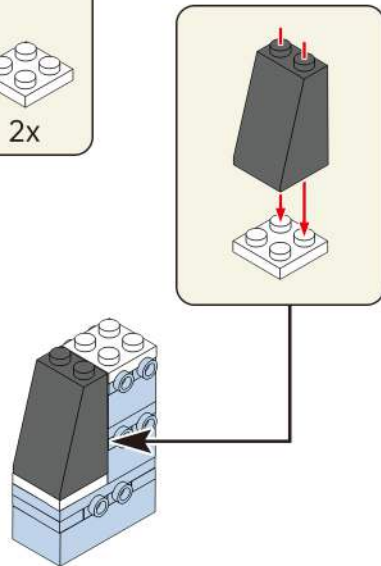

101

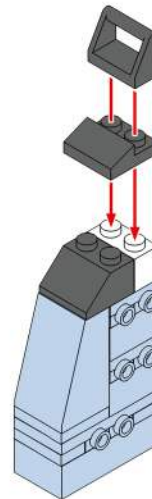

102

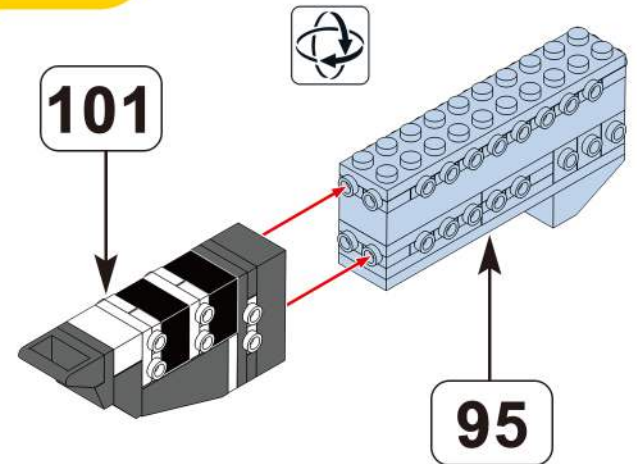

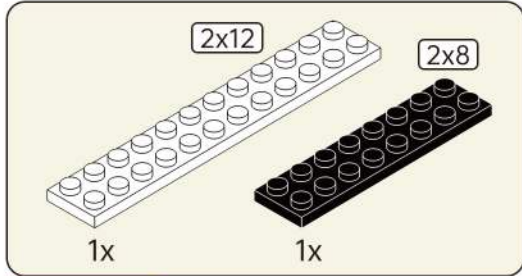

103

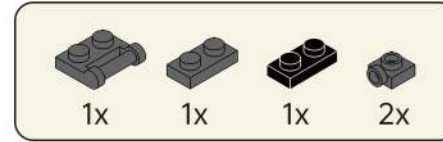
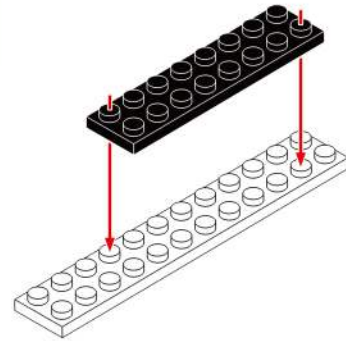

104

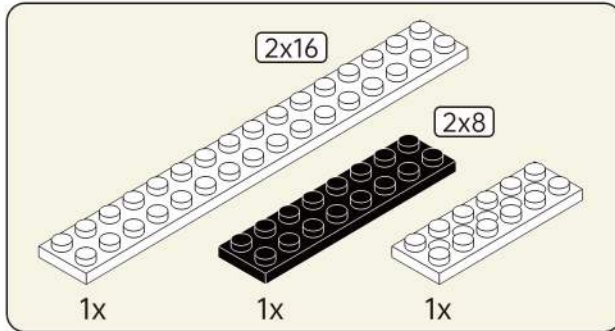
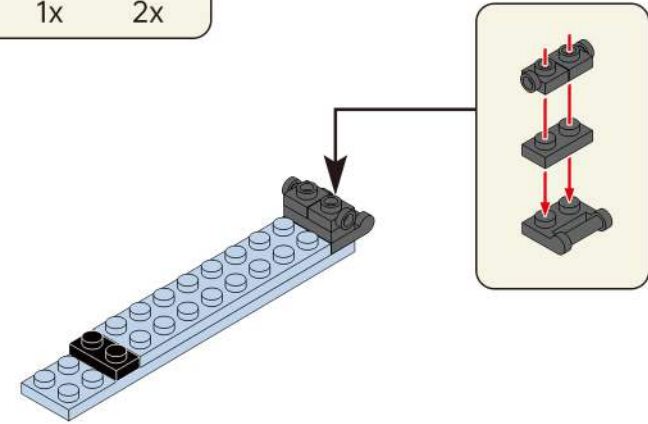

105

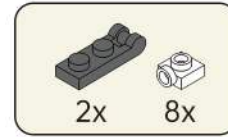
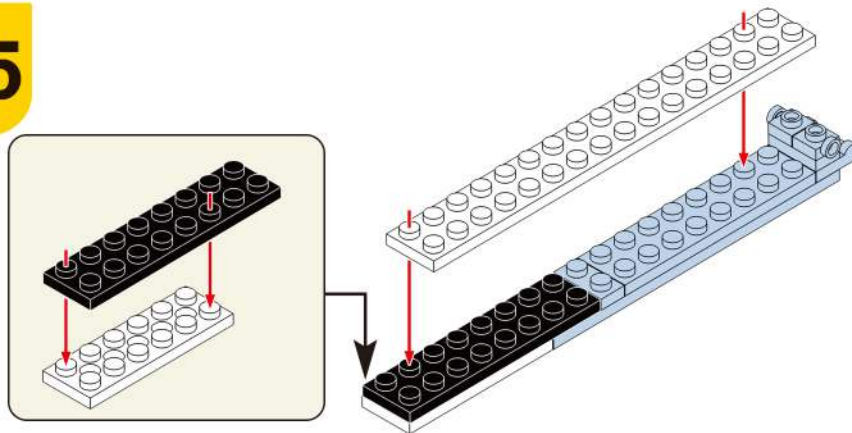

106

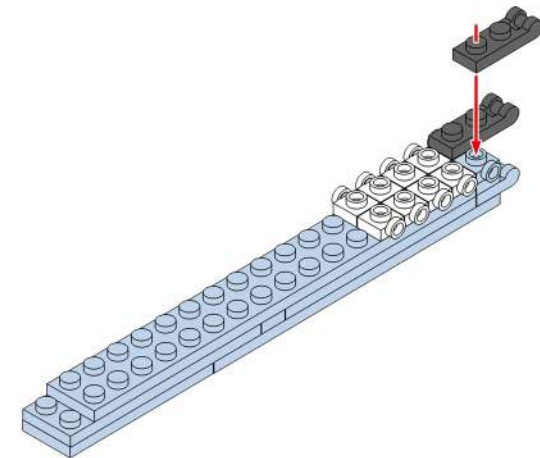

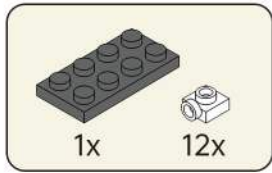

107

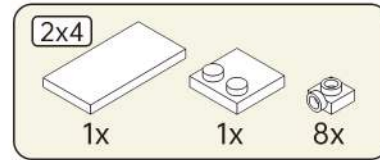
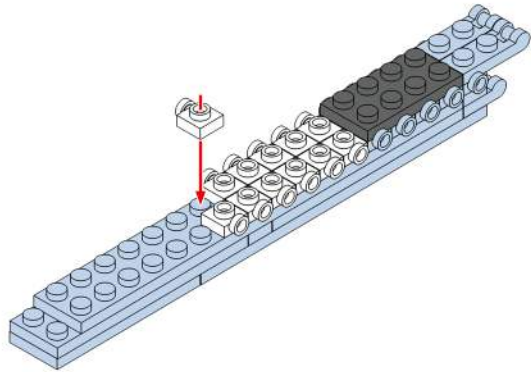

108

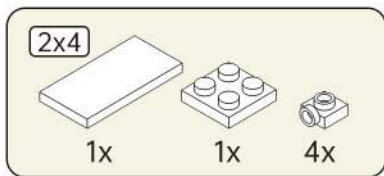
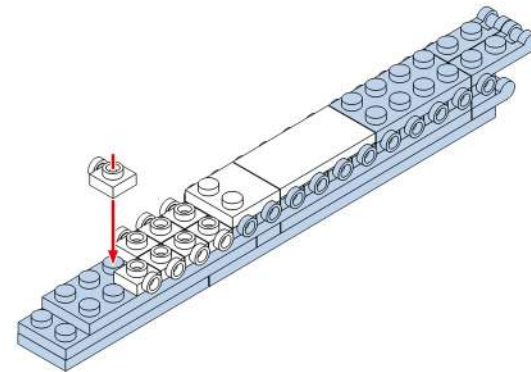

109

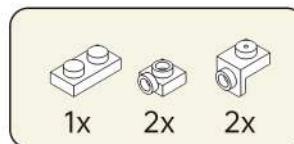
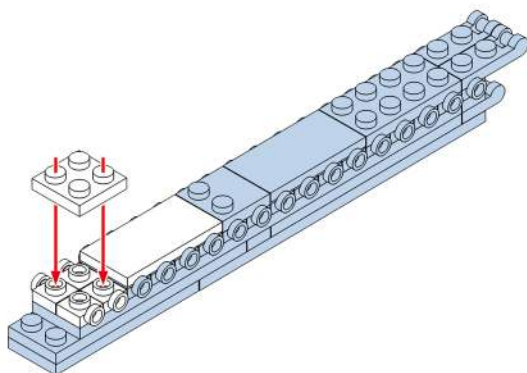

110

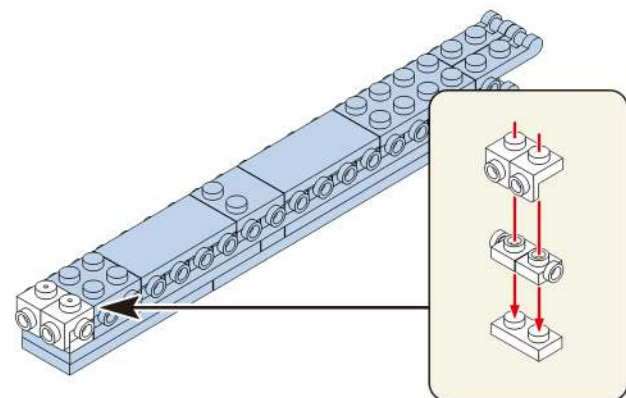

111



102

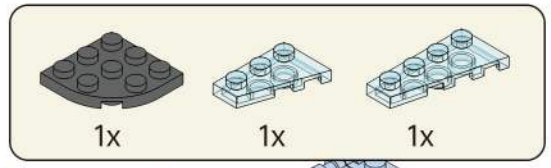
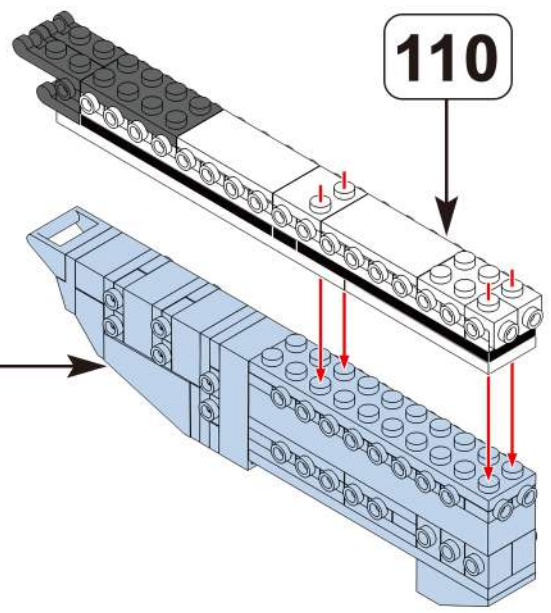

112

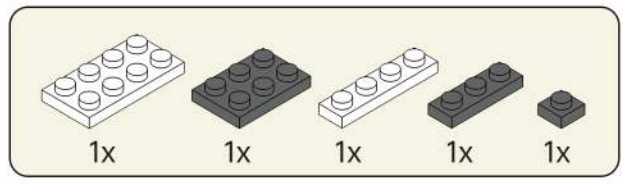
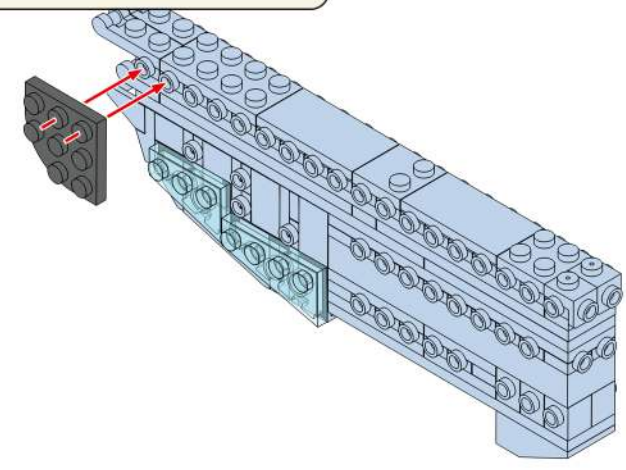

113

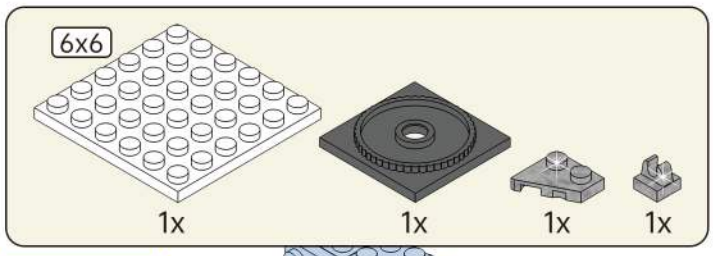
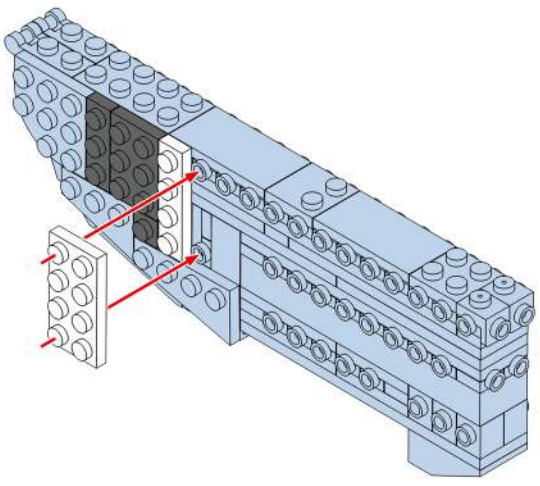

114

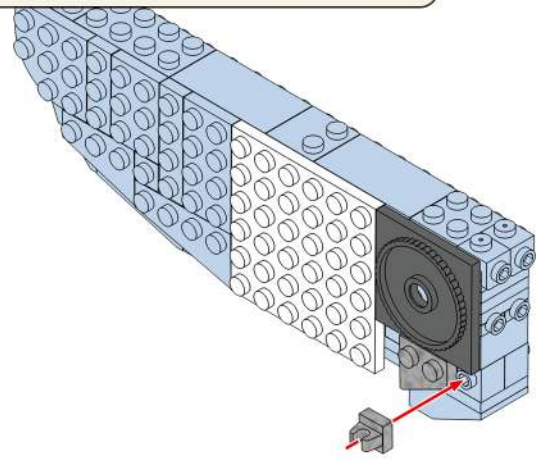

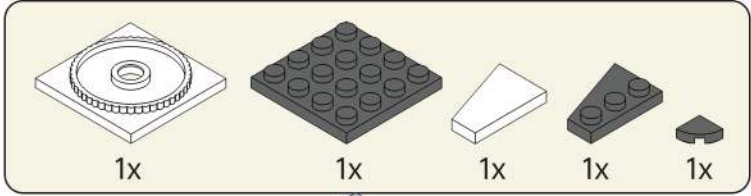

115

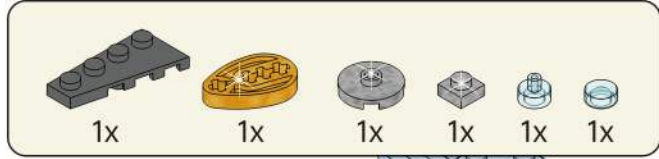
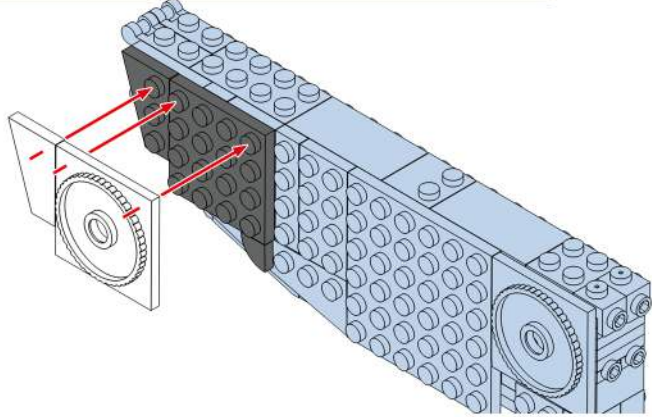

116

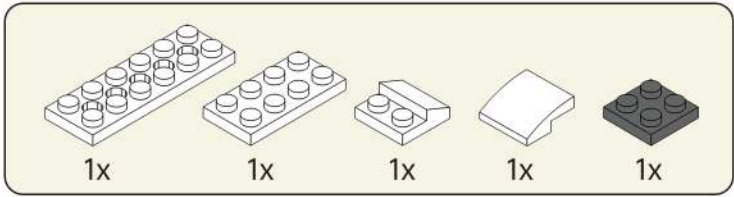
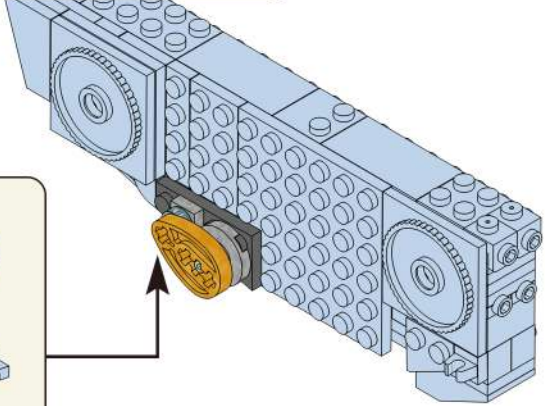
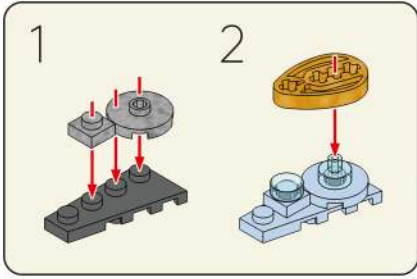

117

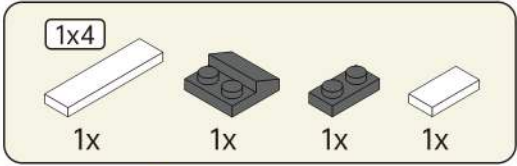
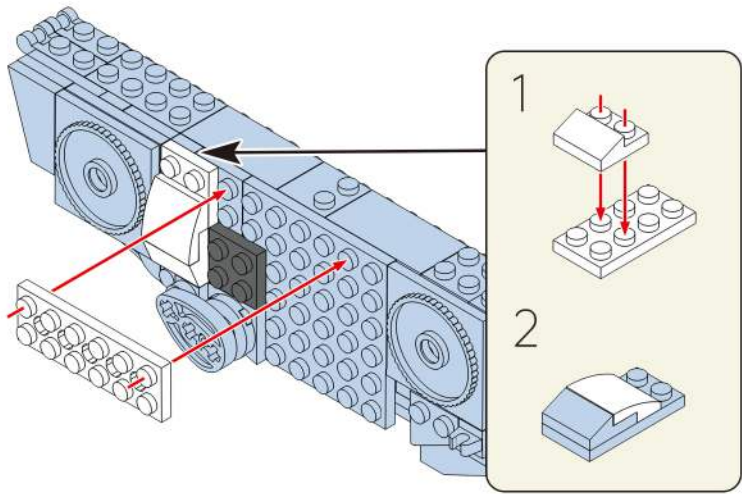

118

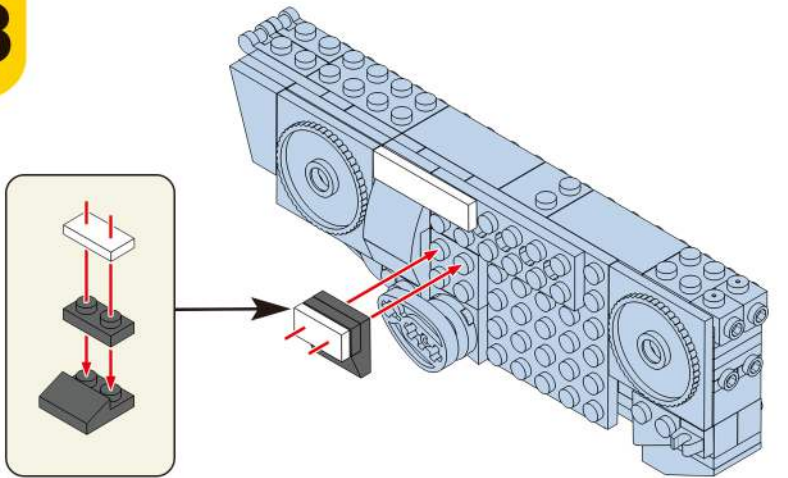

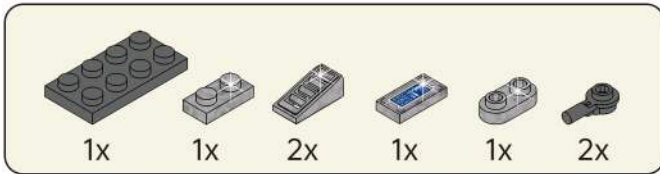

119

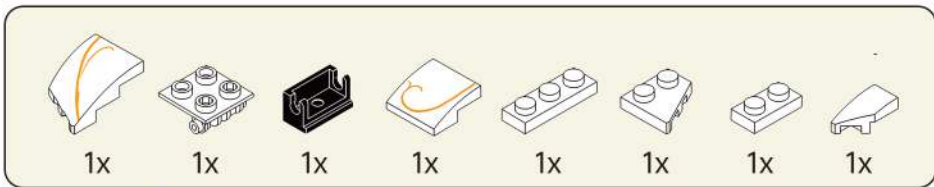
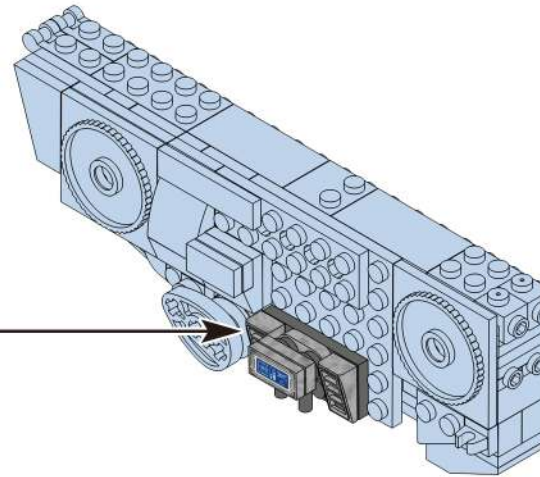
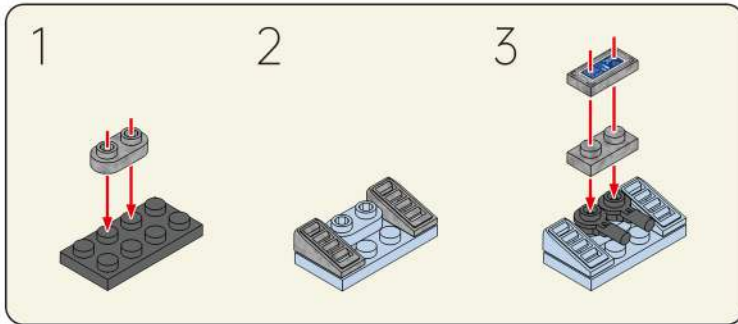



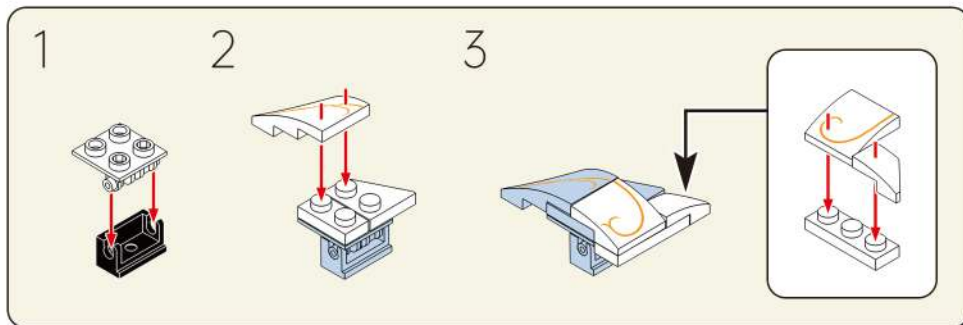



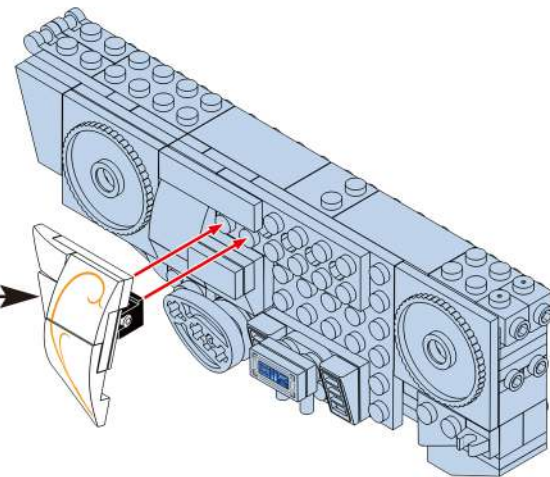

120



DIFFICULTY TIPS



The printing accessories for this step, as shown in the diagram, are assembled together and need to be disassembled before installation.

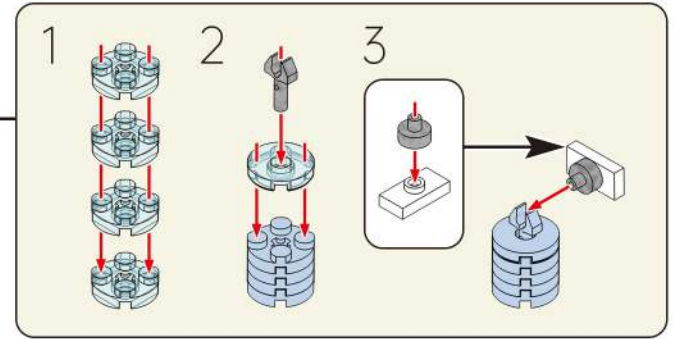
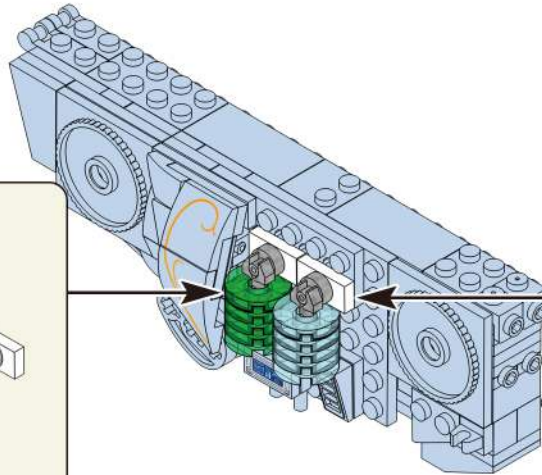
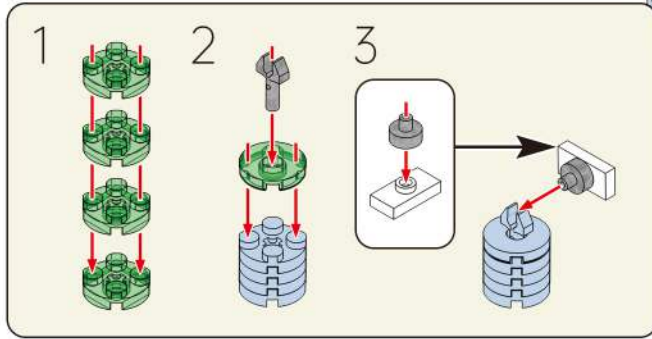

-  4x
-  1x
-  4x
-  1x
-  2x
-  2x
-  2x

121



-  1x
-  1x
-  2x

122

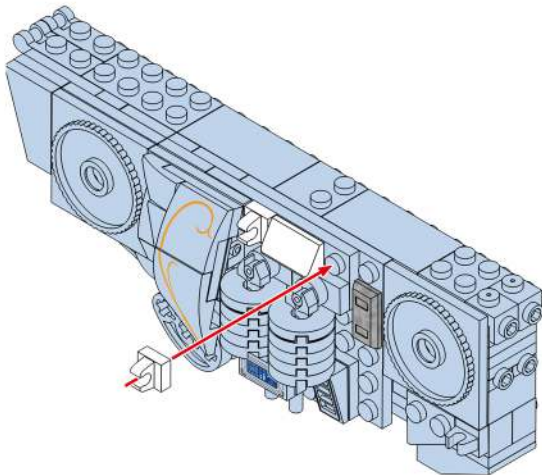

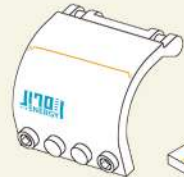
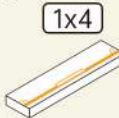
-  1x
-  1x4

123

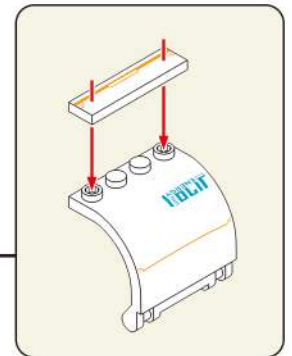
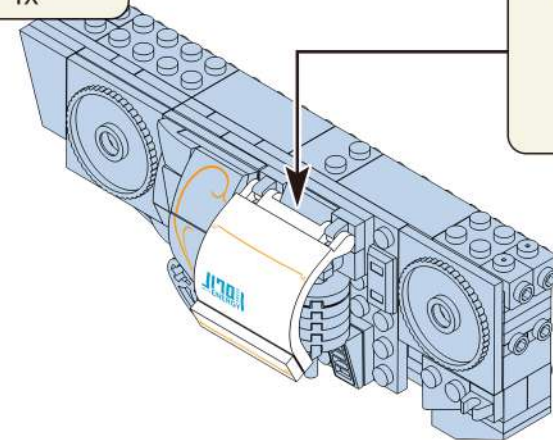

124

1x 1x 1x 1x 1x 1x

125

2x 1x

126

1x 1x 1x 1x

127

1x 1x 1x 1x

- 2x
- 2x
- 2x

131

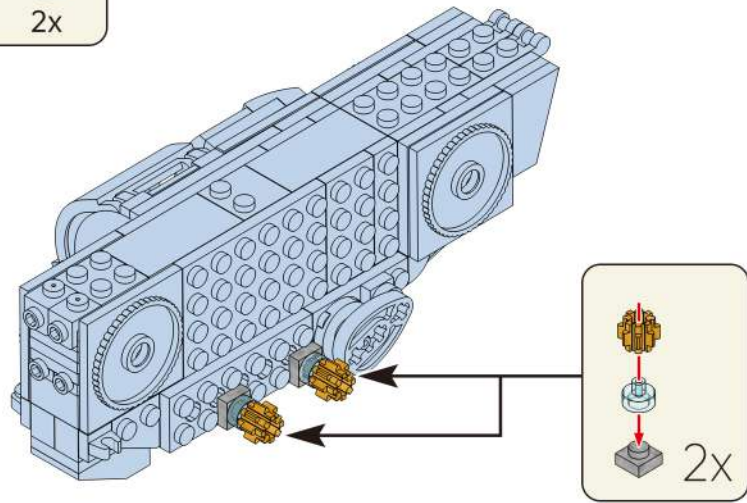

- 1x
- 1x
- 1x
- 2x

132

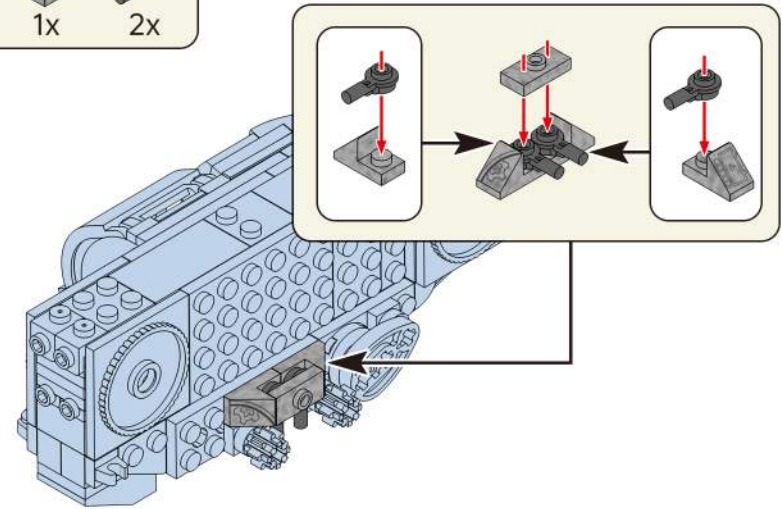

- 1x
- 1x
- 1x
- 1x
- 1x

133

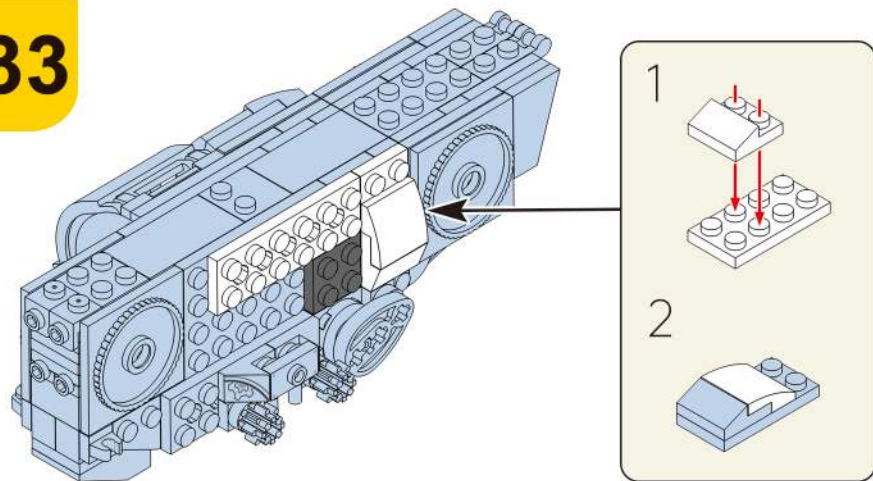

- 1x4
- 1x
- 1x
- 1x

134

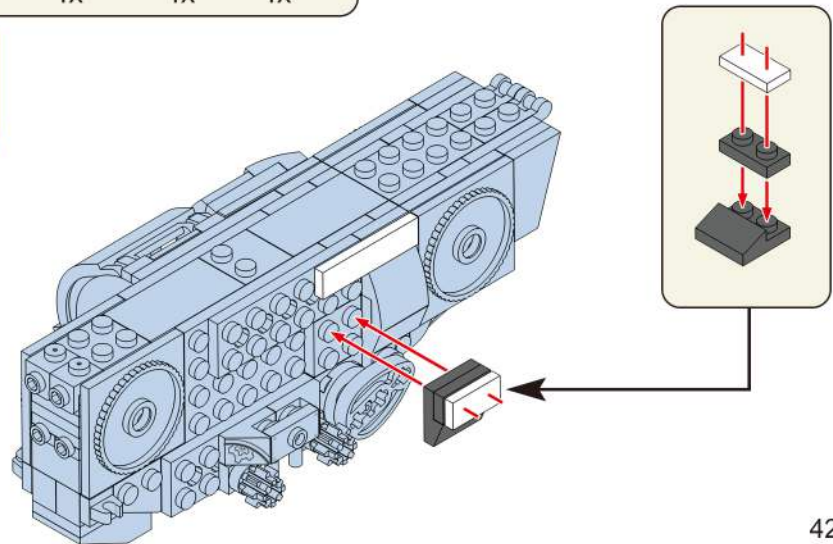

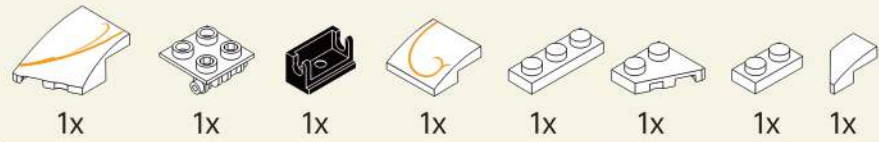

The printing accessories for this step, as shown in the diagram, are assembled together and need to be disassembled before installation.

135

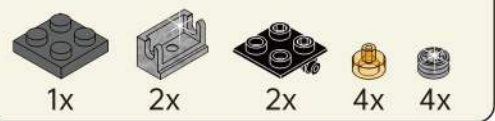
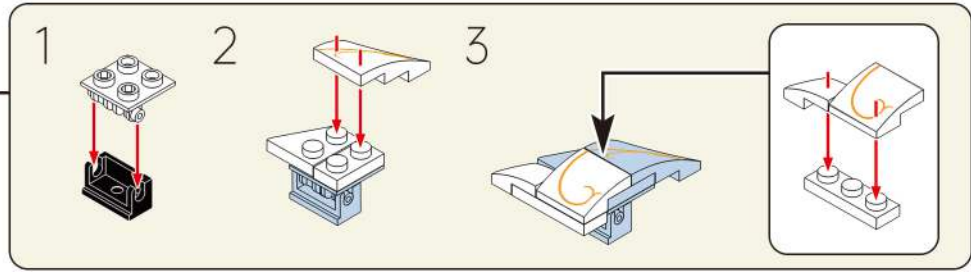
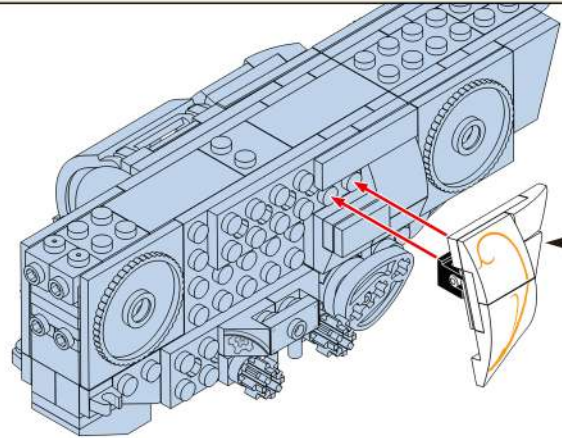

136

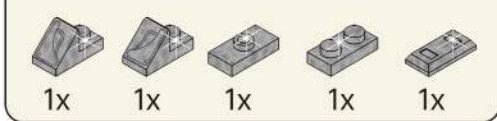
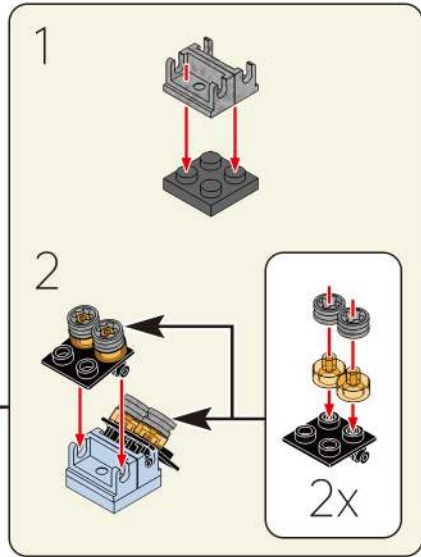
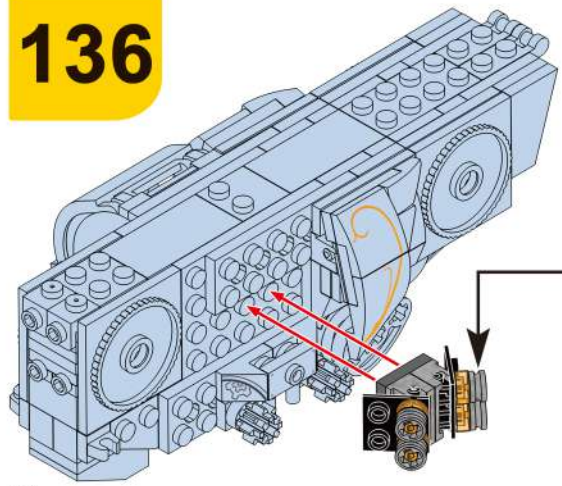

137

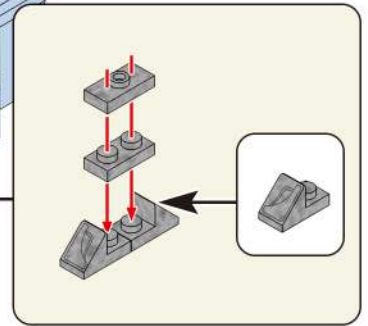
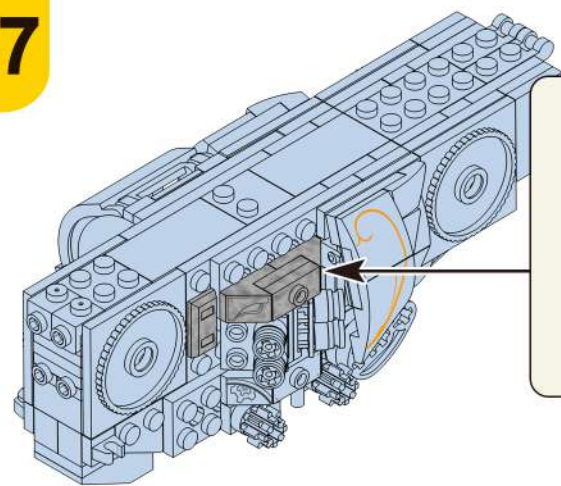

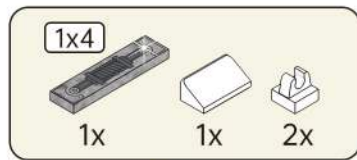

138

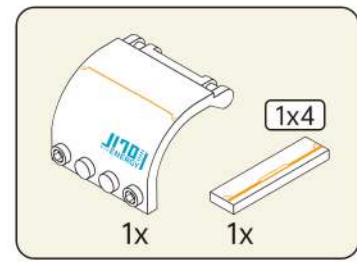
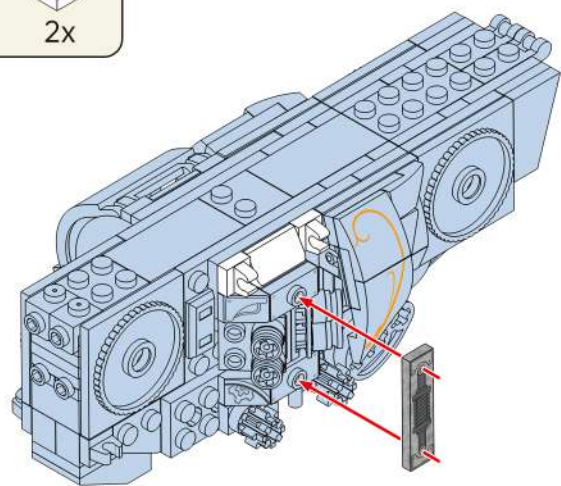

139

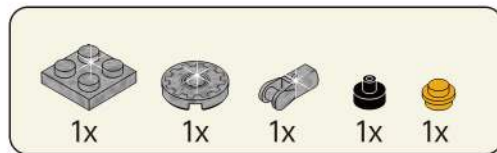
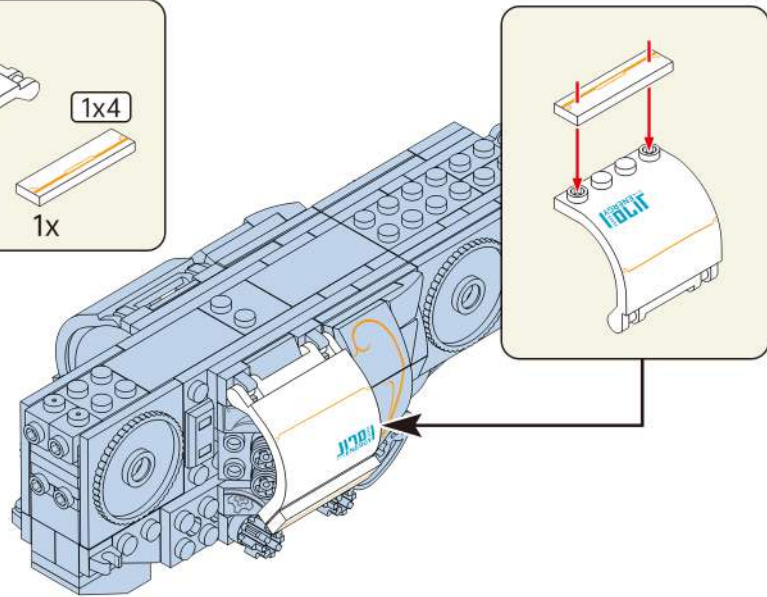

140

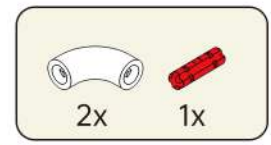
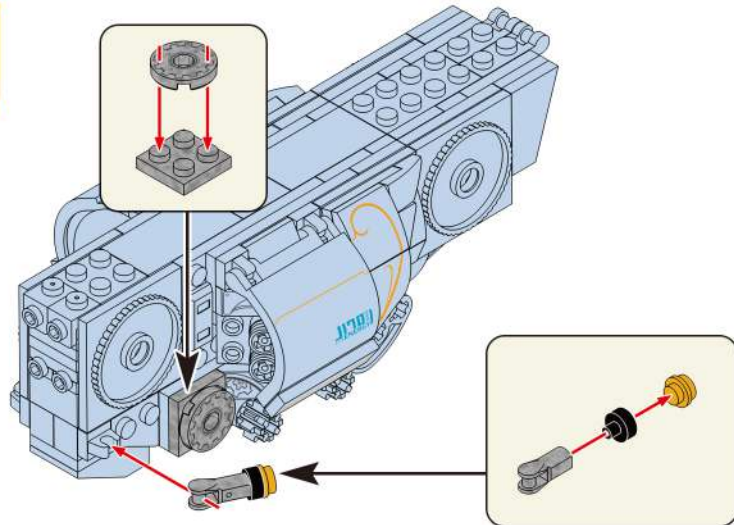

141

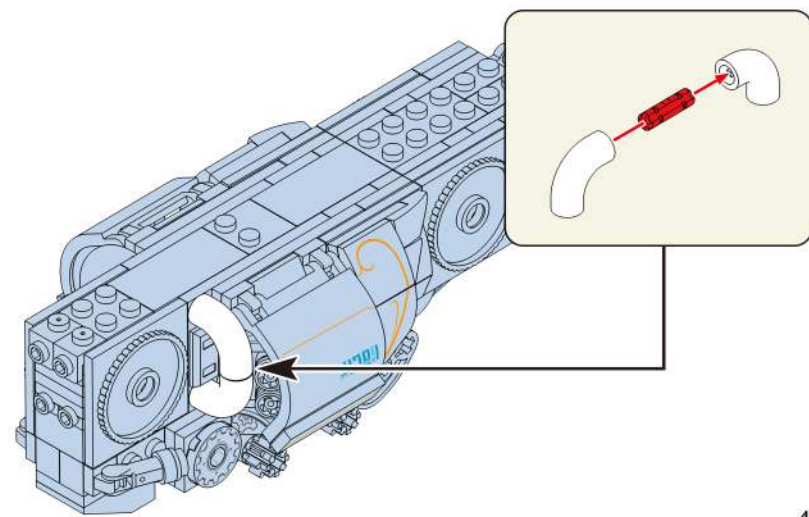

JOY MAKES BRILLIANCE.

Embrace Relaxation Embrace Joy

Every adultescent needs a "JOY BOX".
Please, open your JOY BOX ! Heading for joy.

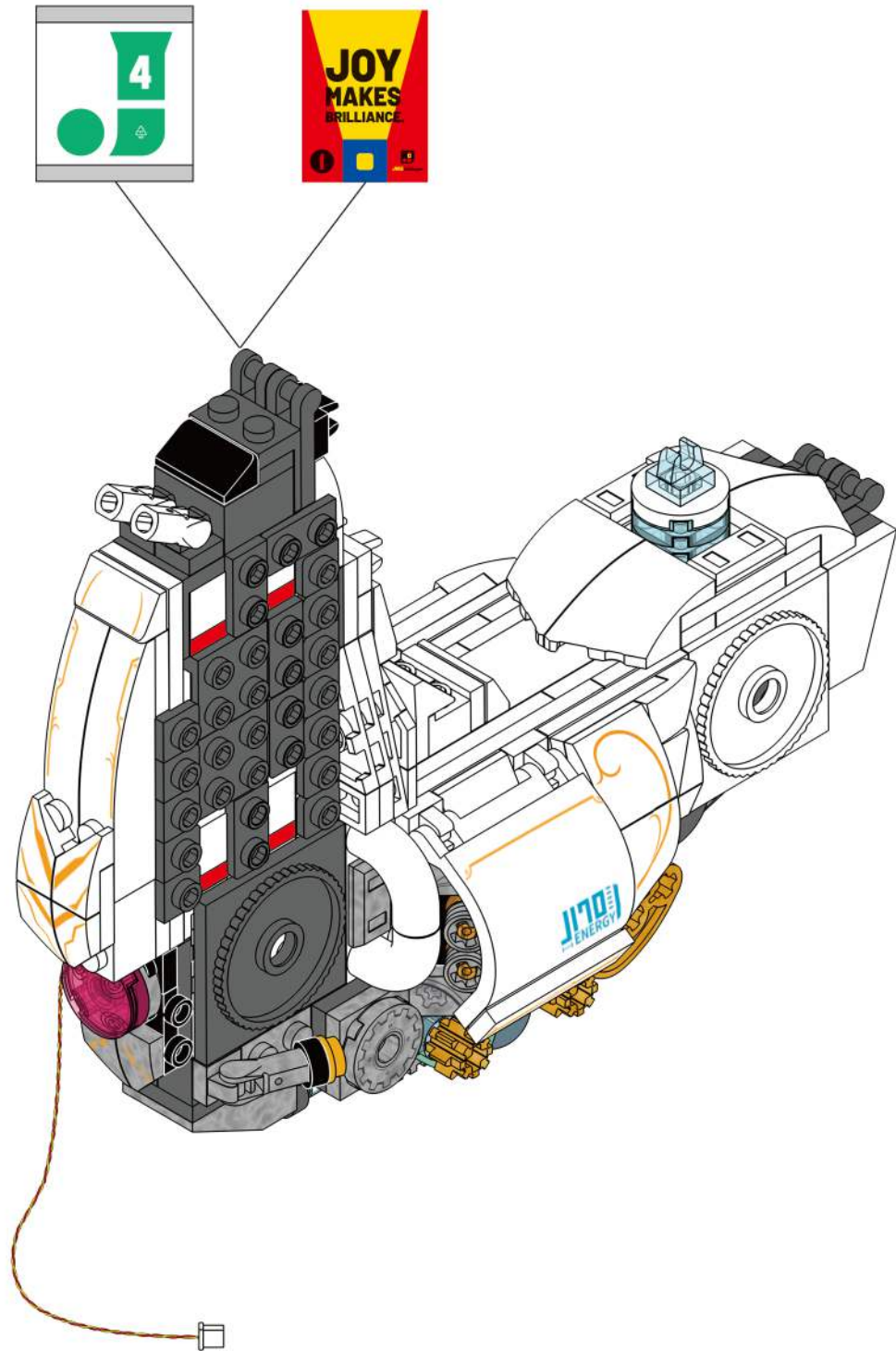

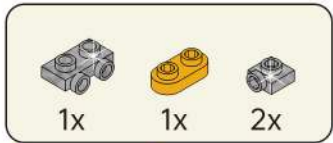

142

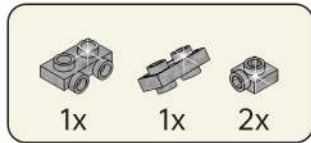
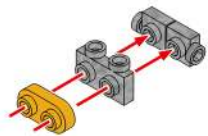

143

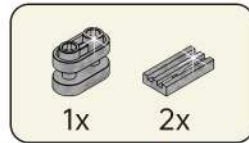
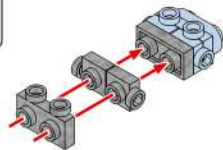

144

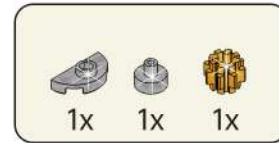
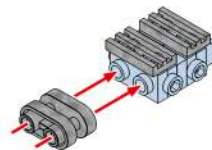

145

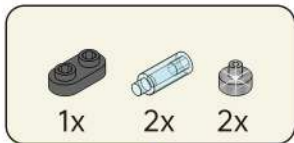
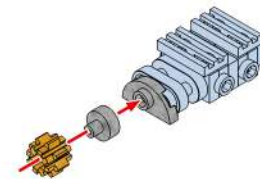

146

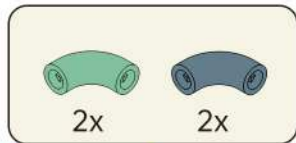
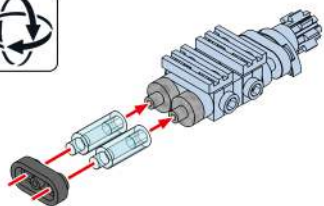

147

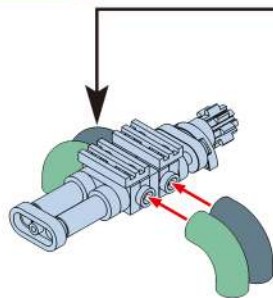
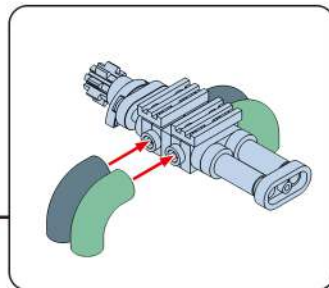

148

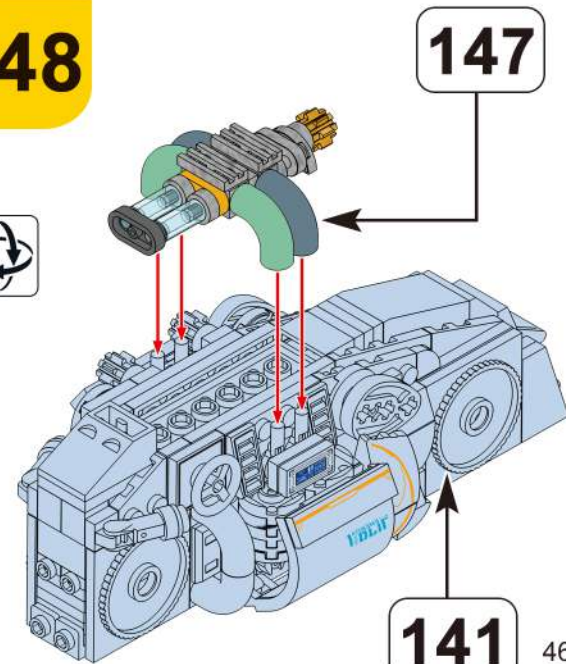

141

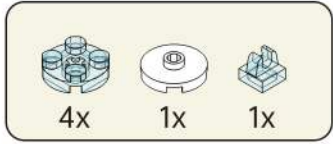

149

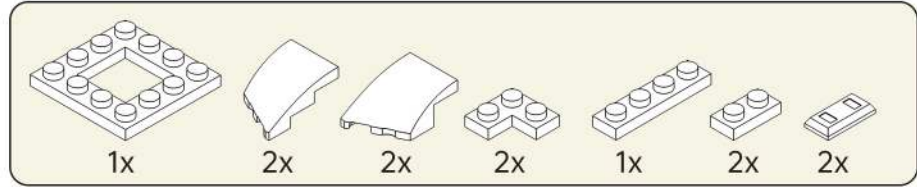
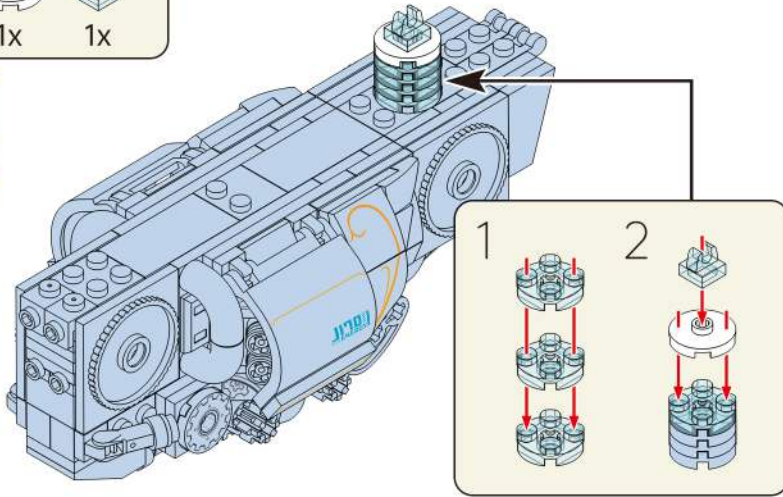

150

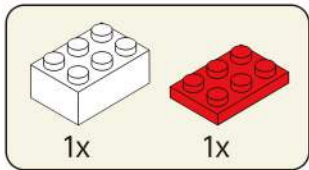
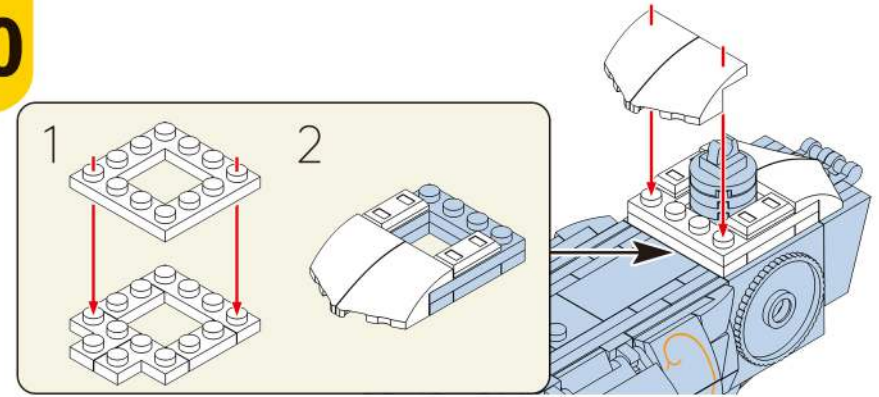

151

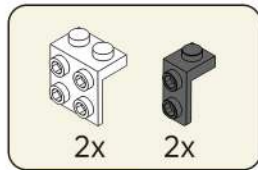
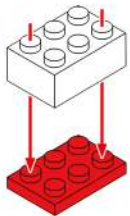

152

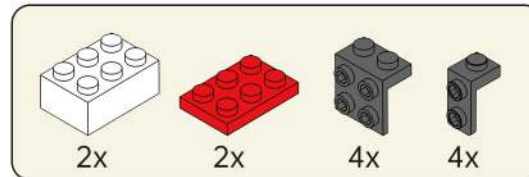
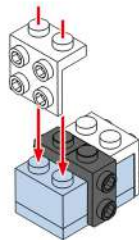

153

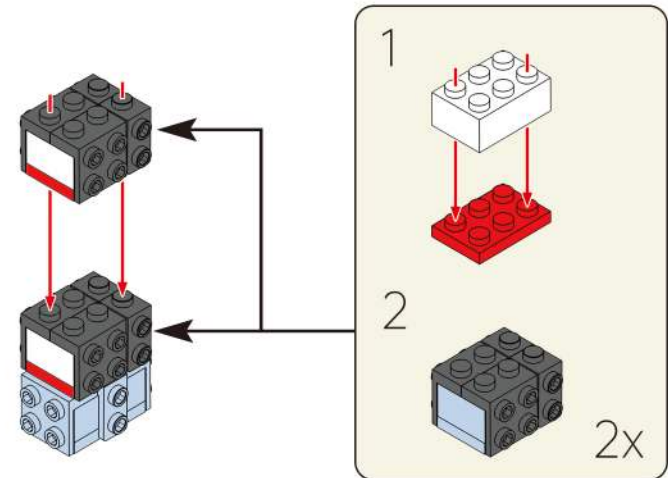

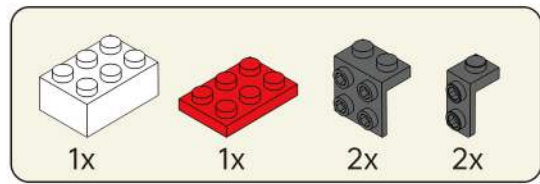

154

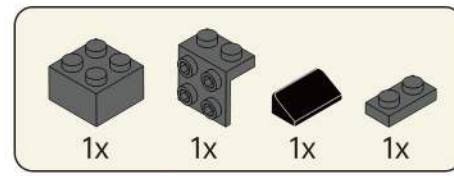
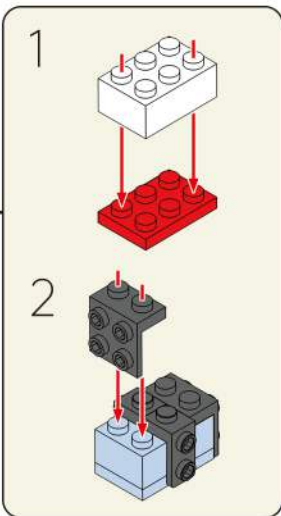

155

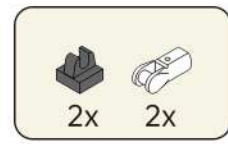
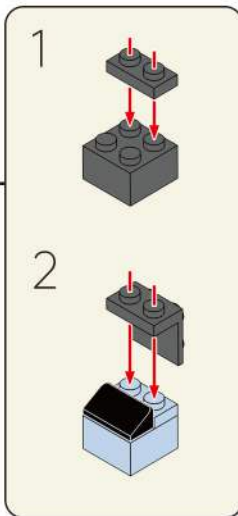

156

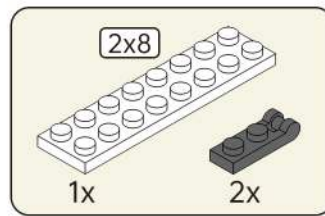
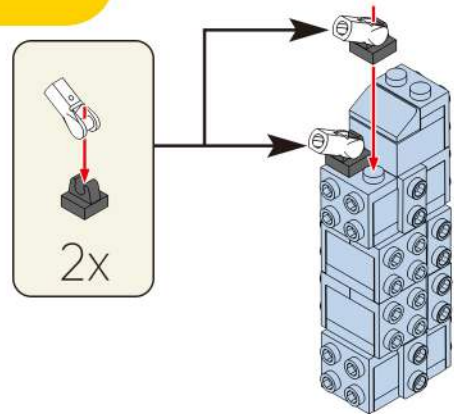

157

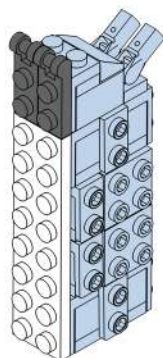

158

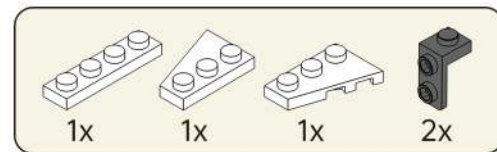
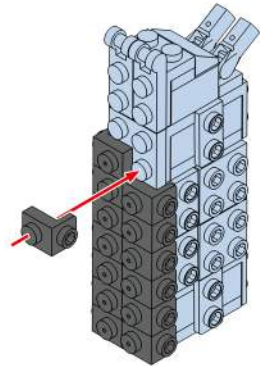

159

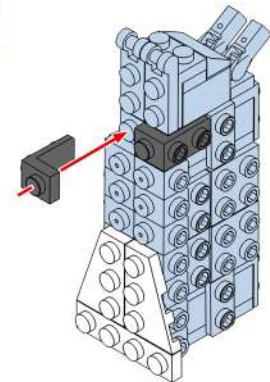

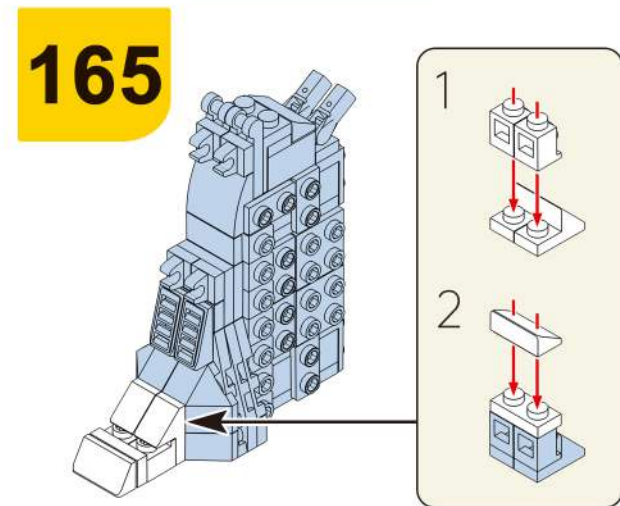
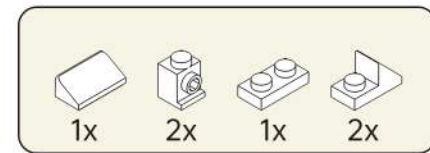
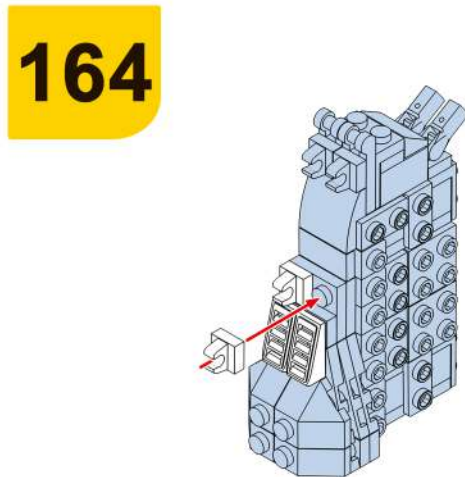
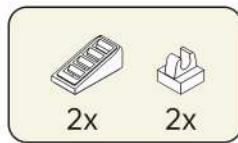
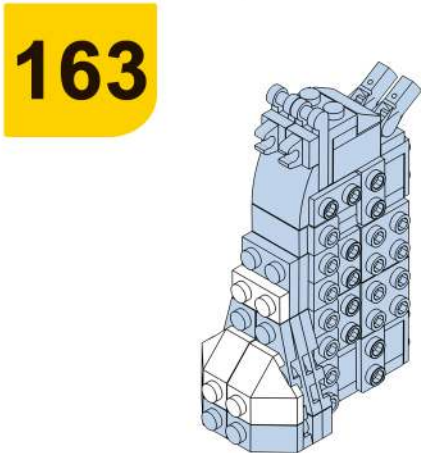
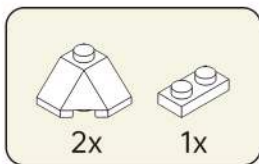
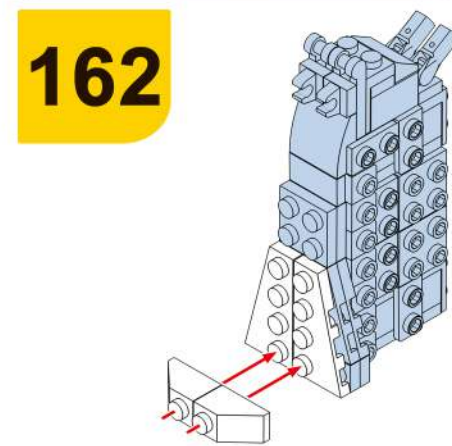
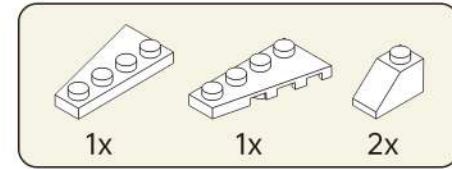
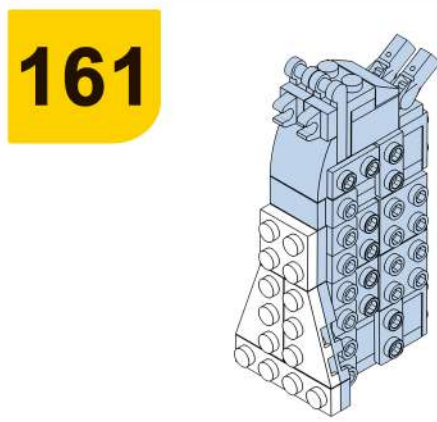
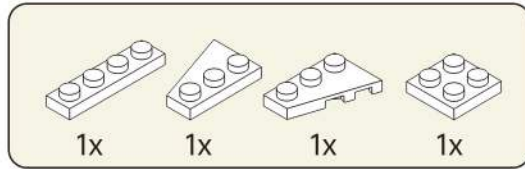
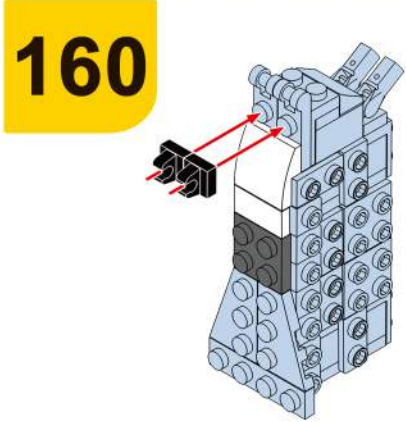
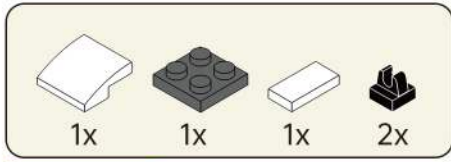

166

165

150

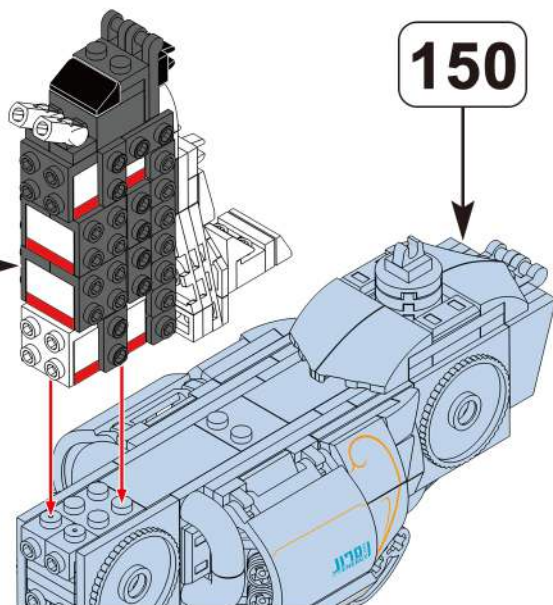

1x

2x

1x

167

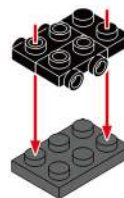

1x

1x

1x

168

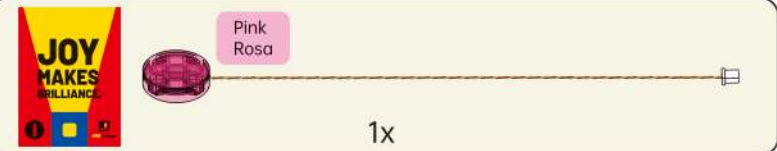
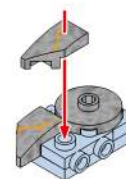

1x

169

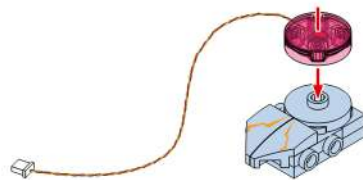

170

169

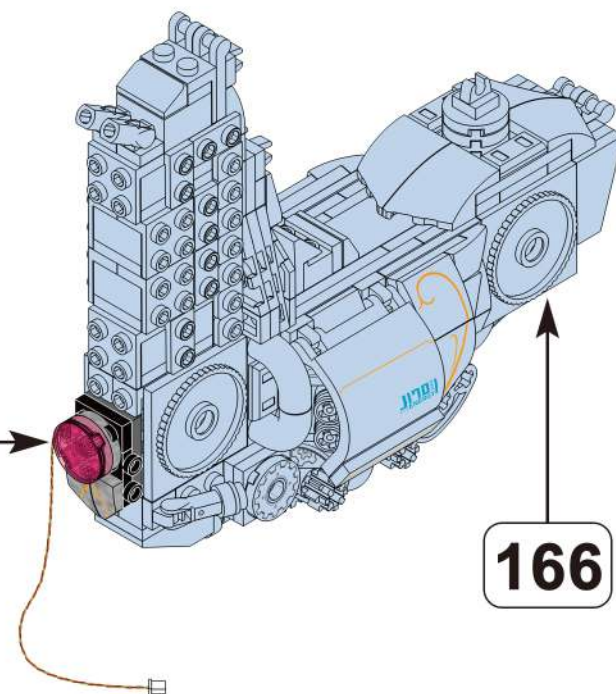

166

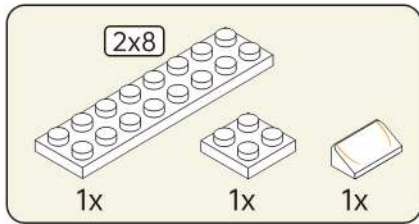

171

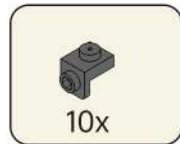
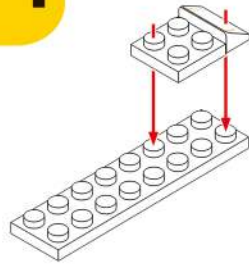

172

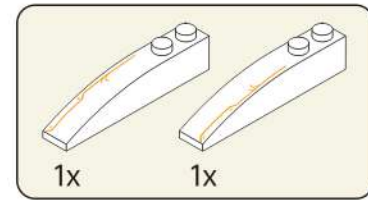
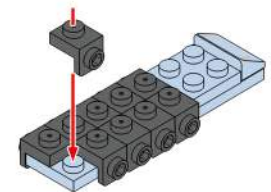

173

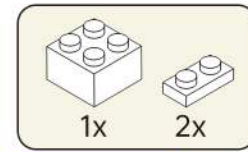
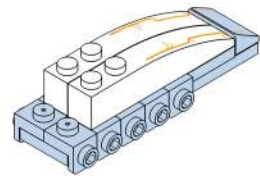

174

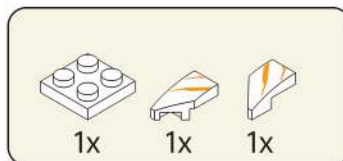
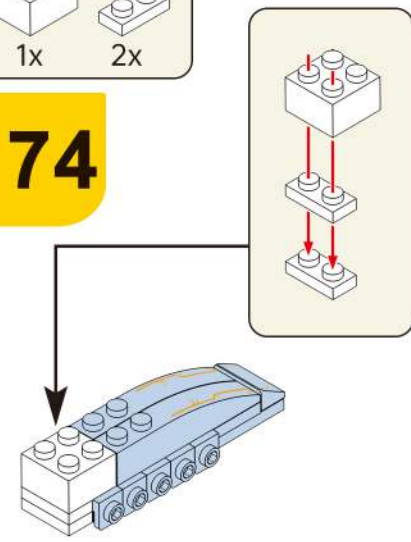

175

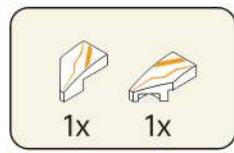
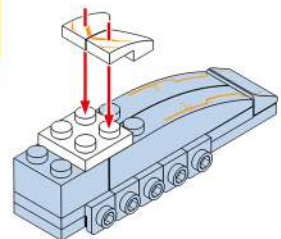

176

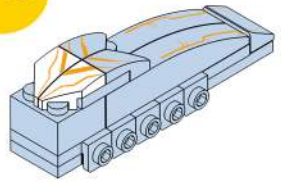

177

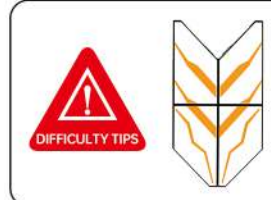
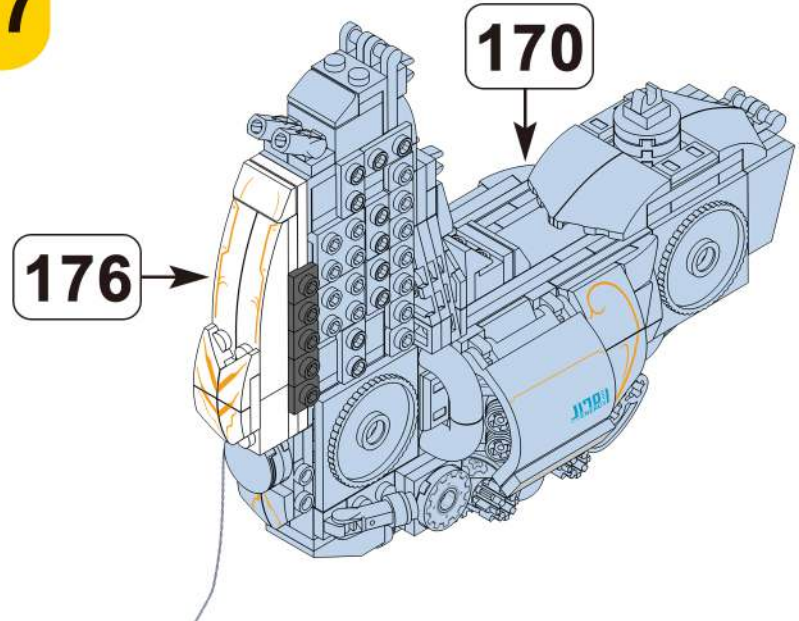

The printing accessories for this step, as shown in the diagram, are assembled together and need to be disassembled before installation.

JOY MAKES BRILLIANCE.

Embrace Relaxation Embrace Joy

Every adultescent needs a "JOY BOX".
Please, open your JOY BOX! Heading for joy.

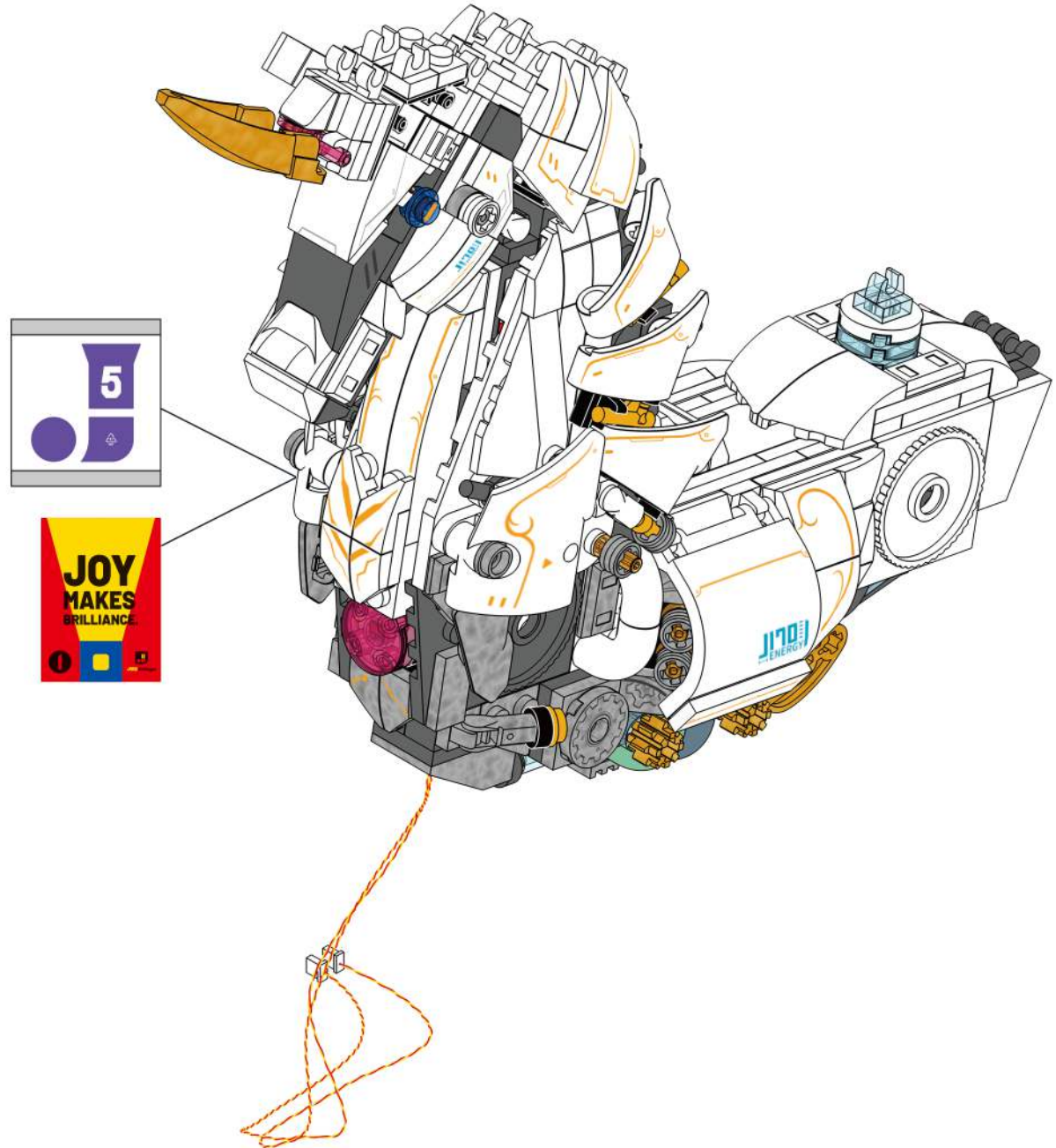

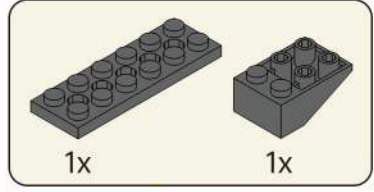

178

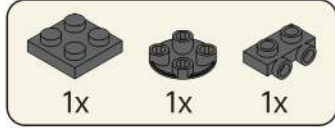
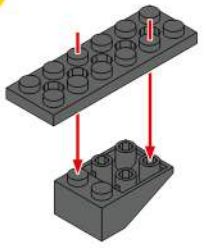

179

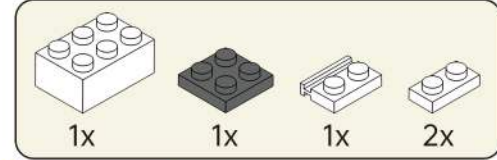
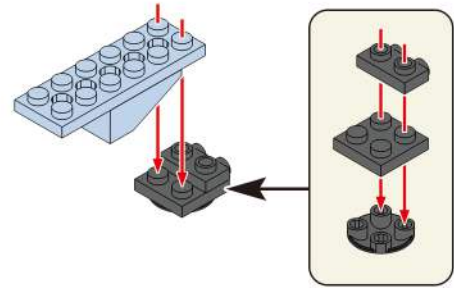

180

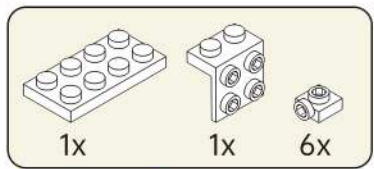
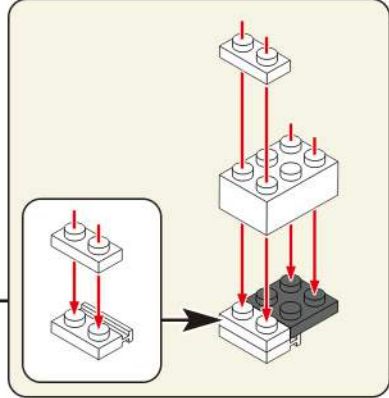
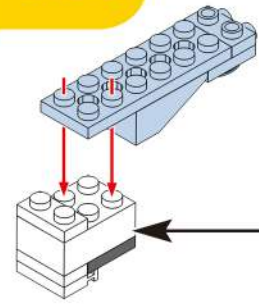

181

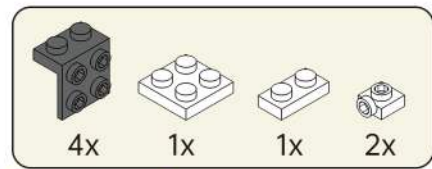
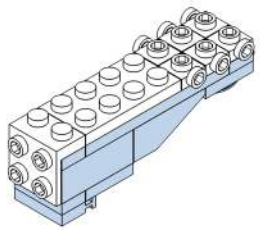

182

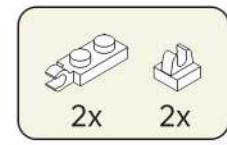
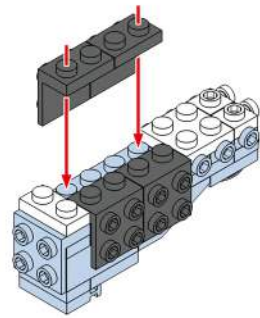

183

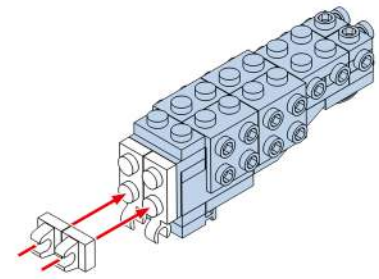

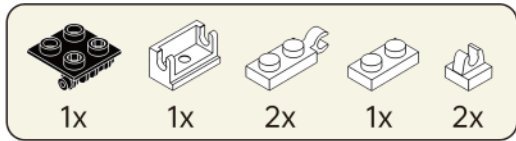

184

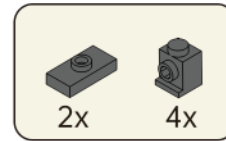
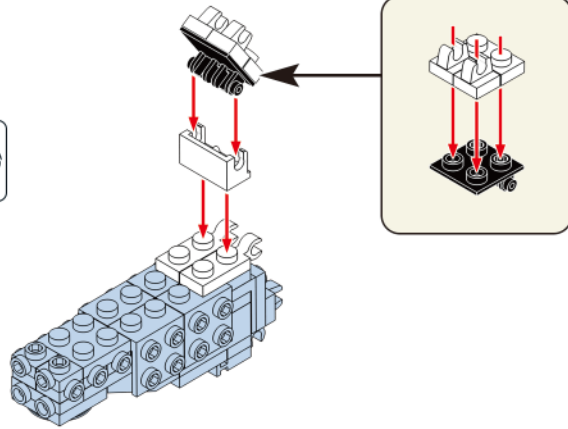

185

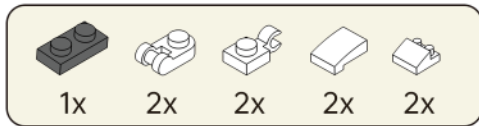
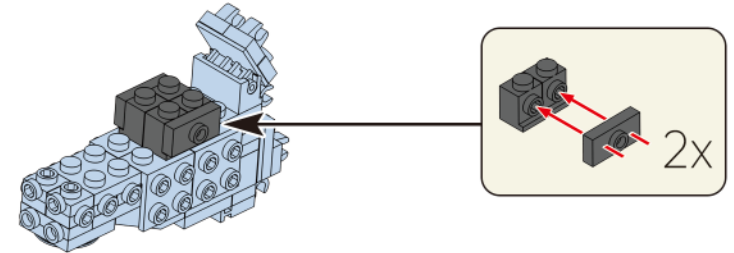

186

The product contains special parts, please pay attention when assembling!

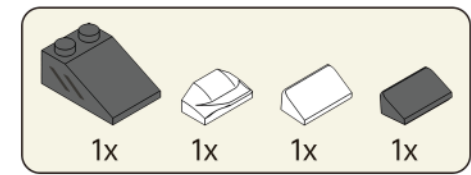
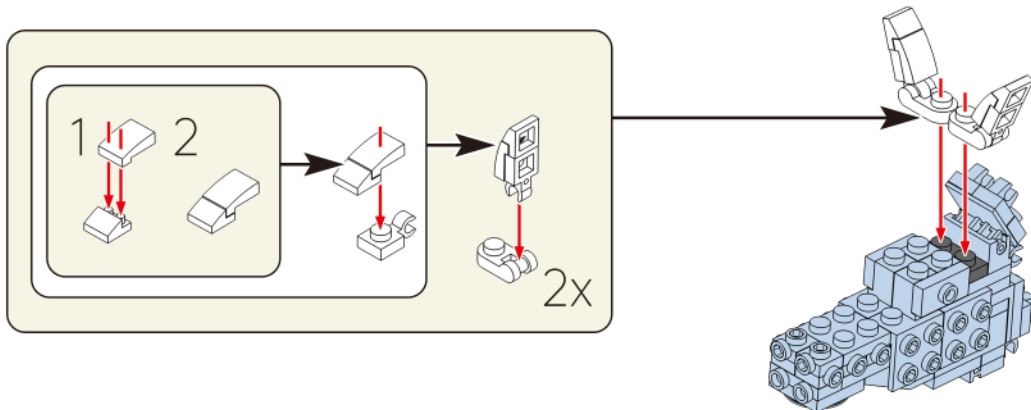

187

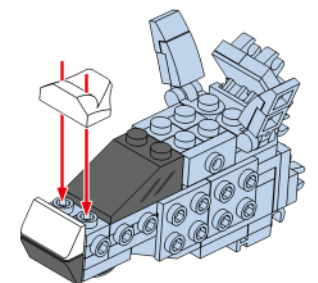

JOY MAKES BRILLIANCE

Blue Blau

Blue Blau

1x

1x

1x

1x

188

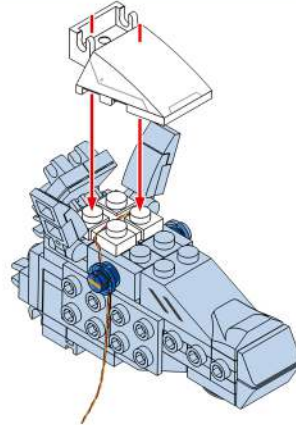

1x

1x

1x

1x

1x

189

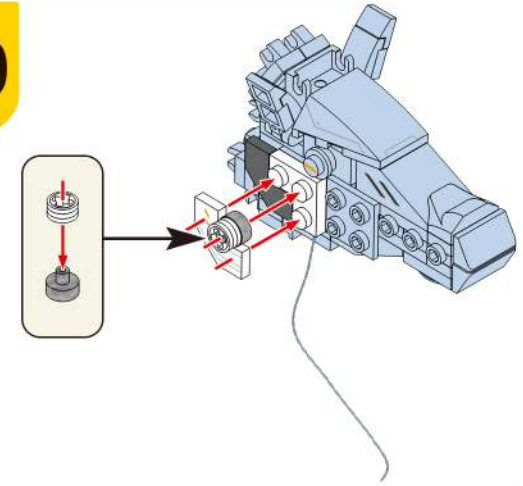

1x

1x

1x

190

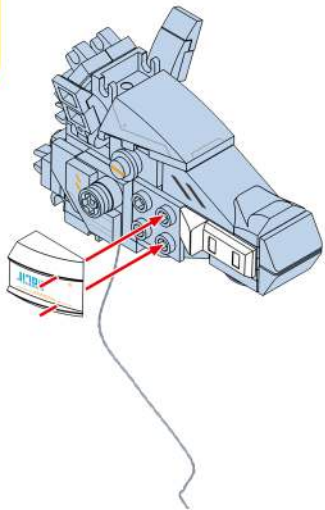

1x

1x

1x

1x

1x

191

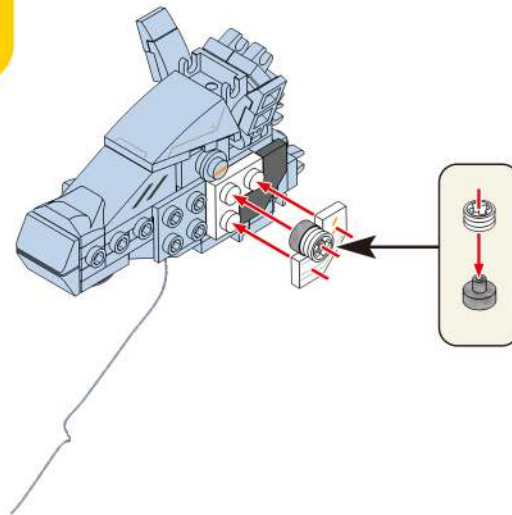

1x

1x

1x

192

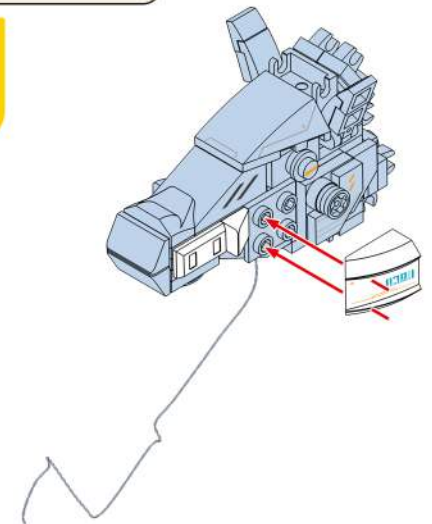

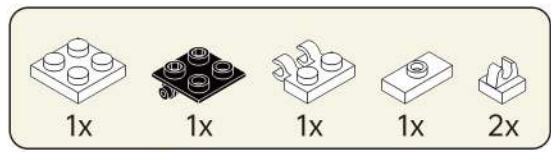

193

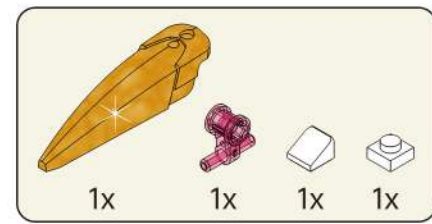
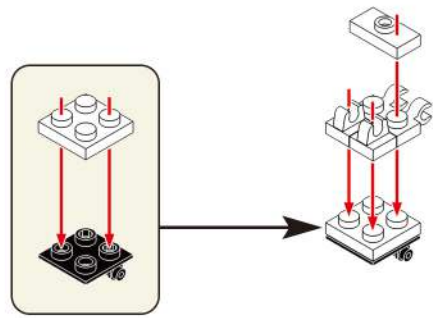

194

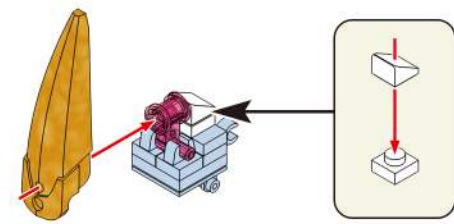

195

192

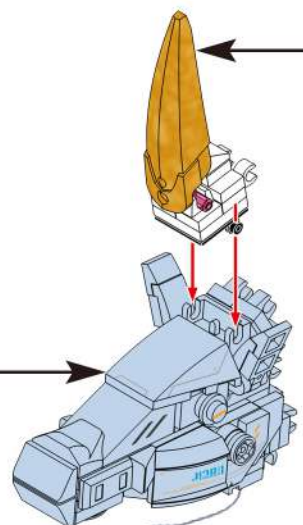

194

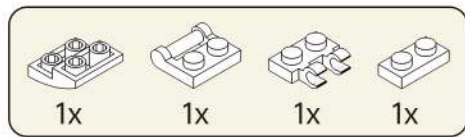

196

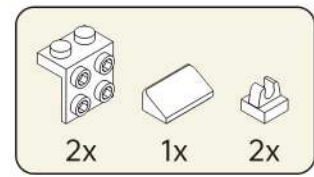
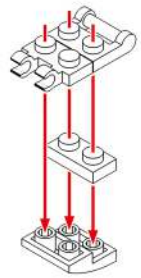

197

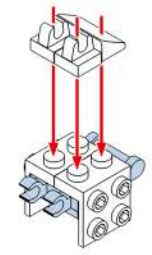

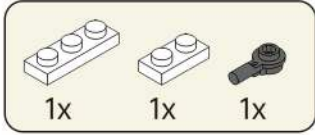

198

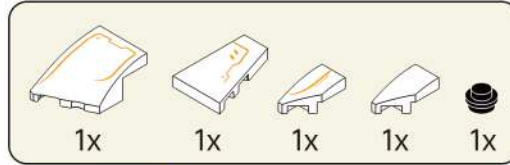
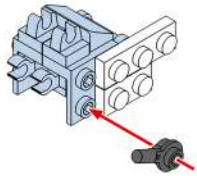

199

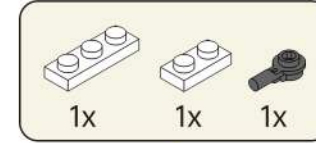
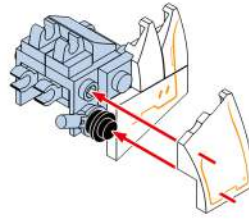

200

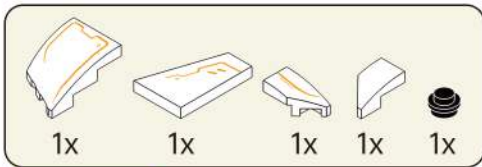
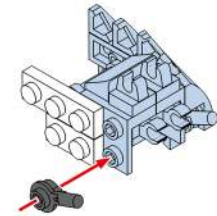

201

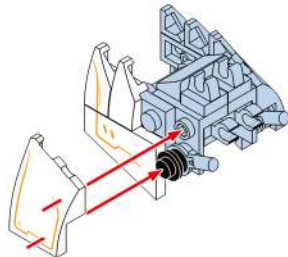

202



201

195

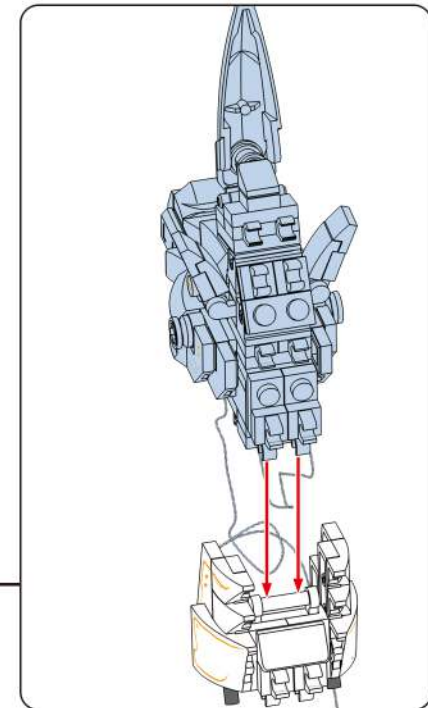
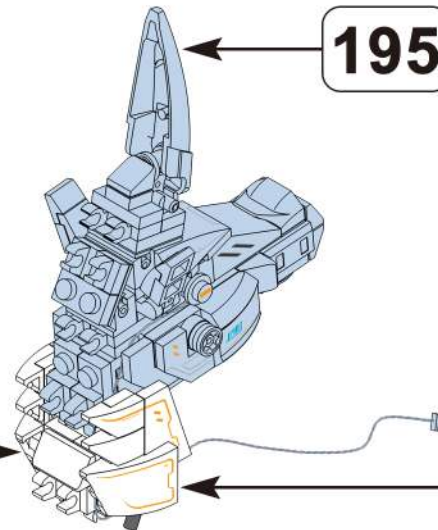

203

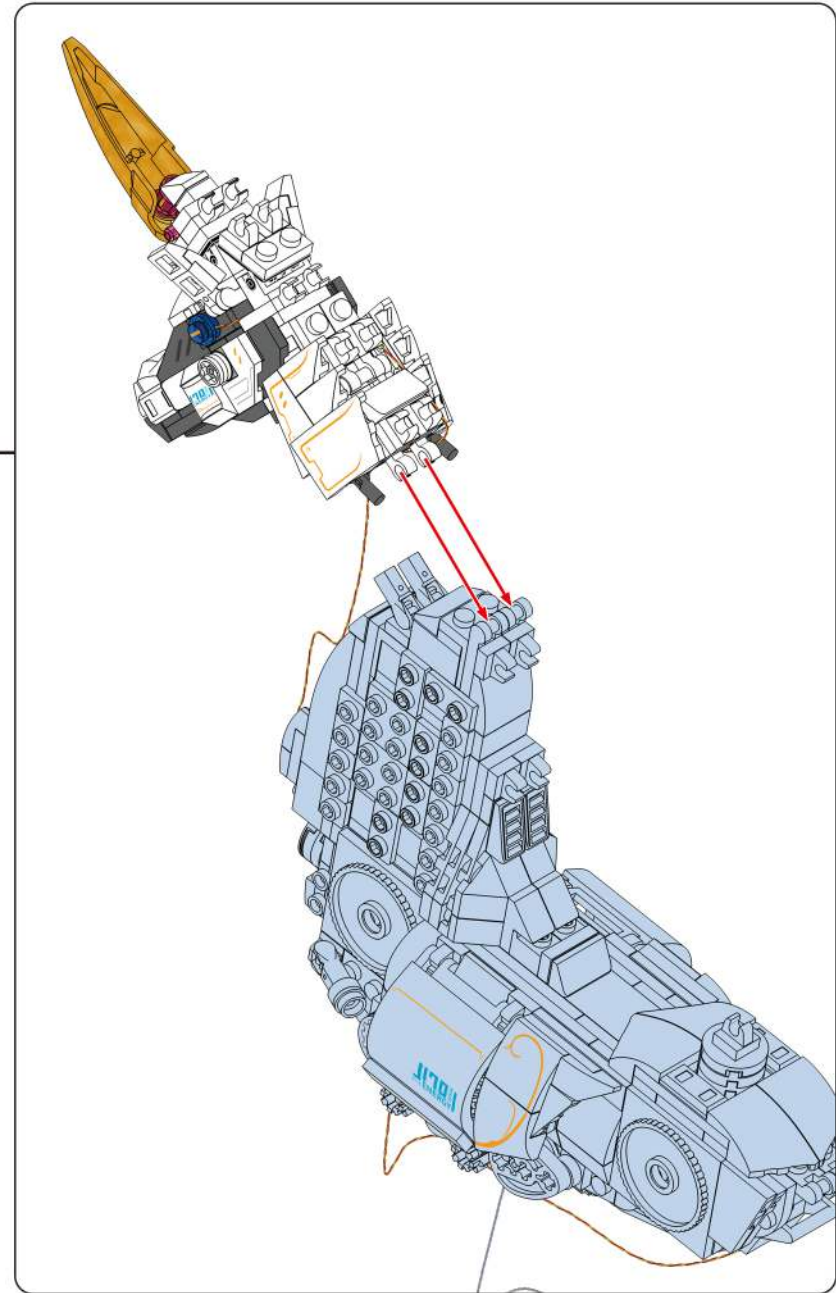
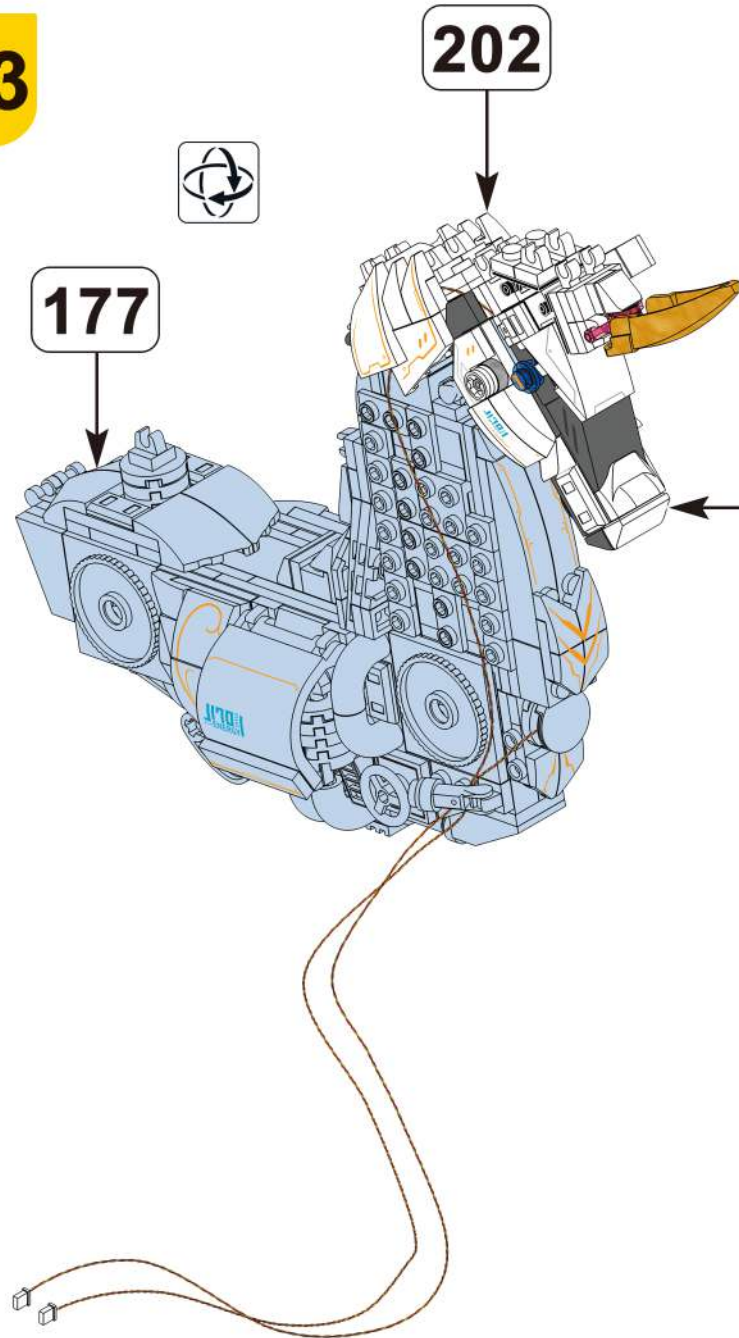

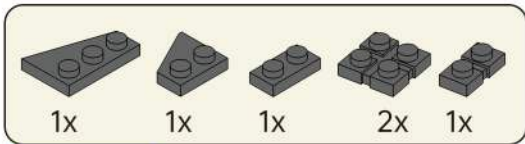

204

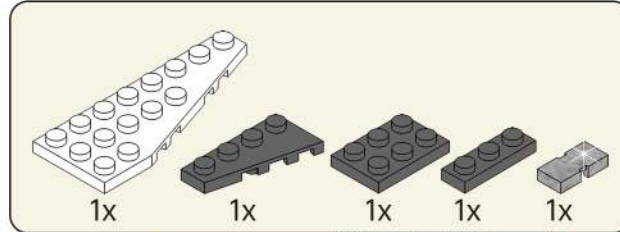
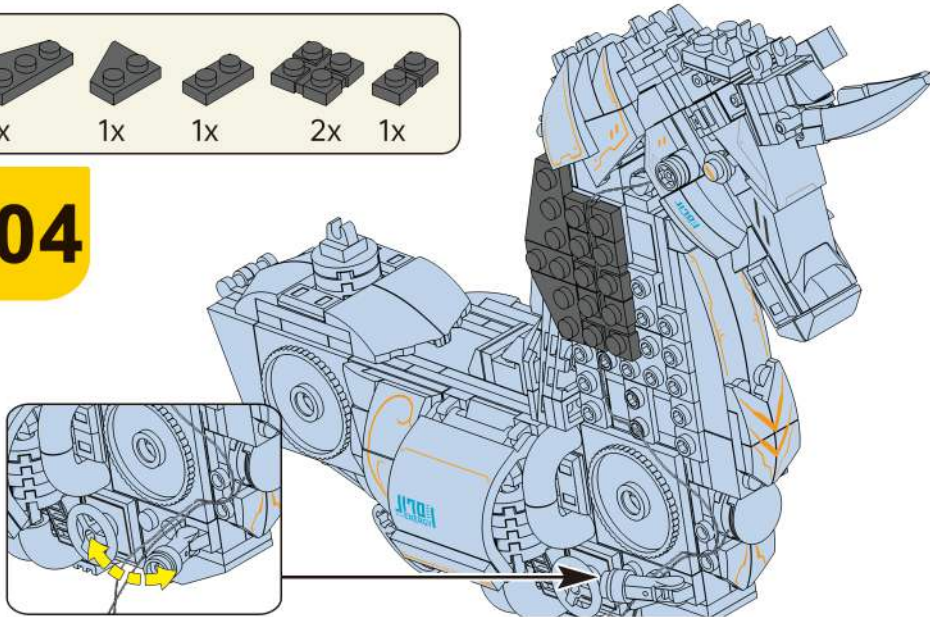

205

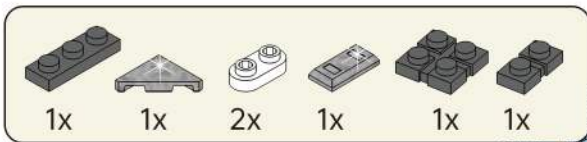
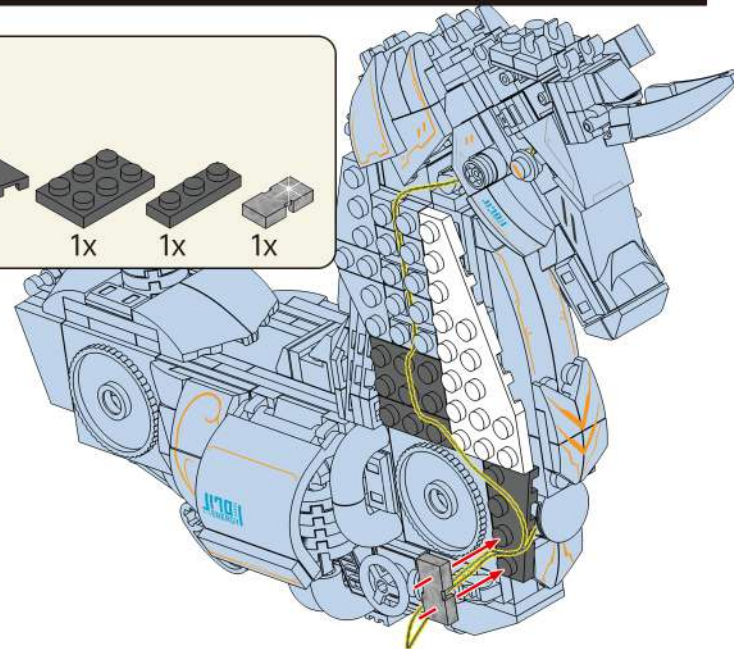

206

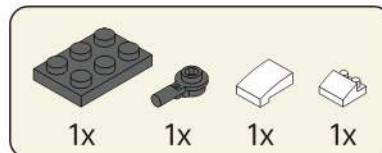
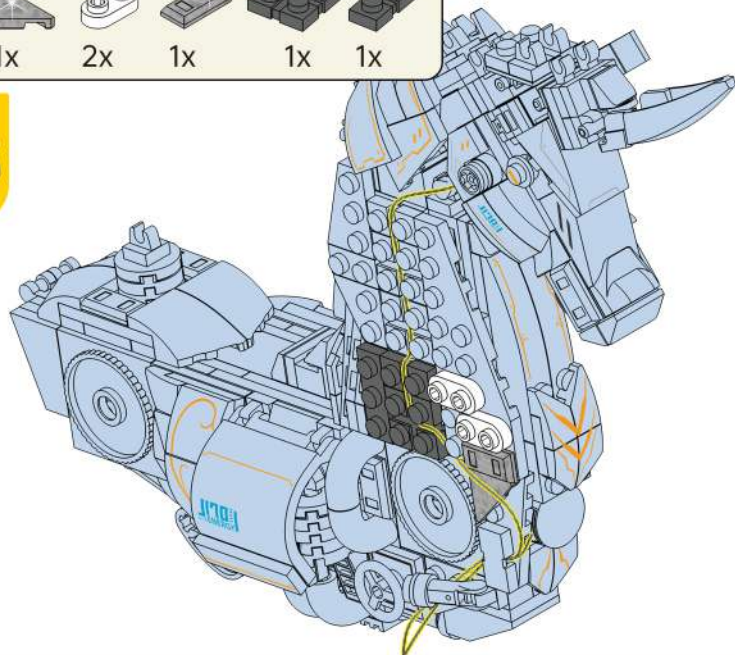

207

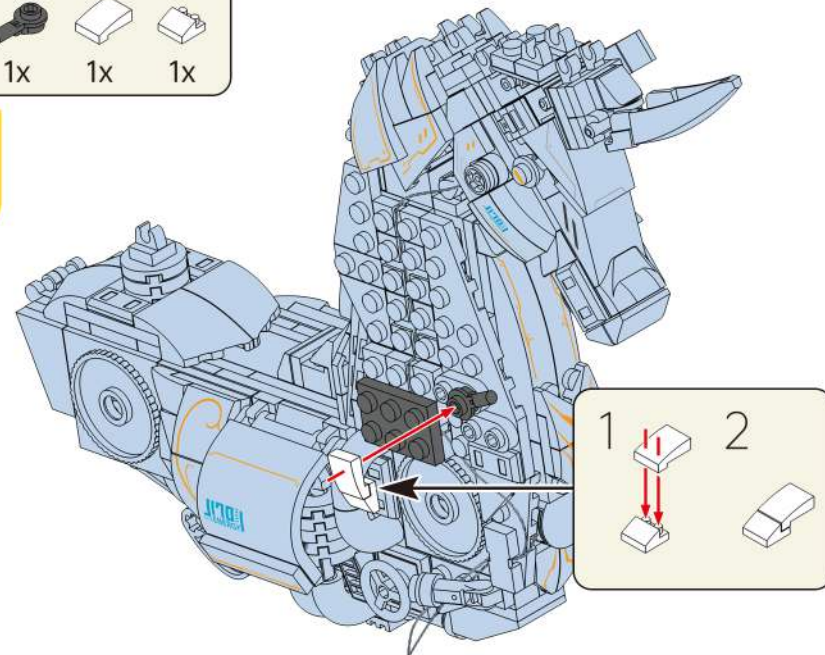

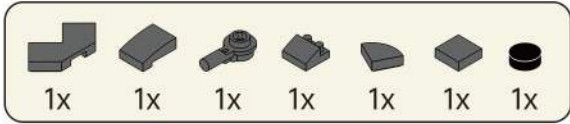

208

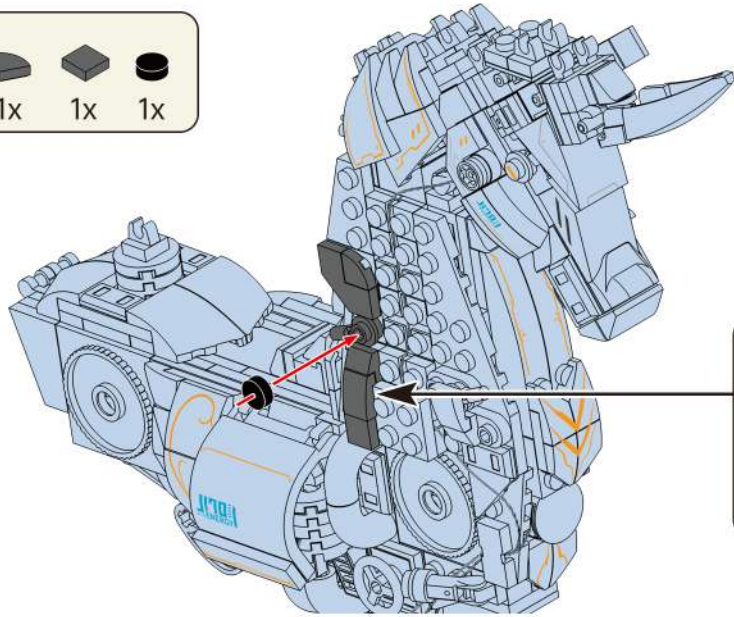

The product contains special parts, please pay attention when assembling!

$\text{1x2 brick with hole} + \text{1x2 brick with hole} = \text{L-shaped brick} = \text{L-shaped brick}$

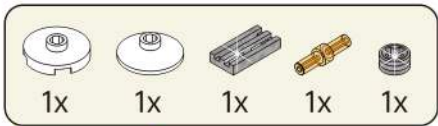
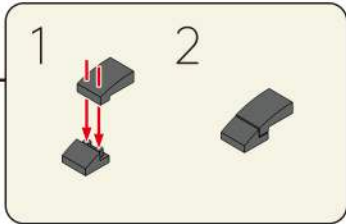

209

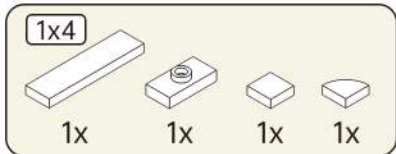
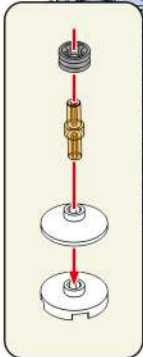
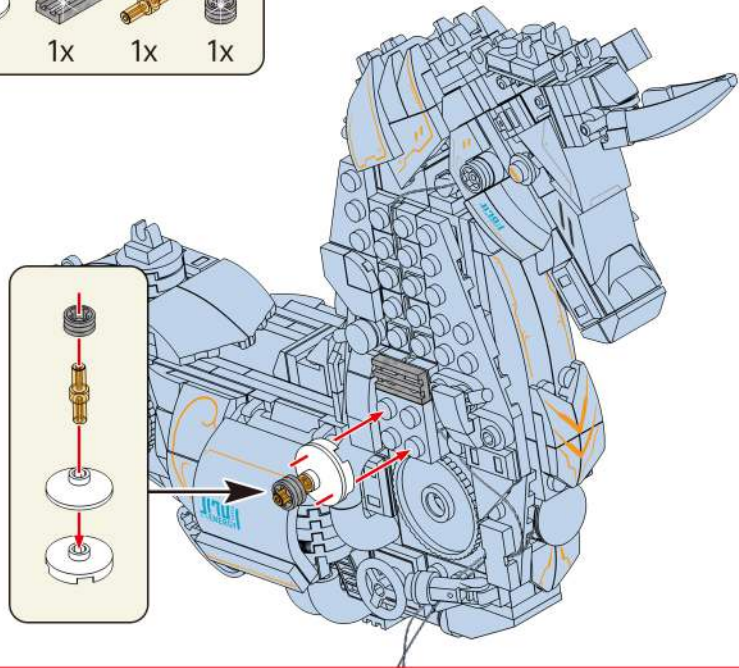

210

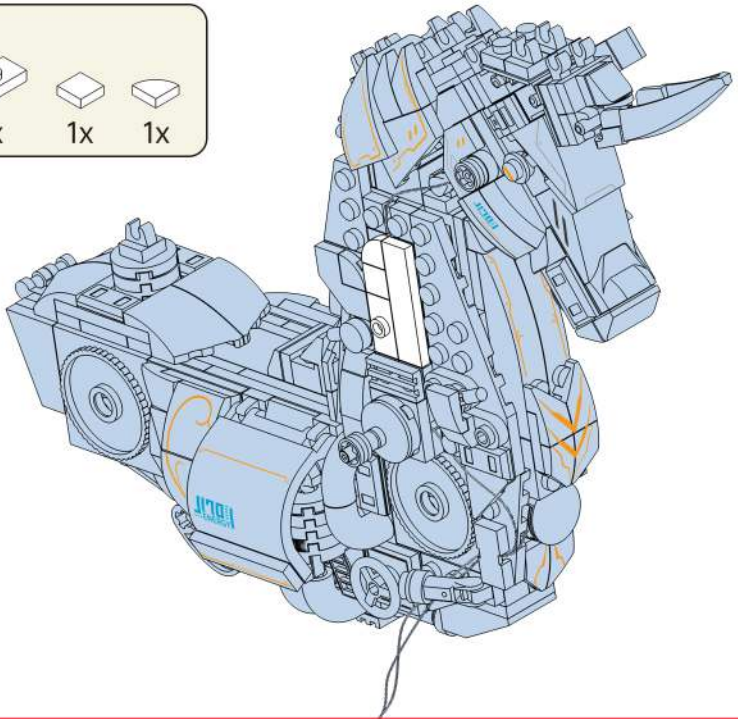

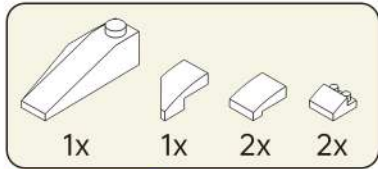

211

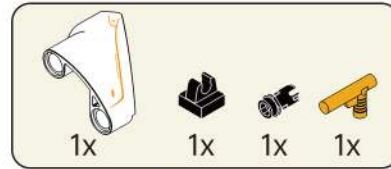
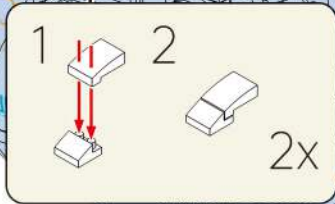
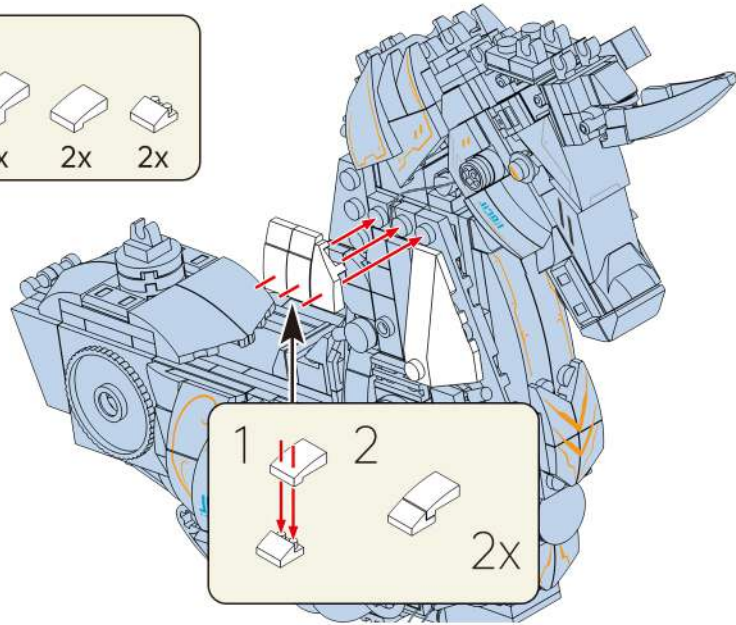

212

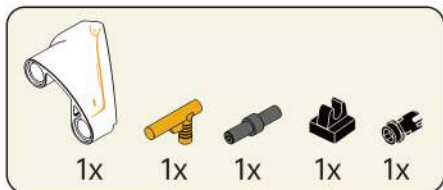
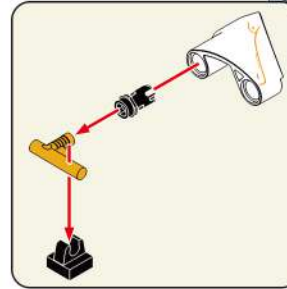
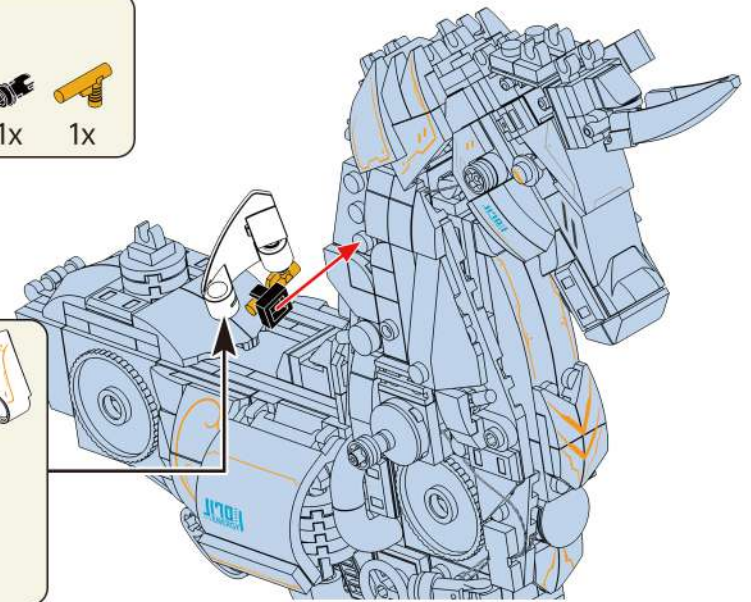

213

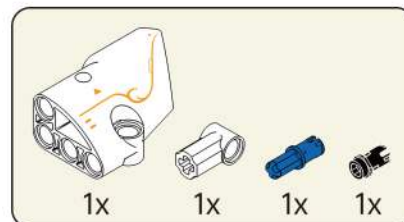
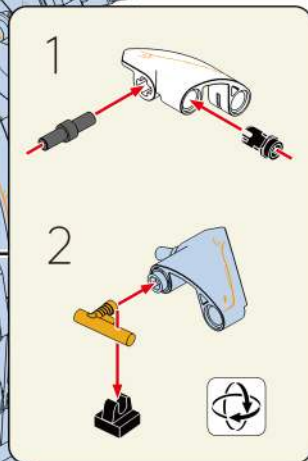
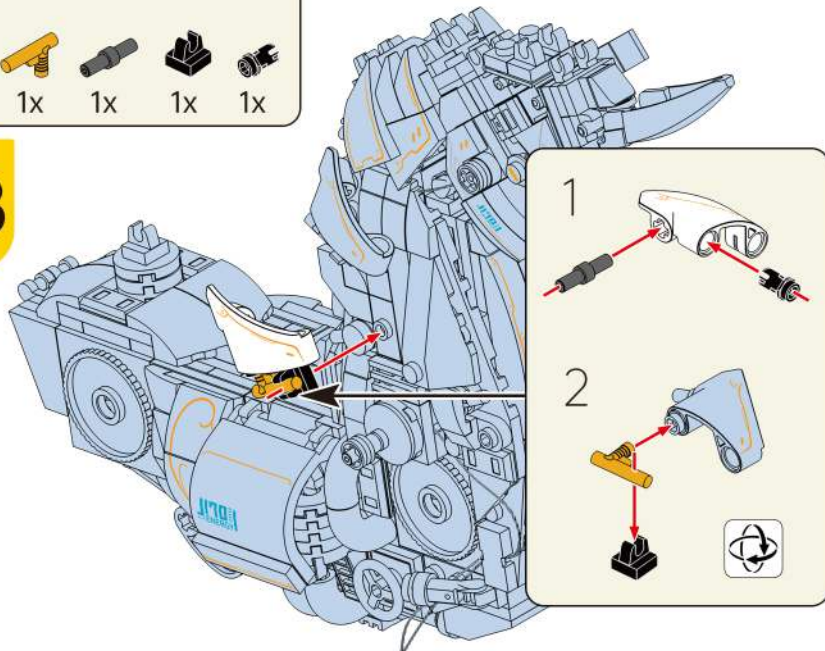

214

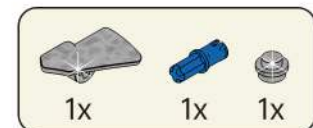
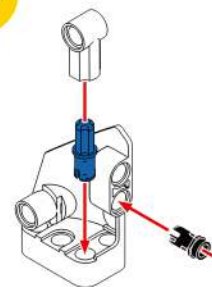

215

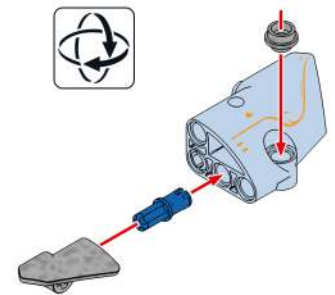

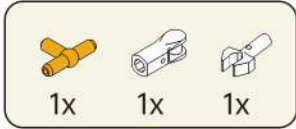

216

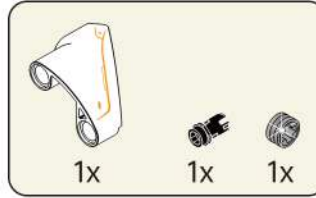
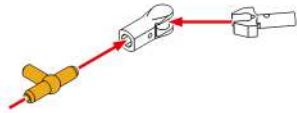

217

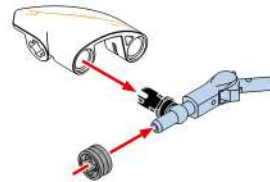

218

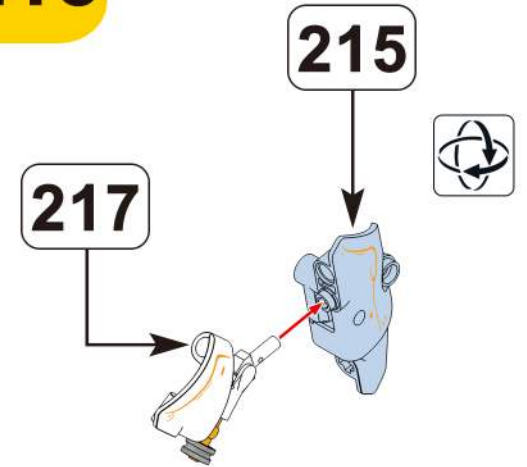

219

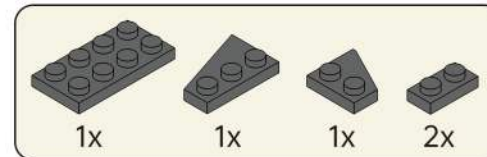
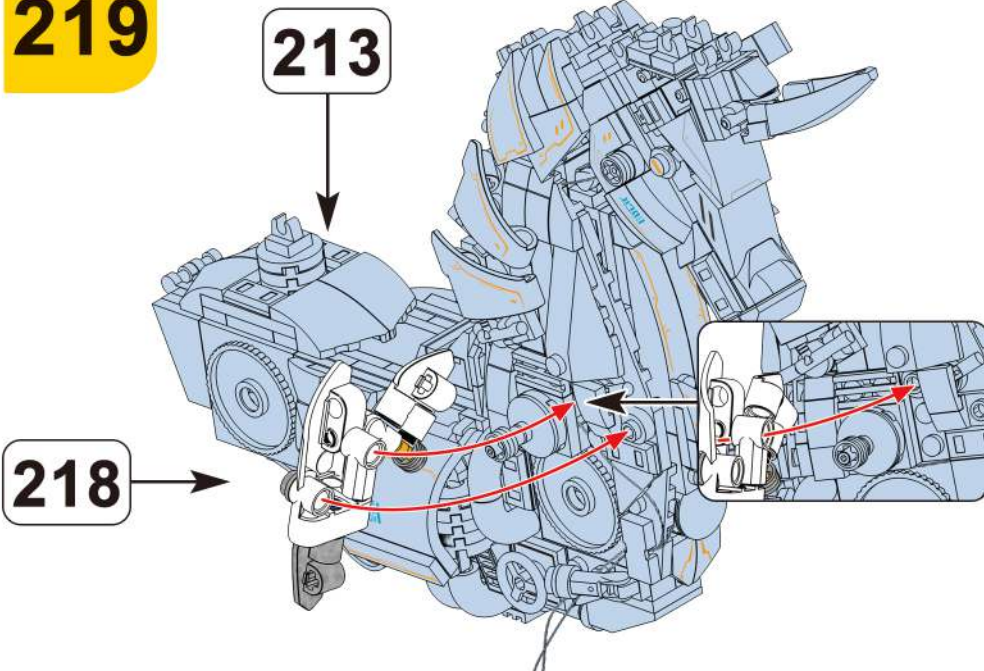

220

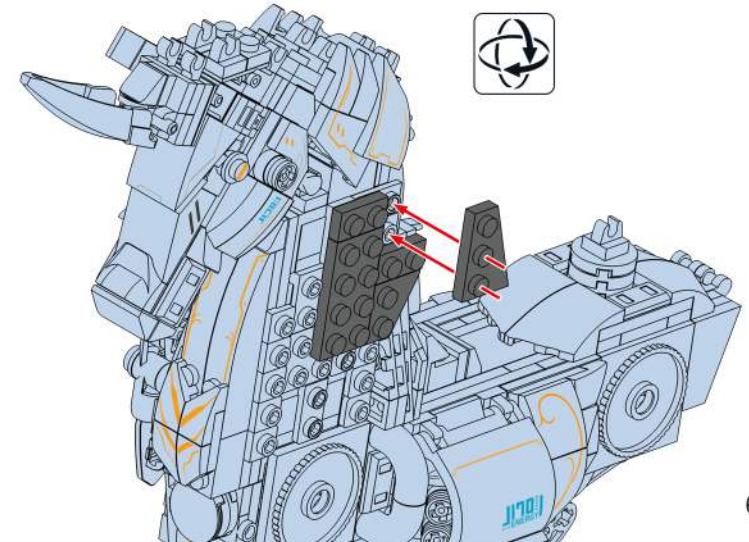

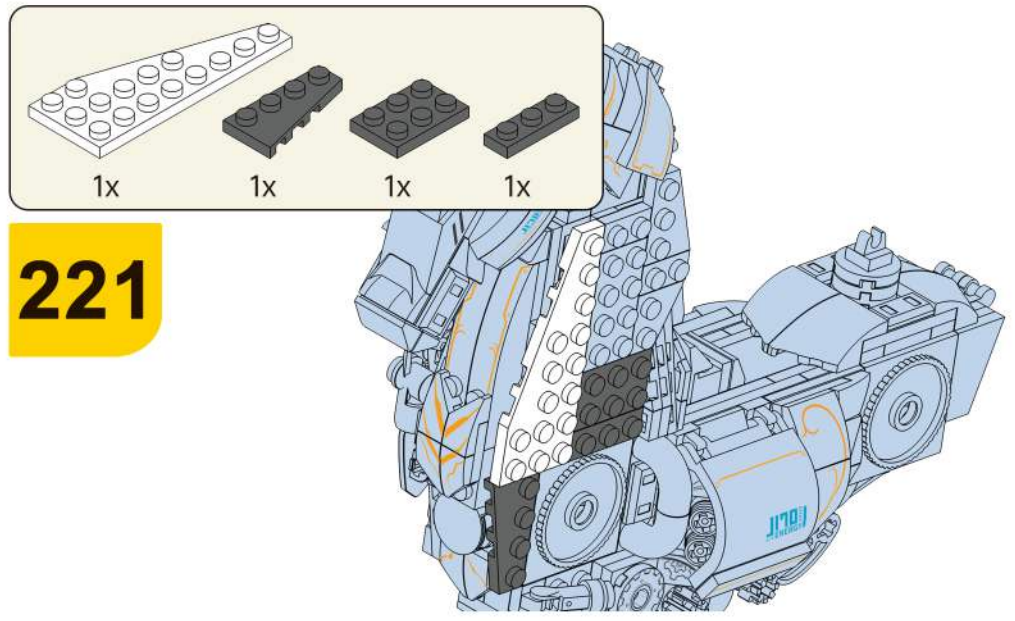

221

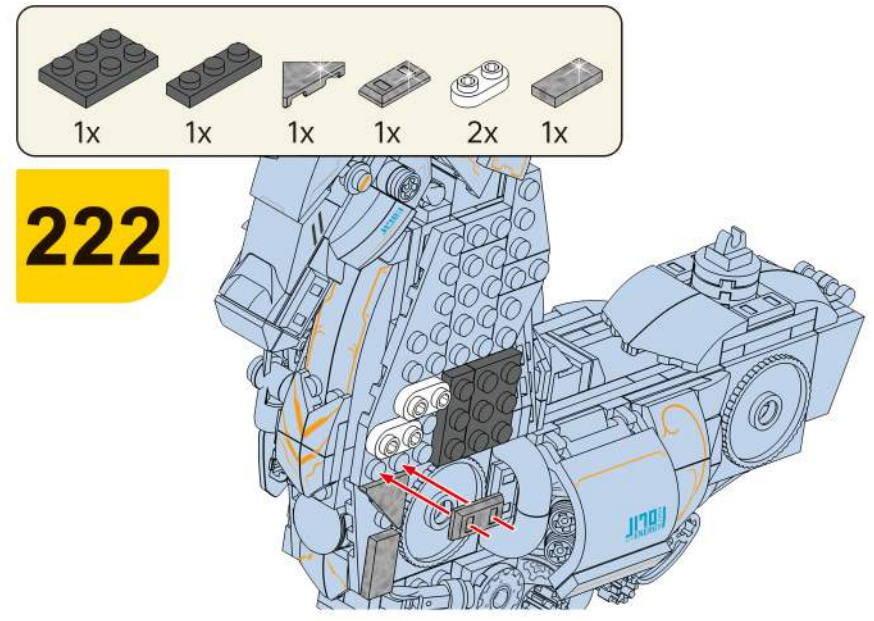

222

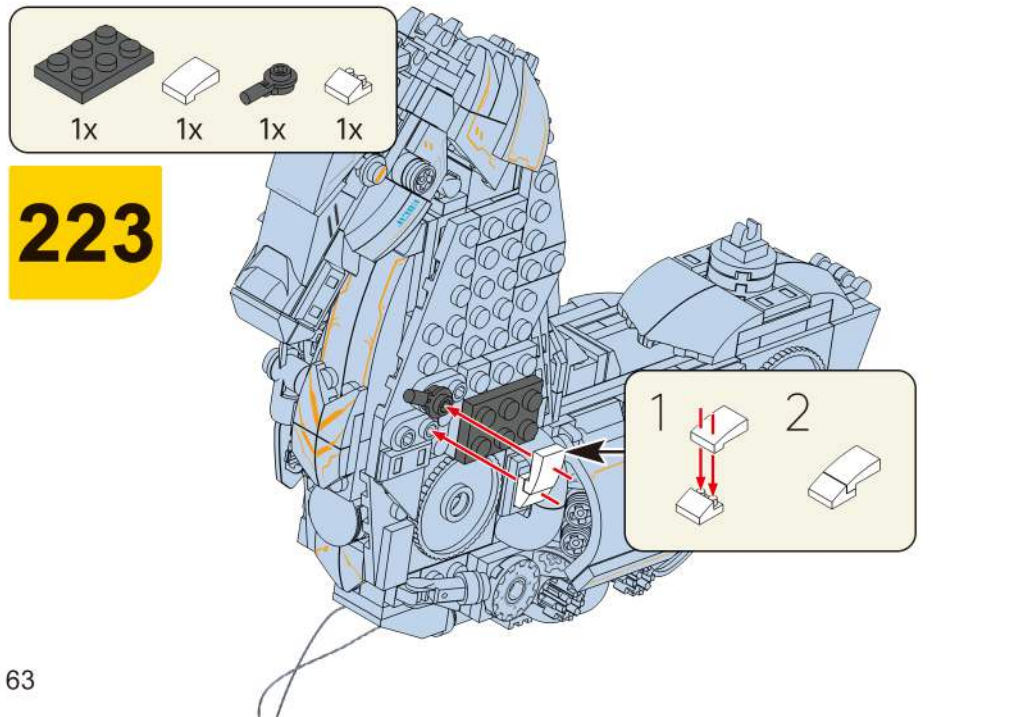

223

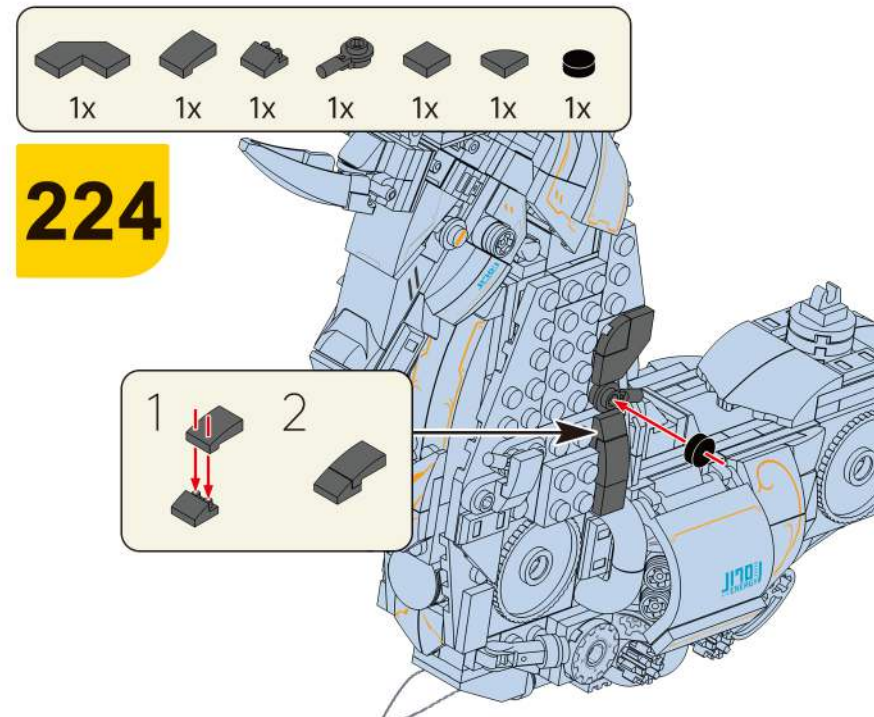

224

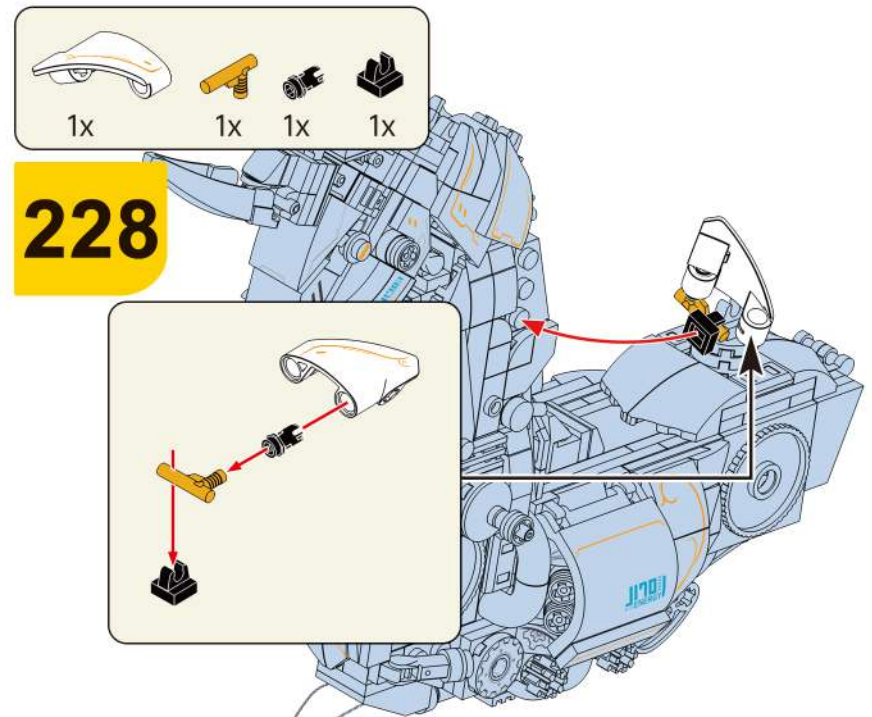
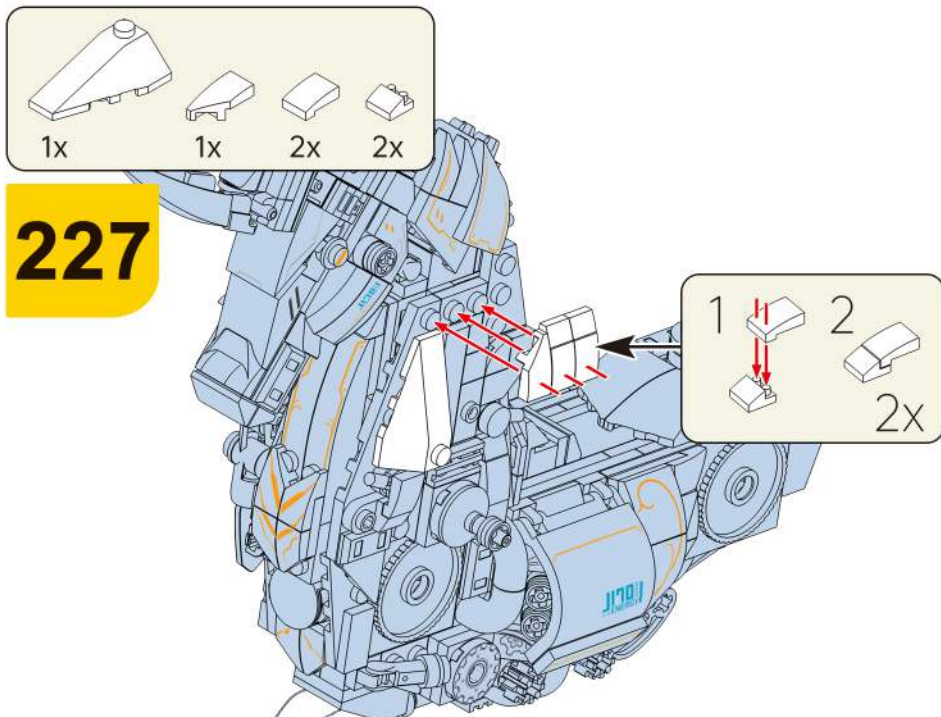
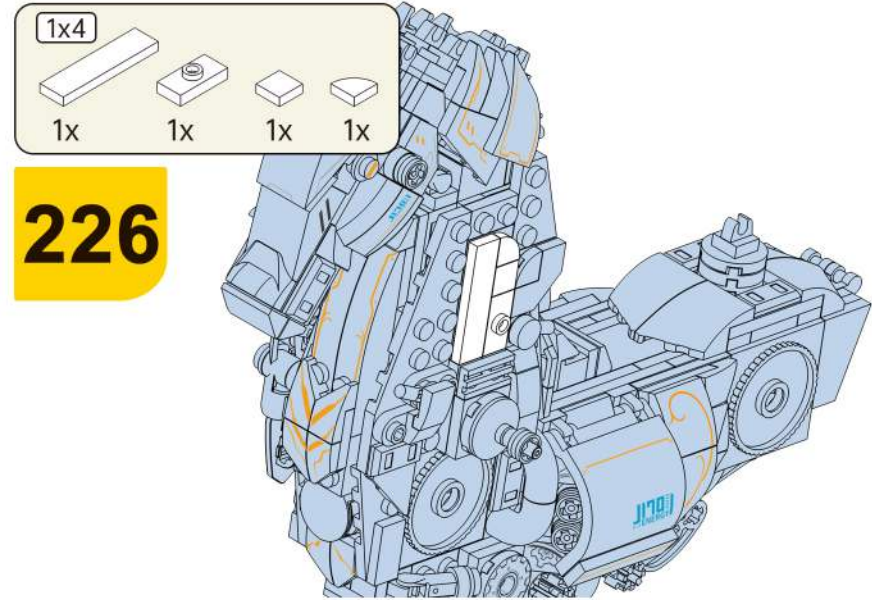
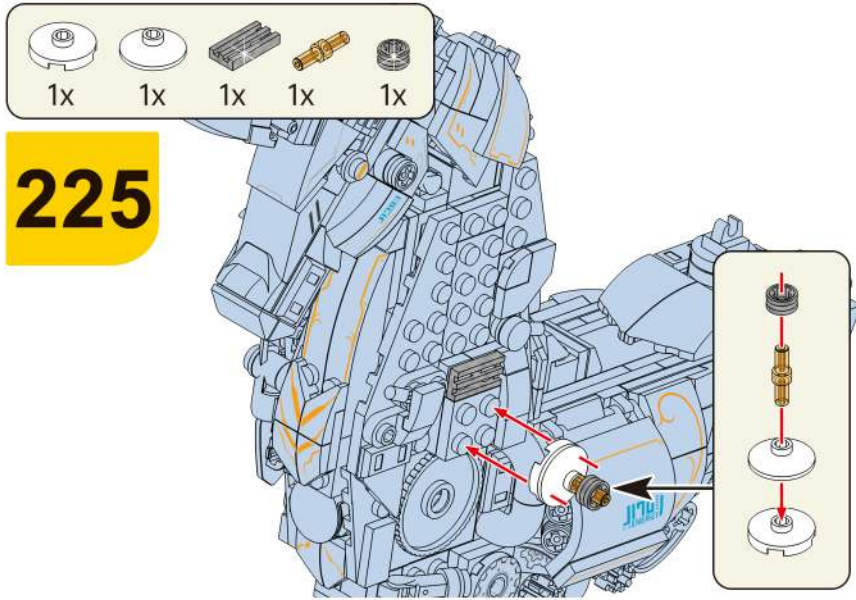

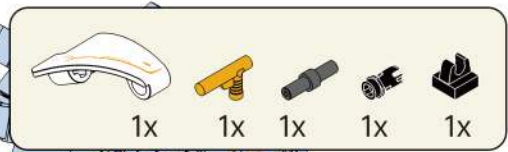

229

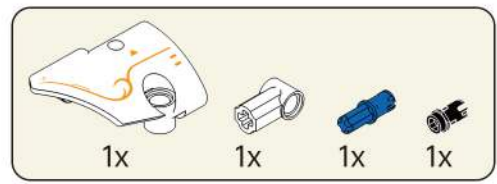
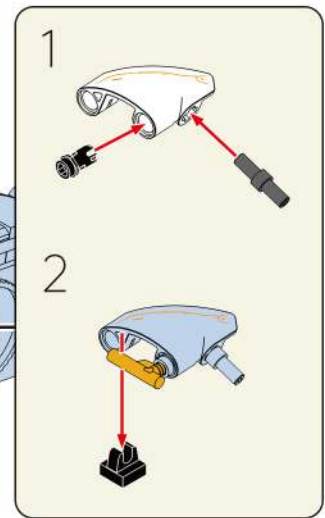

230

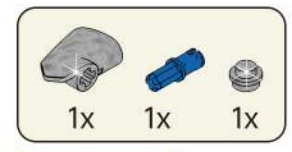
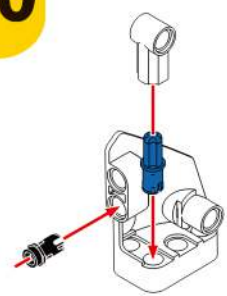

231

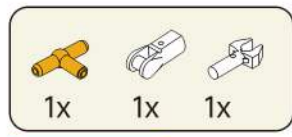
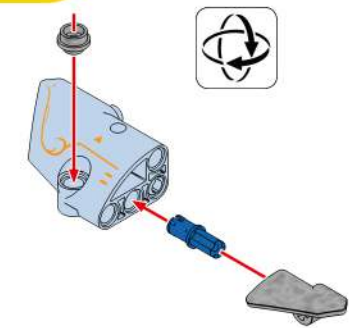

232

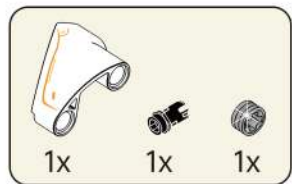
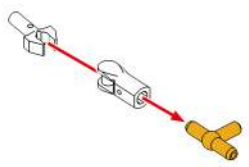

233

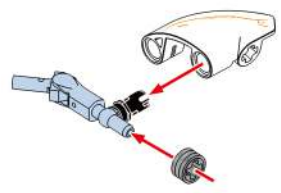

234

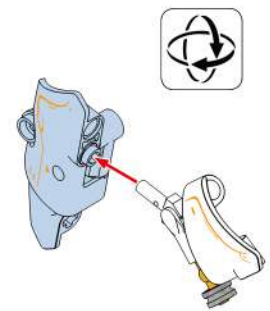

235

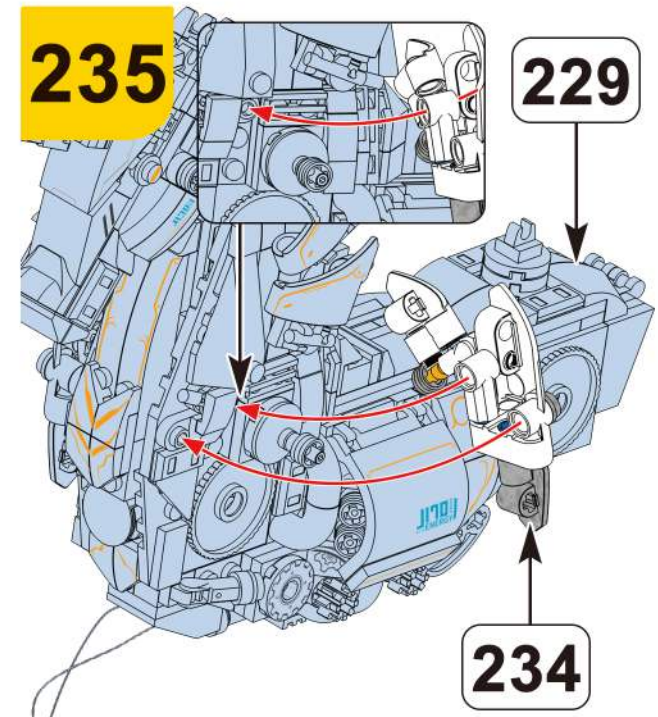

JOY MAKES BRILLIANCE.

Embrace Relaxation Embrace Joy

Every adultescent needs a "JOY BOX".
Please, open your JOY BOX! Heading for joy.

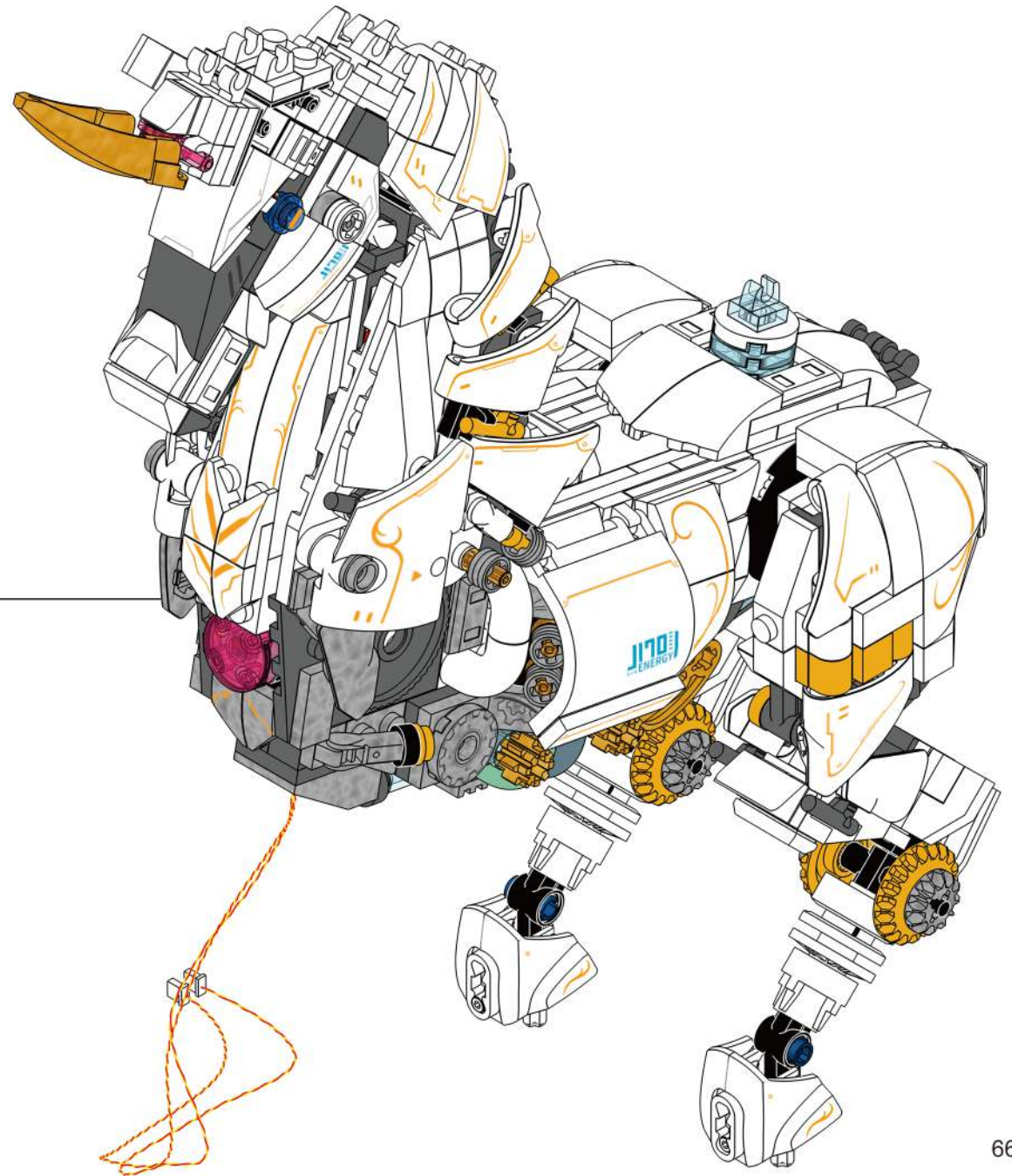

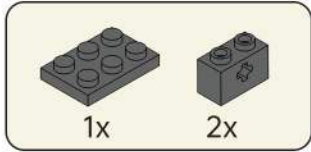

236

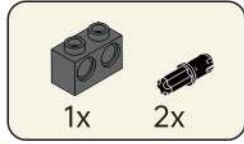
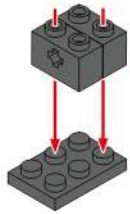

237

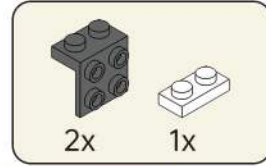
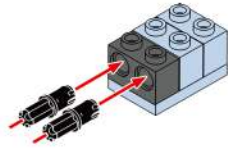

238

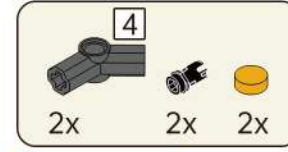
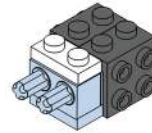

239

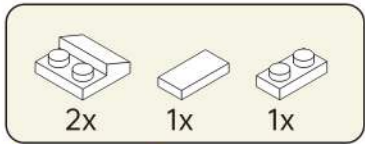
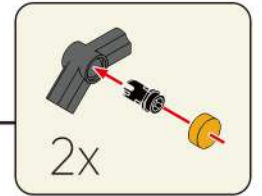
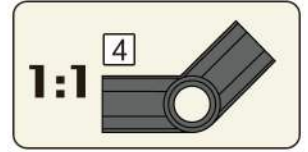
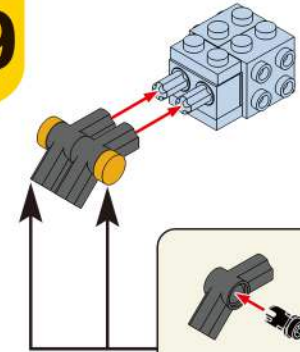

240

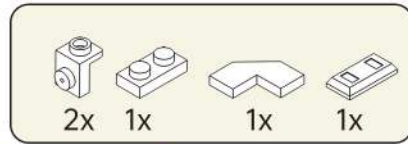
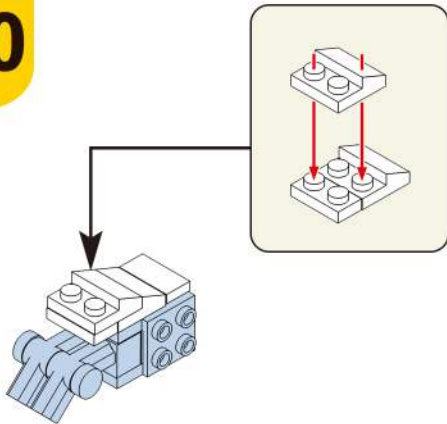

241

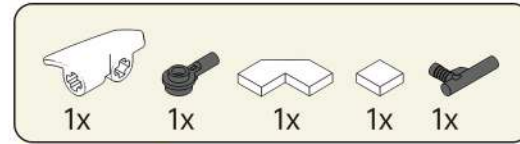
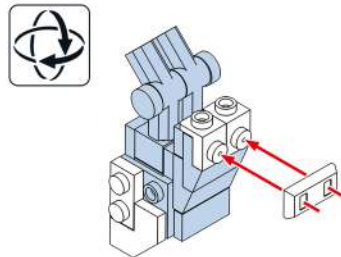

242

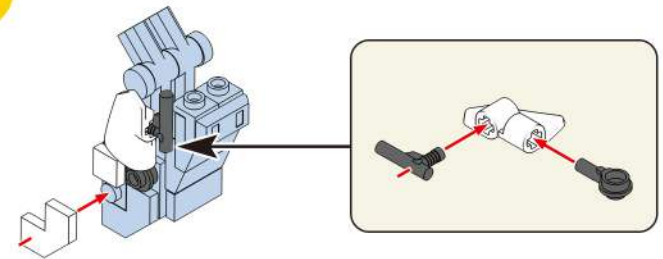

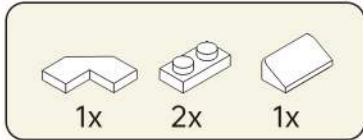

243

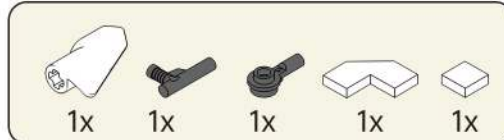
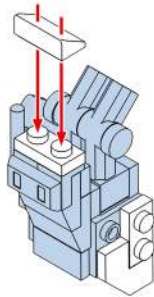

244

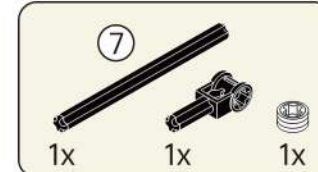
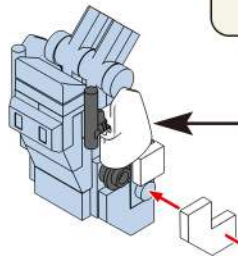
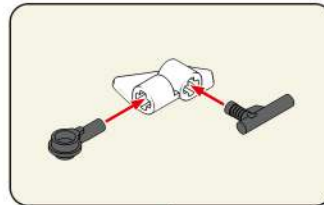

245

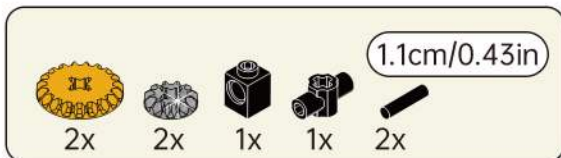
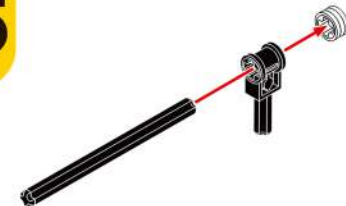

246

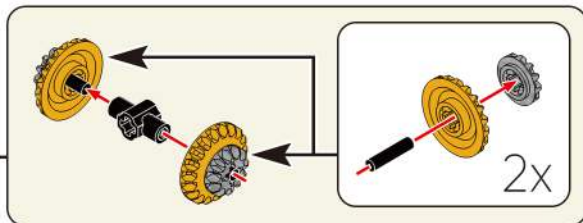
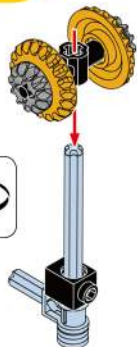

The length of the hose can be cut to the required length with scissors.

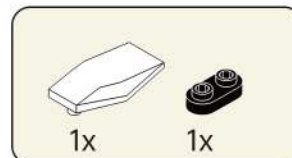
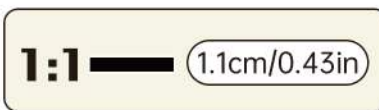

247

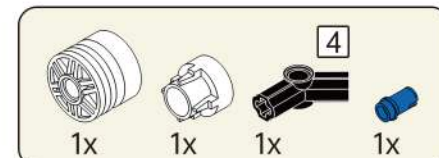
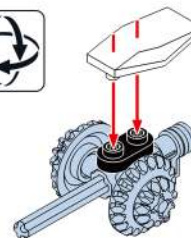

248

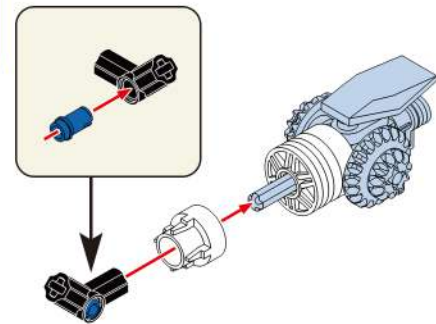

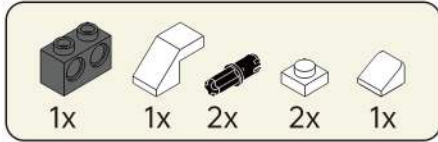

255

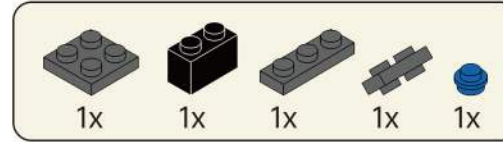
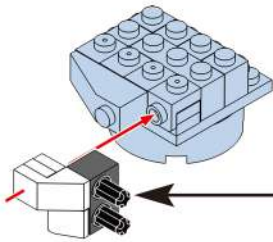
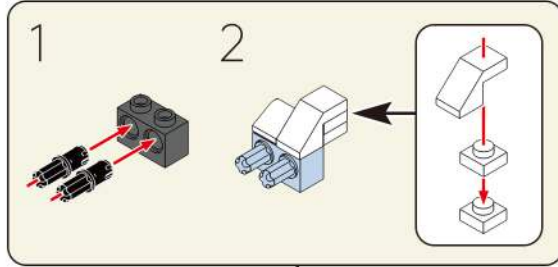

256

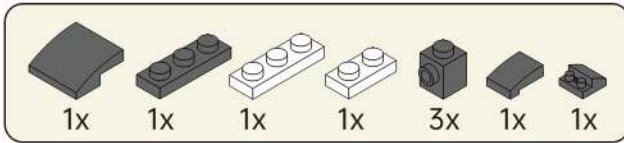
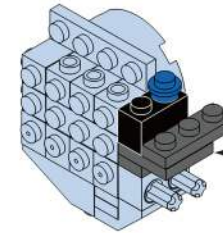
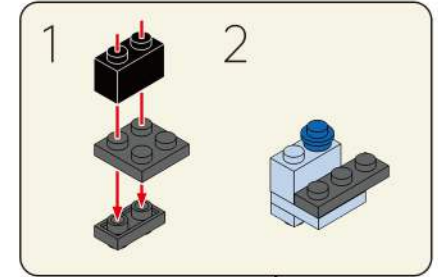

257

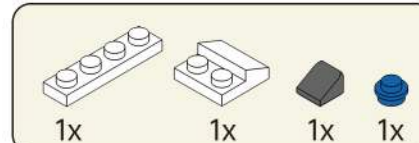
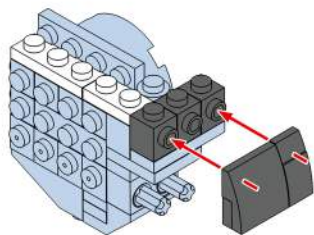
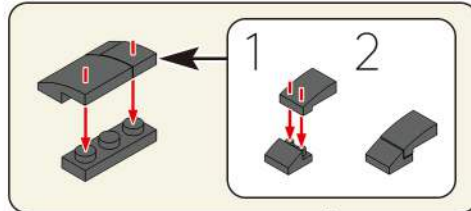

258

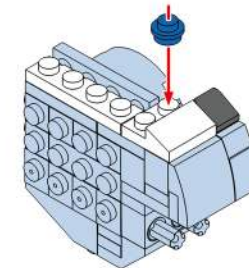

259

1x 1x 1x 1x 2x

260

1x 1x 1x

261

1x 1x 1x

262

1x 1x 1x

263

1x 1x 1x 1x

264

1x 1x 1x

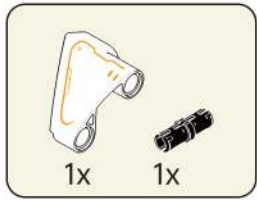

265

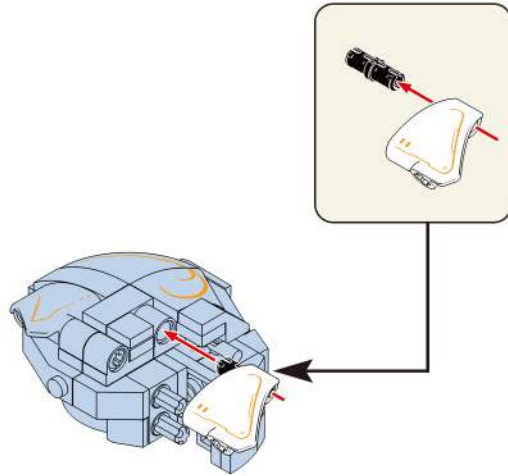

266

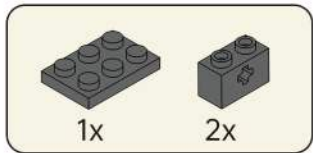
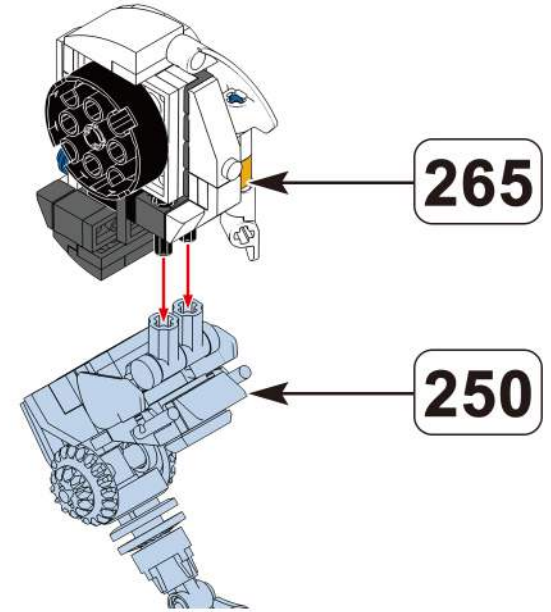

267

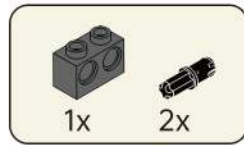
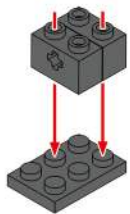

268

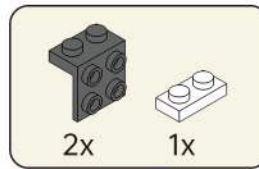
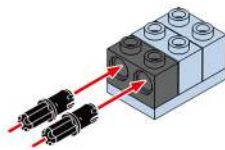

269

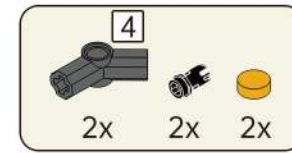
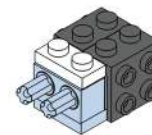

270

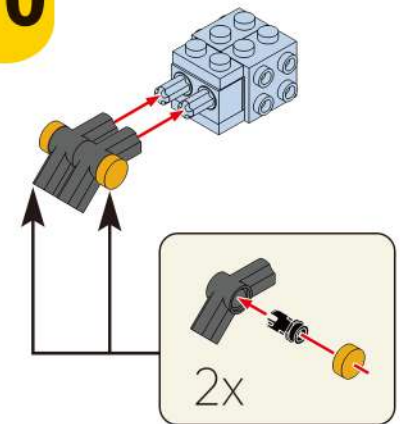
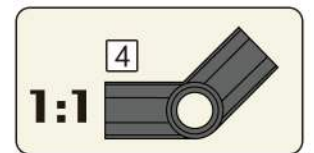

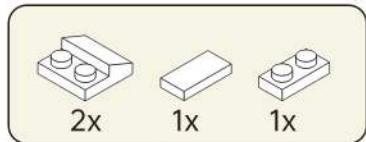

271

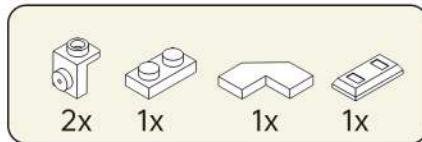
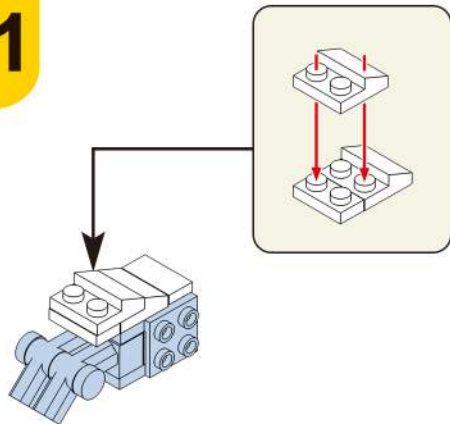

272

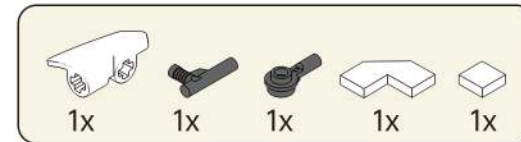
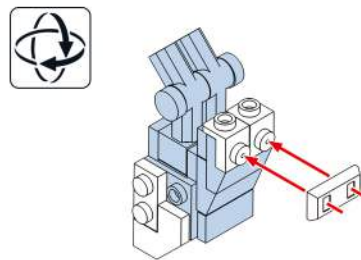

273

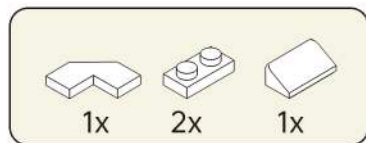
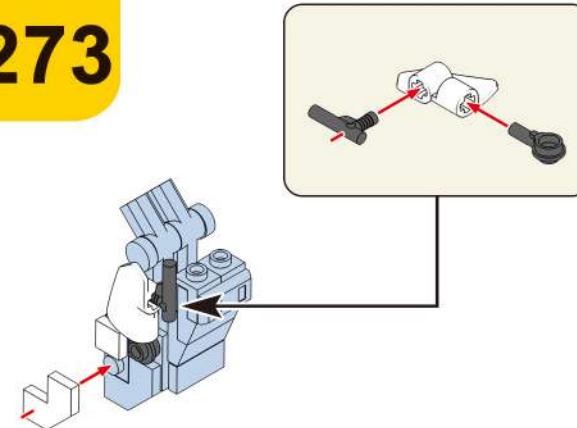

274

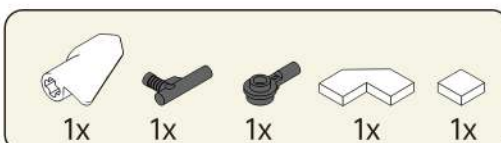
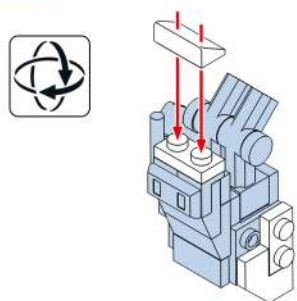

275

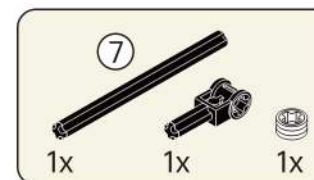
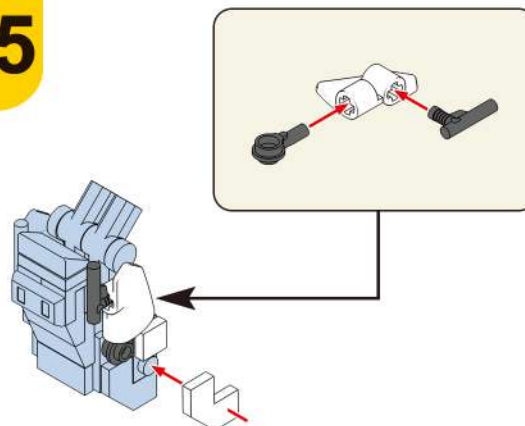

276



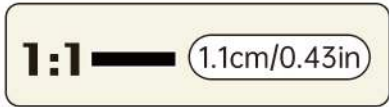
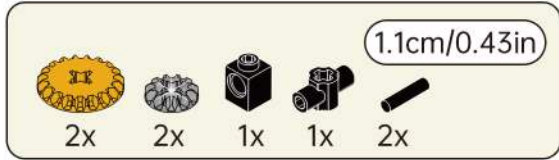

277

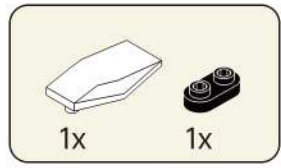
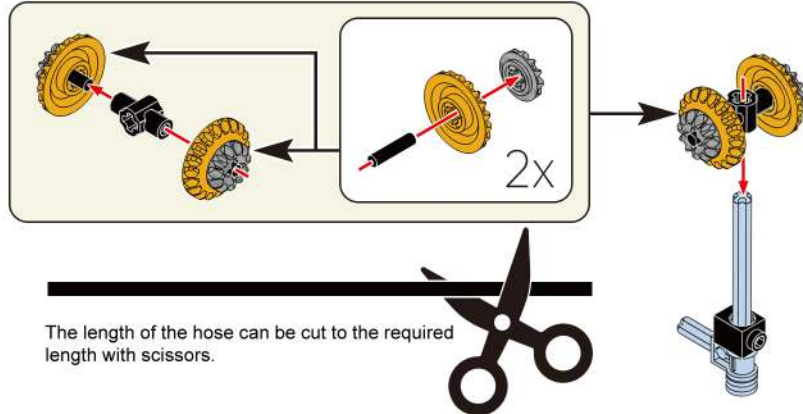

278

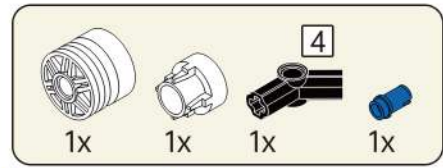
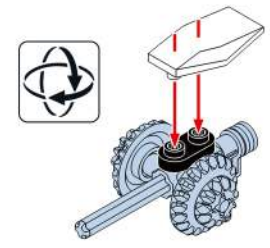

279

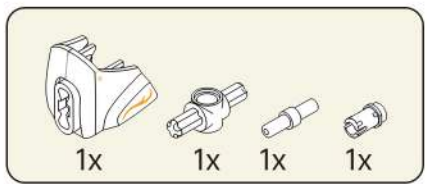
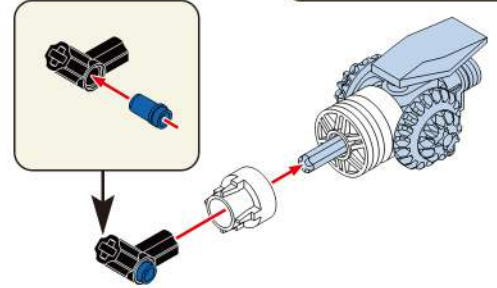
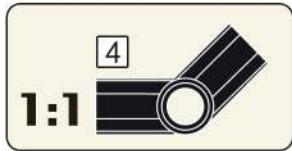

280

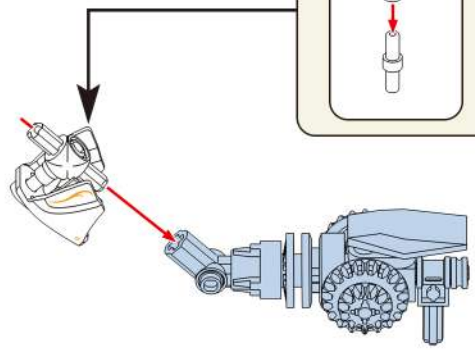
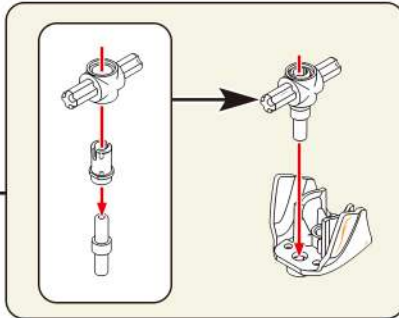

281

280

275

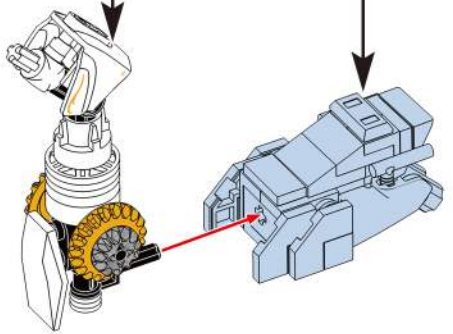

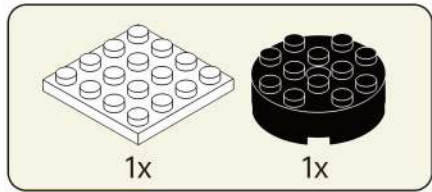

282

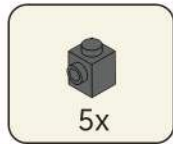
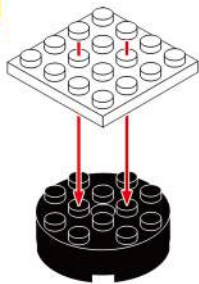

283

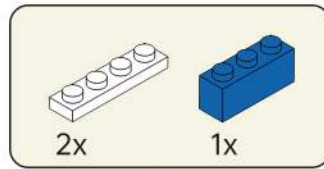
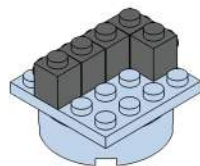

284

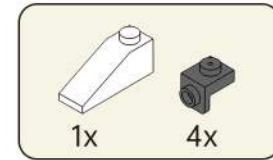
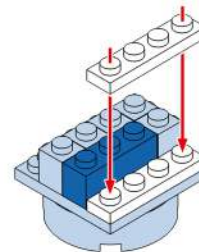

285

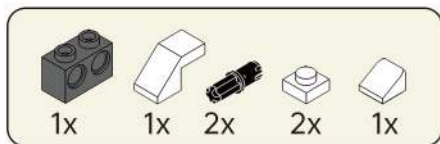
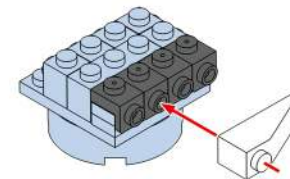

286

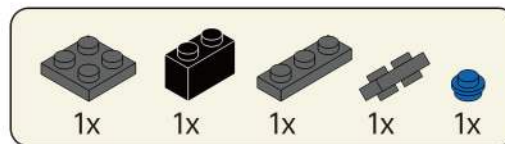
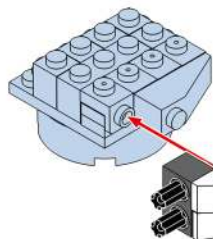
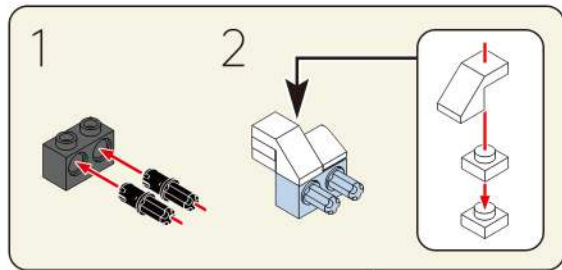

287

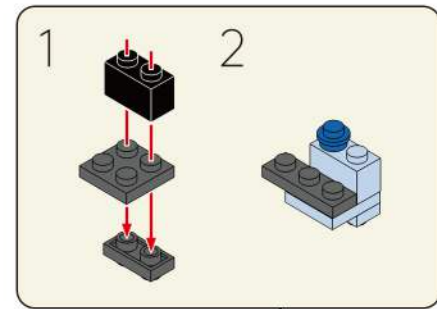
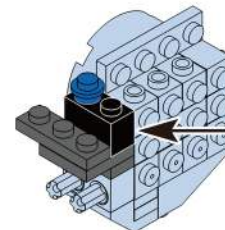

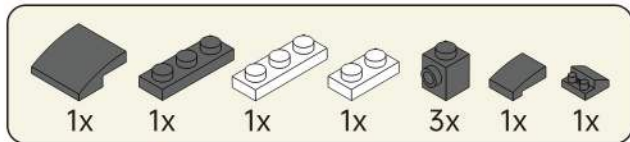

288

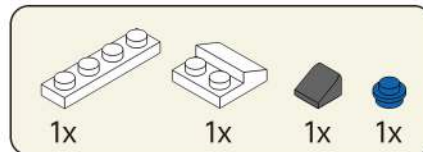
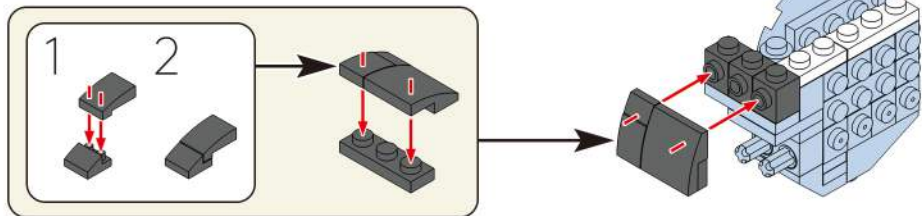

289

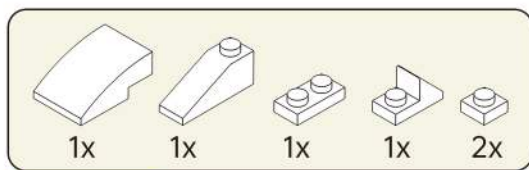
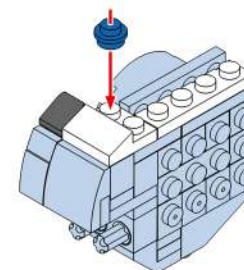

290

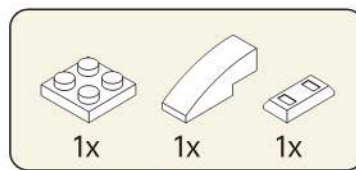
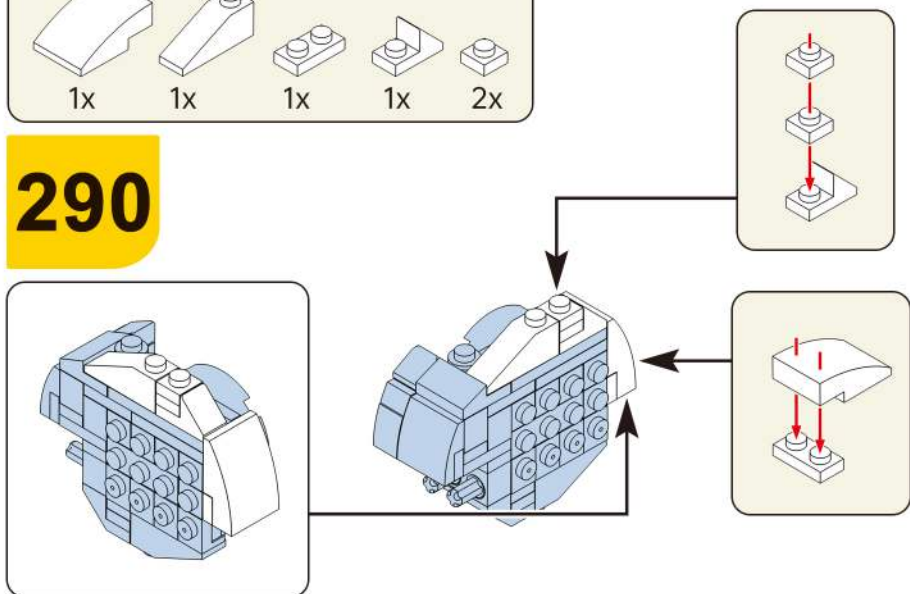

291

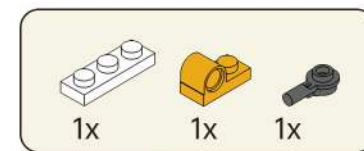
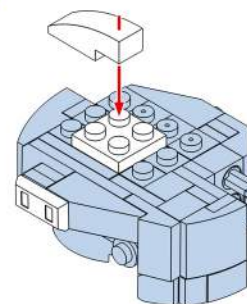

292

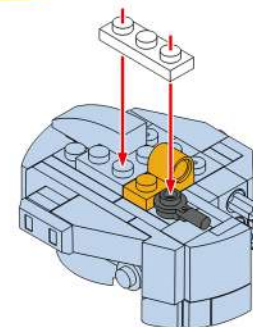

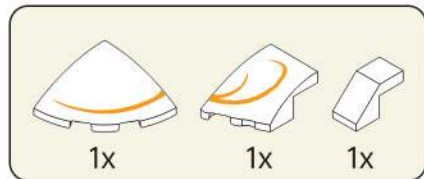

293

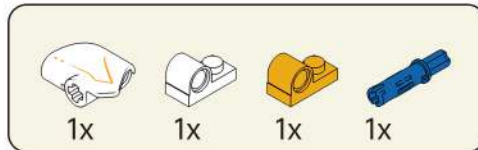
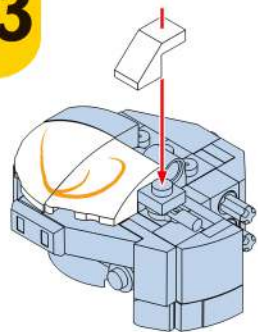

294

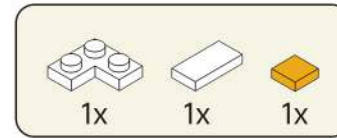
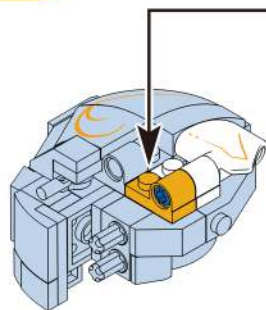
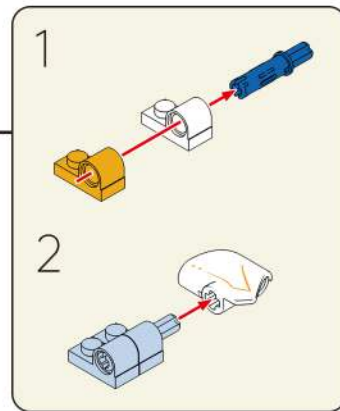

295

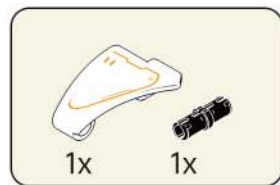
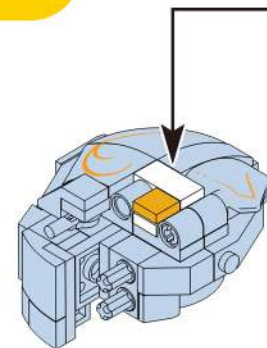
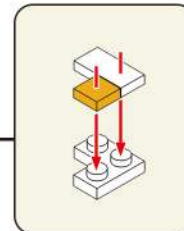

296

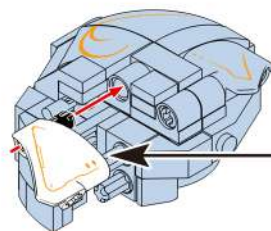
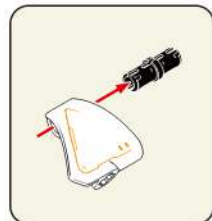

297

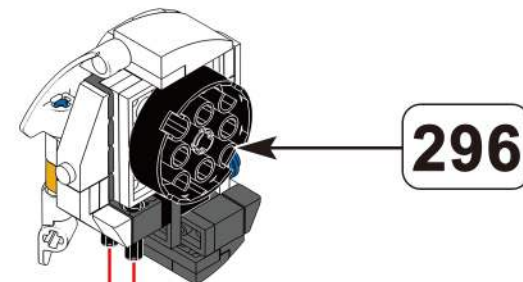

296

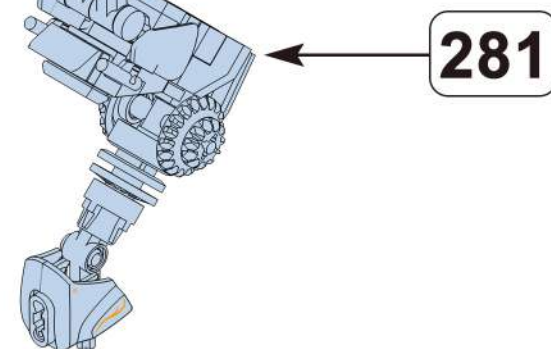

281

298

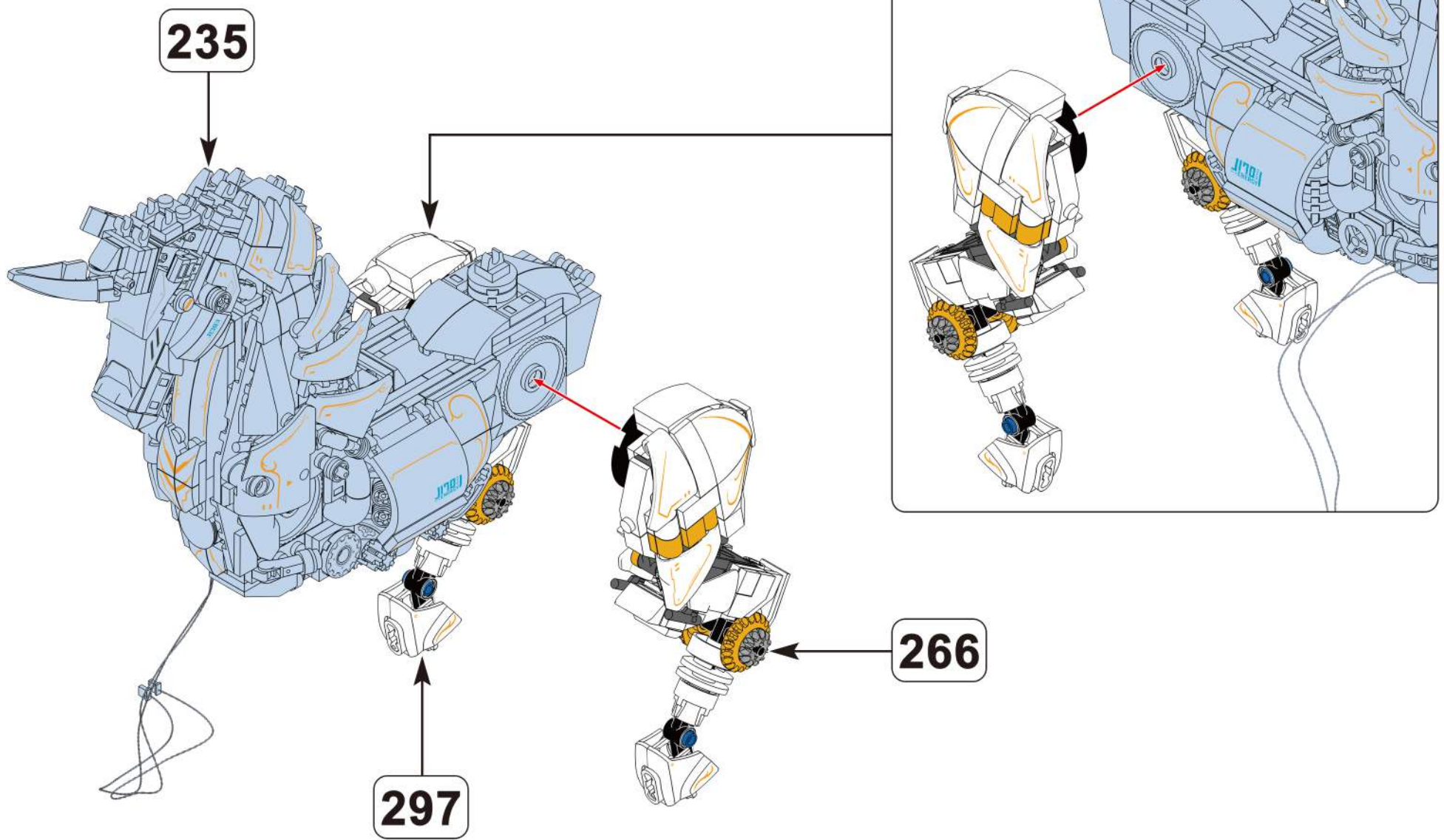

JOY MAKES BRILLIANCE.

Embrace Relaxation Embrace Joy

Every adultescent needs a "JOY BOX".
Please, open your JOY BOX! Heading for joy.

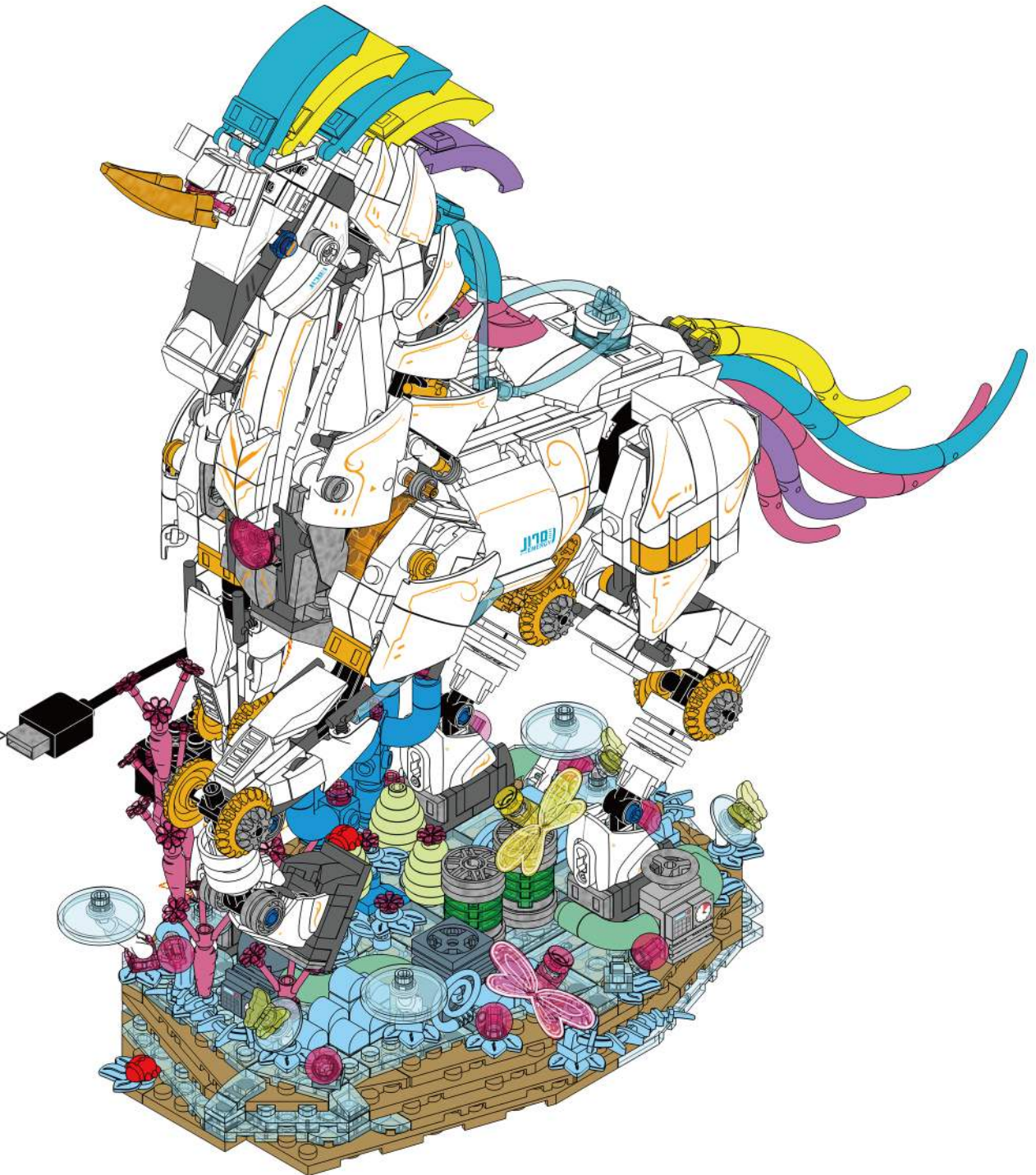

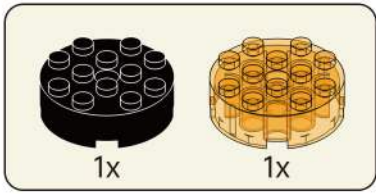

299

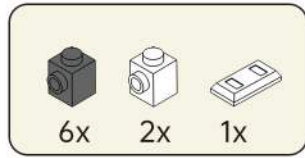
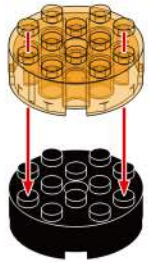

300

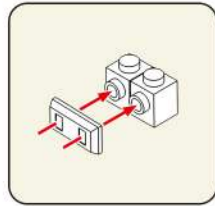

303

300

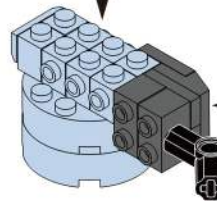

302

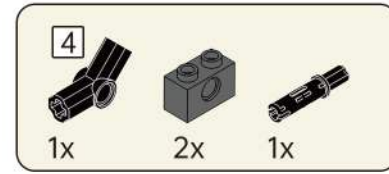

301

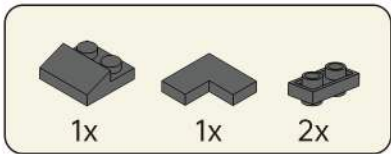
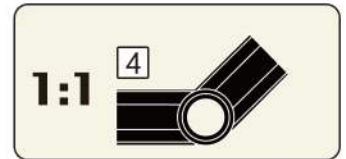
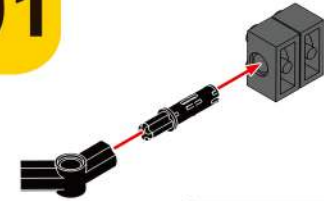

302

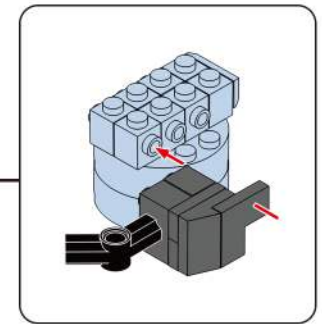
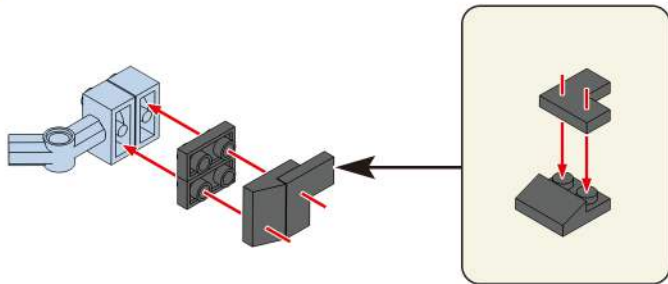

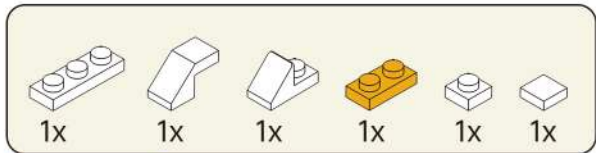

304

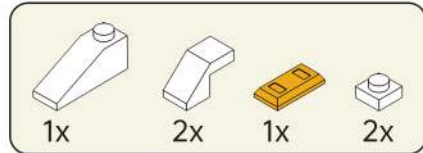
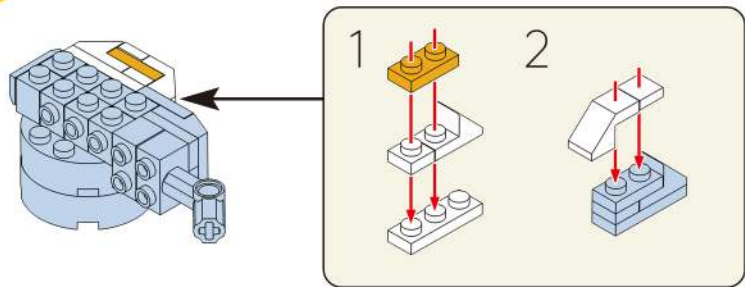

305

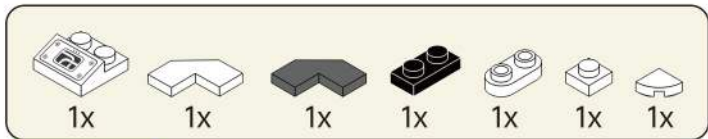
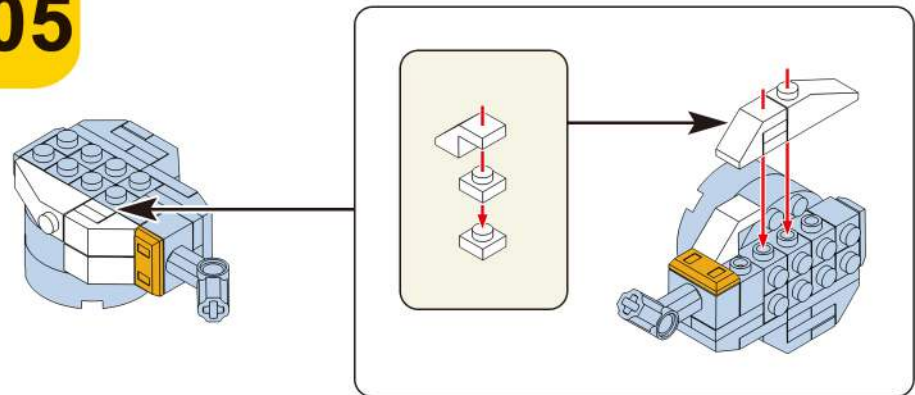

306

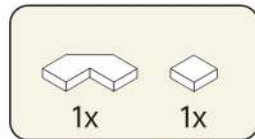
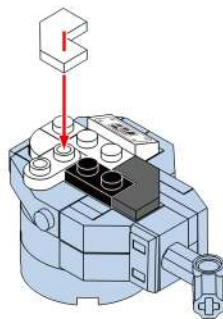

307

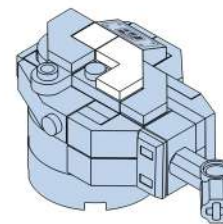

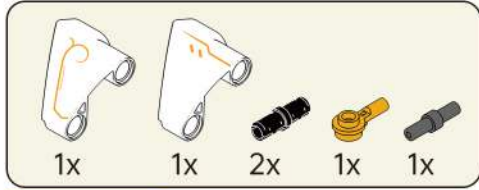

308

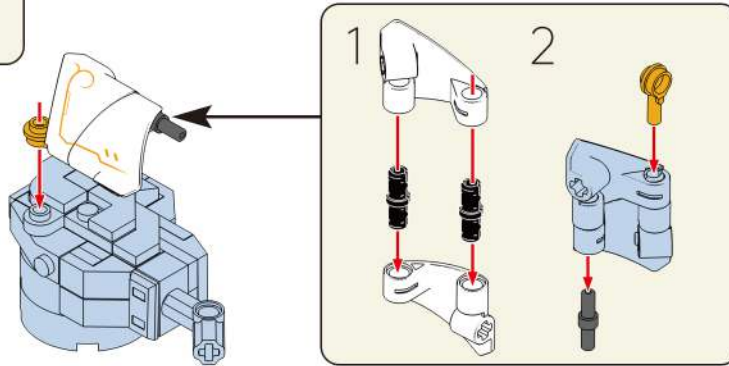

The printing accessories for this step, as shown in the diagram, are assembled together and need to be disassembled before installation.

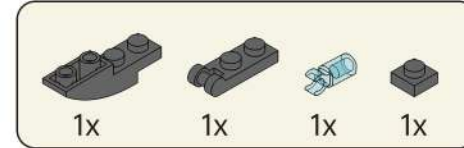

309

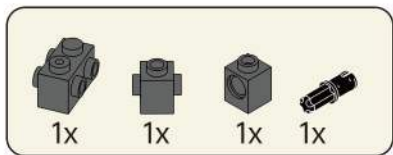
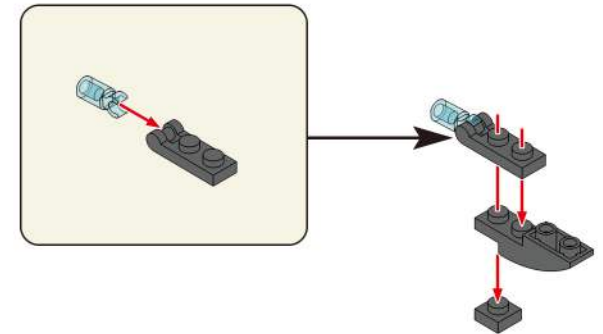

310

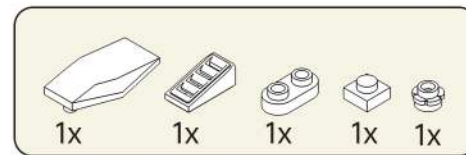
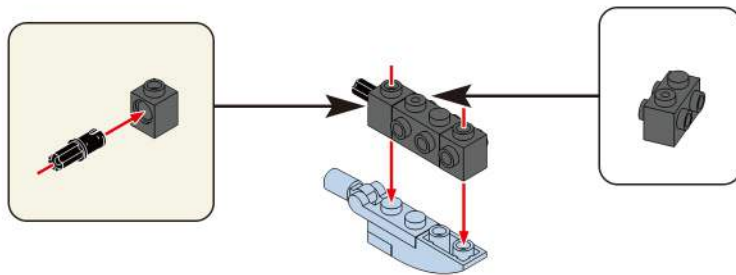

311

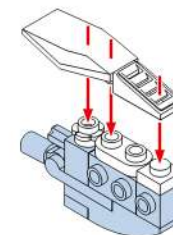

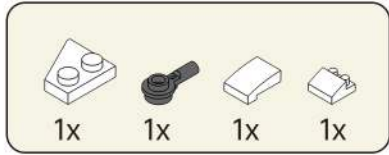

312

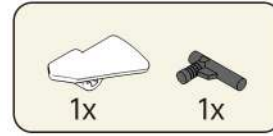
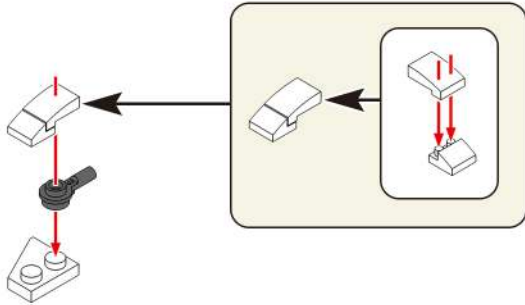

313

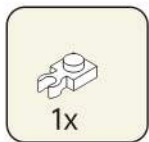
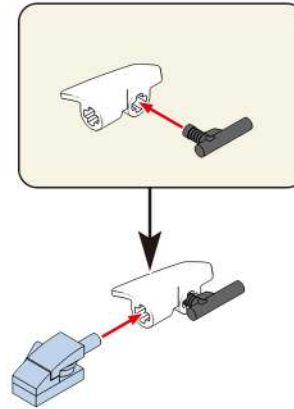

314

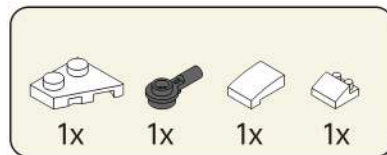
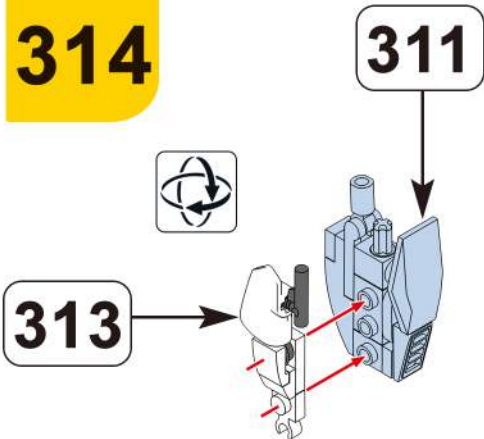

315

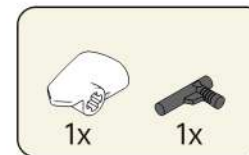
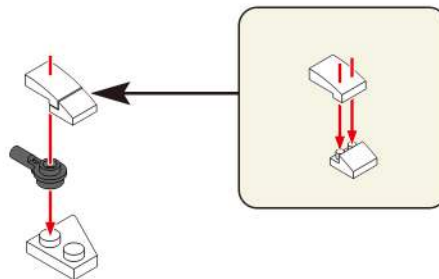

316

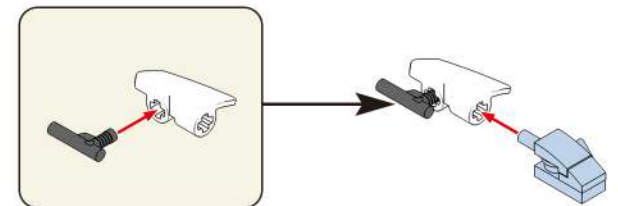

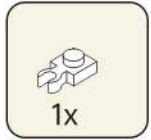

317

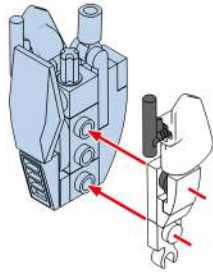

318

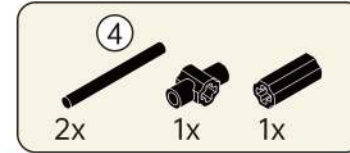
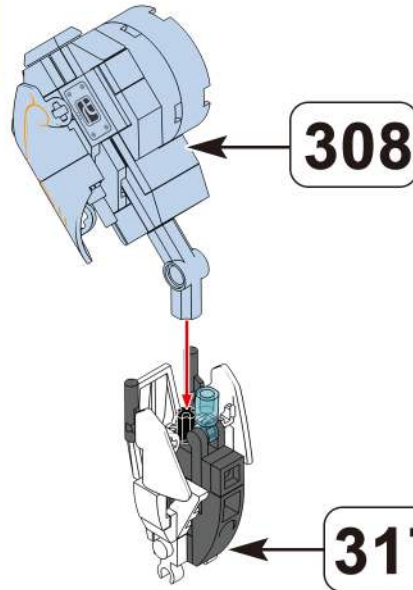

319

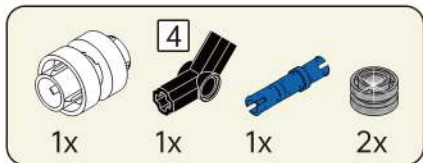
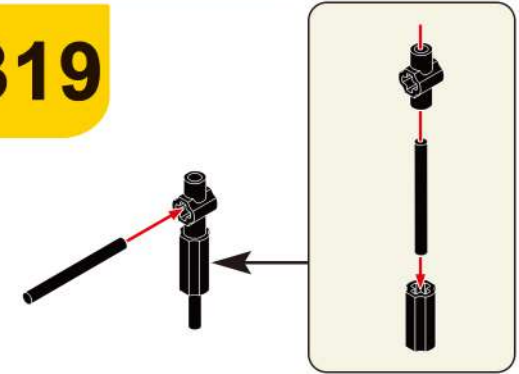

320

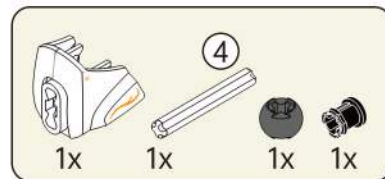
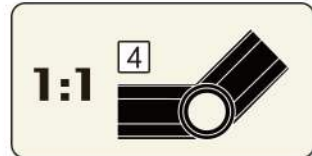
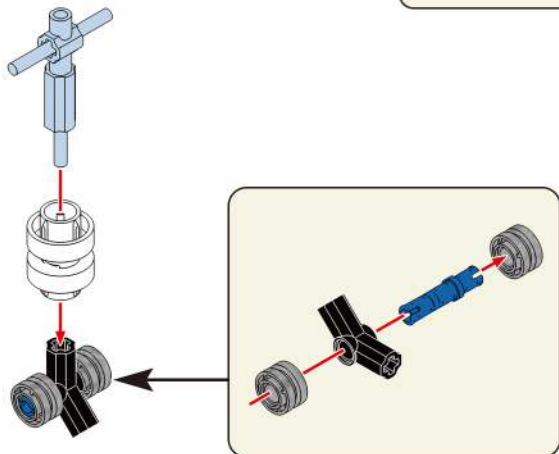

321

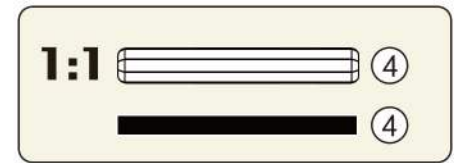
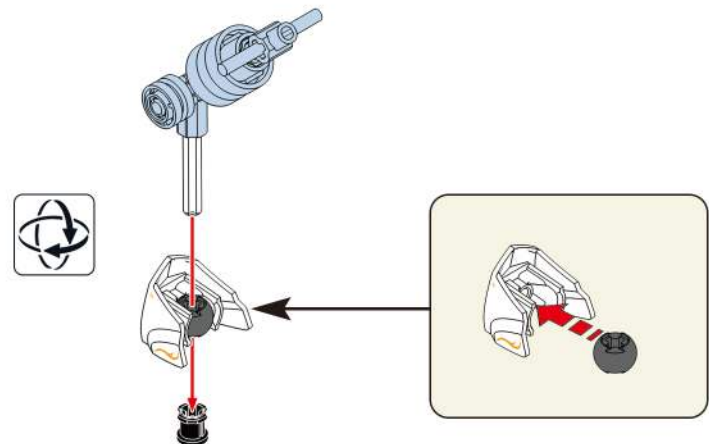

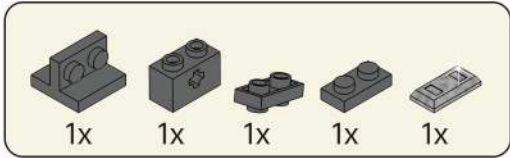

322

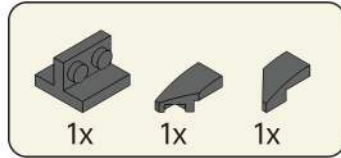
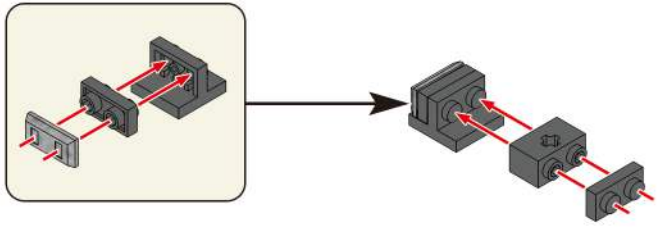

323

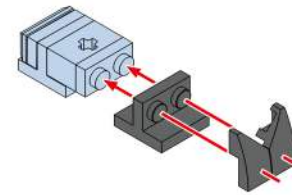

324

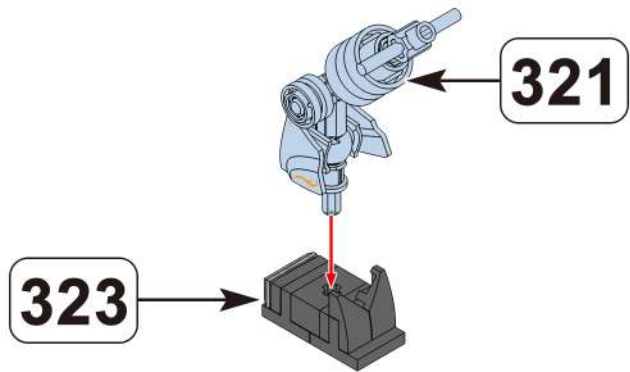

325

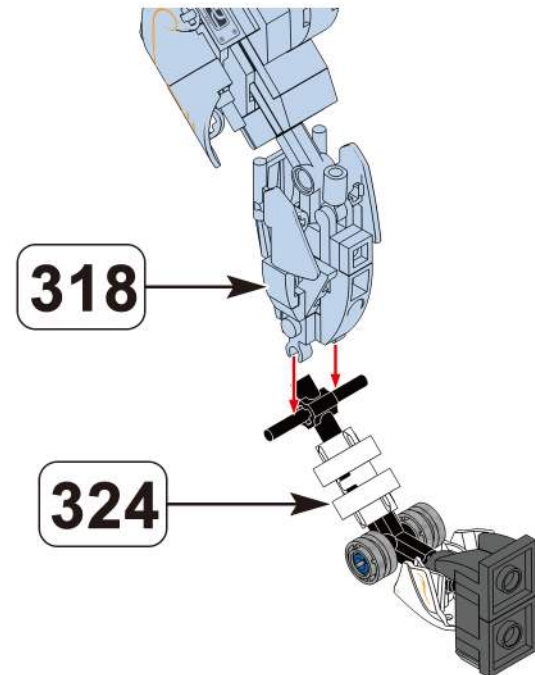

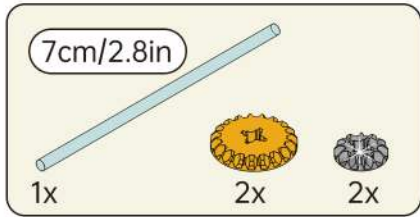

7cm/2.8in

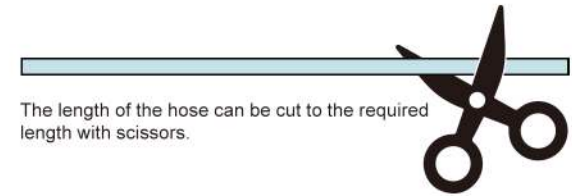
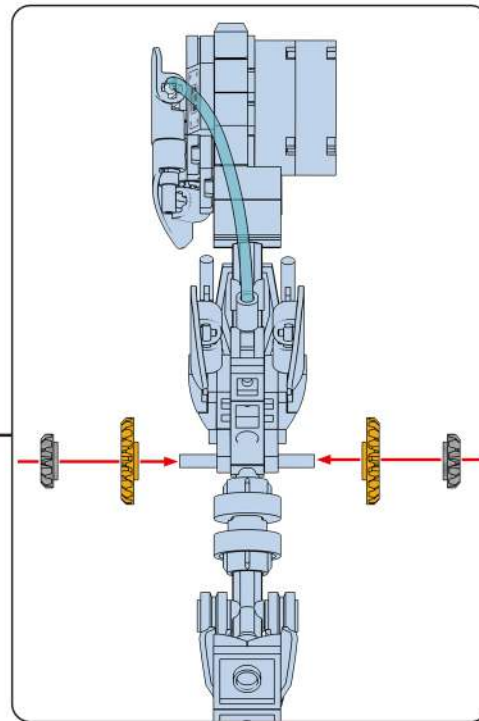
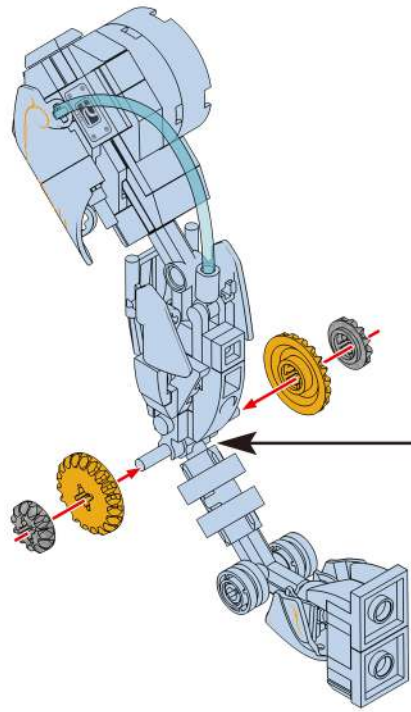

1x 2x 2x

326



1:1  7cm/2.8in

327

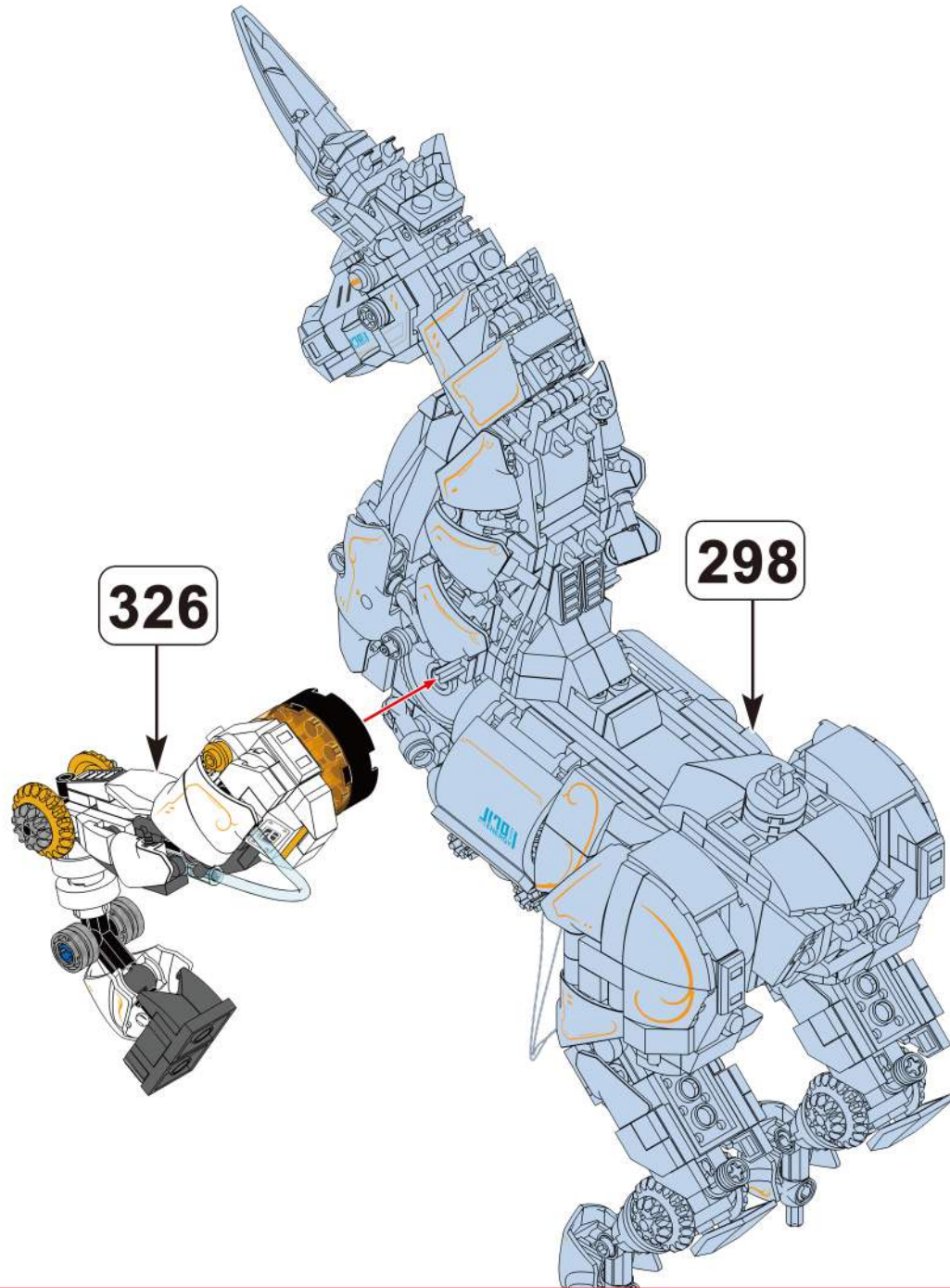

326

298

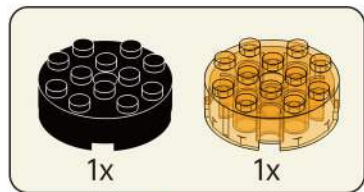

328

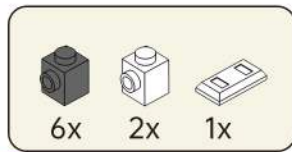
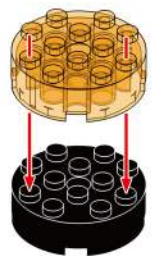

329

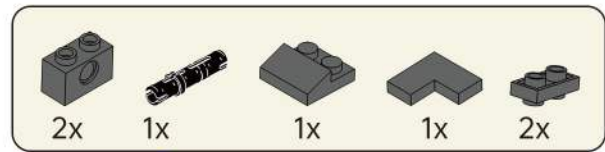
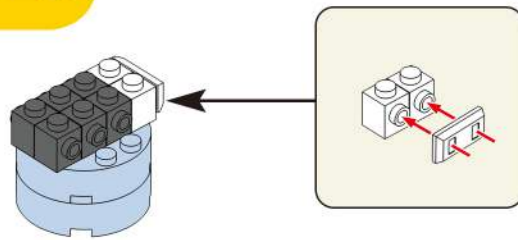

330

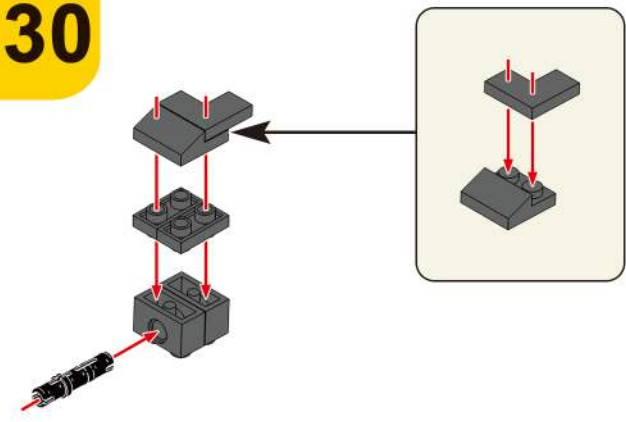

331

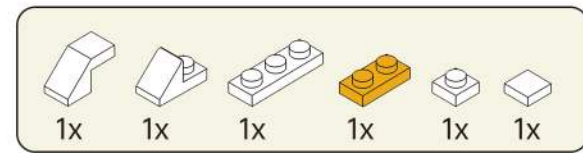
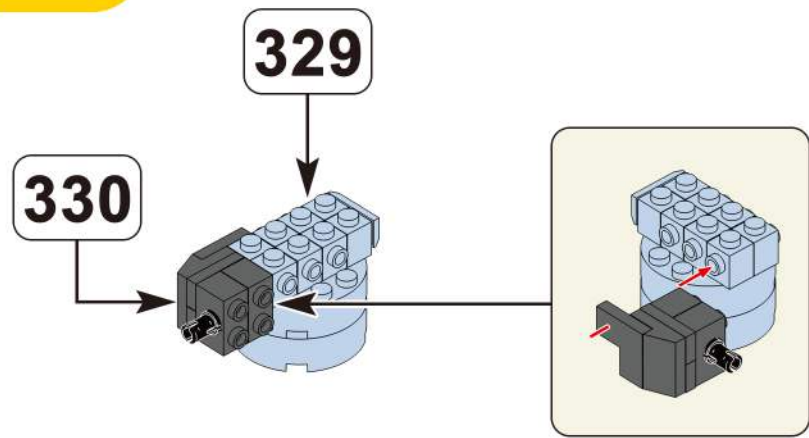

332

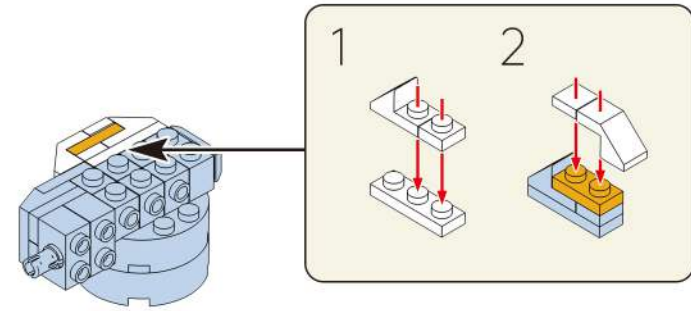

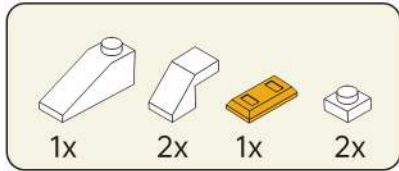

333

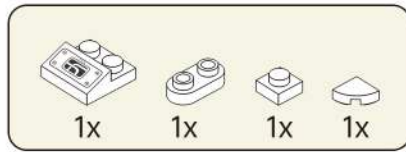
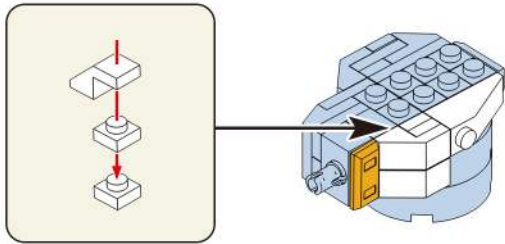

334

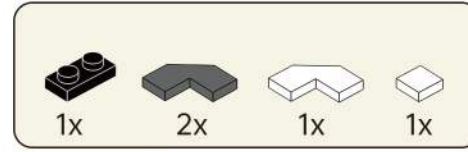
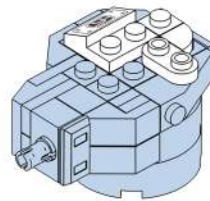

335

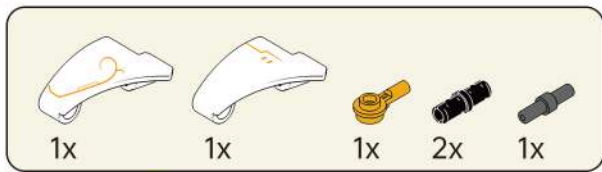
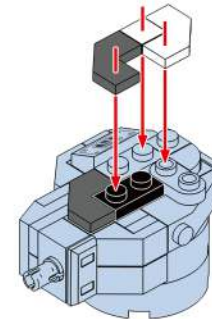

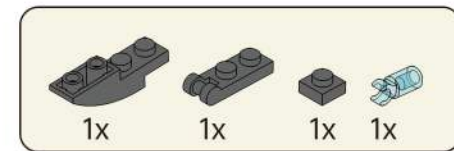
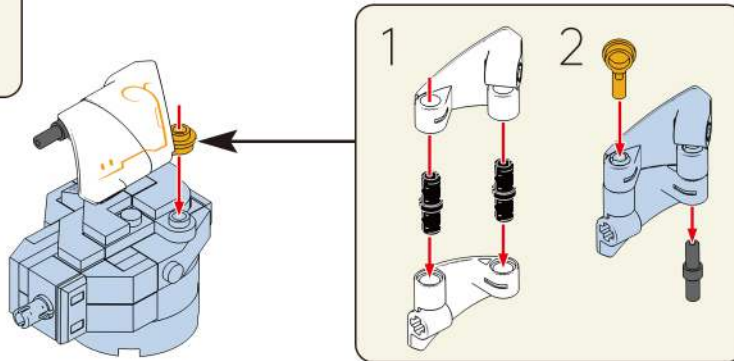

336

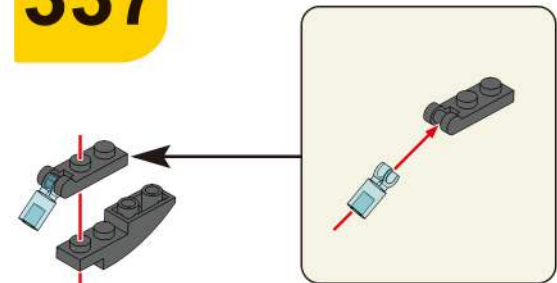

337



The printing accessories for this step, as shown in the diagram, are assembled together and need to be disassembled before installation.

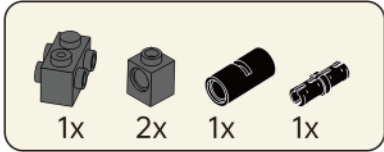

338

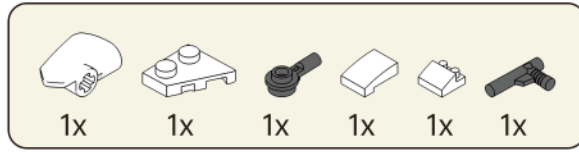
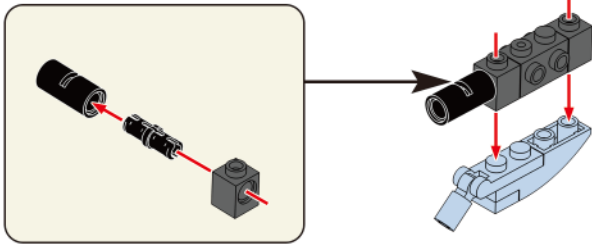

339

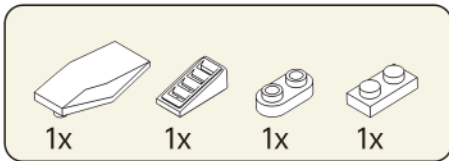
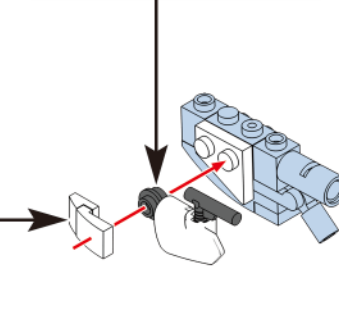
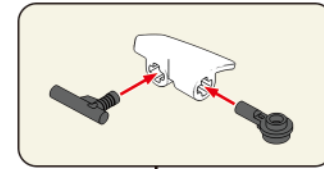
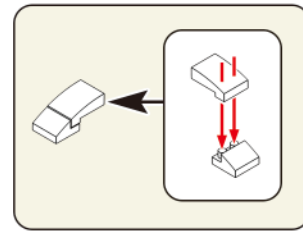

340

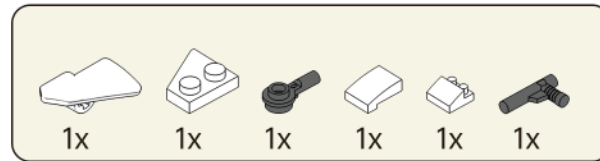
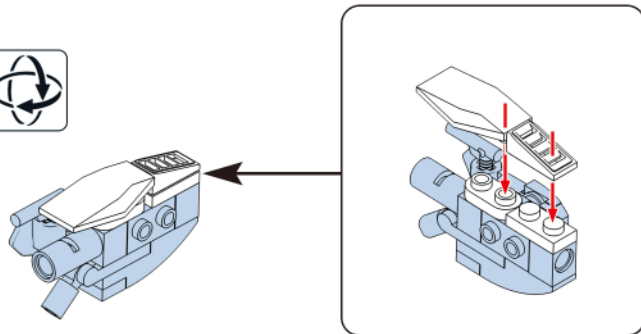

341

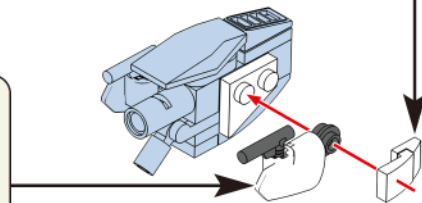
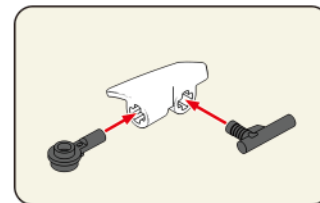
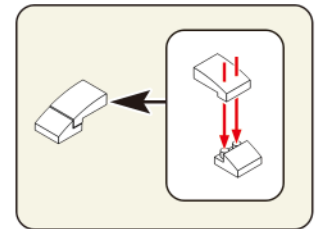

342

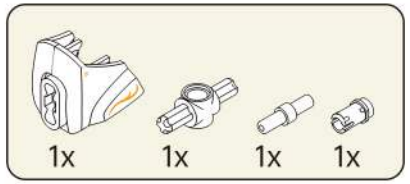
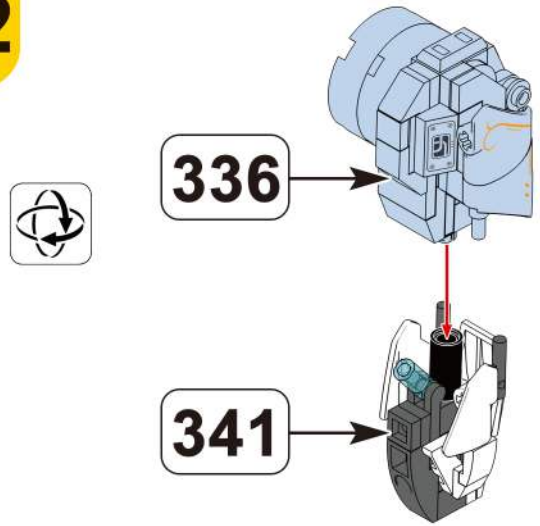

343

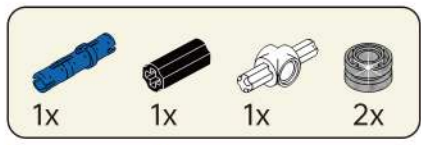
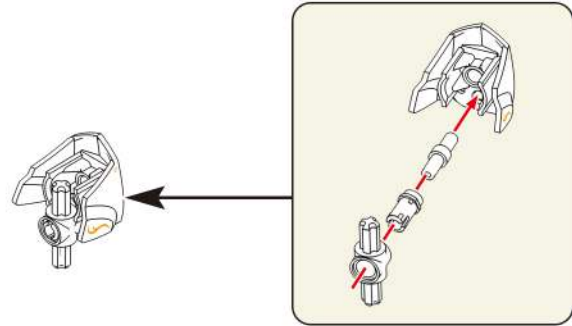

344

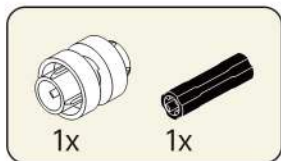
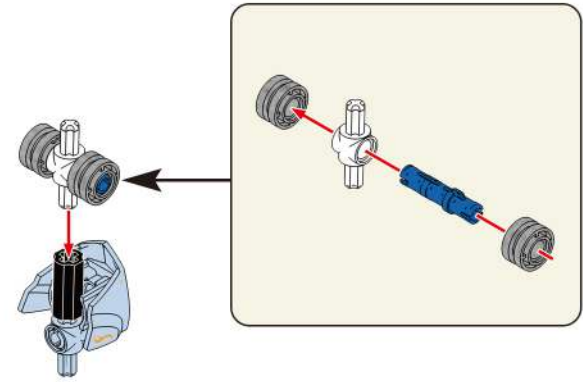

345

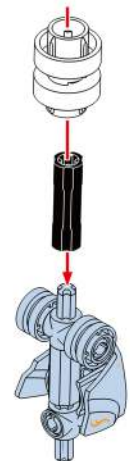

- 1x
 - 1x
 - 2x
- 1.1cm/0.43in

346

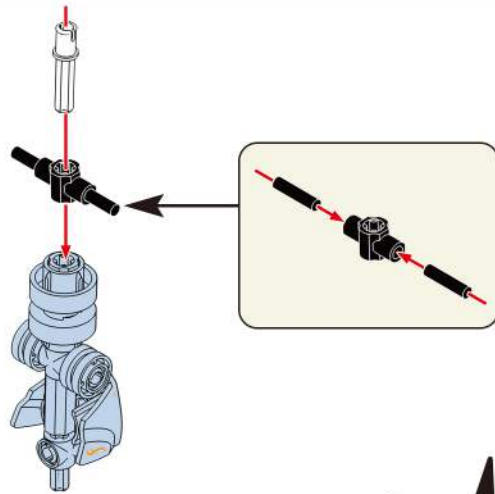

1:1 1.1cm/0.43in

The length of the hose can be cut to the required length with scissors.



- 1x
 - 2x
 - 2x
- 7cm/2.8in

348

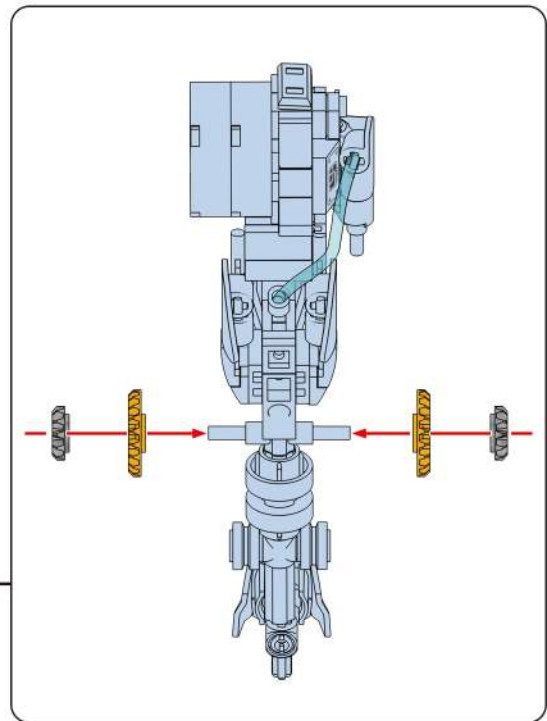
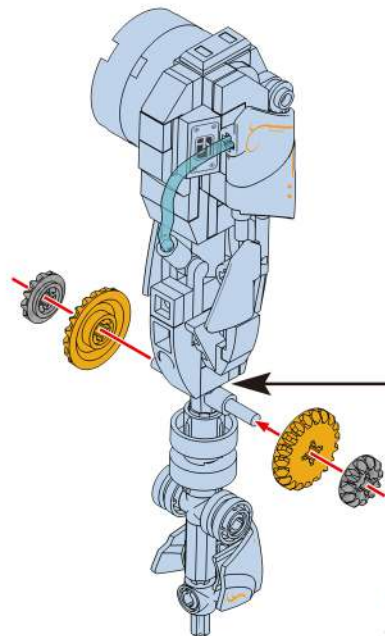

The length of the hose can be cut to the required length with scissors.



347

342



346

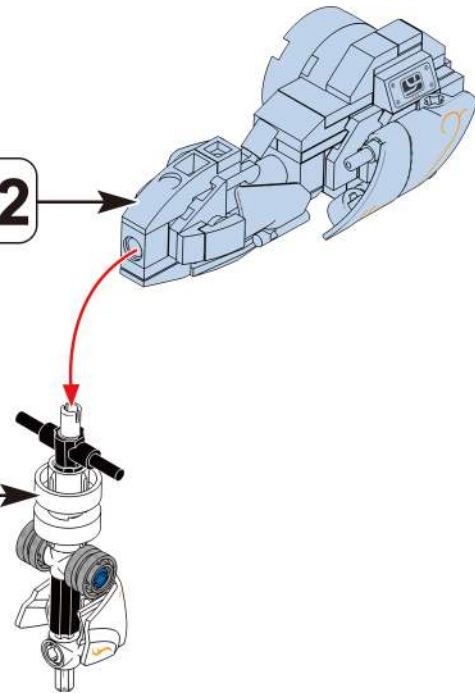

1:1 7cm/2.8in

349

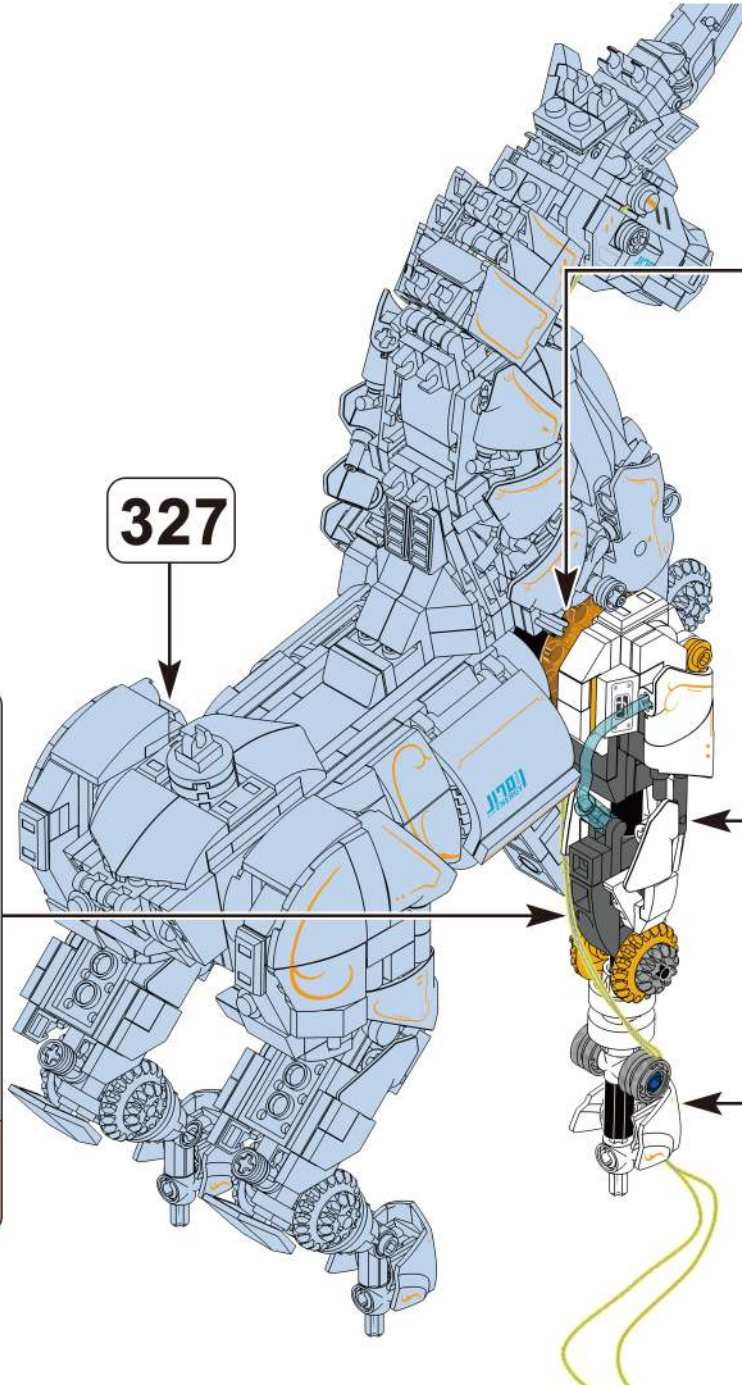
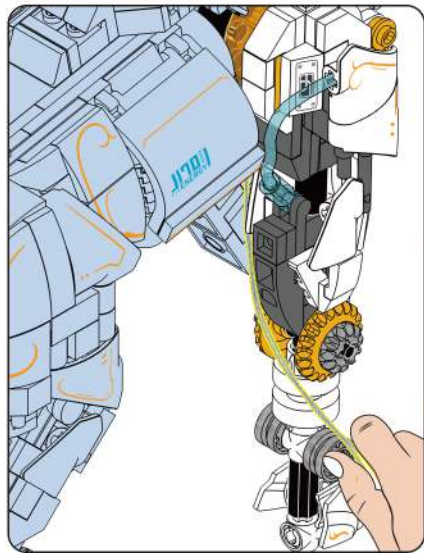

327

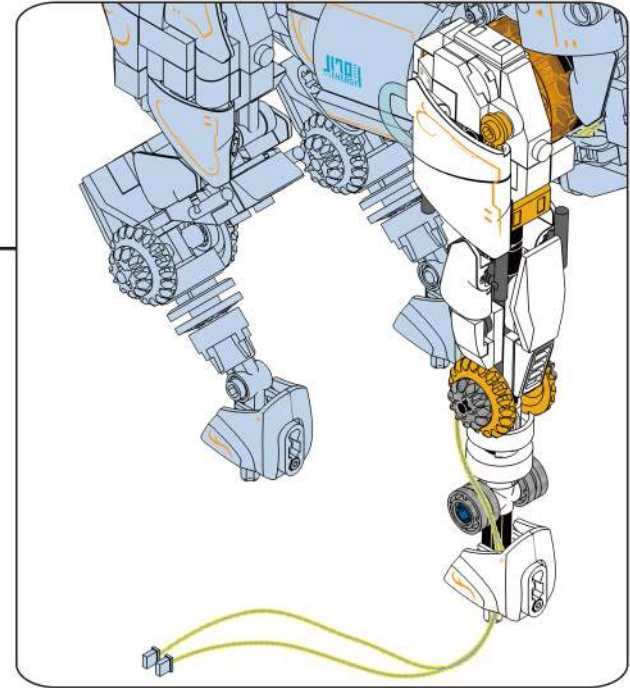

348

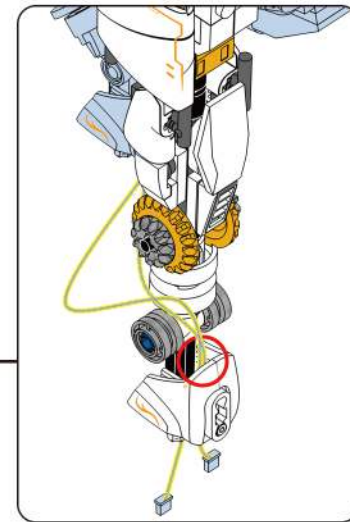

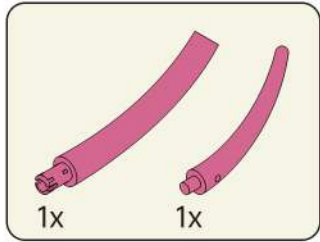

350

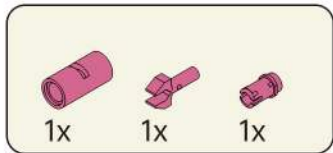
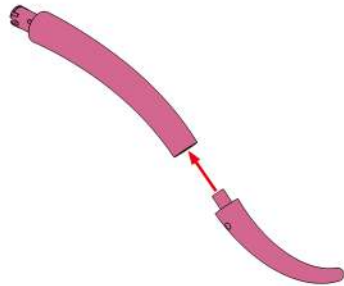

351

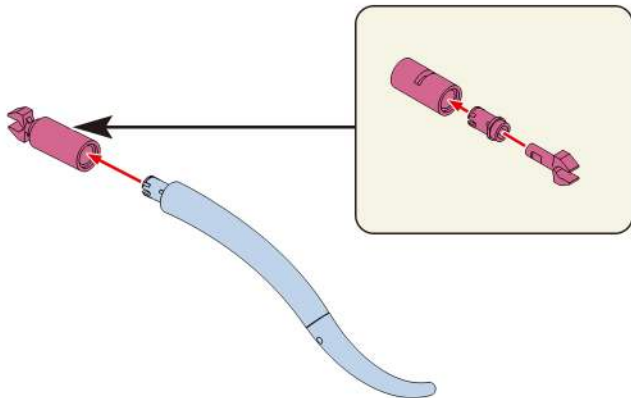

352

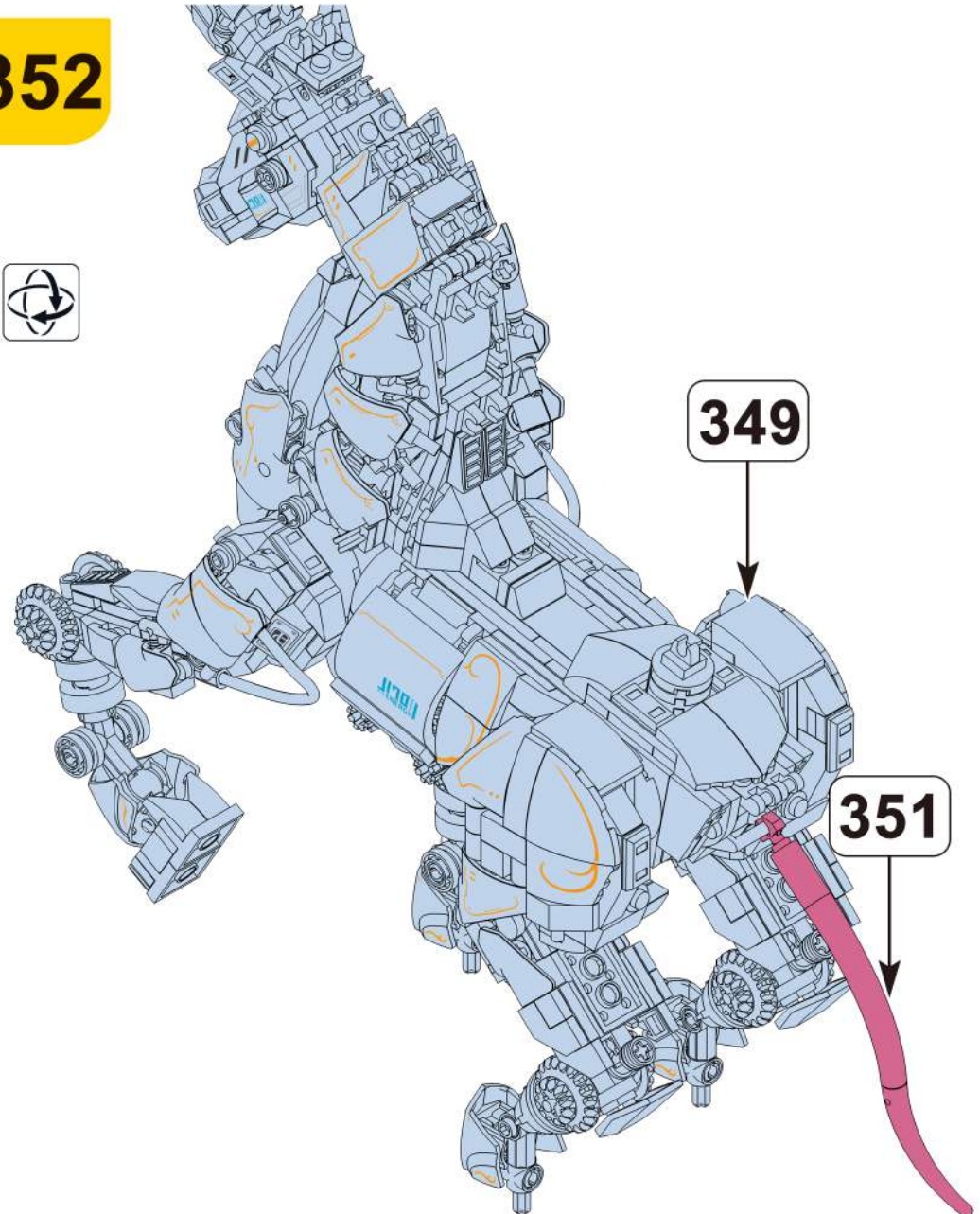

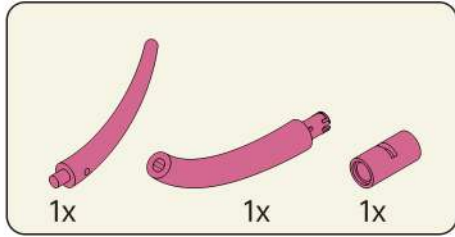

353

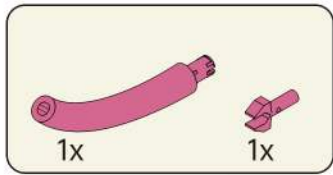
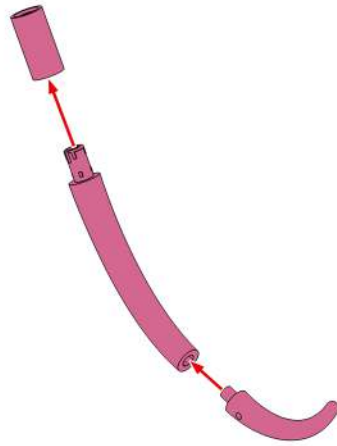

354

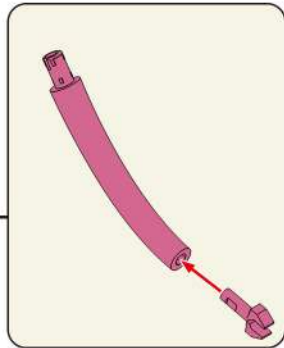
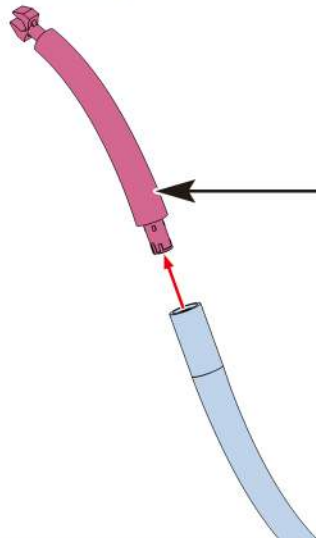

355

352

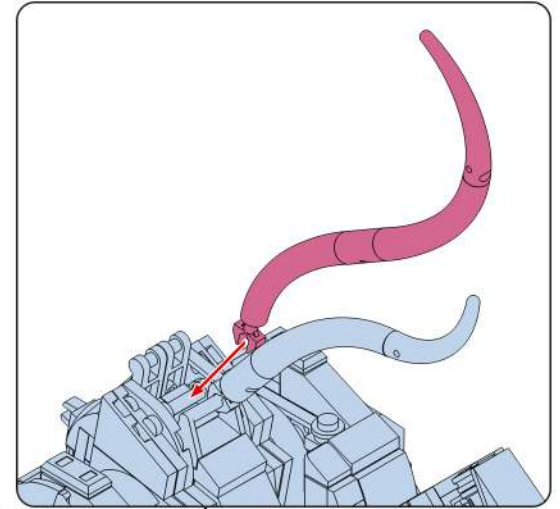

354

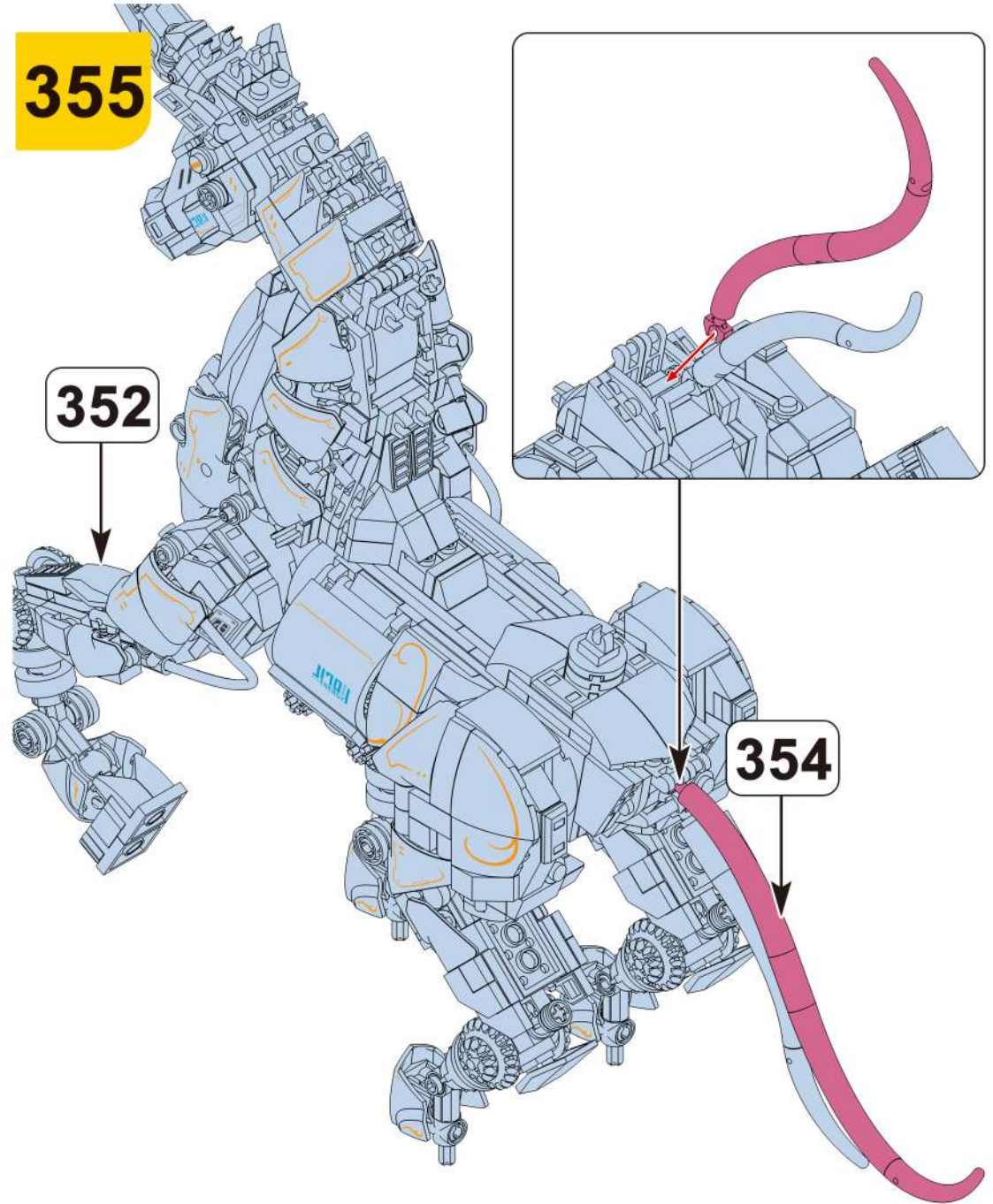

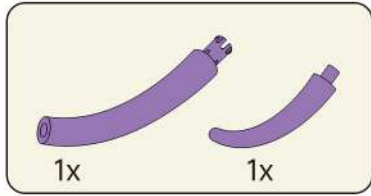

356

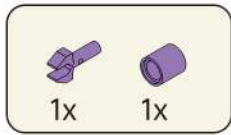
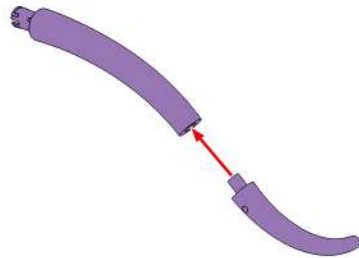

357

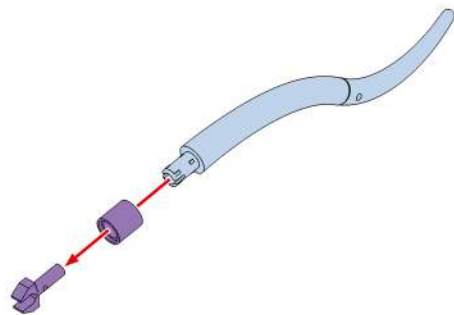

358

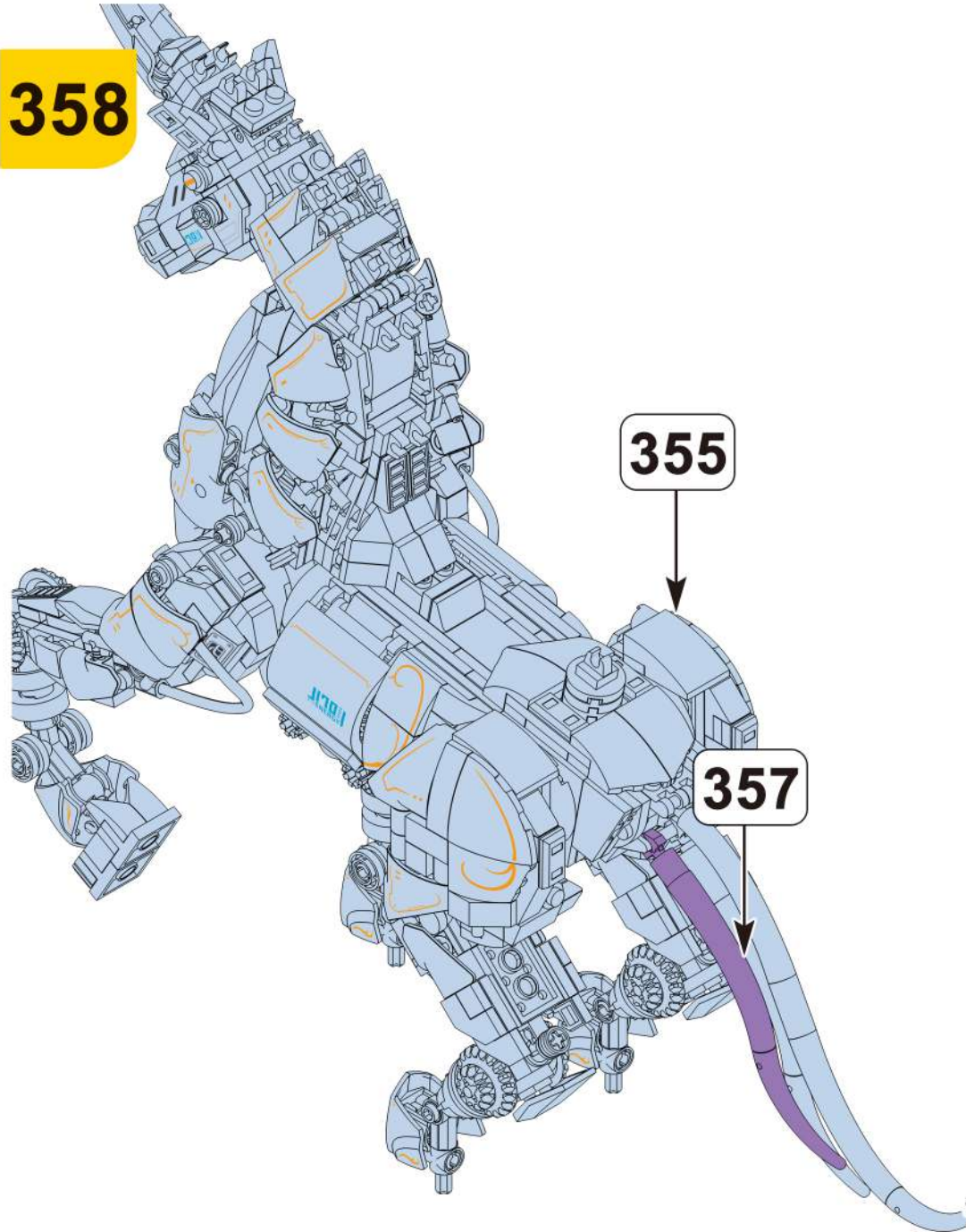

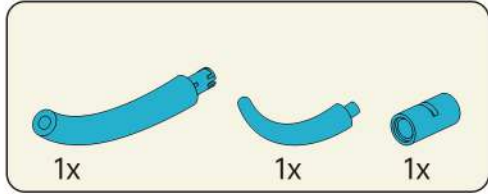

359

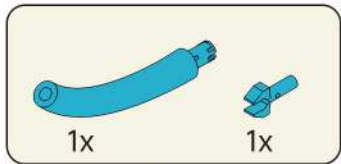
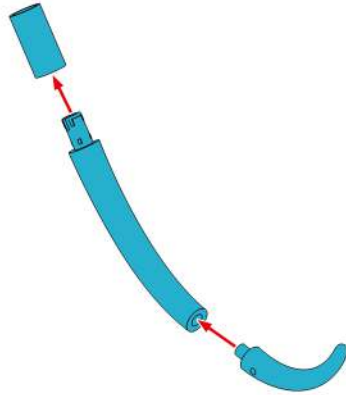

360

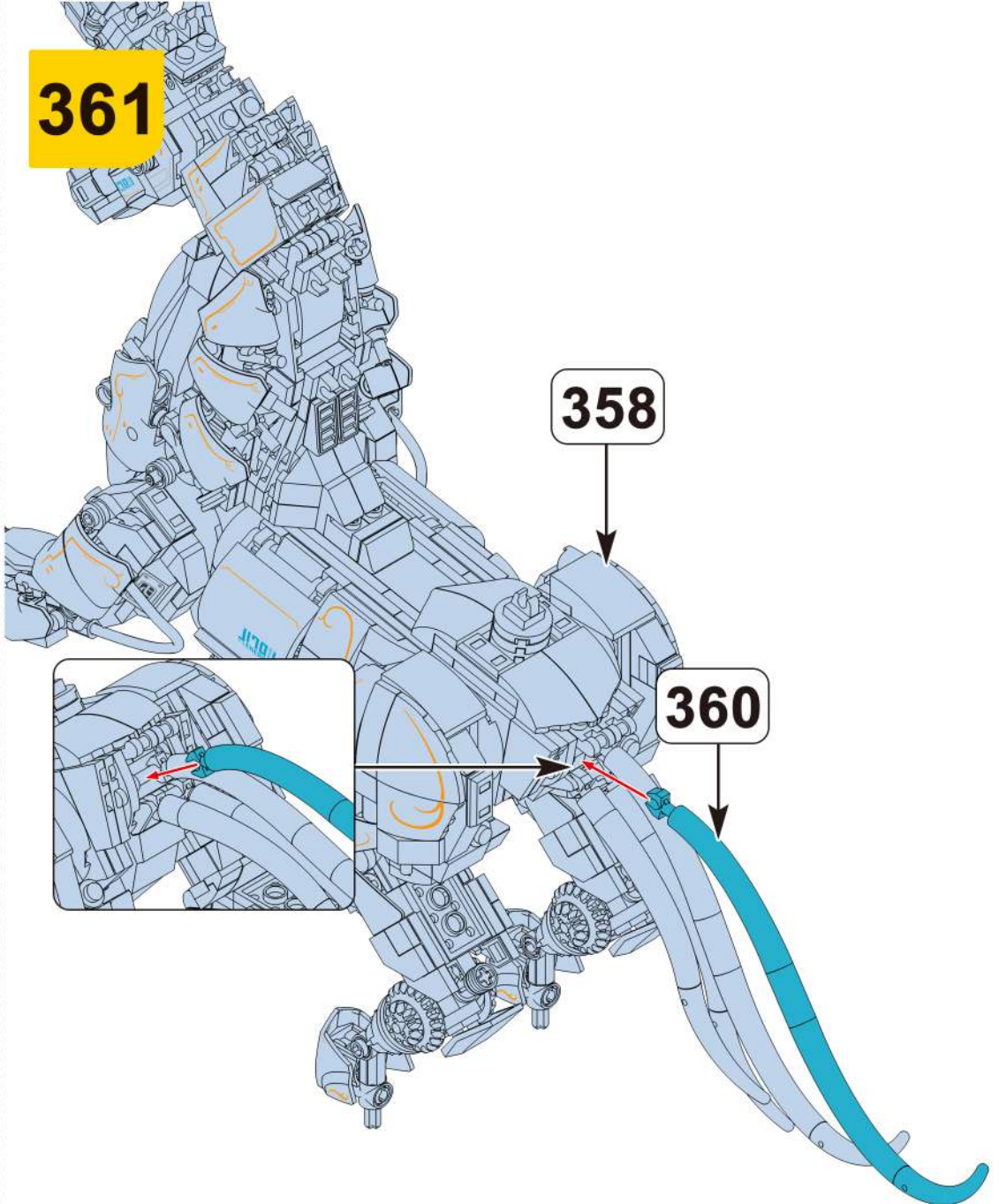
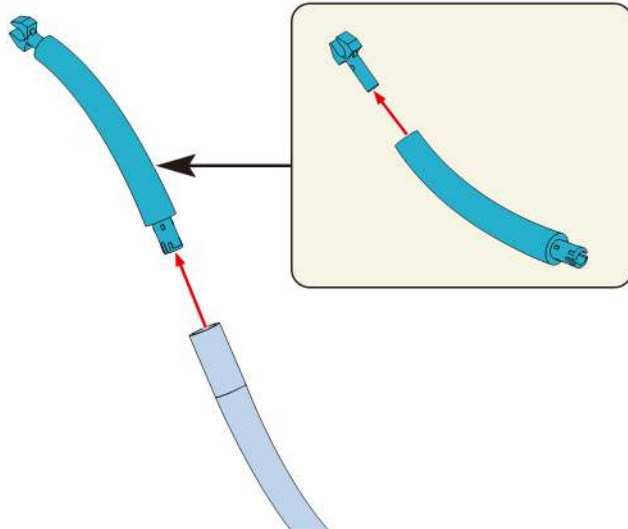

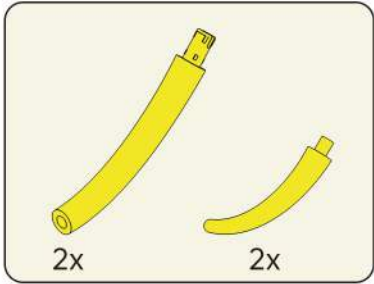

362

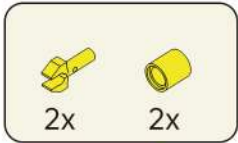
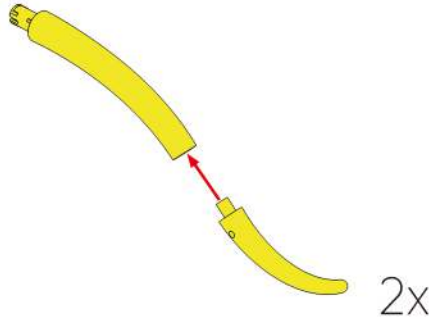

363

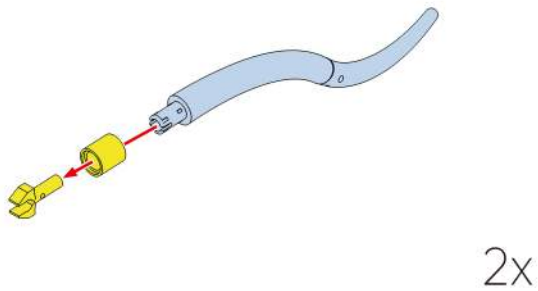

364

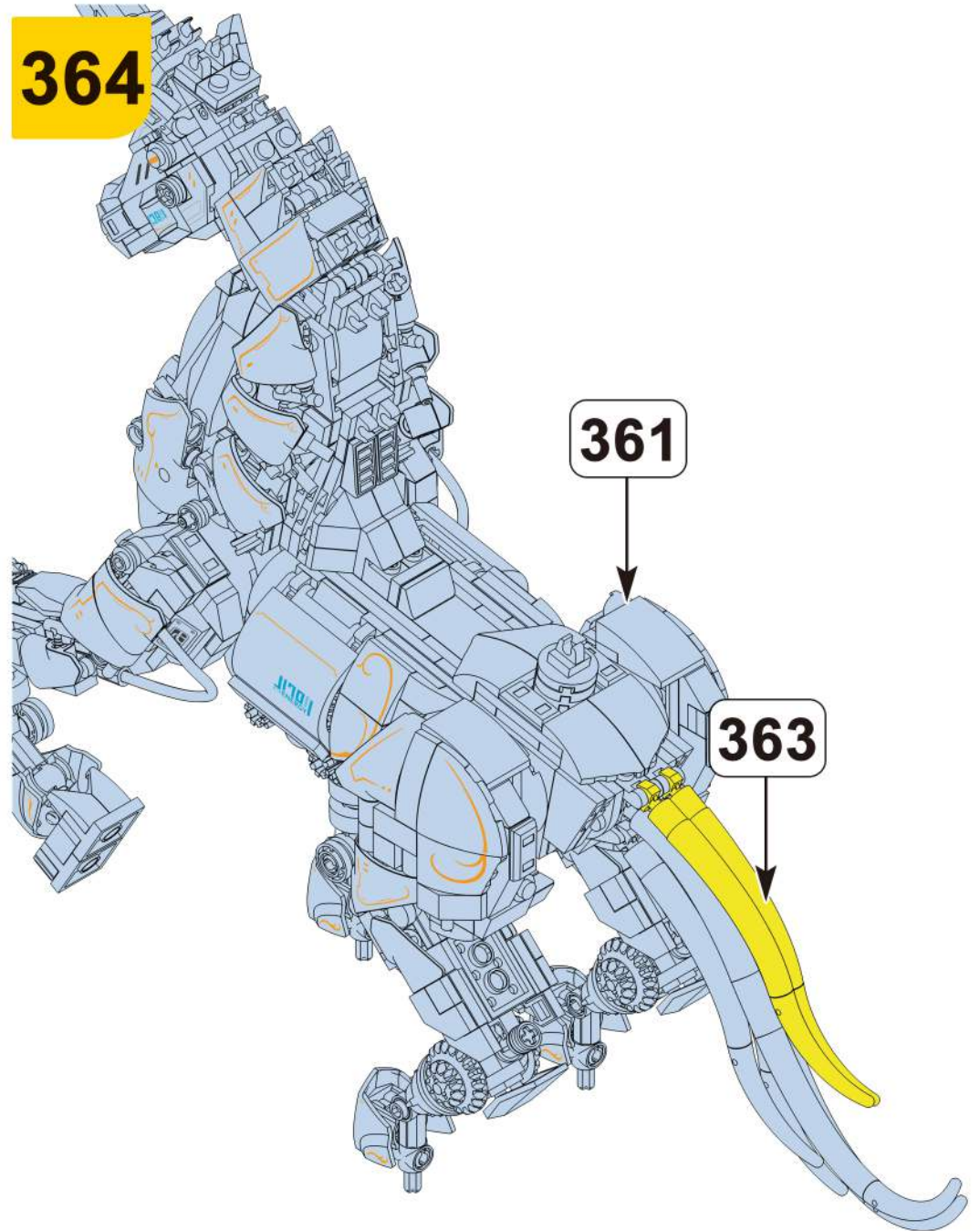

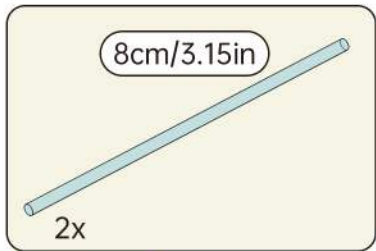

365

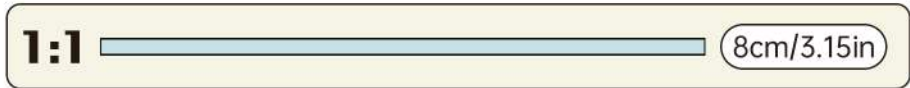
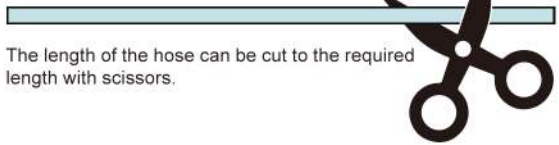
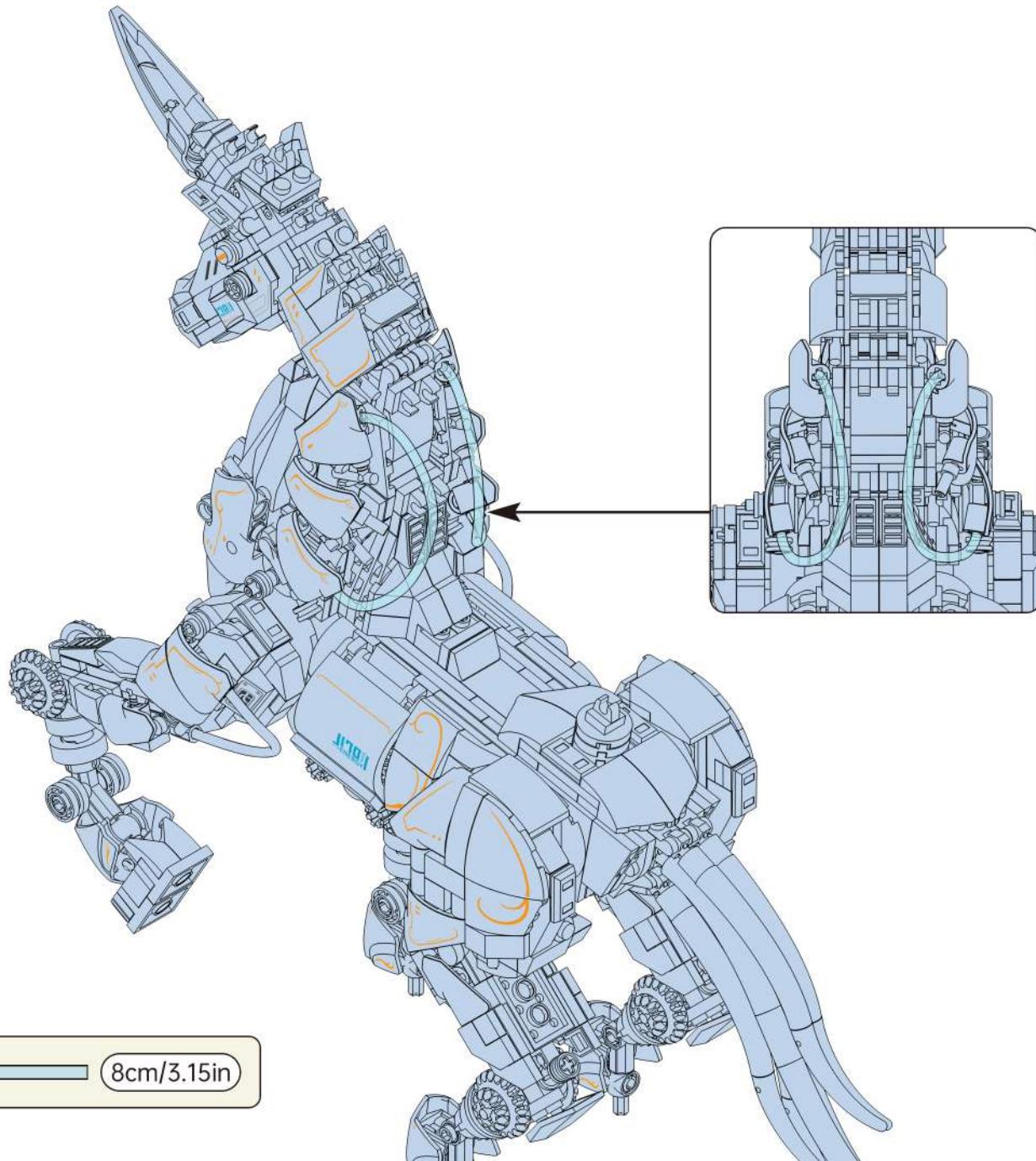

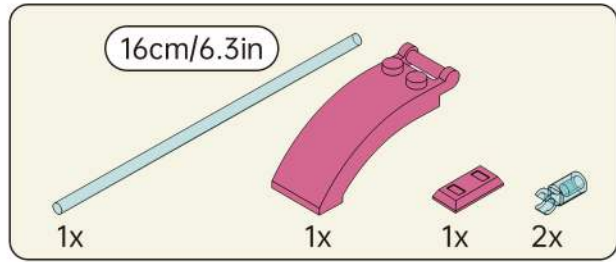

366

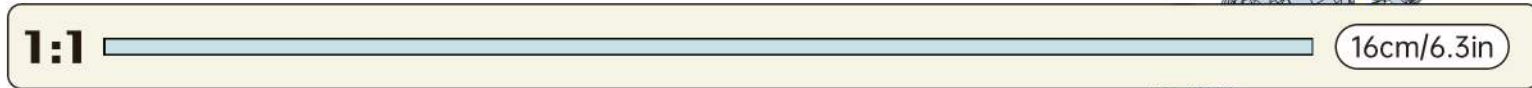
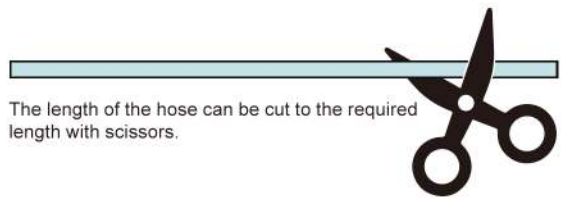
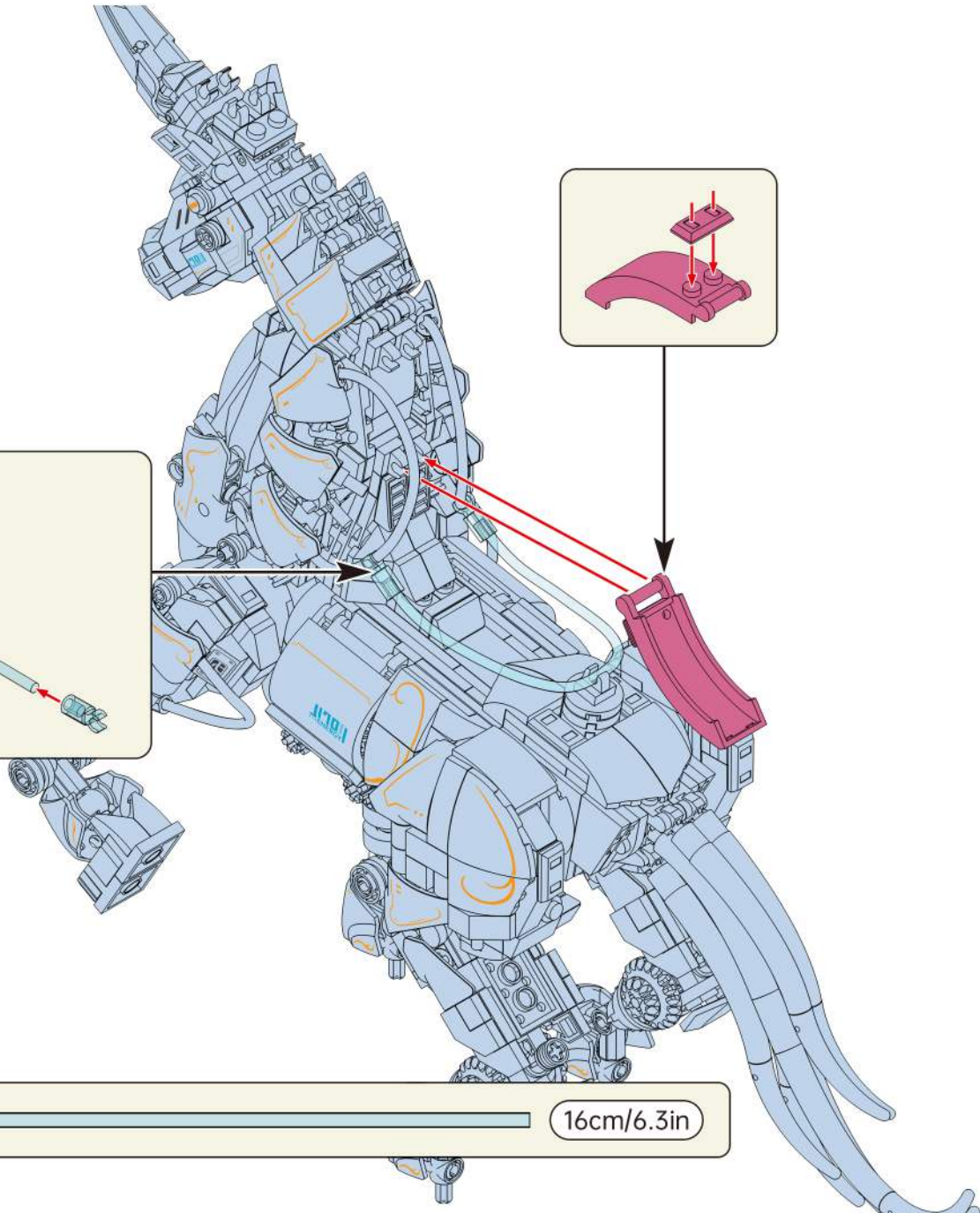
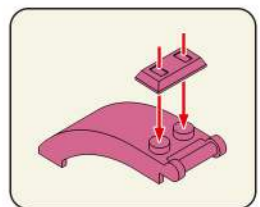
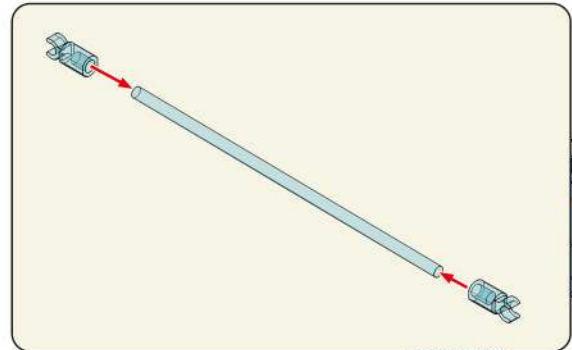

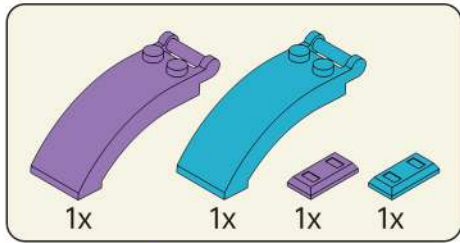

367

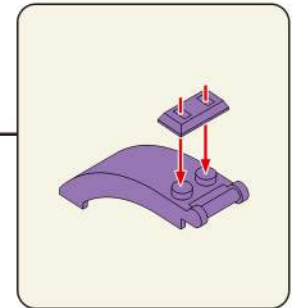
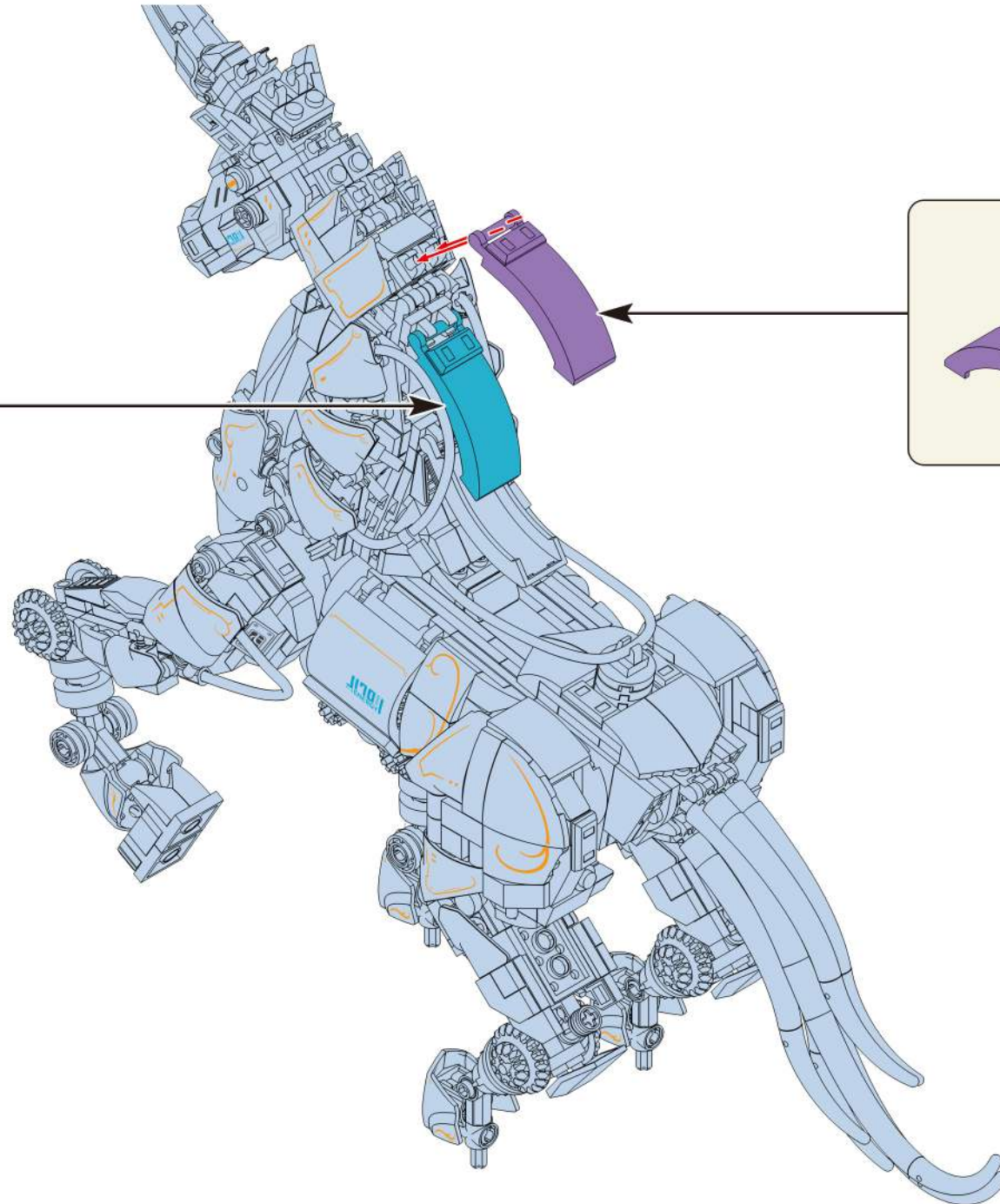
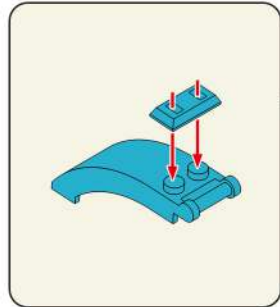

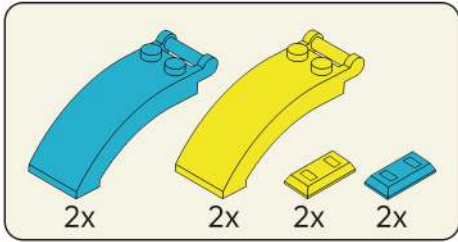

368

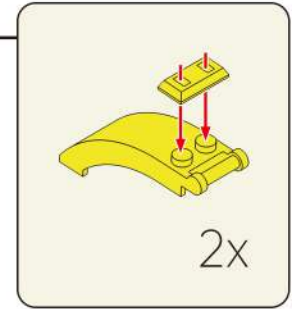
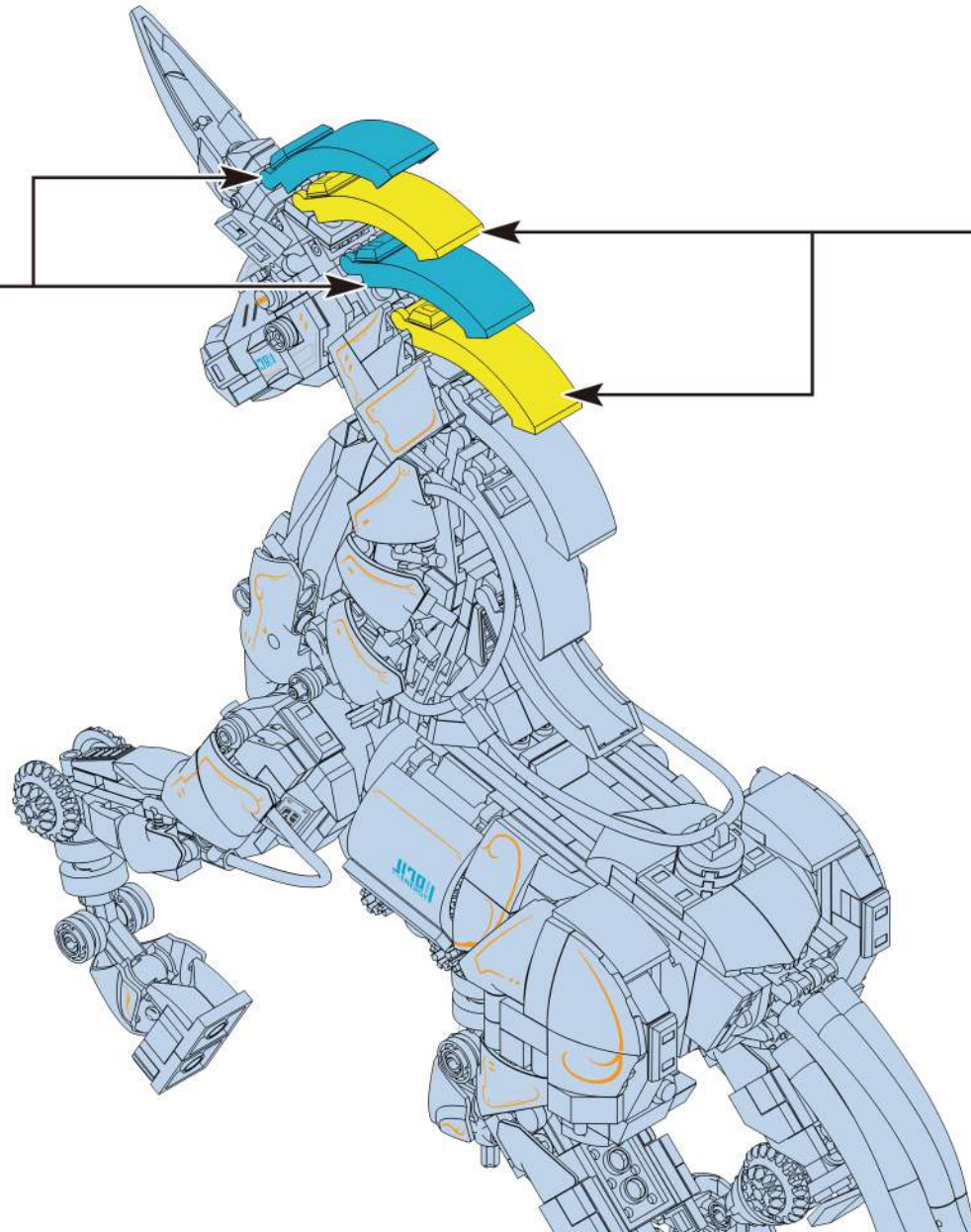
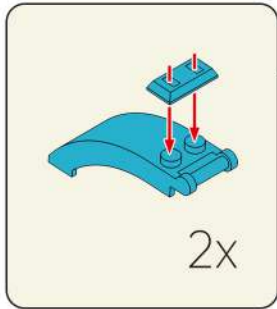

369

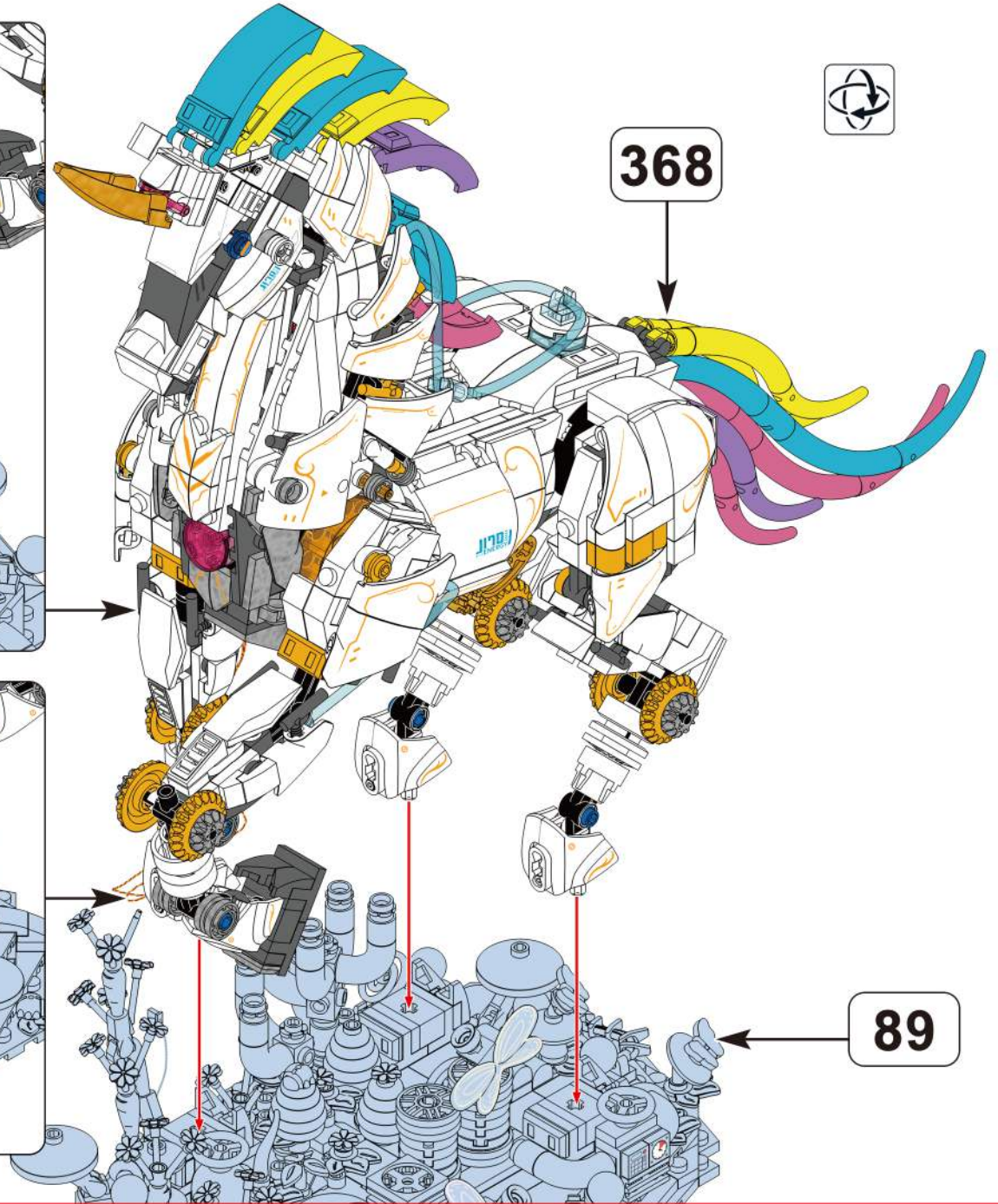
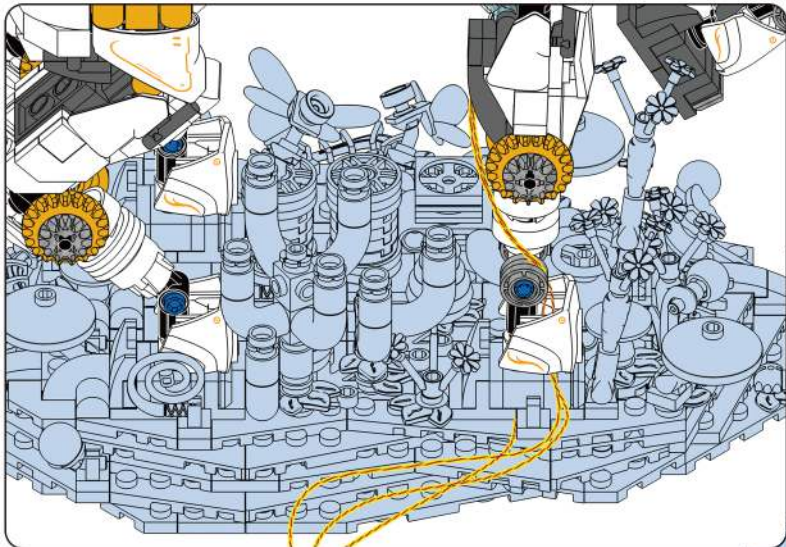
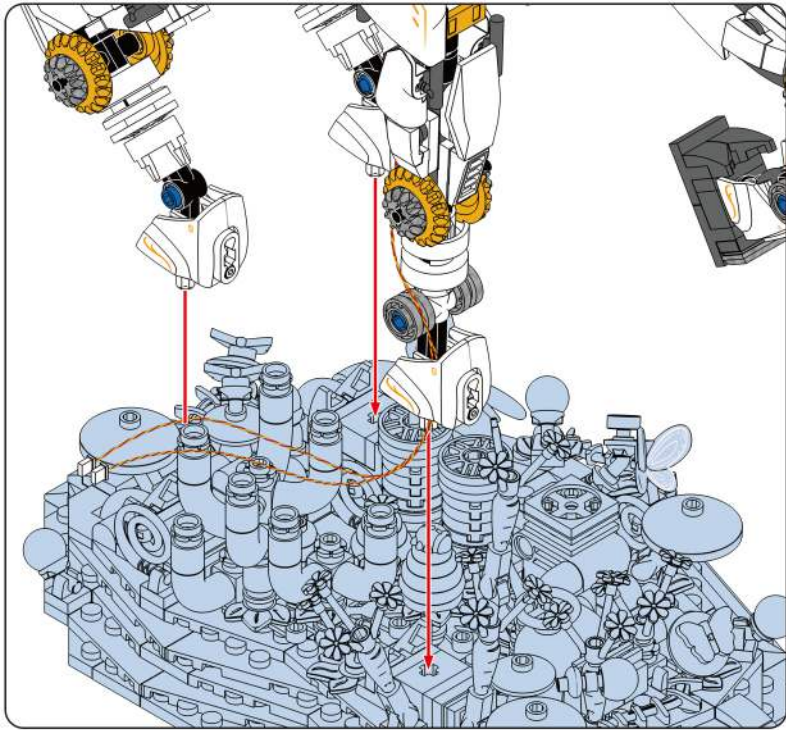

368

89

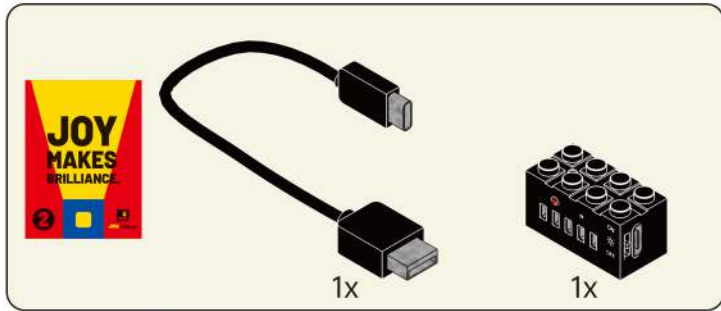

370

Connectors can be inserted into ports of the expansion boards in only one way. Make sure the plug faces the right way before connecting.

Tips: If the plug doesn't fit easily into a port connector, please don't force it. Otherwise, it will damage the plug and connector, and even cause a short circuit. DISCONNECT POWER IMMEDIATELY to avoid dangers.

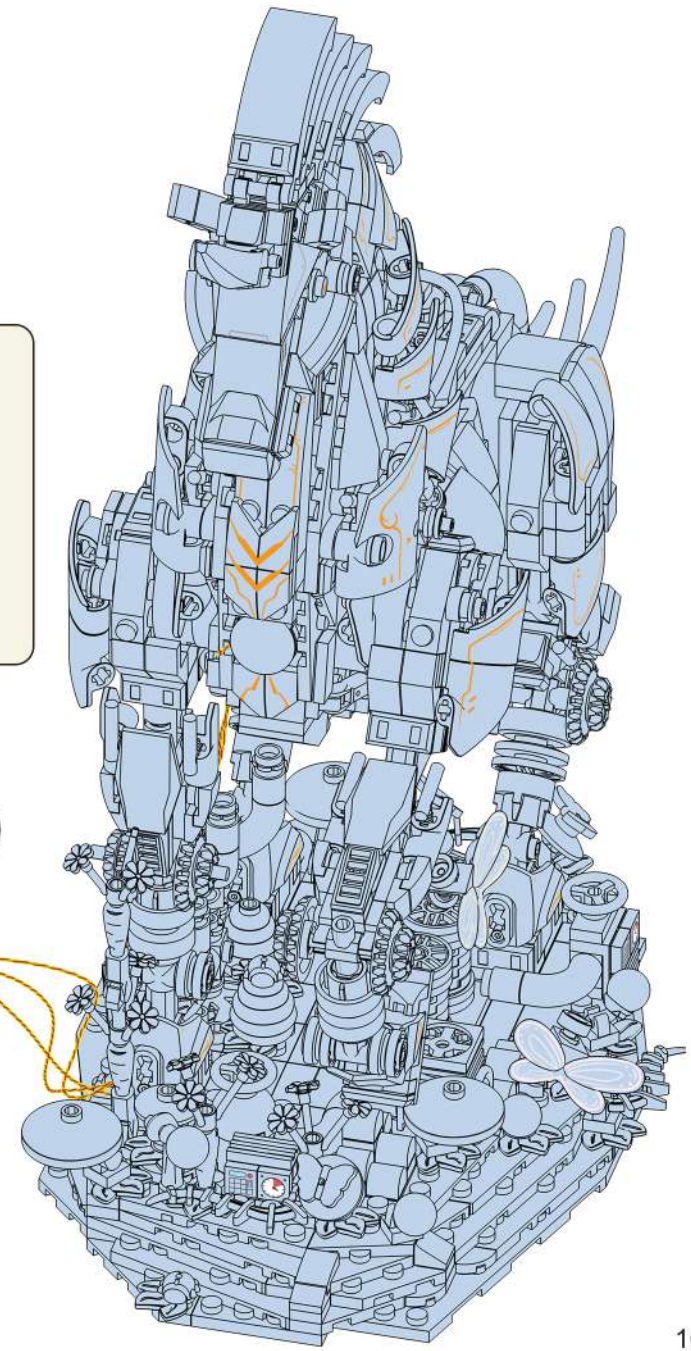
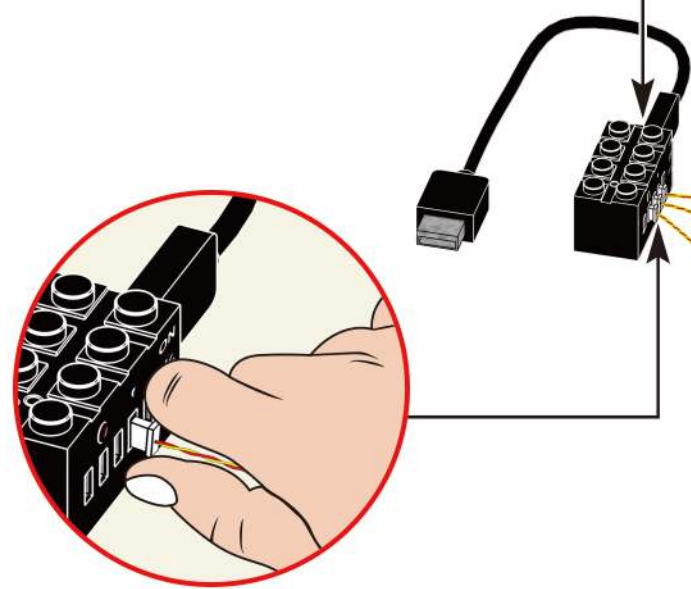
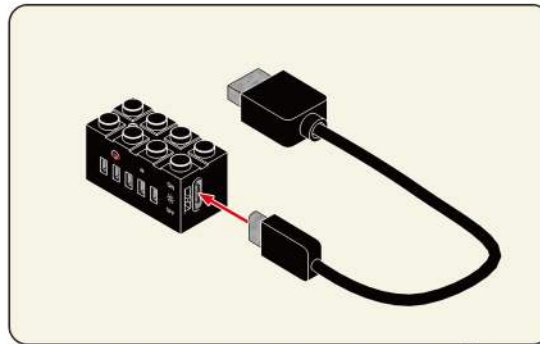

Lighting function display:

ON Constant Light Mode: In this mode, the lights remain continuously illuminated once turned on, providing steady illumination until manually switched off.

***** Light Sensor Mode: This setting activates the light only when ambient lighting is low, automatically turning on during nighttime or in dark conditions and switching off in bright environments, effectively

OFF Power Off: Selecting this option completely disables the device, ensuring no power consumption occurs until manually reactivated by

These three primary functions allow versatile usage scenarios, catering to different needs whether requiring constant illumination, energy-saving automatic operation, or complete shutdown.

Note: When in use, Voltage must be less than 5v. Not for children under eight.

Beleuchtungsfunktionen:

ON Ständige Beleuchtungsmodus: Sobald eingeschaltet, bleiben die Lichter kontinuierlich erleuchtet und bieten eine stabile Beleuchtung bis manuell ausgeschaltet.

***** Lichtsensor Modus: Diese Einstellung aktiviert das Licht nur bei schwacher Umgebungsbewegung, schaltet es automatisch in der Nacht oder in dunklen Bedingungen ein und in hellen Umgebungen aus, was effektiv Strom spart.

OFF Ausschalten: Die Auswahl dieser Option deaktiviert das Gerät vollständig, wodurch kein Stromverbrauch auftritt, bis durch den Benutzer manuell erneut aktiviert.

Diese drei Hauptfunktionen ermöglichen vielseitige Szenarien, die unterschiedliche Anforderungen abdecken, sei es konstante Beleuchtung, energieeffiziente automatische Betrieb oder vollständiges

Hinweis: Beim Einsatz muss die Spannung kleiner als 5V sein. Nicht für Kinder unter acht Jahren geeignet.

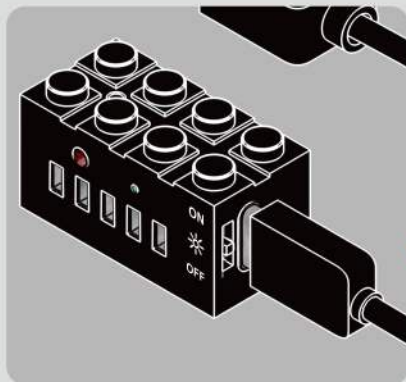
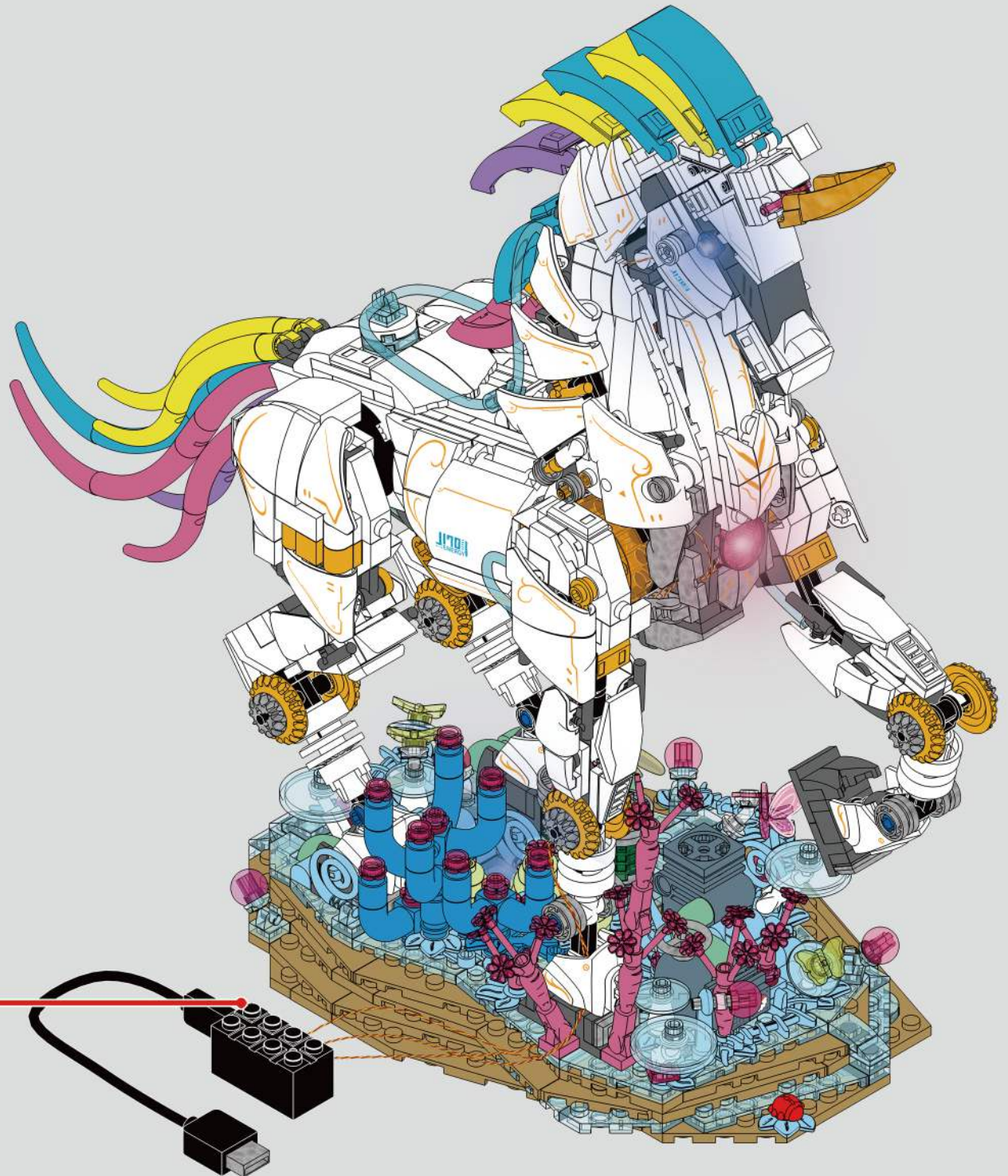

JOY MAKES BRILLIANCE.

Embrace Relaxation Embrace Joy

Every adultescent needs a "JOY BOX".
Please , open your JOY BOX ! Heading for joy.



14+
AGES



Thank you for choosing our JMB product.
We would like to hear your thoughts on the new product you
have just purchased. Your feedback will help shape the future
development of this product line.
You can contact us at <http://www.jmbricklayer.com> or via
email at Service@jmbricklayer.com.

Vielen Dank, dass Sie unser JMB Produkt ausgewählt haben.
Wir möchten Ihre Meinung zum gerade erworbenen neuen
Produkt hören. Ihr Feedback wird dazu beitragen, die zukünftige
Entwicklung dieser Produktsreihe zu gestalten.
Kontaktieren Sie uns über www.jmbricklayer.com oder per
E-Mail an Service@jmbricklayer.com.

BRICK IT HAPPEN



70011
Mechanical Hummingbird



70016
Impression Sunrise



70004
Botanical Collection The Sunflower



70009
Space Telescope



70010
Swimming Jellyfish



50001
Vintage Car Model A Deluxe Coupe



50002
Western Train Station Bookend



10001
Botanical Collection Succulent Set



70017
Phoenix Nirvana



Dear valued customer,
We sincerely hope you enjoy the product and we can't wait to see you again soon. Please let us know if we can do anything else to help! If you are pleased with your purchase and plan to buy from us again, we have a special offer just for you. When making your payment, please utilize the exclusive discount code "JMBVIP28A6" to avail yourself of a generous 20% discount.

14+
AGES

Long-term Effective
20% OFF
Discount Code
JMBVIP28A6

Available on www.jmbricklayer.com
Online store Support: Support@jmbricklayer.com

BRICK IT HAPPEN



40002
Age of Exploration The Black Pearl



40001
Ghost Ship The Flying Dutchman



70006
Space Planet Station



70007
Cloud Surfing Dragon



70003
Dinosaur Factory



JM Bricklayer



Embrace Relaxation Embrace Joy

Every adultescent needs a "JOY BOX".
Please , open your JOY BOX ! Heading for joy.