

未及 WeKKi

地基足够稳,全靠这一本

搬砖不仔细,重建两行泪

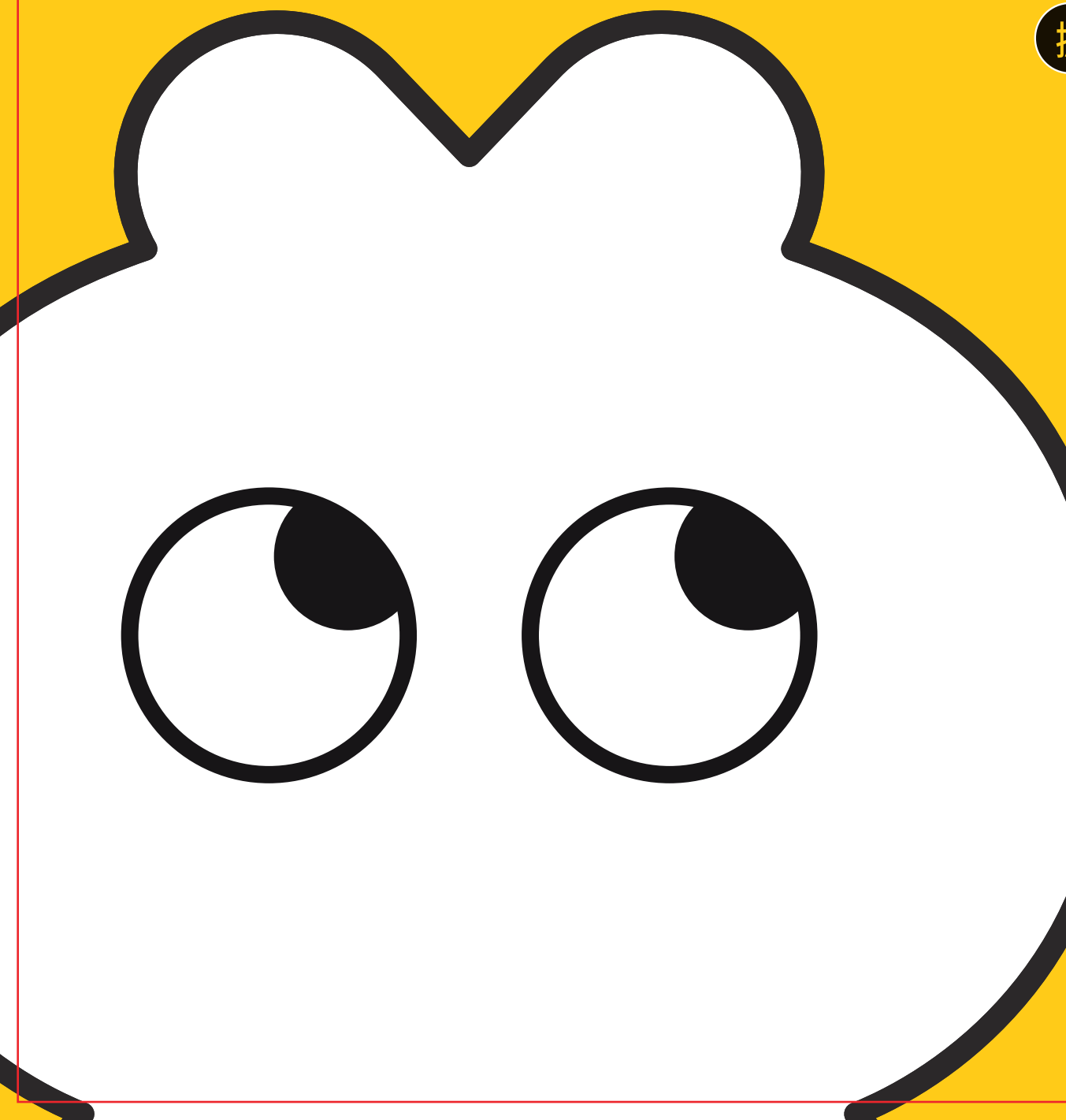

STAREXPLORE PROGRAM

探星计划

人类为了寻找新的类地行星，为此建立的一座观测基地。在迁星计划顺利实施后，承担着观测计划进度、维系行星与地球之间联络的重要任务。

相关阅读

迁星计划 >>>>

PLANET
IMMIGRATION
PLAN

随着人类科学技术的进步，太空探索进入全新阶段，并观测到一颗从未被发现的疑似类地行星。为了揭开这颗星球的神秘面纱，国家派出科考队前往研究，在其内部建立一座科研基地。

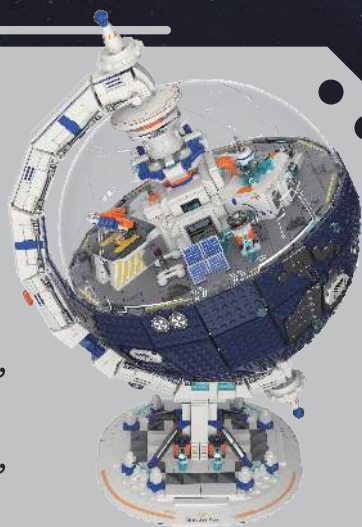

科技馆系列



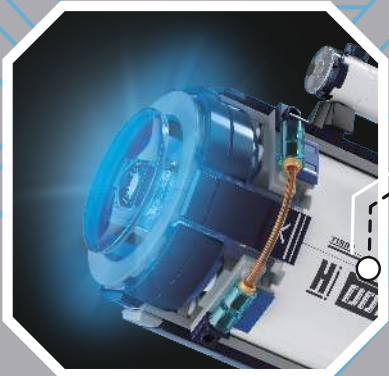

天文望远镜主体

负责实时观测天体
监测任务进行时
镜面会亮起蓝光

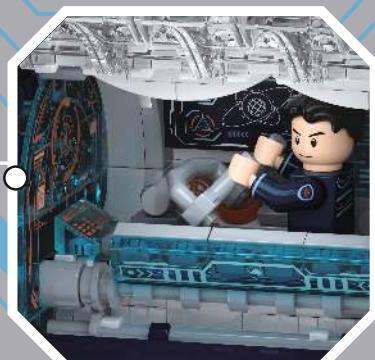

观测操作仓

操作仓开启
工作人员可进仓操作



基地平台区域

天文望远镜监测完成后
将信息上传至基地
完成数据收集及分析



奠基纪念铭牌

探星计划专属
更具收藏意义

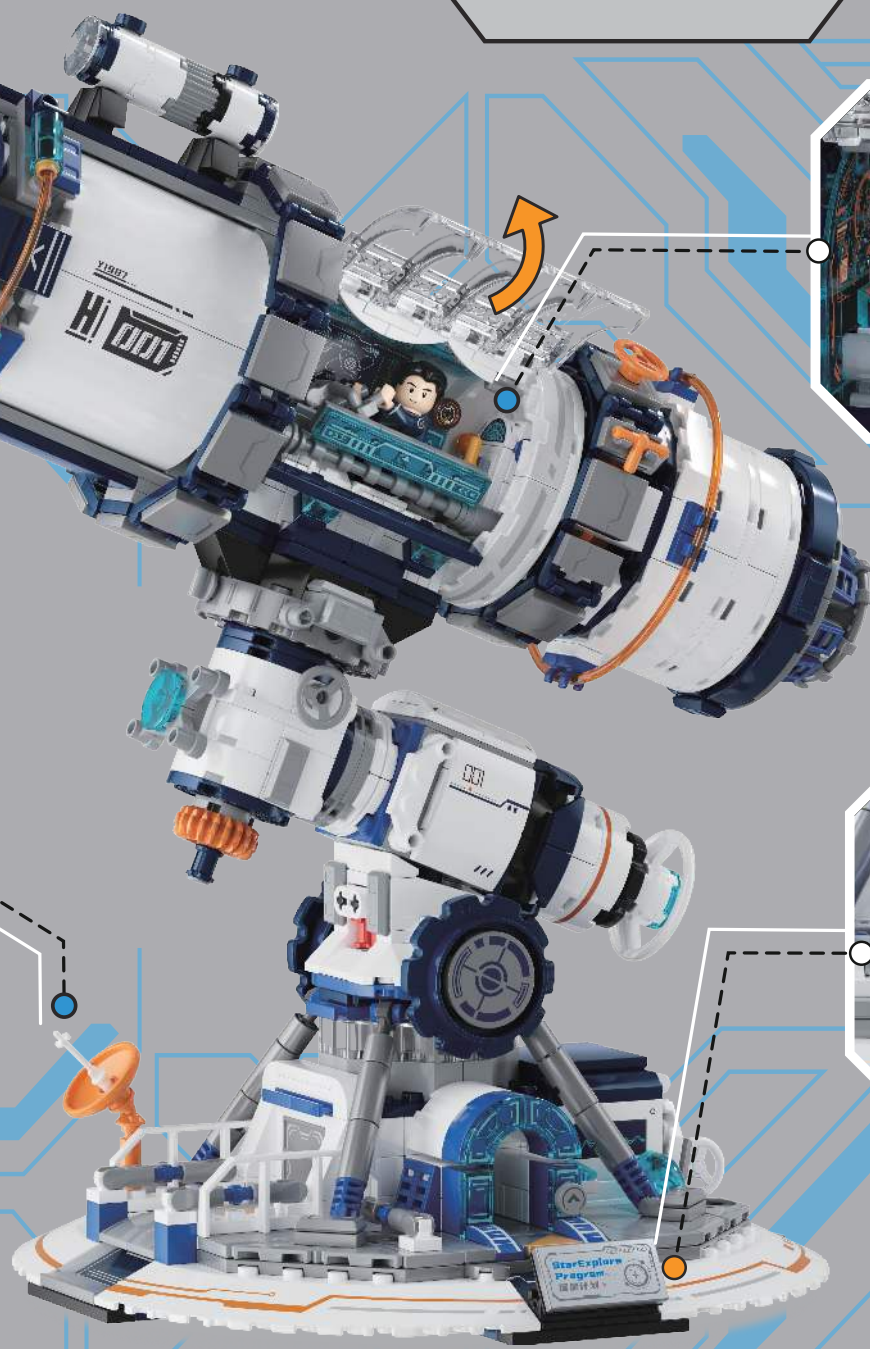

开工指南

Start guide

1

这样更好拼

按零件包的序号依次拼装

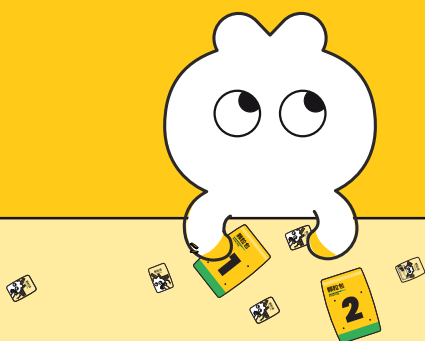

拼搭前可按颜色、形状分拣好颗粒

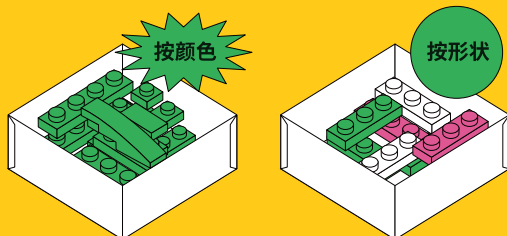

2

拼错怎么办?

拆件器的正确用法

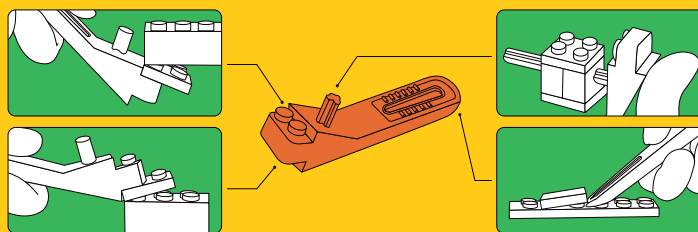

拆件器的错误用法

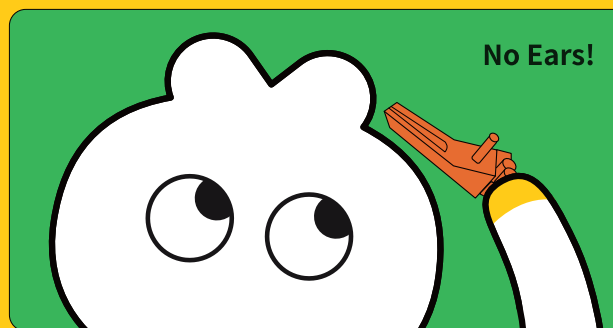

3

颗粒走丢怎么办?

关注未及wekki公众号
进入申请补件



- ① 扫描产品69条形码
或输入产品货号
- ② 按提示自助补件
- ③ 及时查询补件进度

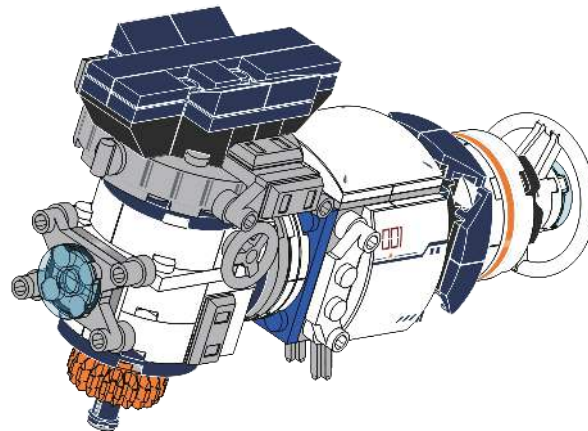
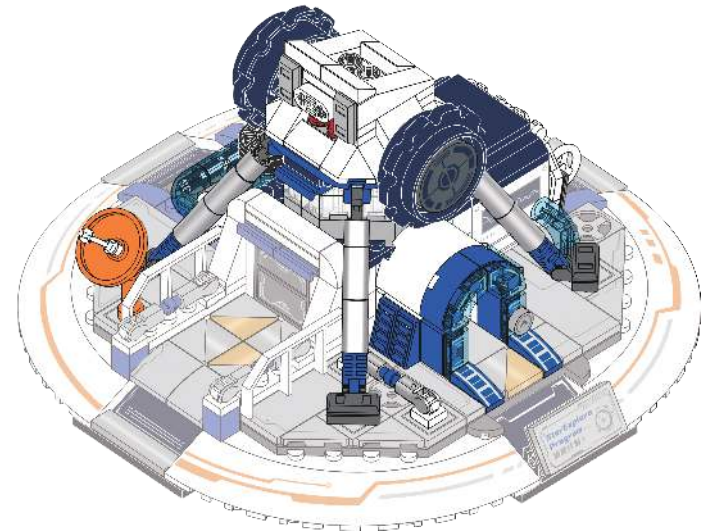
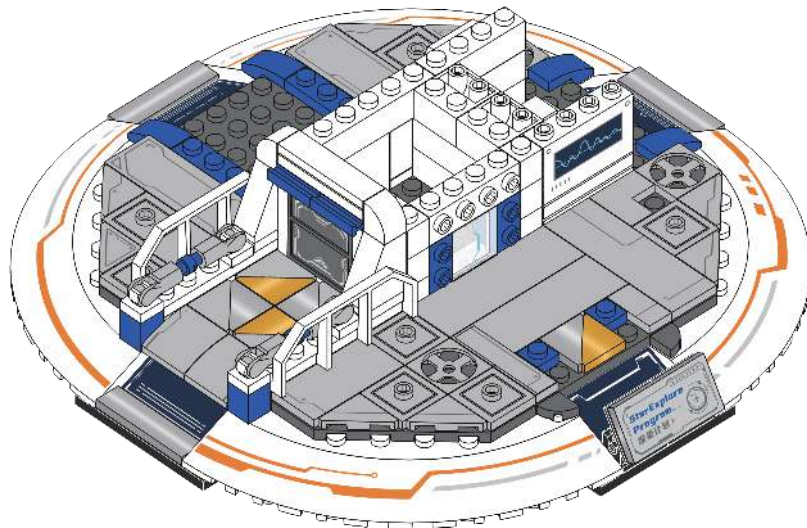



该配件与说明书放置同一物料袋中, 请勿随意丢弃

This and the manual should be kept in the same Wekki packet, so be careful not to throw them out.

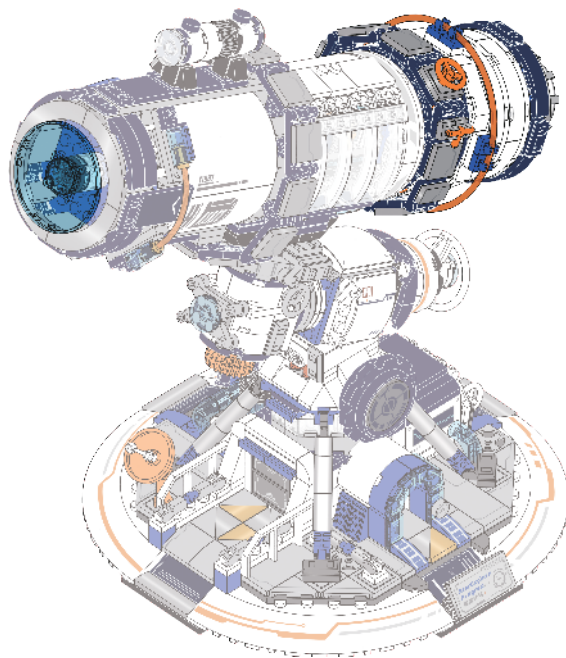
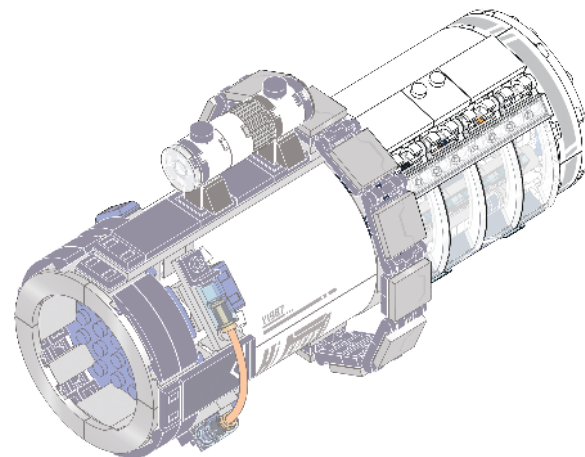
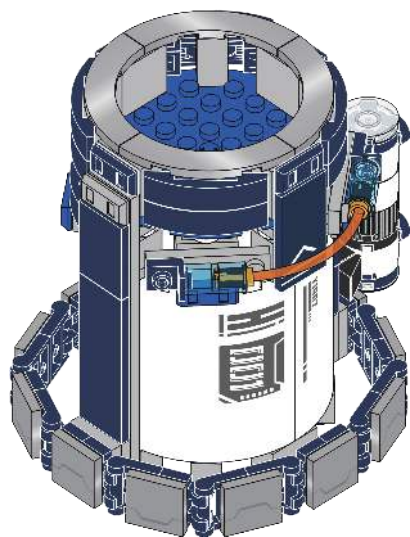

1

Particle bag No.1
1号颗粒袋

Completed drawing of
NO.1 granule bag

1号颗粒袋
完成图

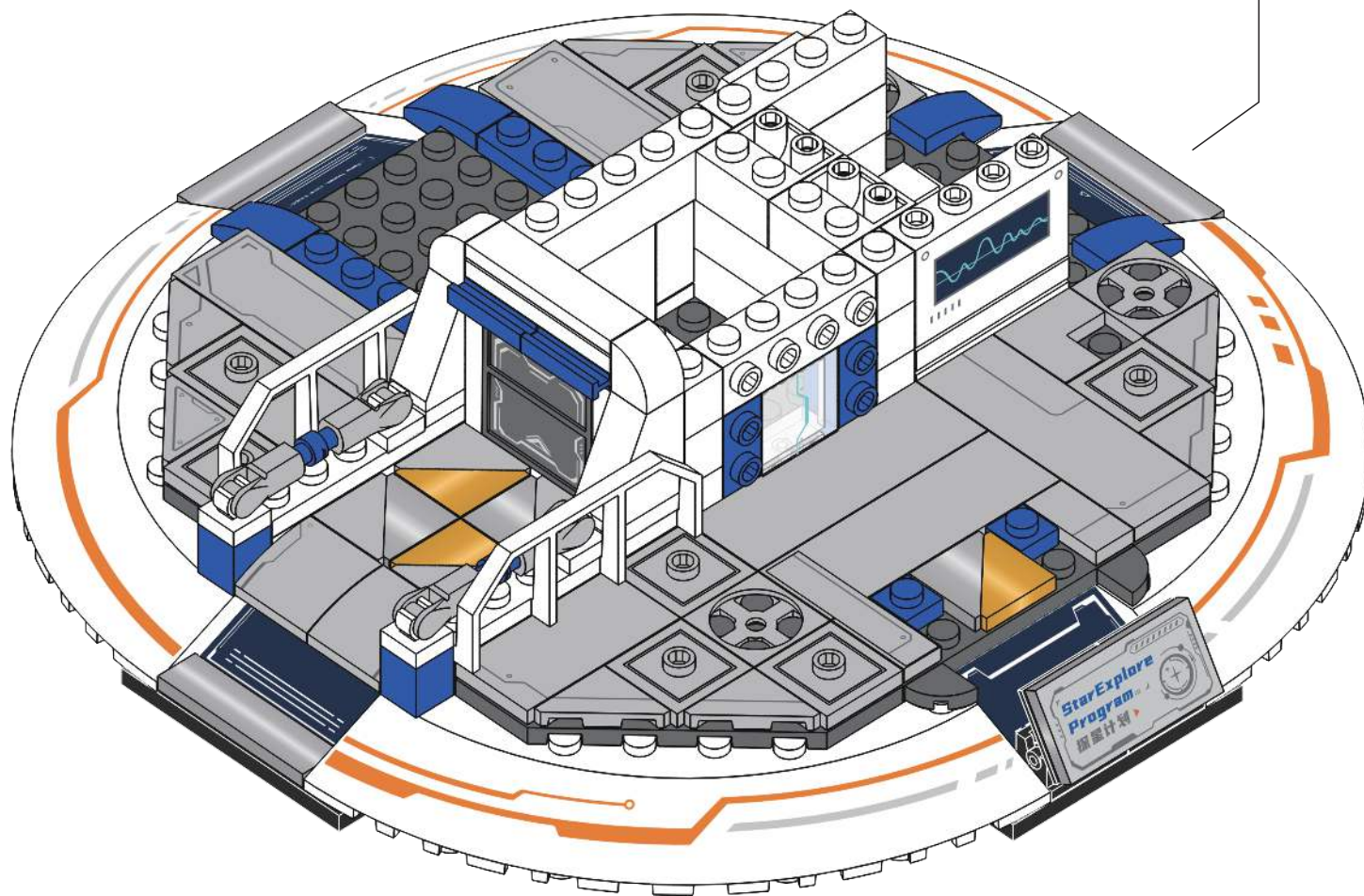

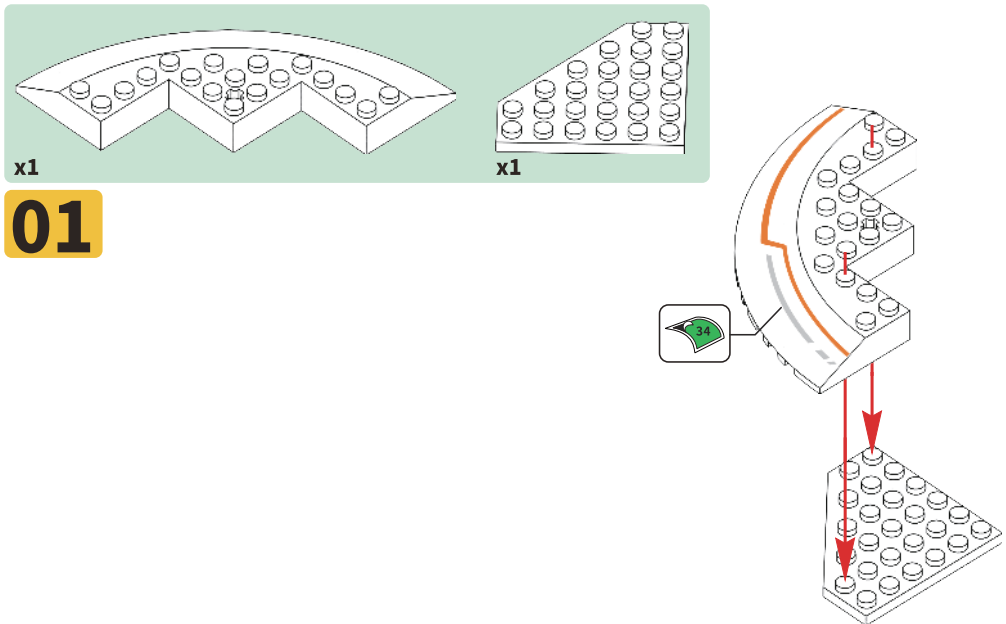

01

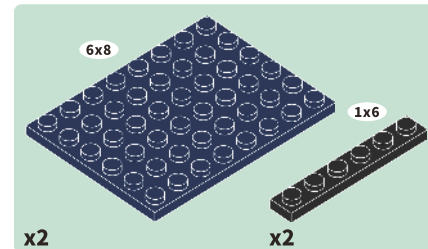

02

白色零件与蓝色零件的边缘对齐
Align the edge of the white and blue bricks

已组装的砖块以褪色显示
Built pieces shown in shades

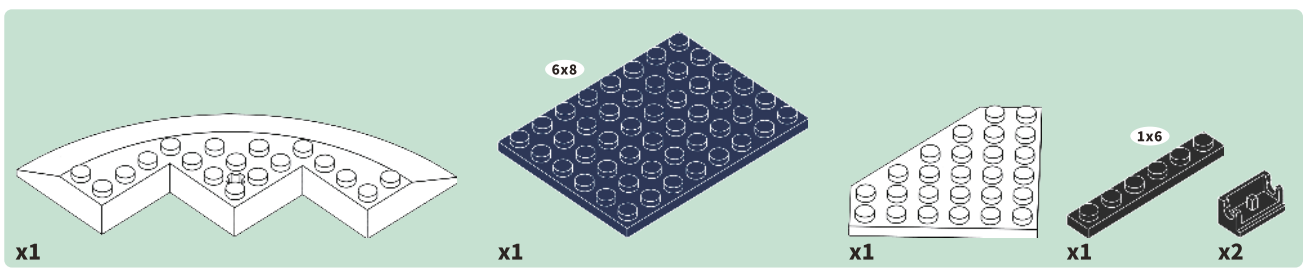
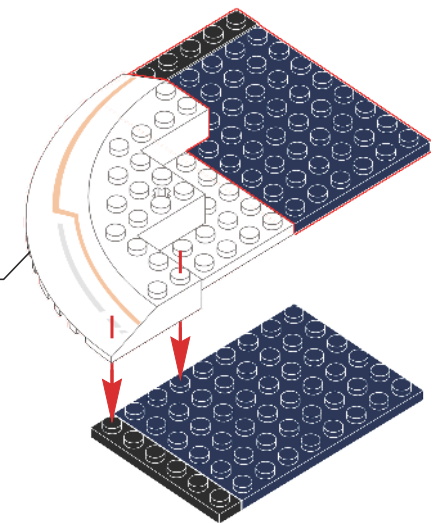

03

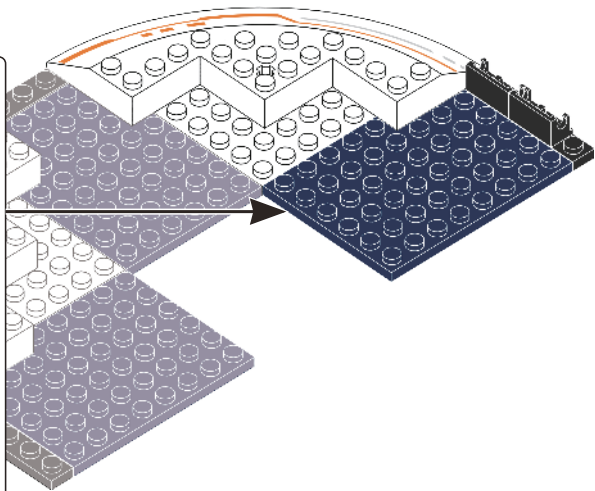
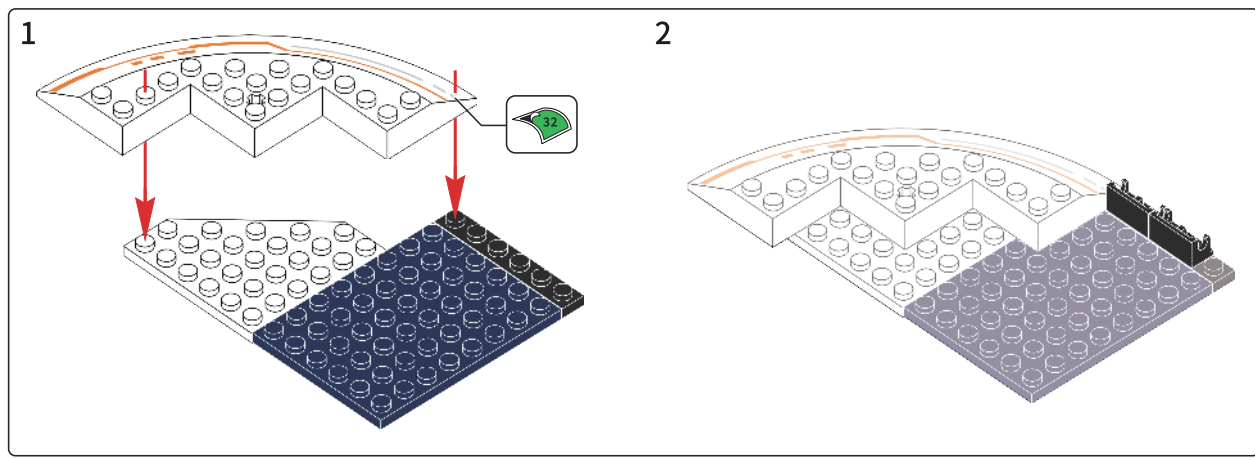

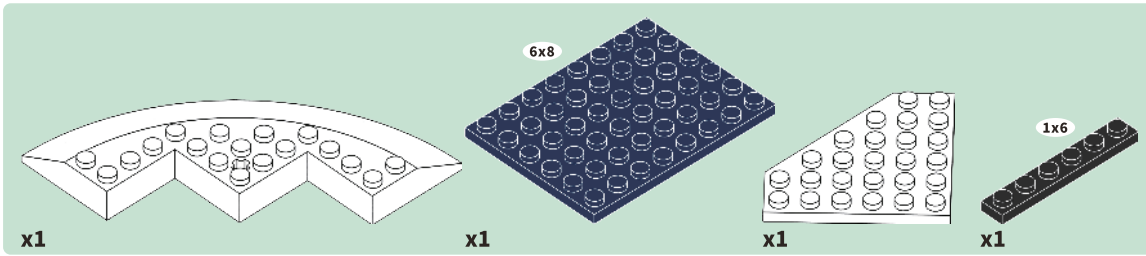

04

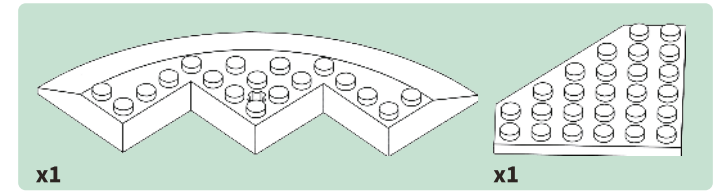
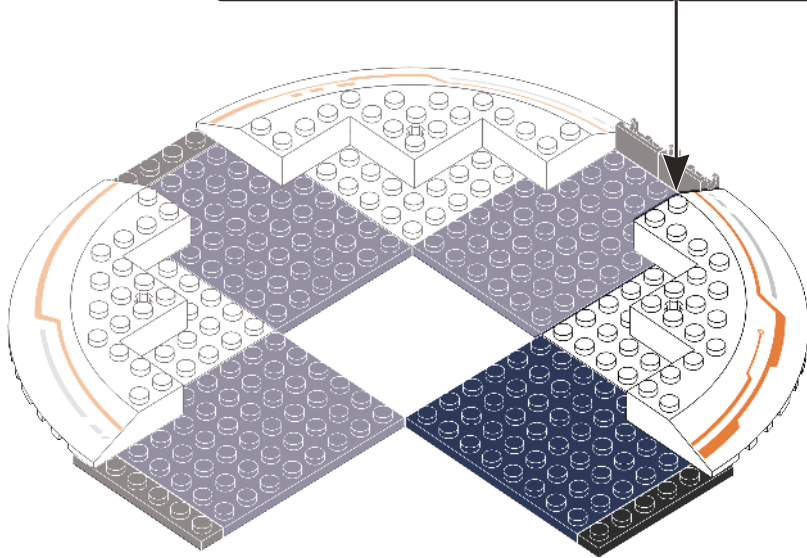
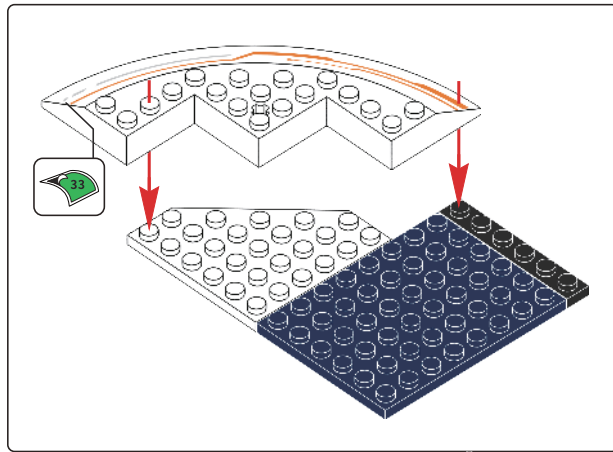

05

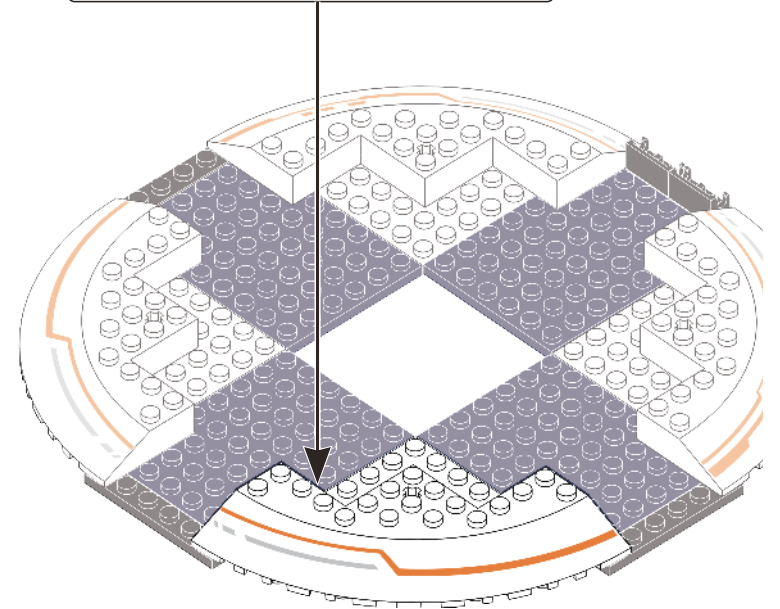
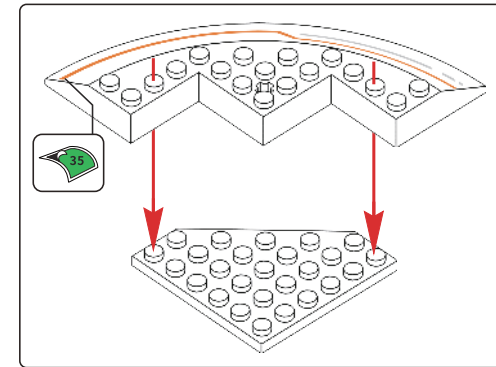

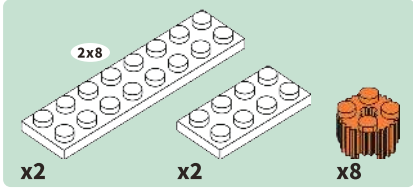

09

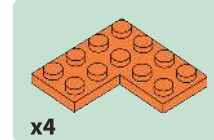
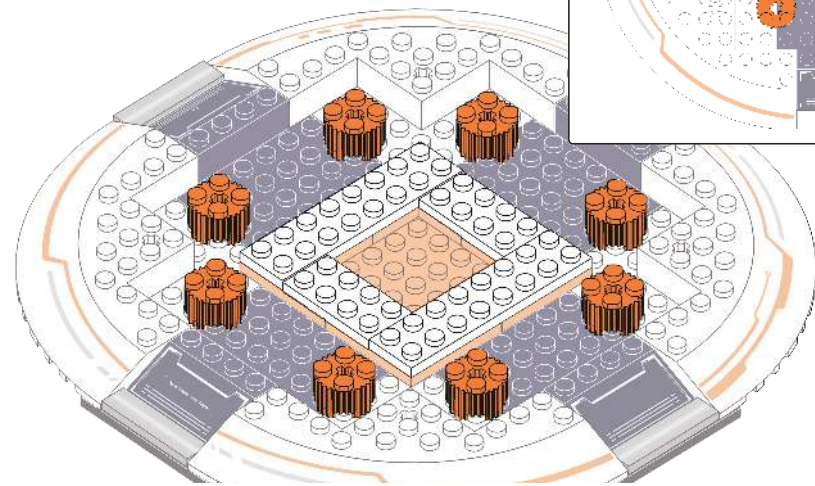
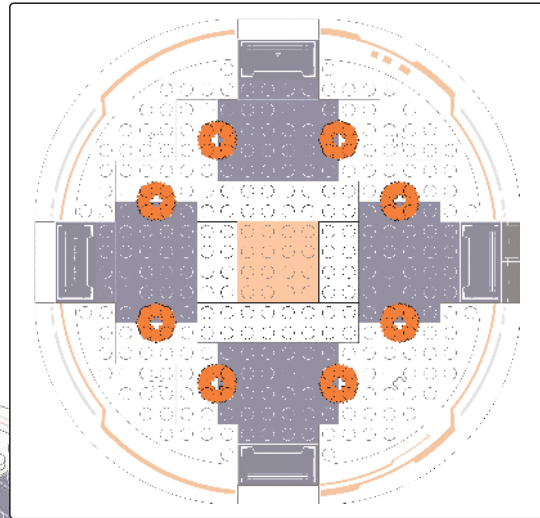

10

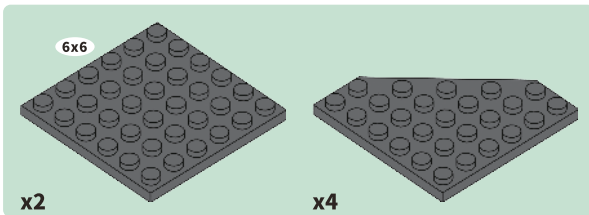
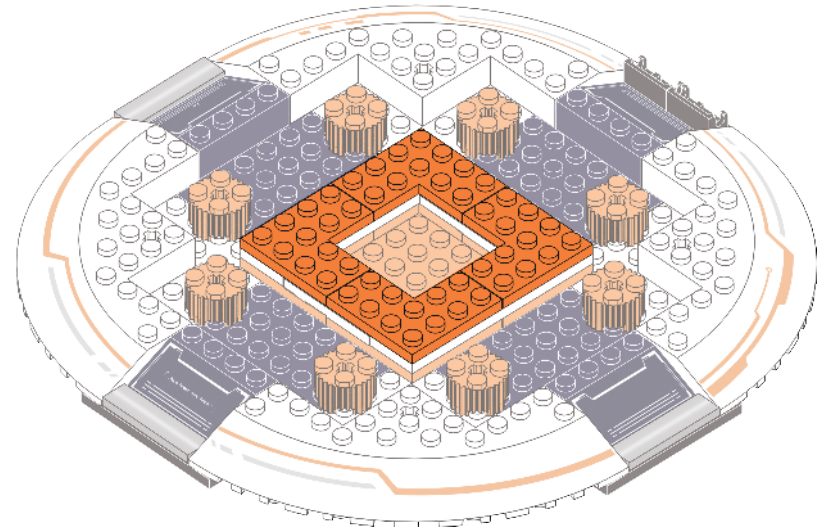

11

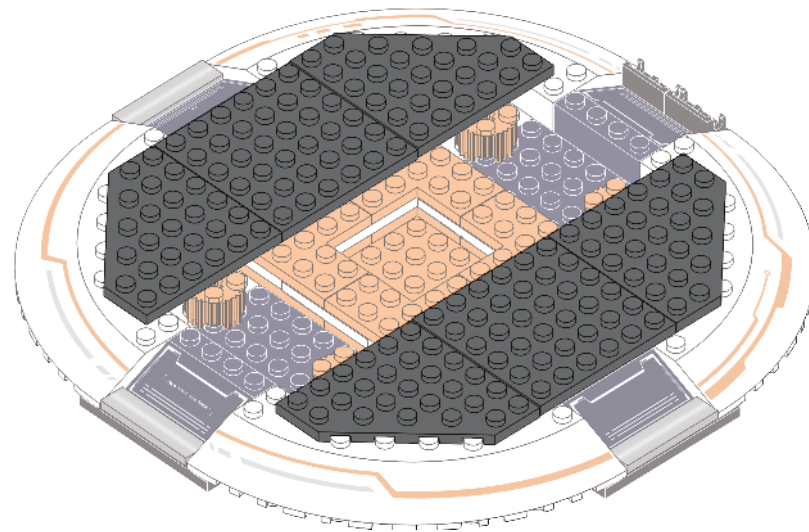

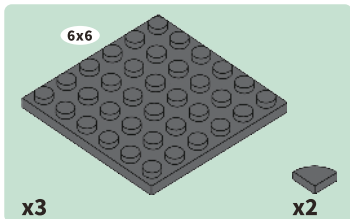

12

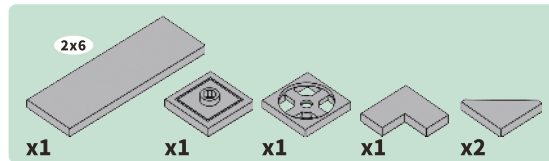
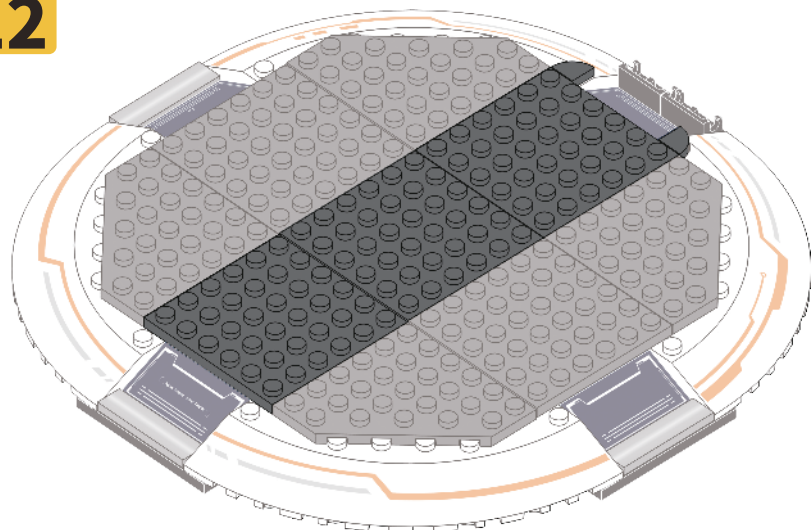

13

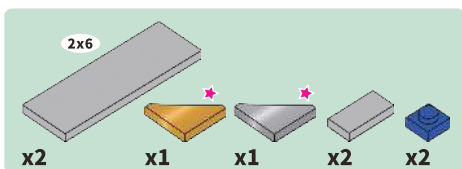
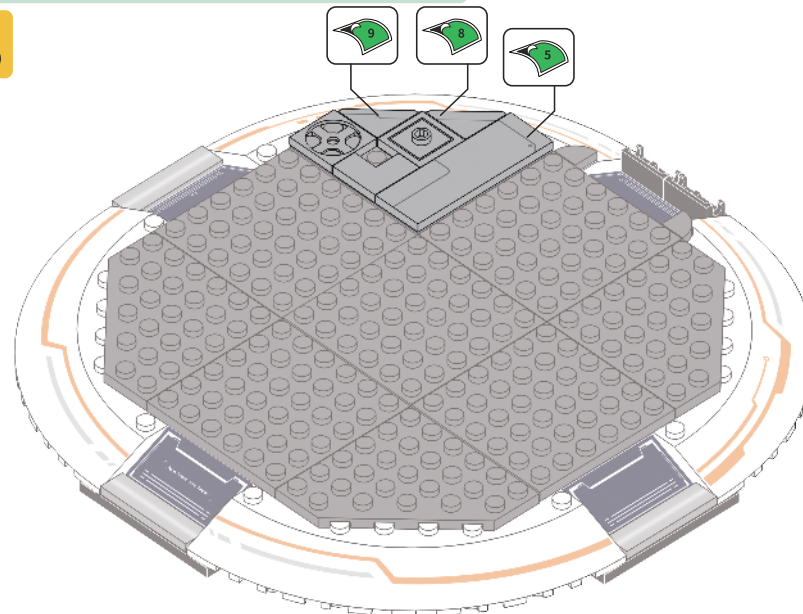

14

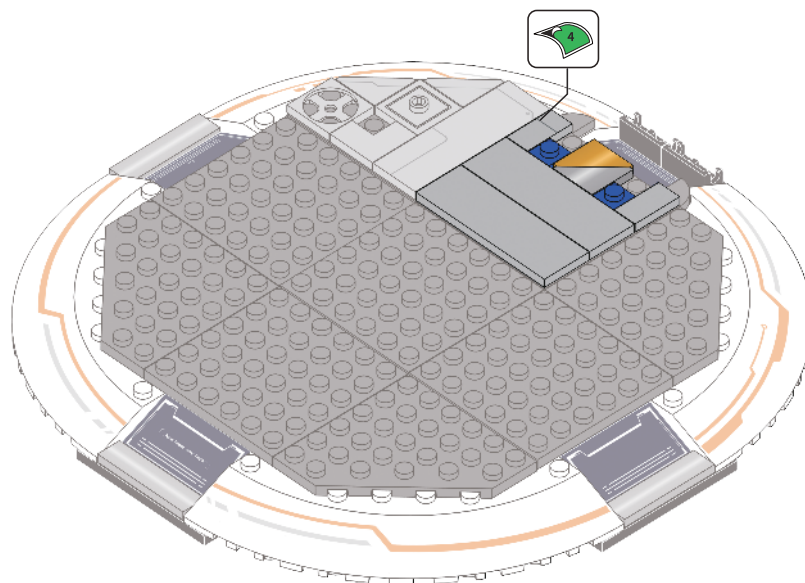

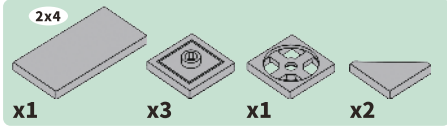

15

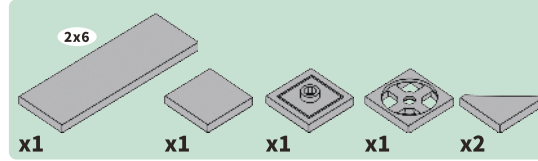
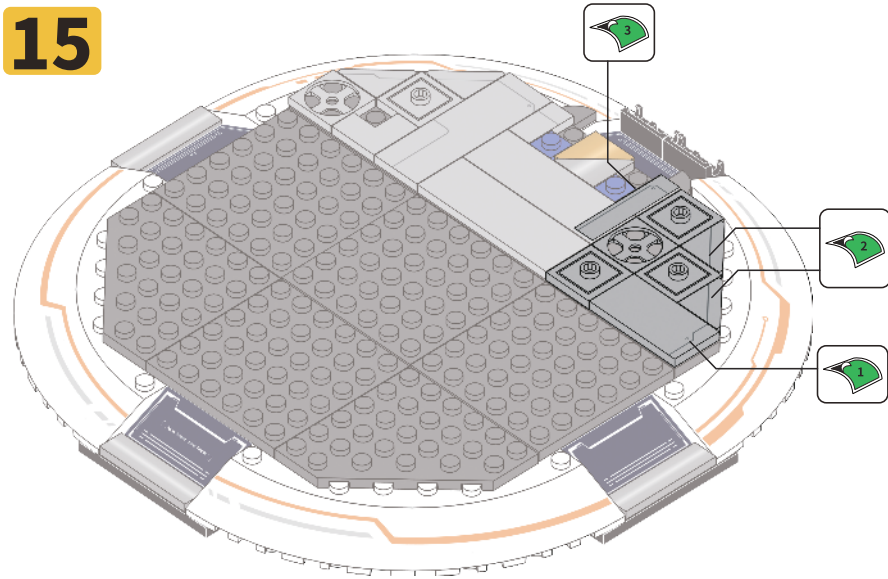

16

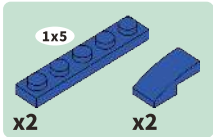
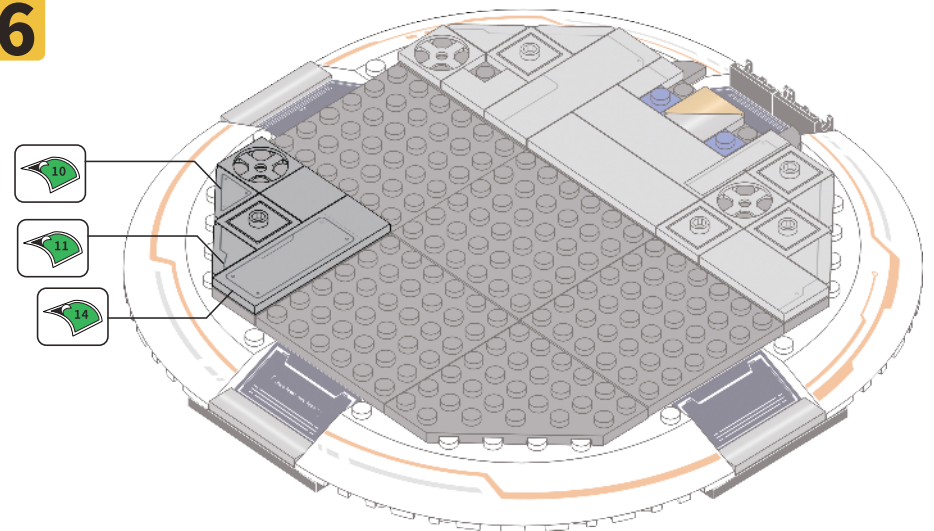

17

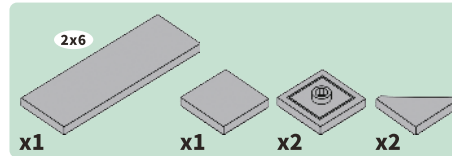
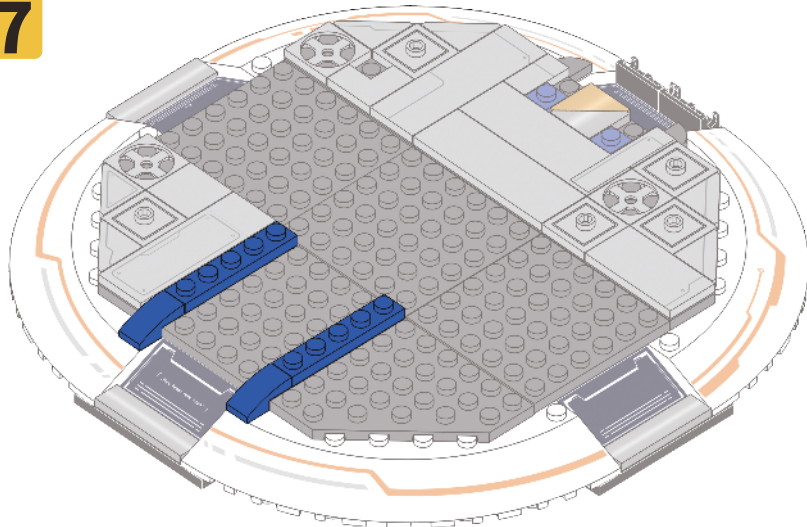

18

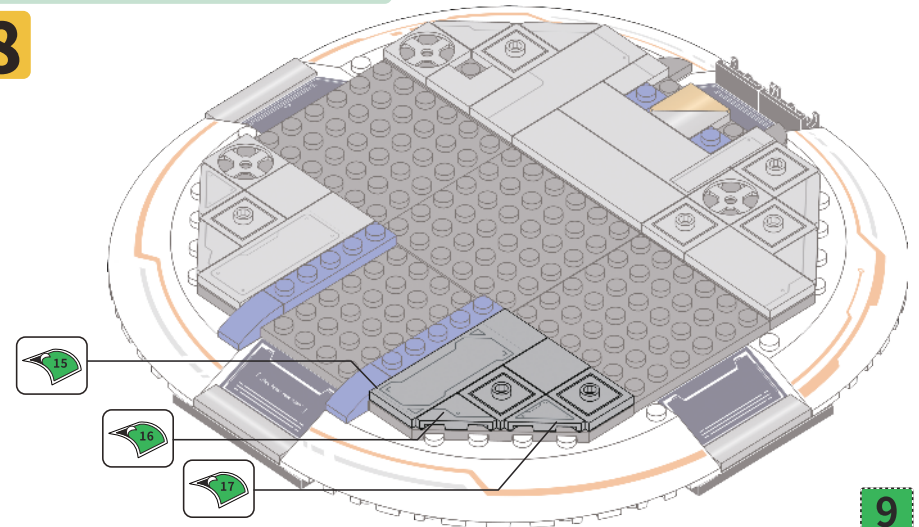

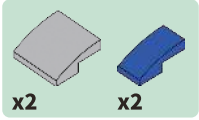

19

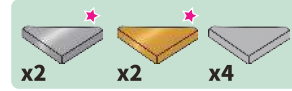
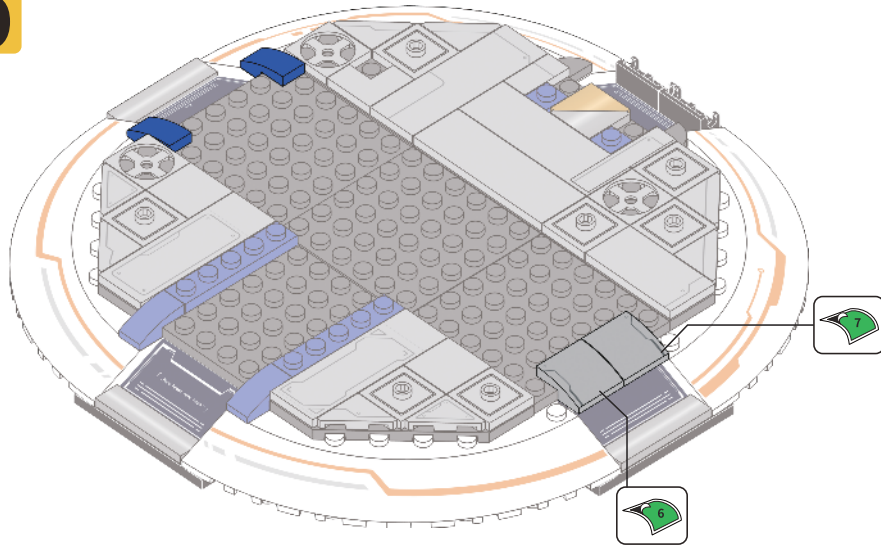

20

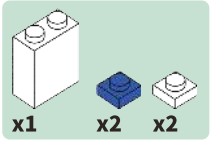
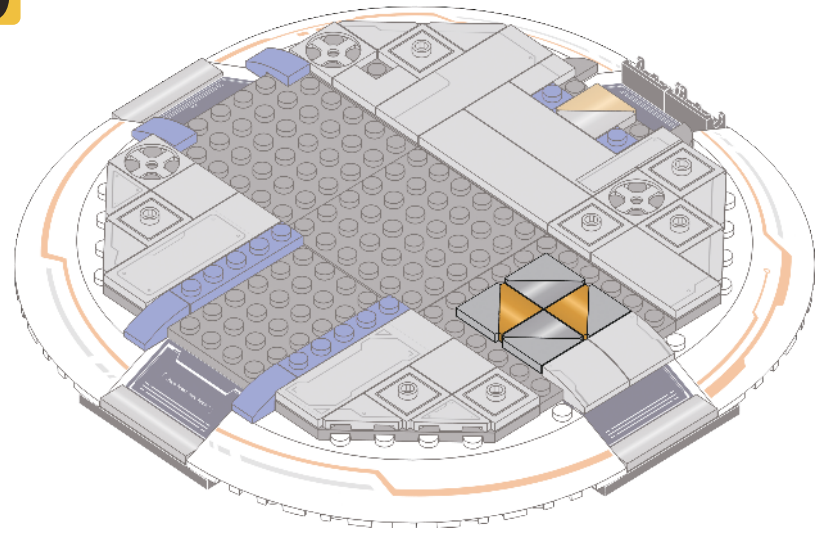

21

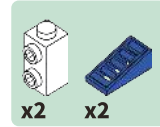
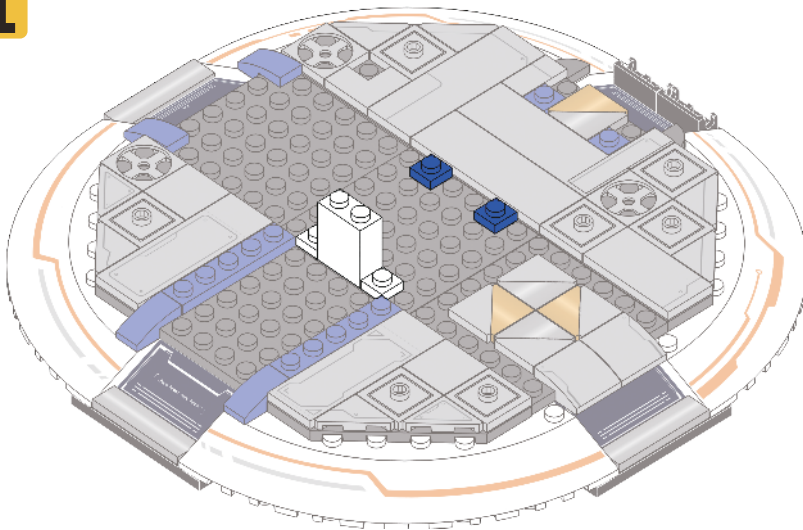

22

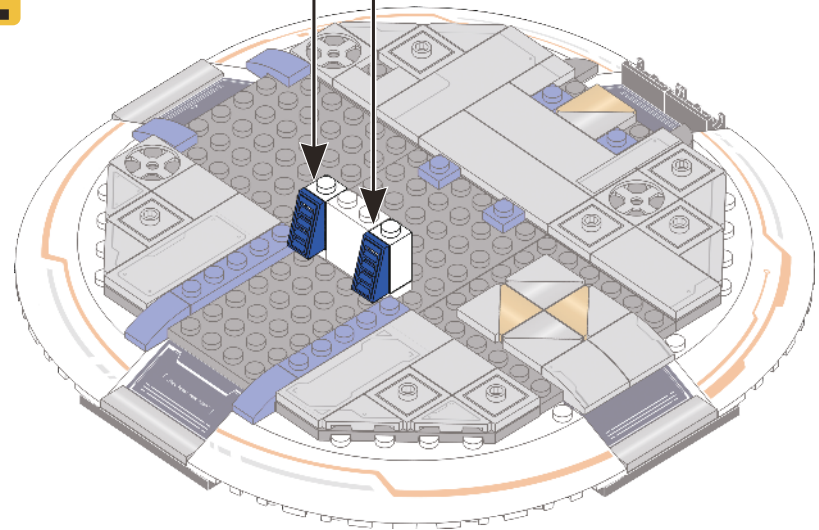
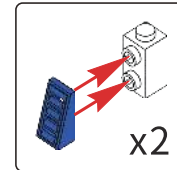

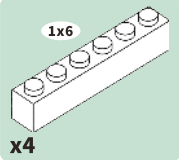

23

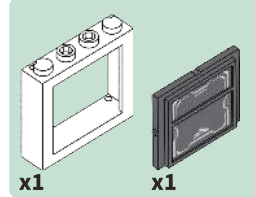
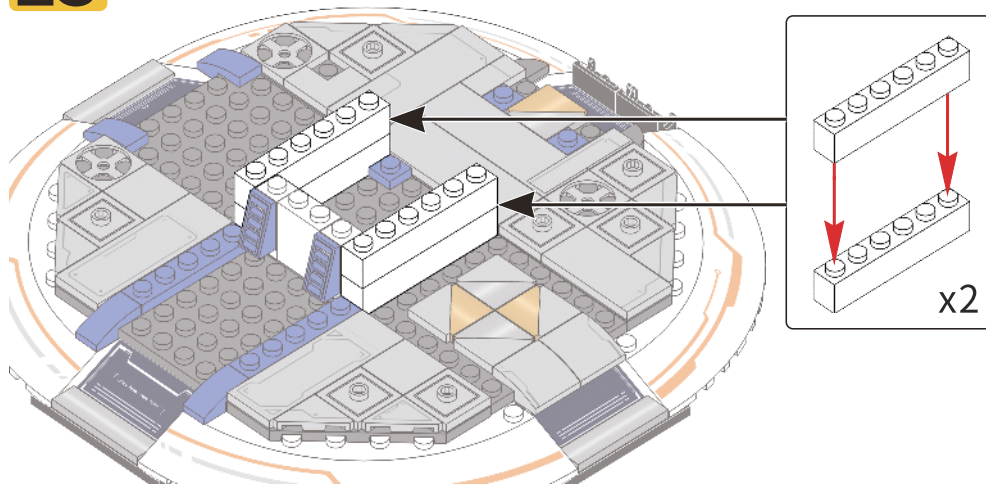

24

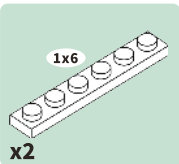
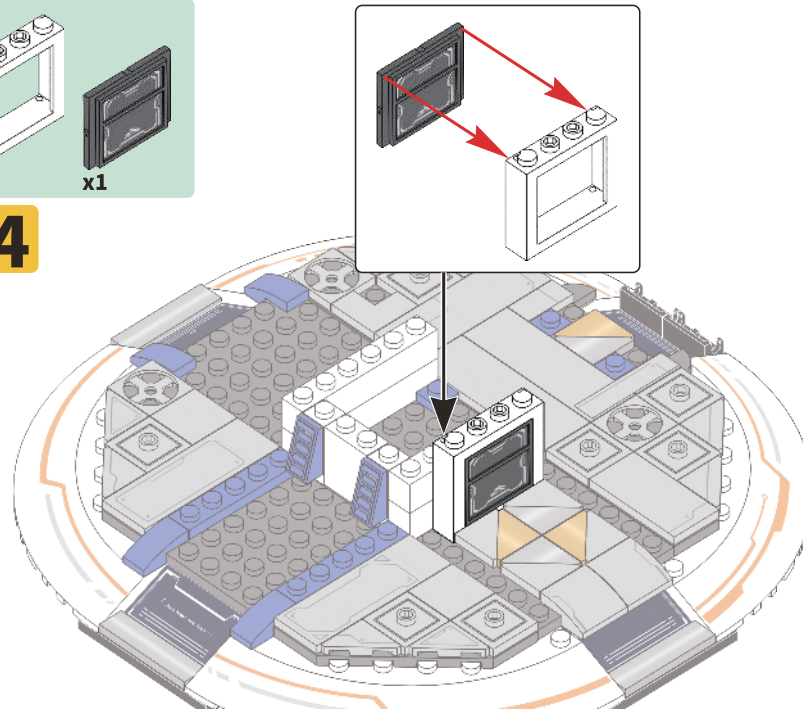

25

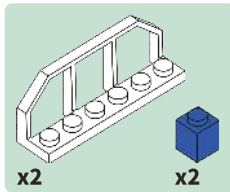
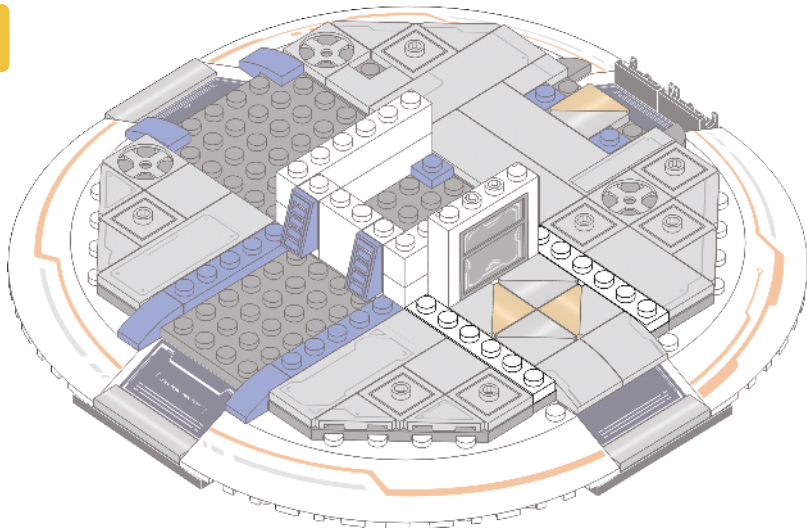

26

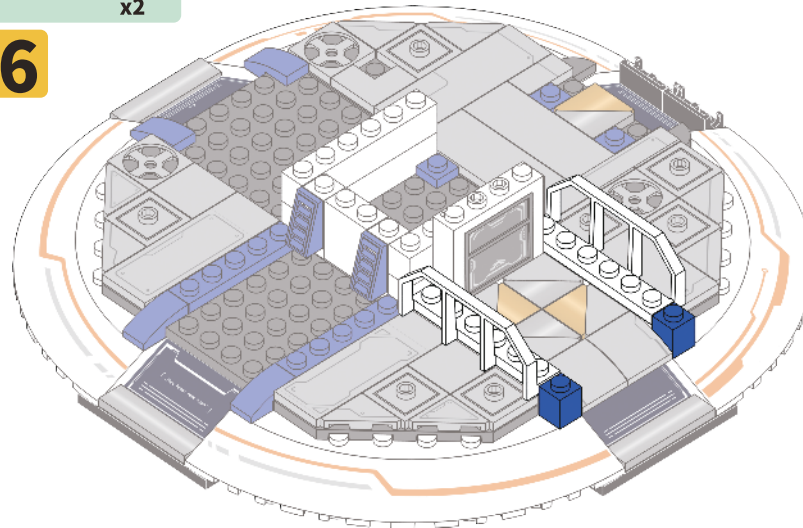

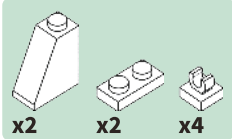

27

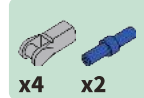
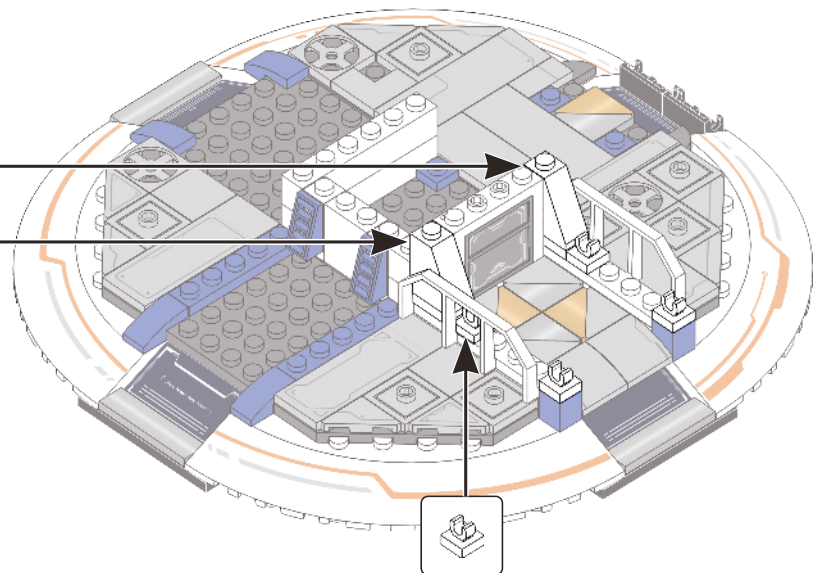
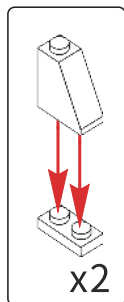

28

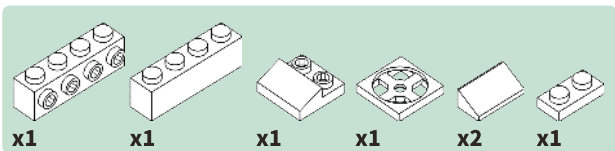
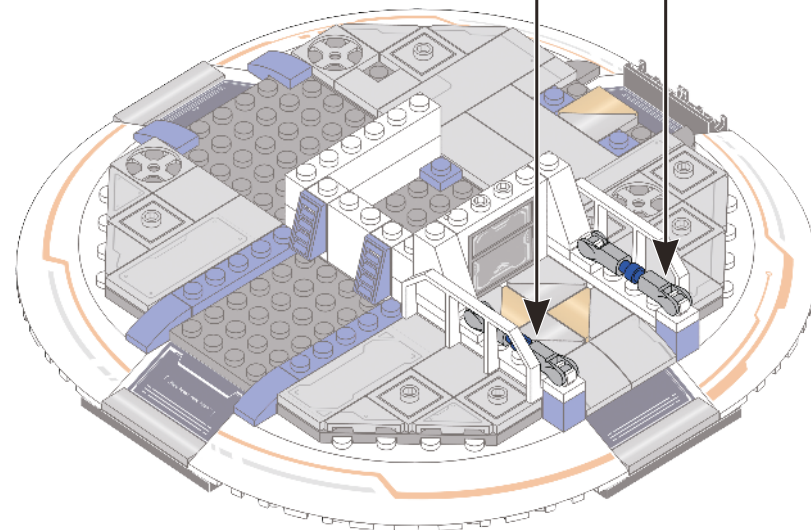
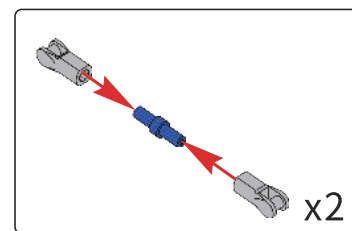

29



把积木翻转过来
Turn the blocks over

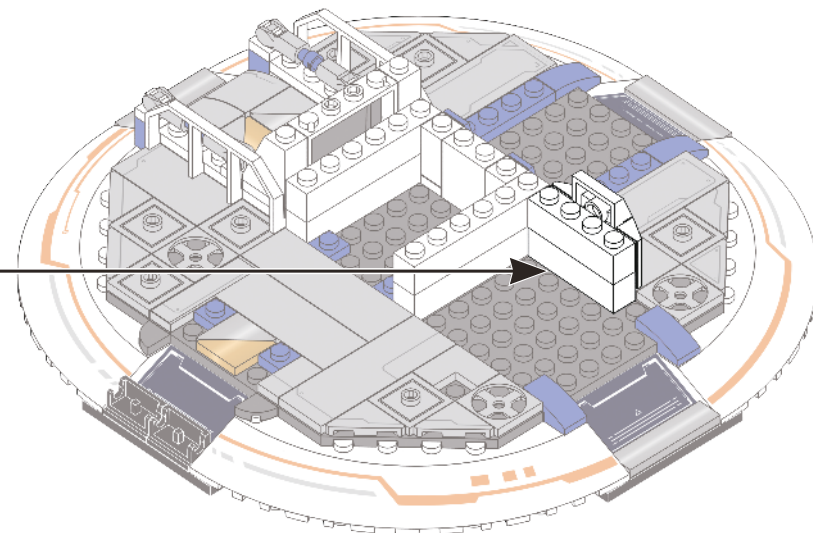
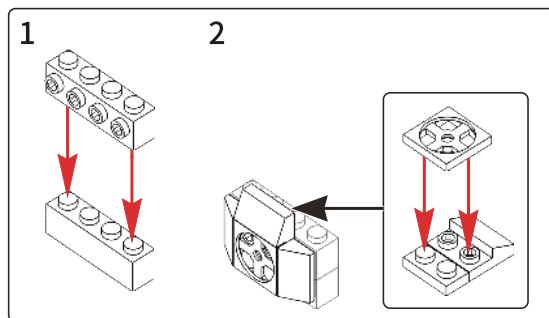

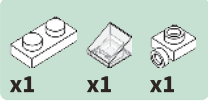

30

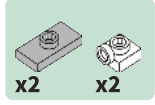
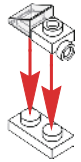

31

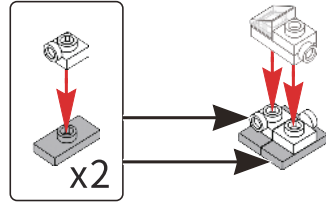

32

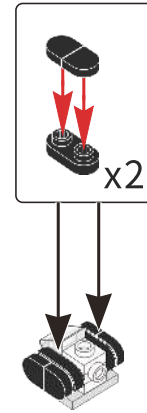

33



34

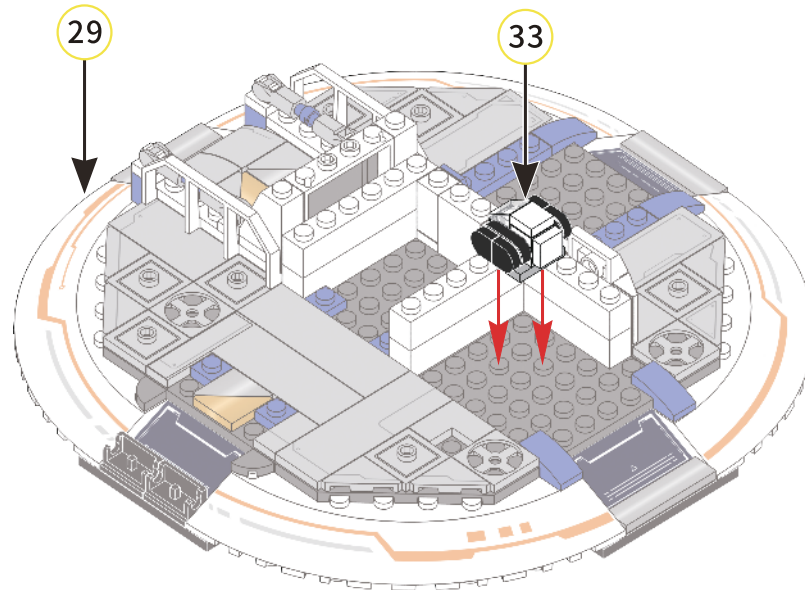

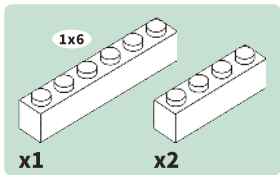

35

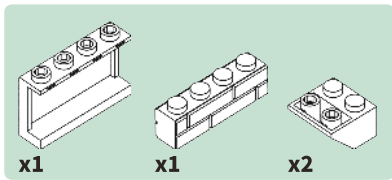
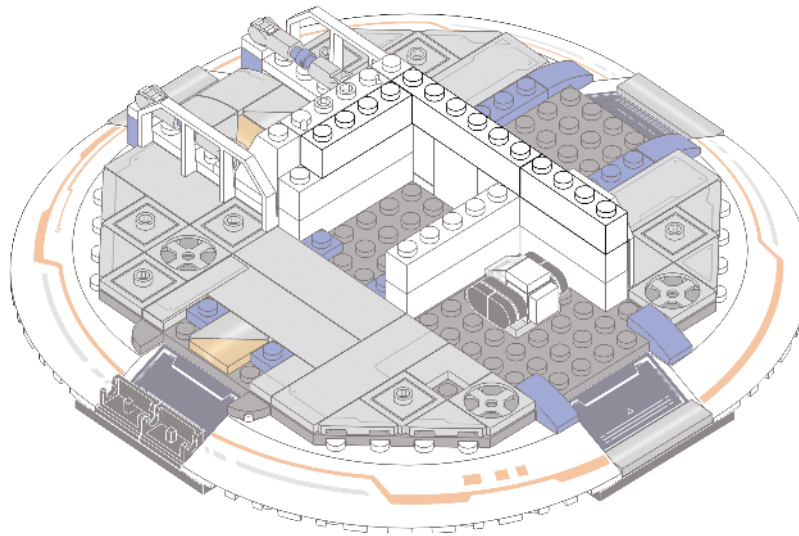

36

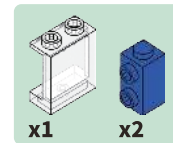
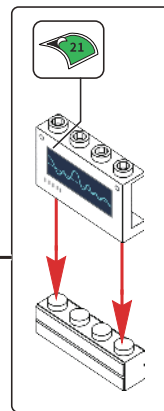
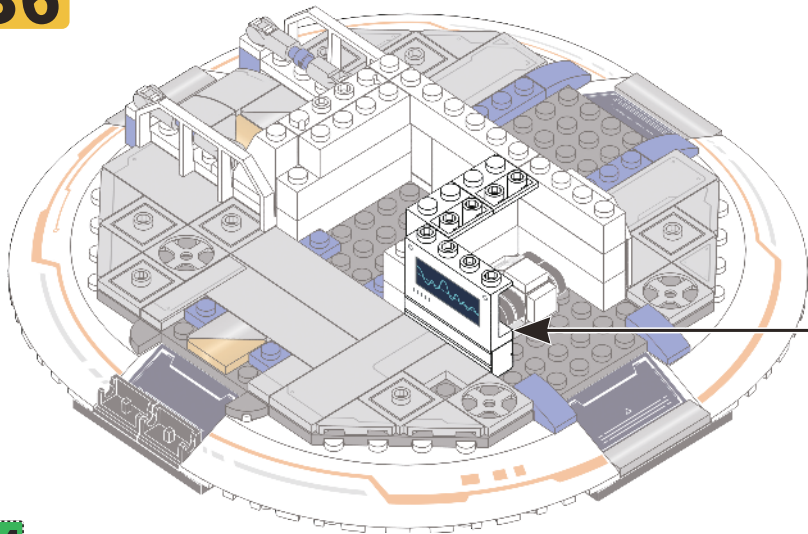

37

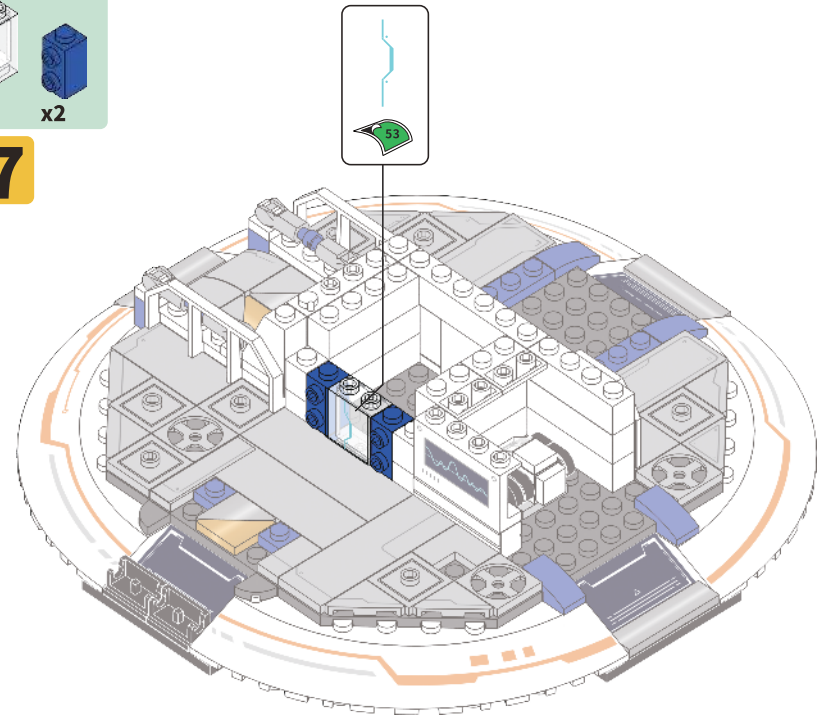

2

Particle bag No.2
2号颗粒袋

Completed drawing of
NO.2 granule bag
2号颗粒袋
完成图

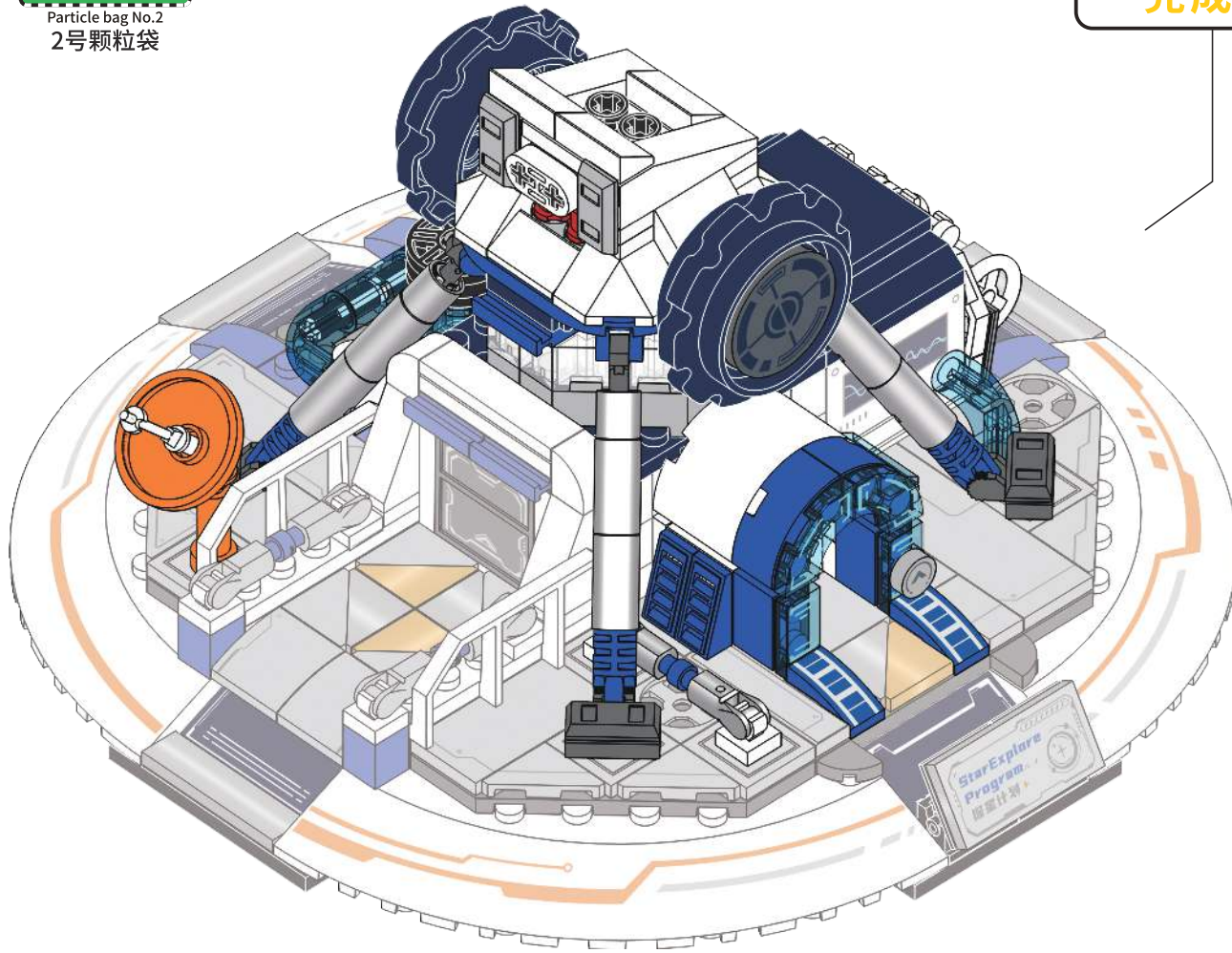

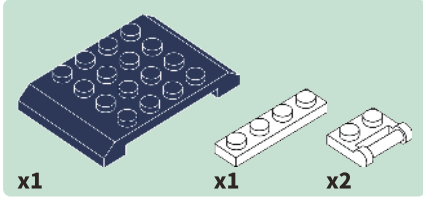

41

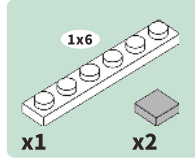
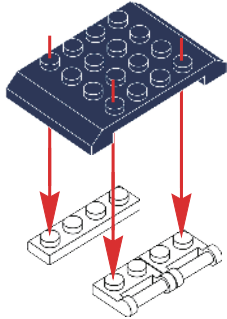

42

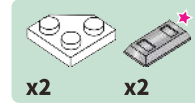
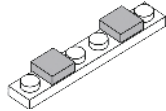

43

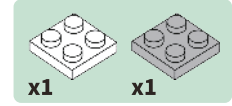
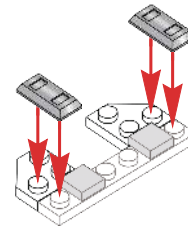

44

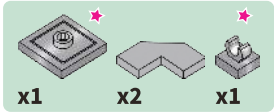
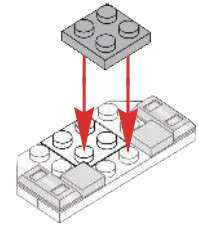

45

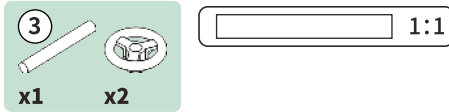
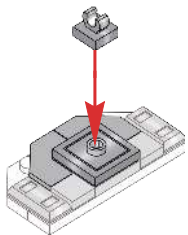

46

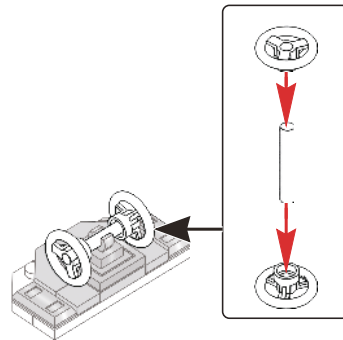

47

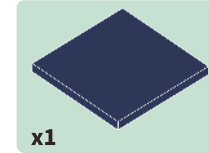
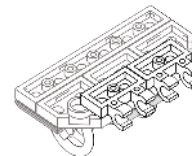

48

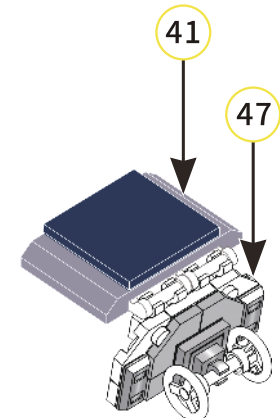

49

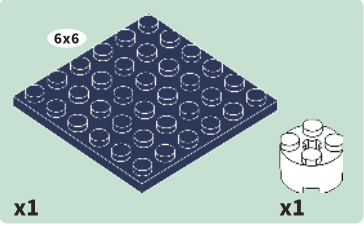
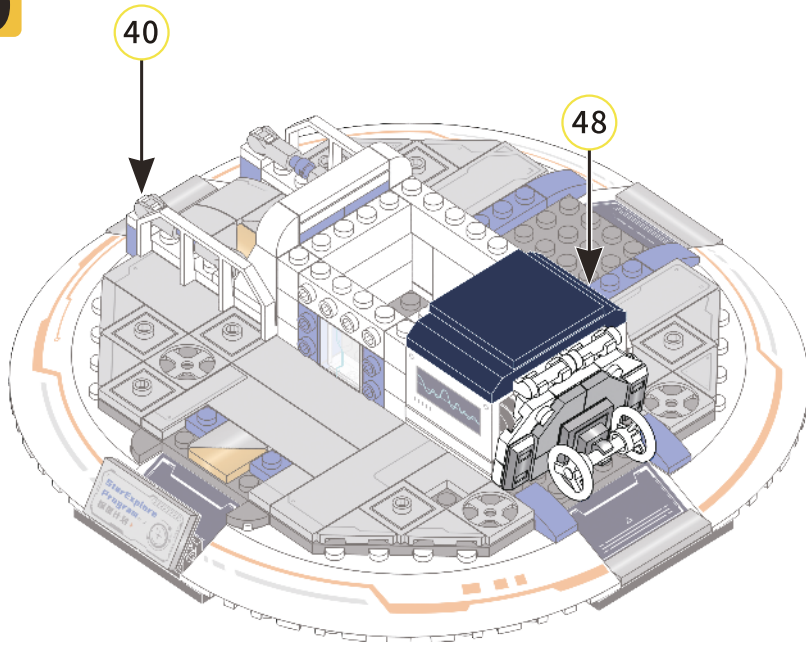

50

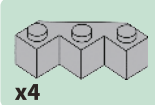
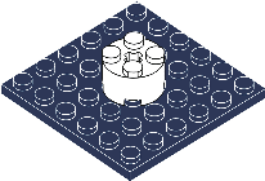

51

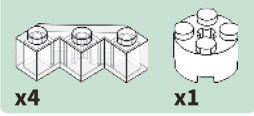
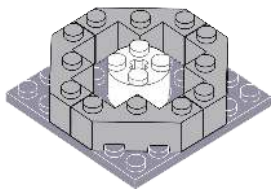

52

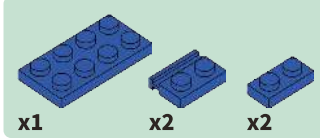
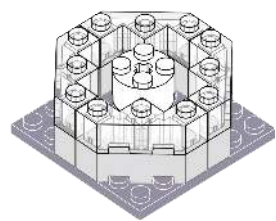

53

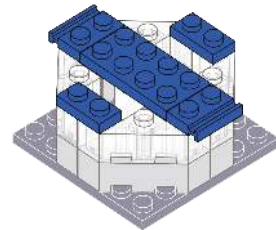

54

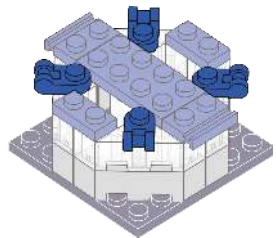

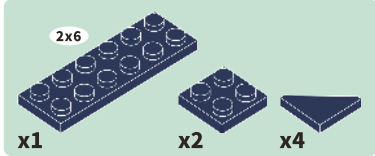

55

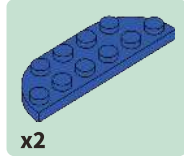
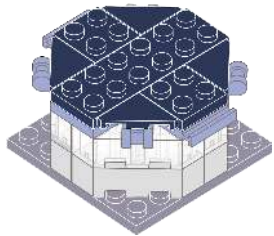

56

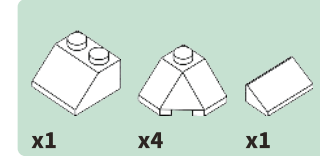
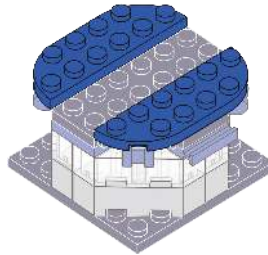

57

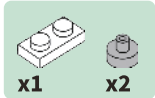
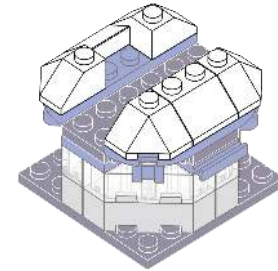

58

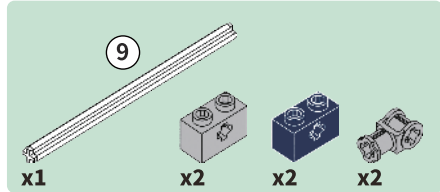
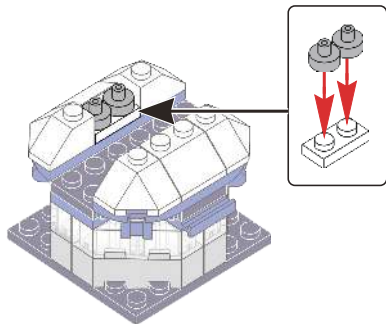

59

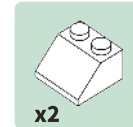
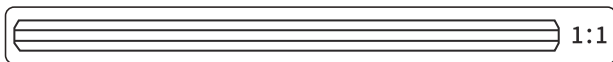
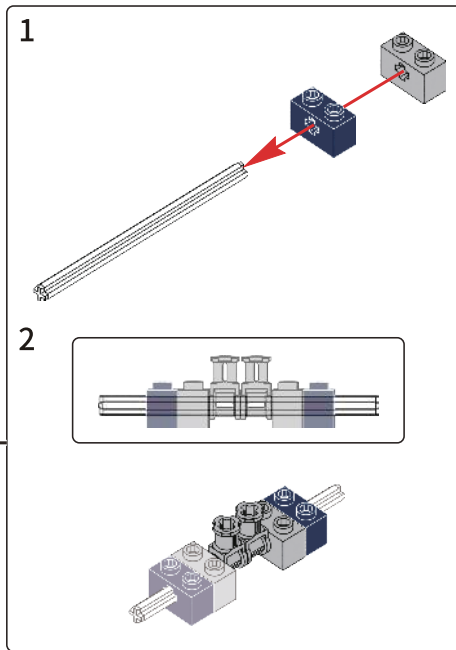
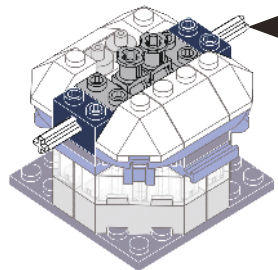

60

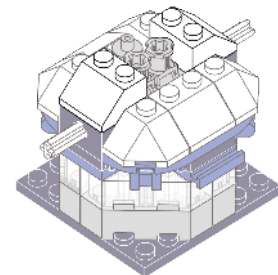

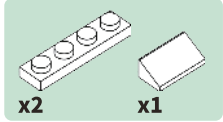

61

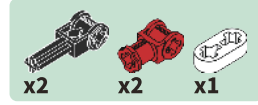
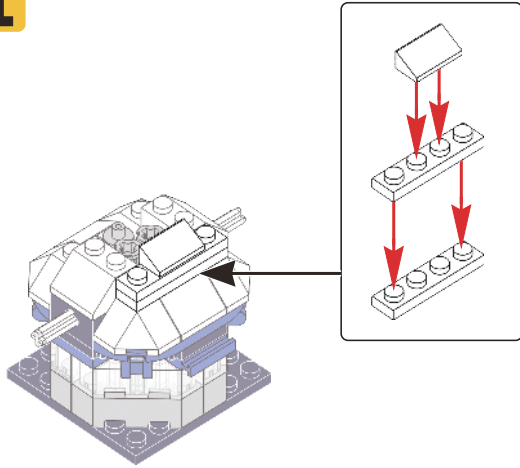

62

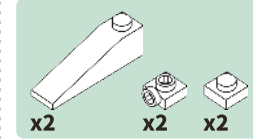
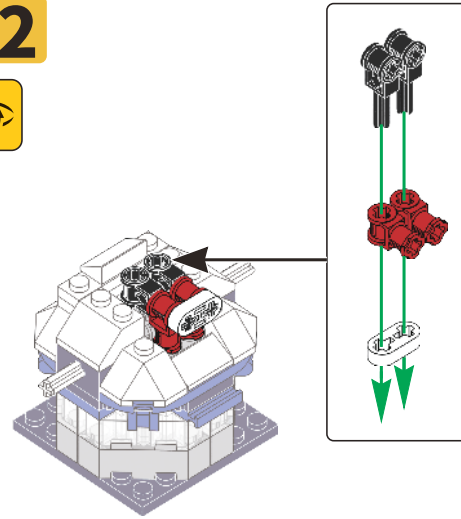

63

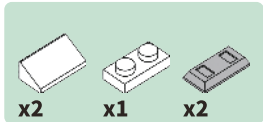
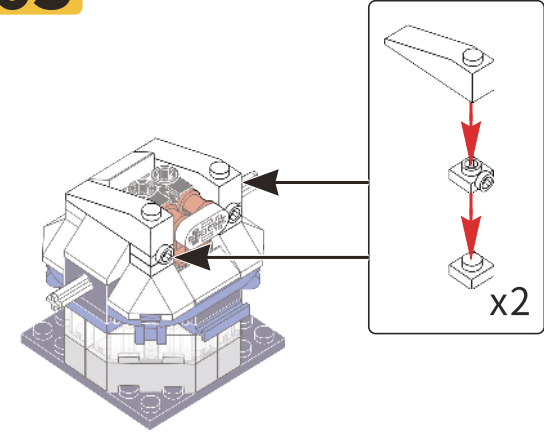

64

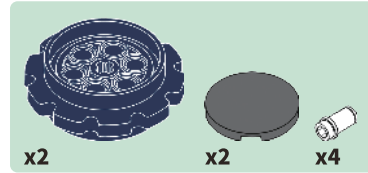
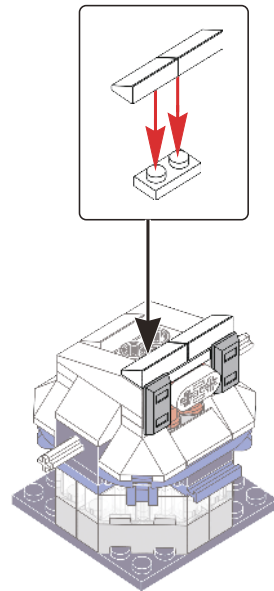

65

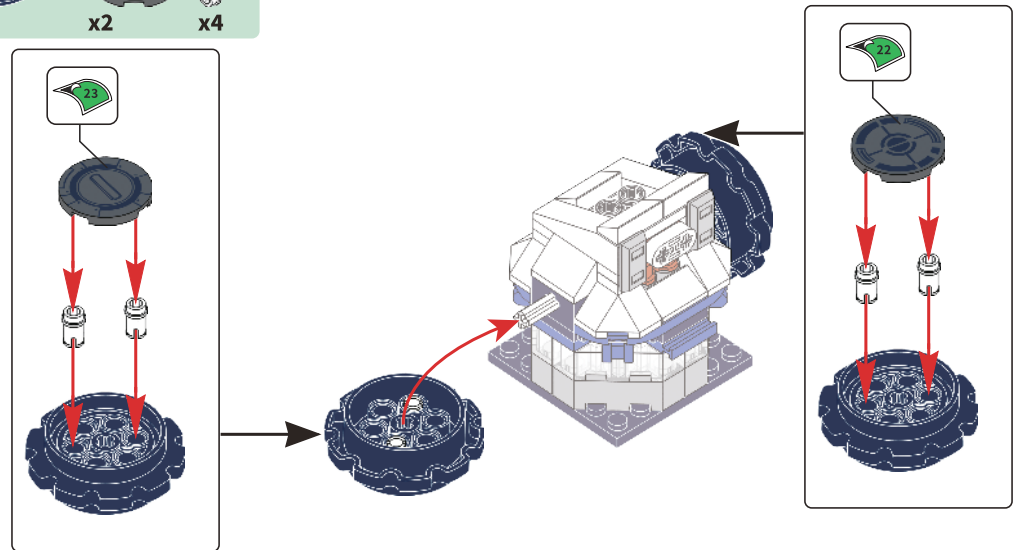

66

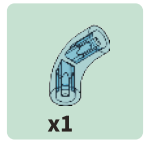
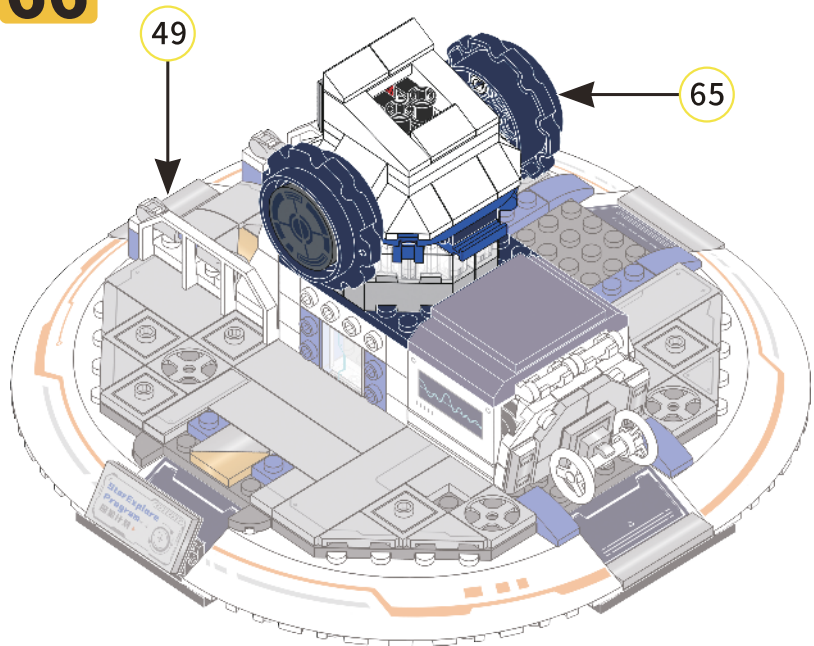

67

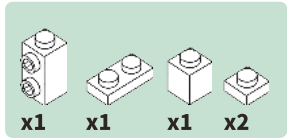
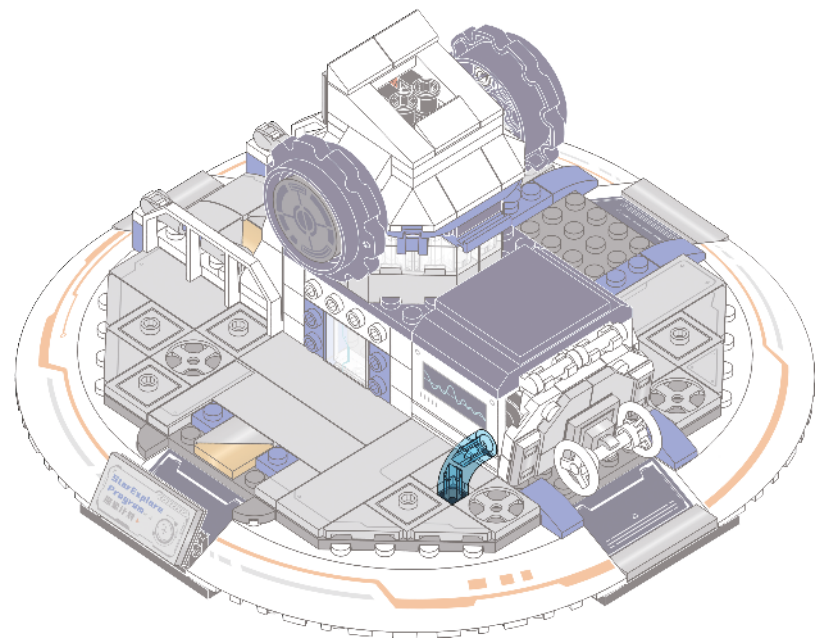

68

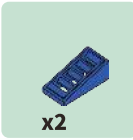
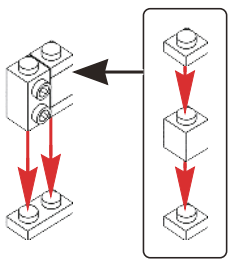

69

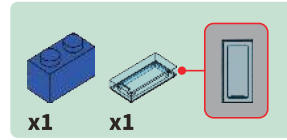
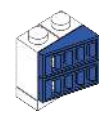

70

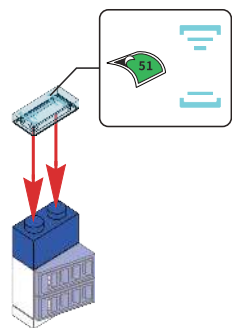

71

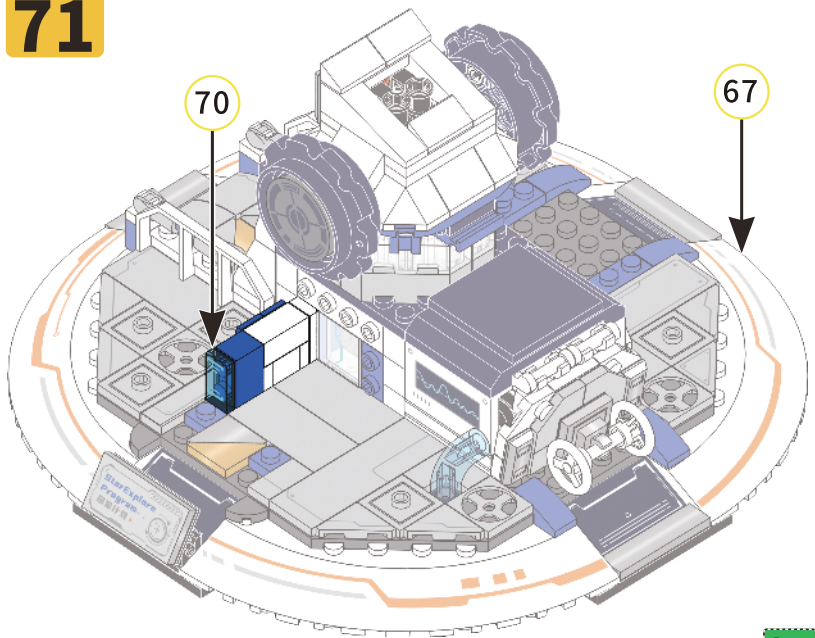

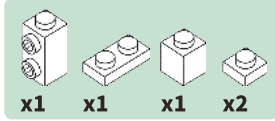

72

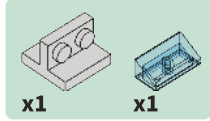
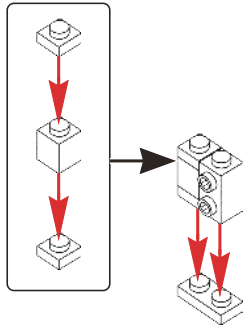

73

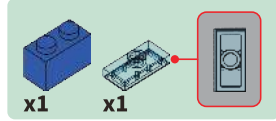
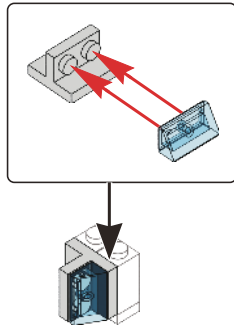

74

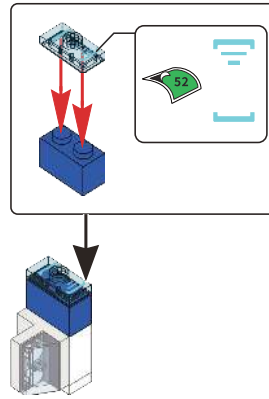

75

71

74

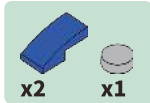
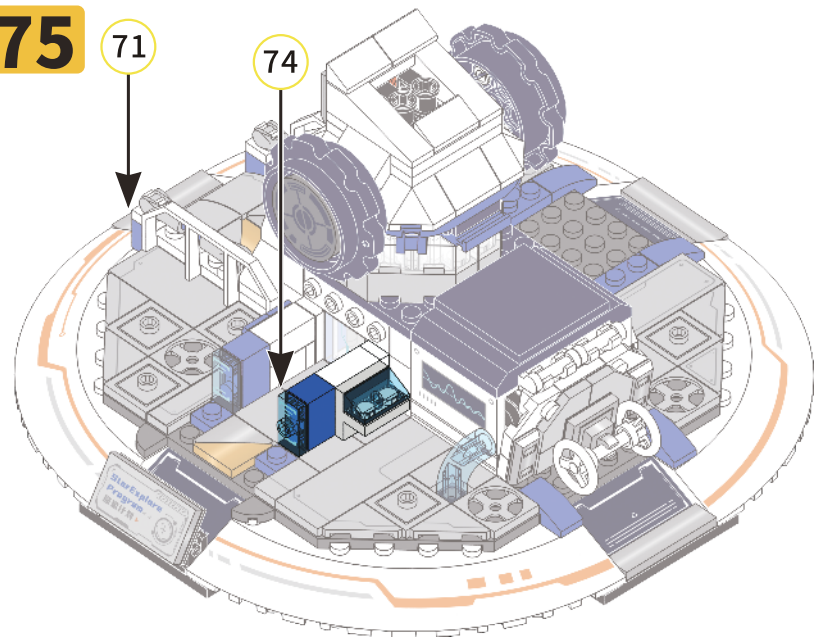

76

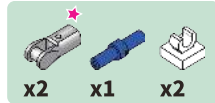
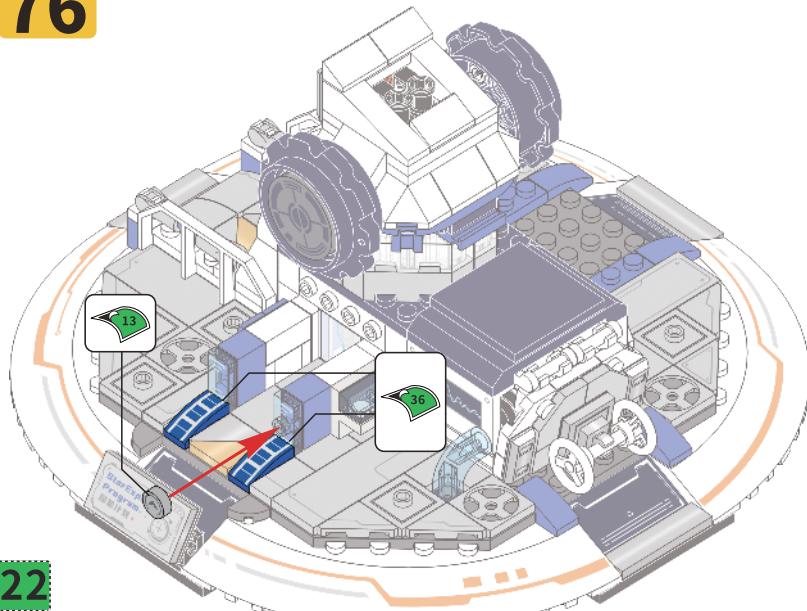

77

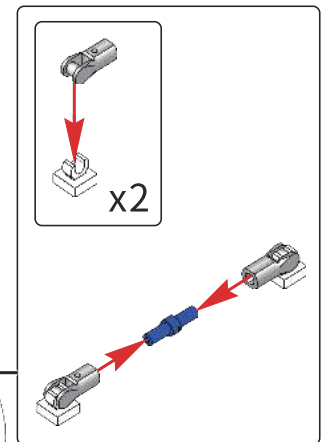
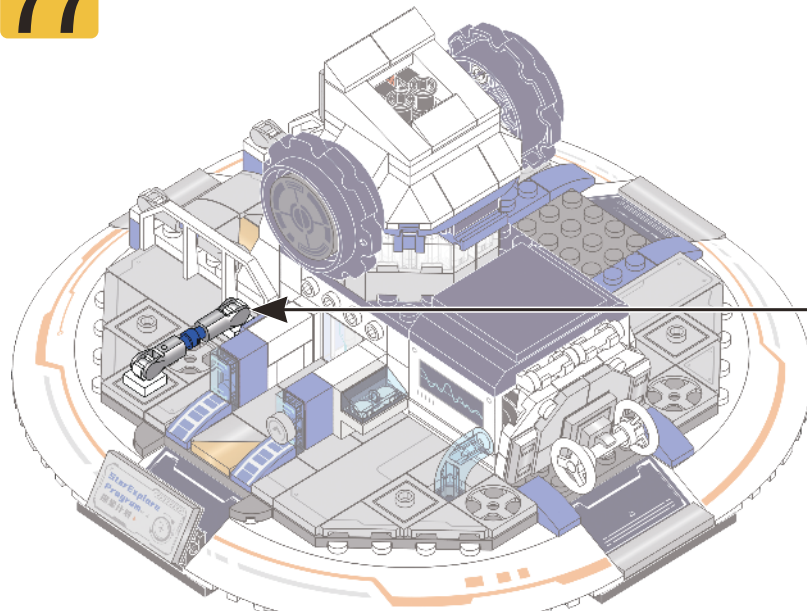

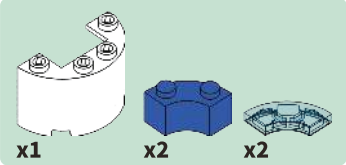

78

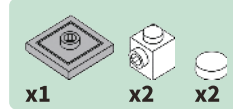
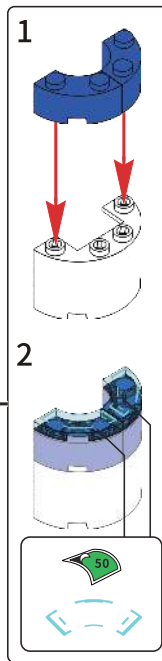
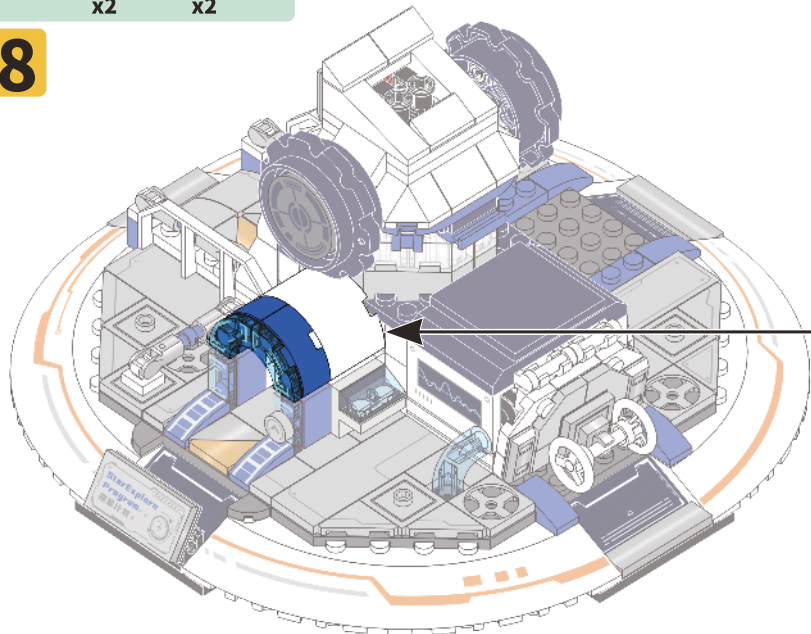

79

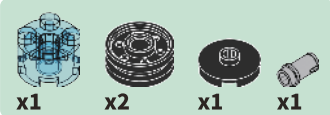
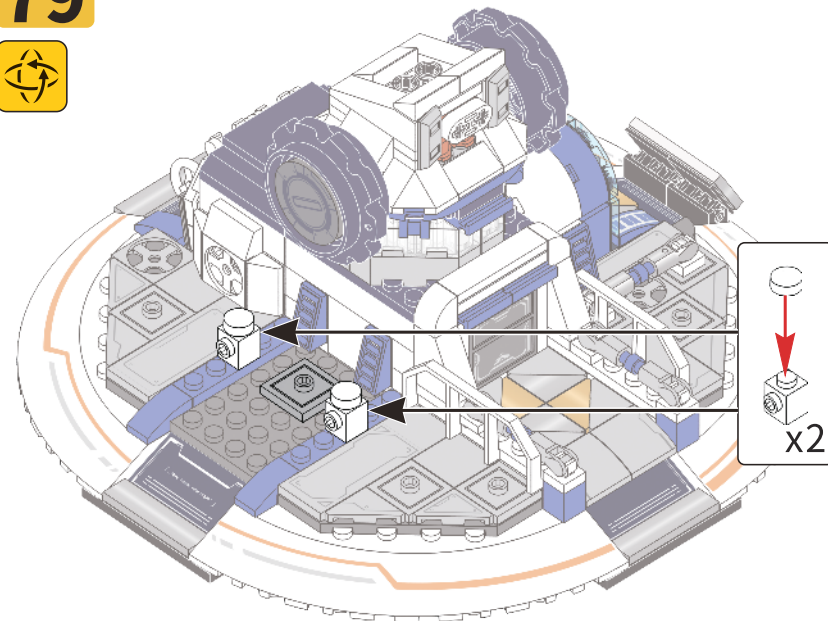

80

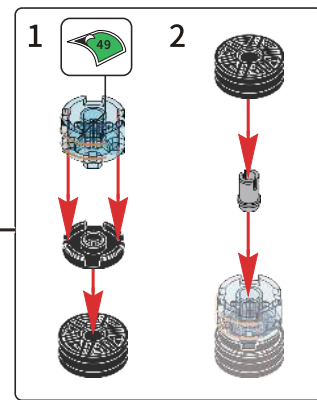
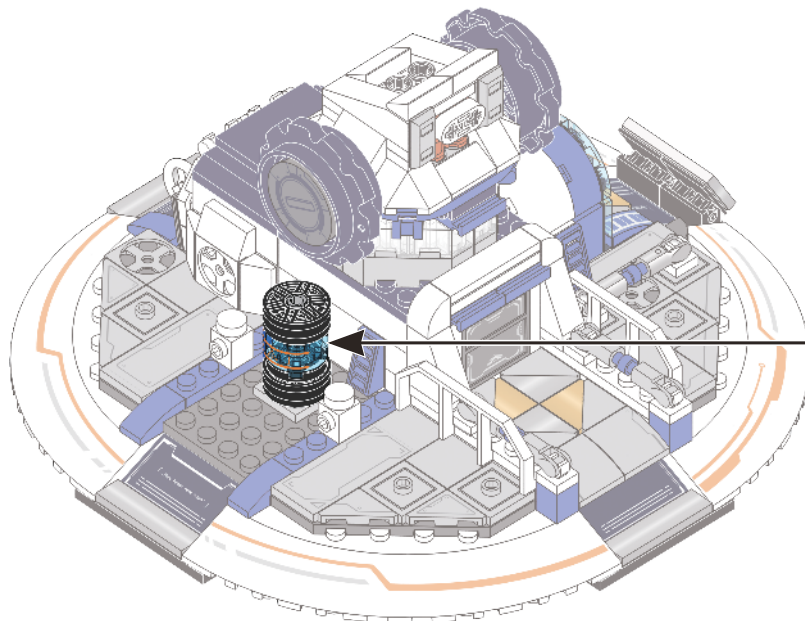

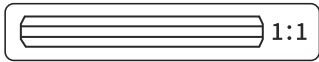
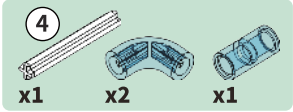

81

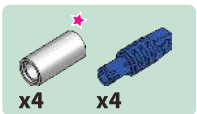
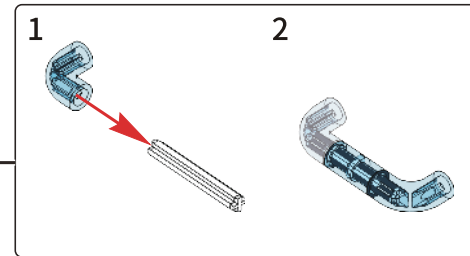
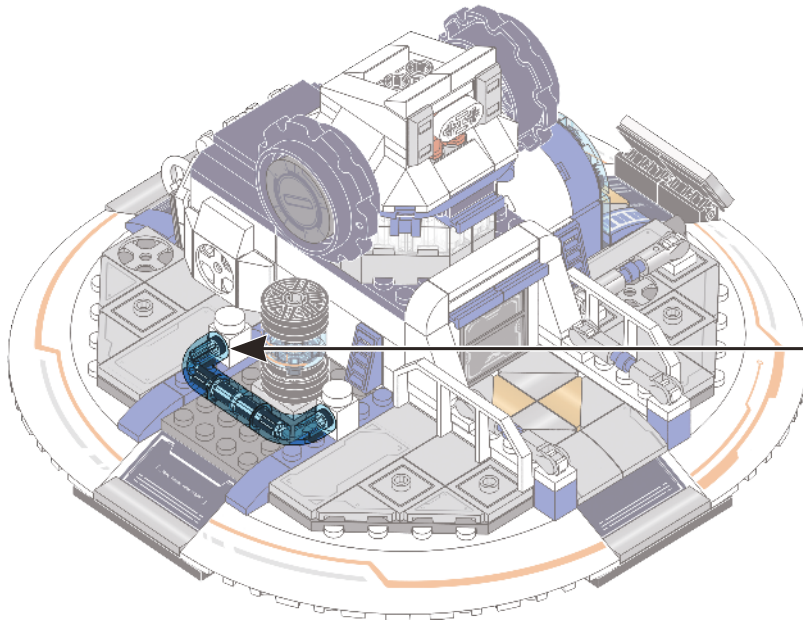

82

24

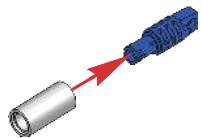

x4

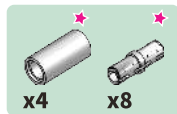

83

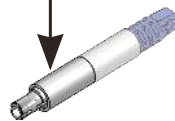
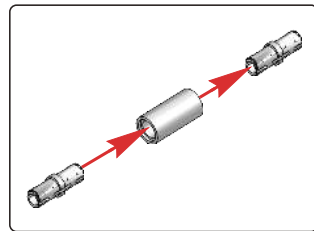

x4

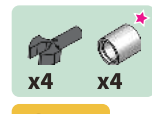

84

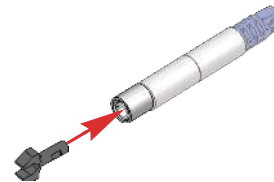

x4



85

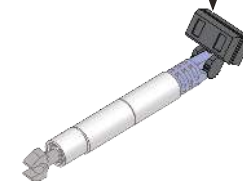
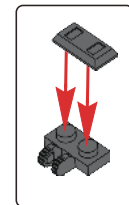

x4

86

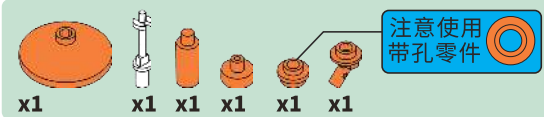
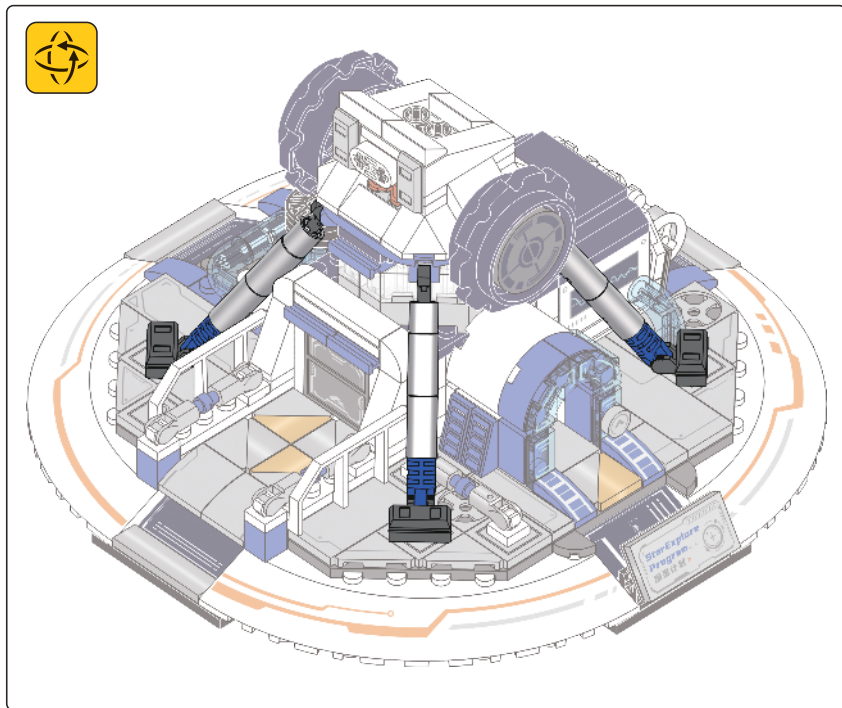

87

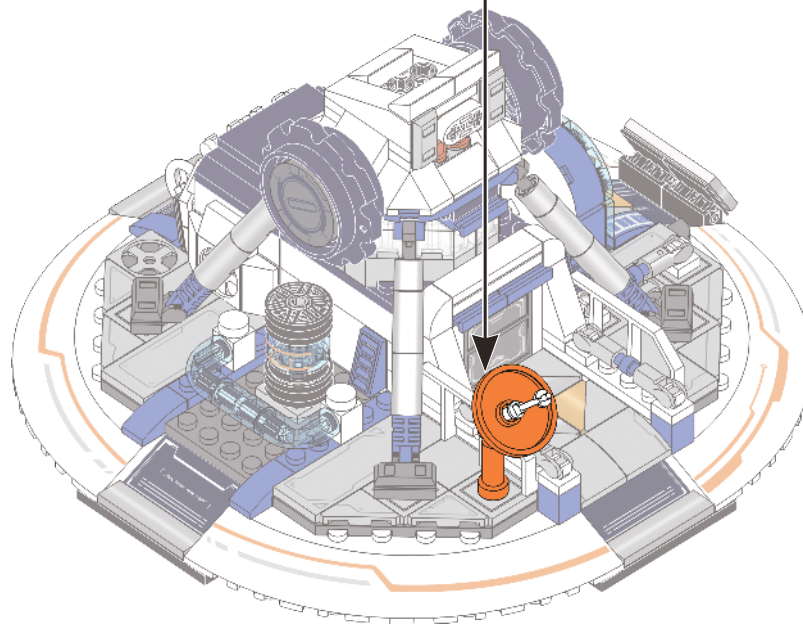
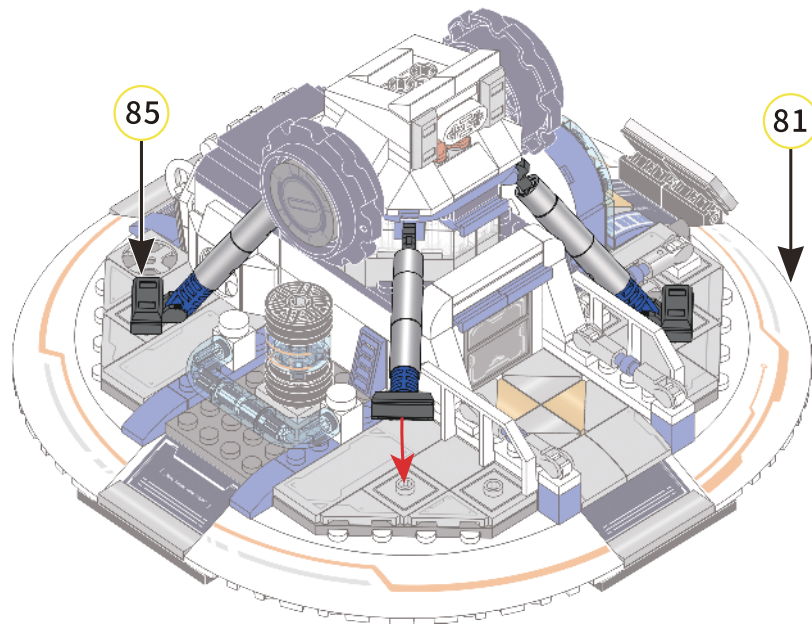
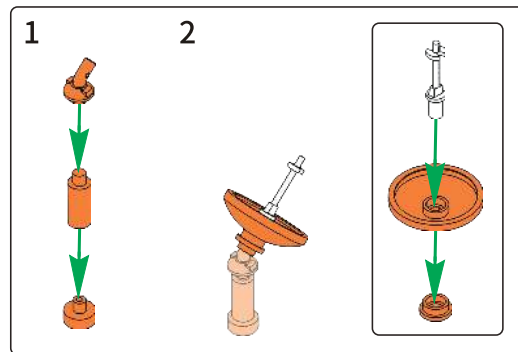

3

Particle bag No.3
3号颗粒袋

Completed drawing of
NO.3 granule bag
3号颗粒袋
完成图

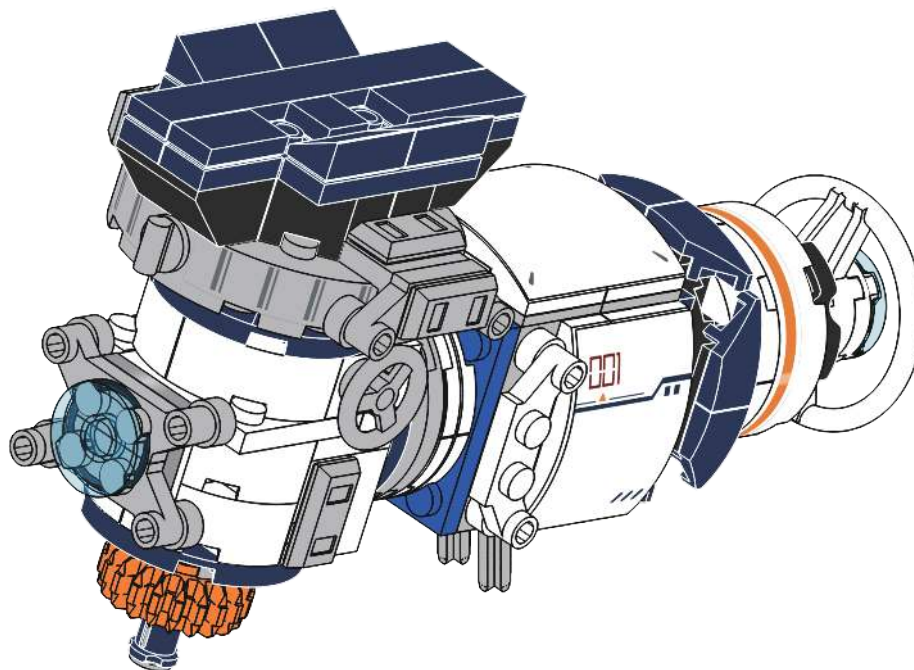

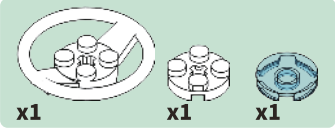

88

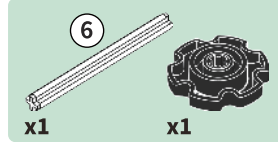
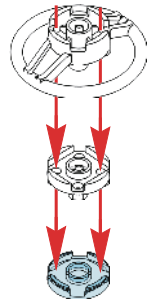

89

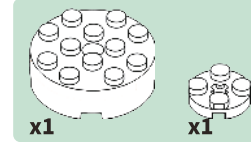
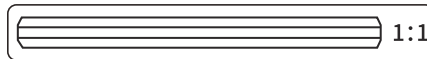
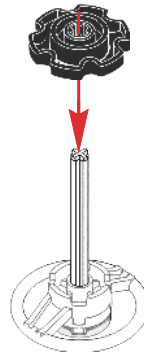

90

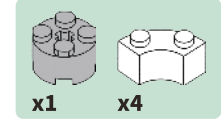
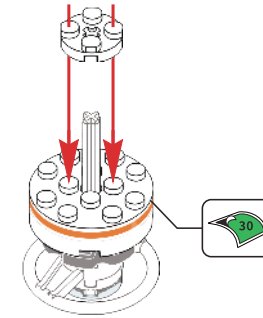

91

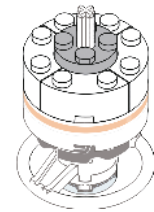

92

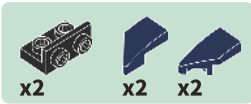
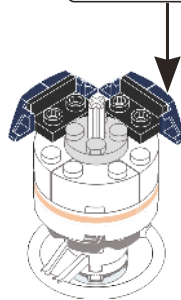
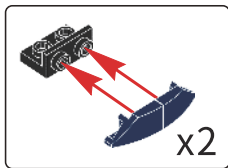

93

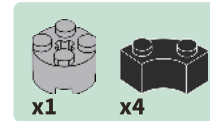
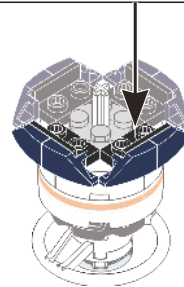
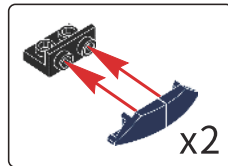

94

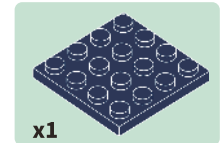
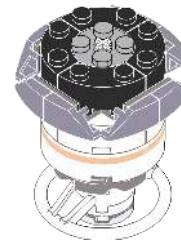

95

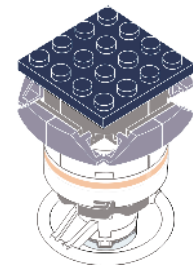

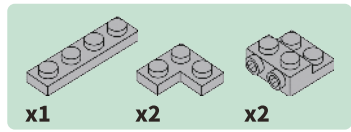

96

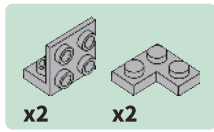
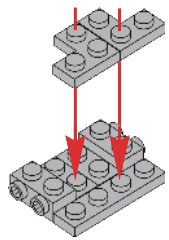

97

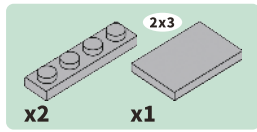
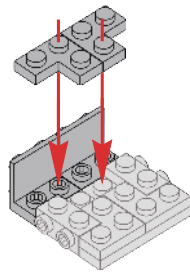

98

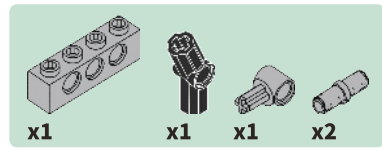
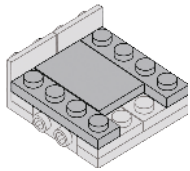

99

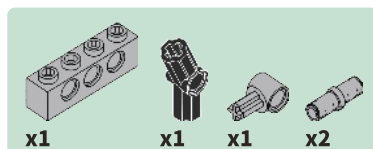
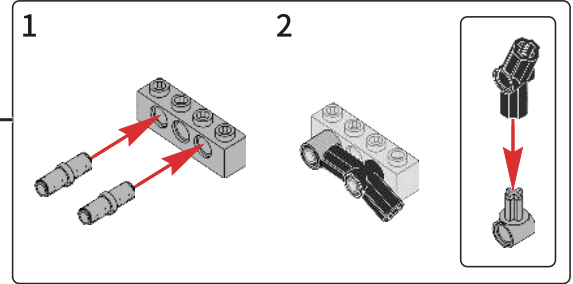

100

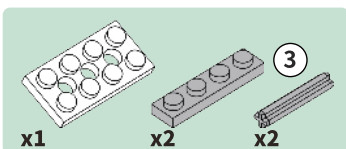
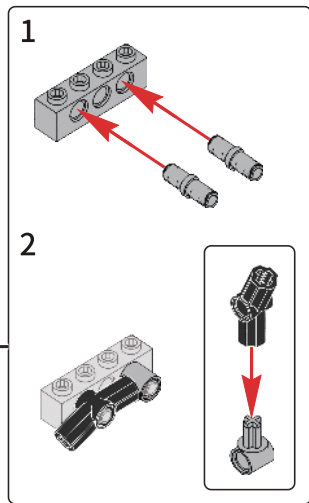
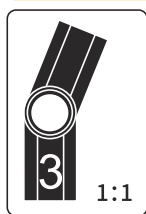

101

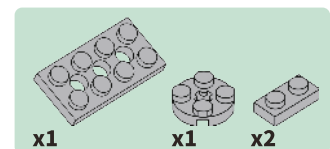
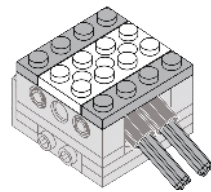
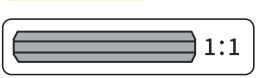

102

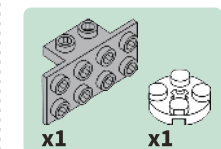
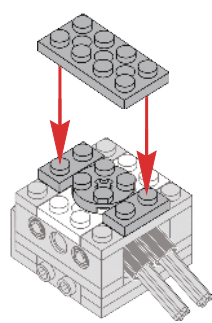

103

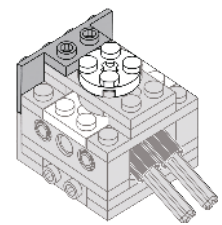

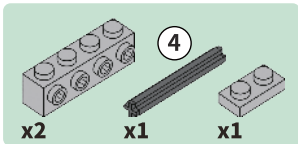

104

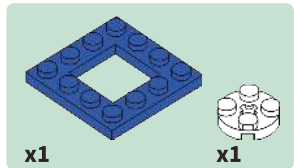
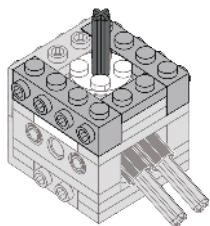

105

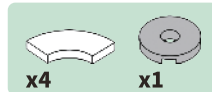
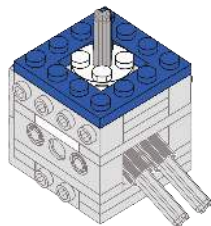

106

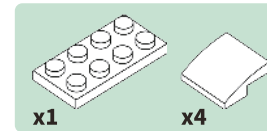
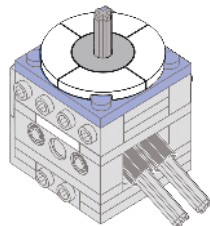

107

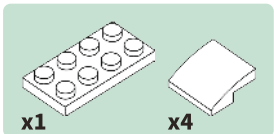
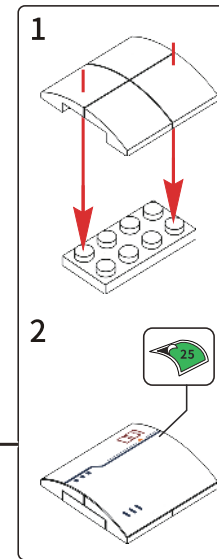
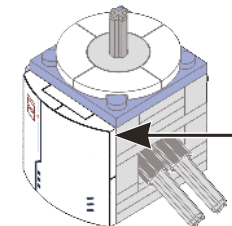

108

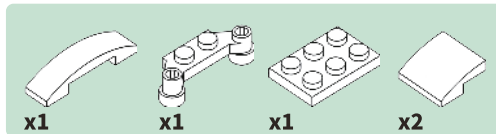
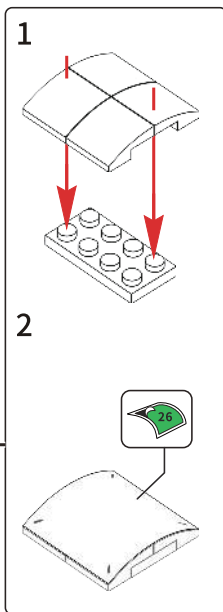
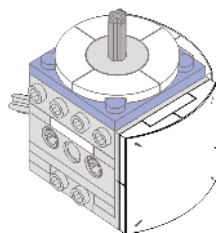

109

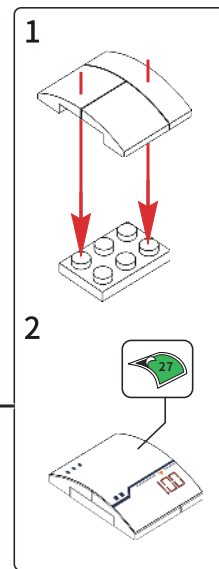
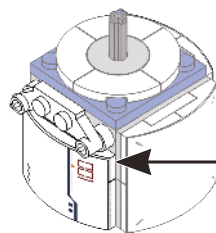

110

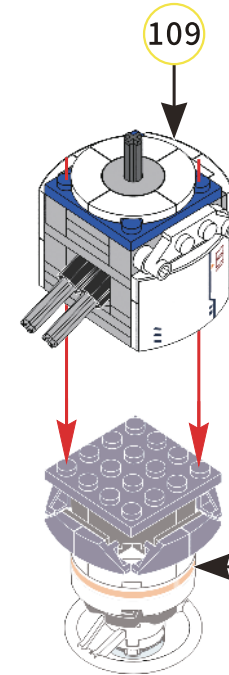

95

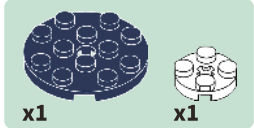

x1 x1

111

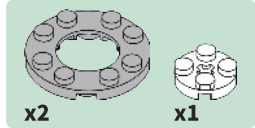

x2 x1

112

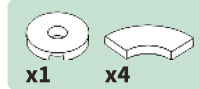
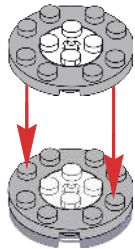

x1 x4

113

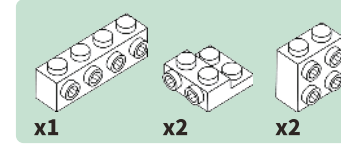
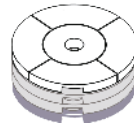

x1 x2 x2

114

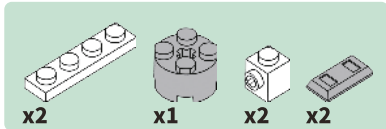
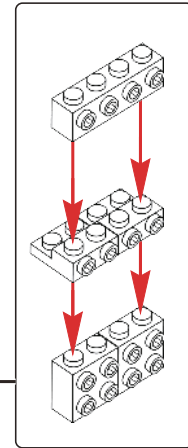
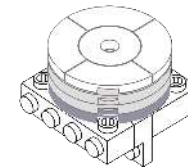

x2 x1 x2 x2

115

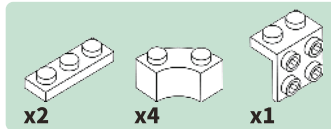
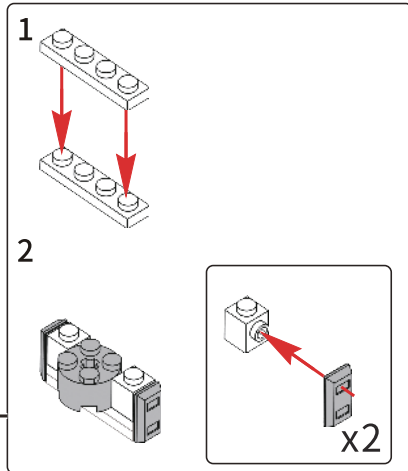

x2 x4 x1

116

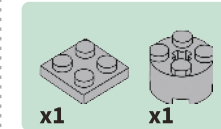
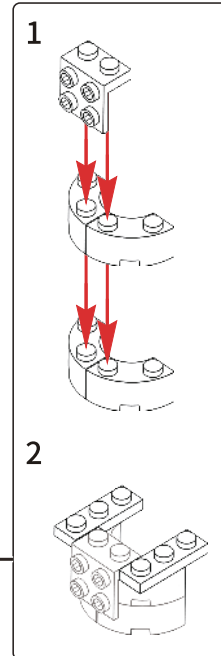
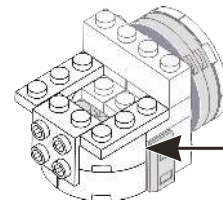

x1 x1

117

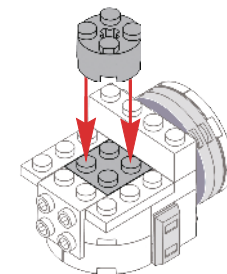

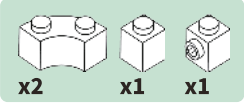

118

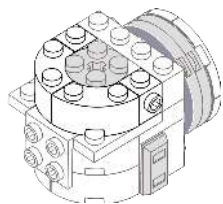

119

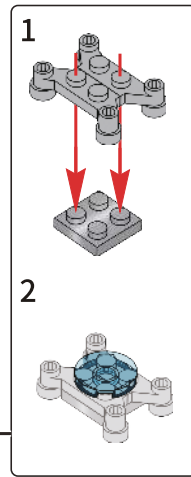
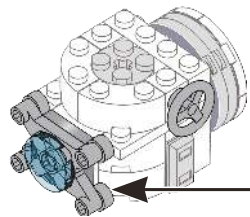

120

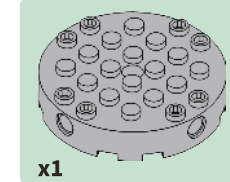
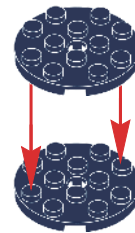

121

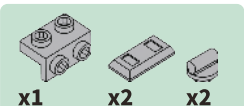
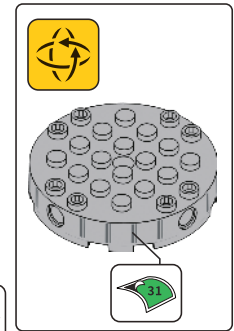
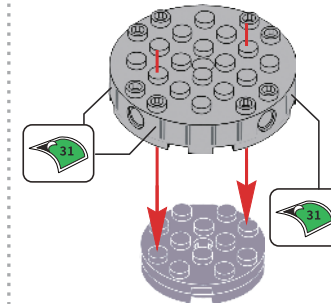

122

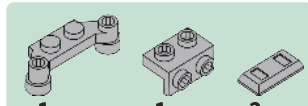
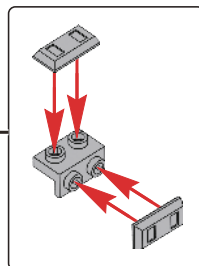
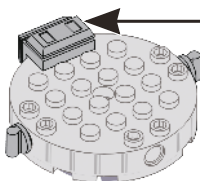

123

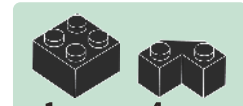
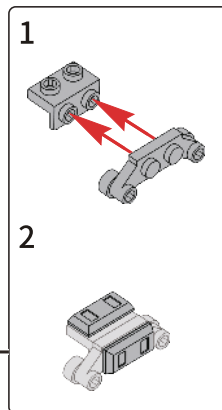
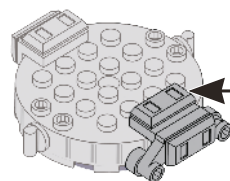

124

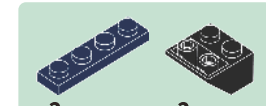
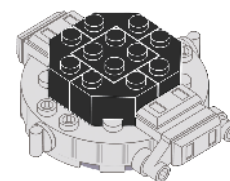

125

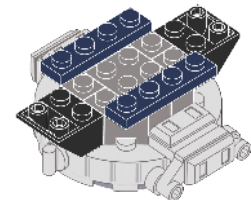

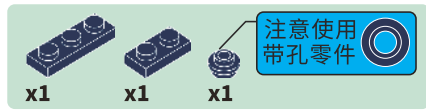

126

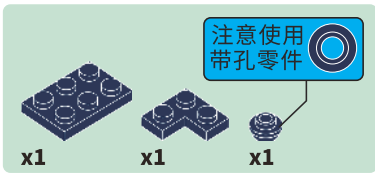
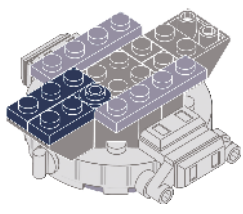

127

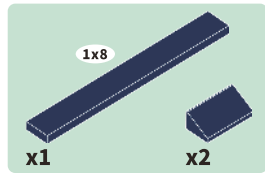
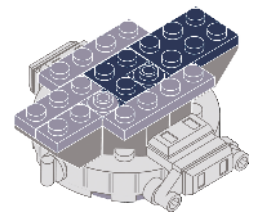

128

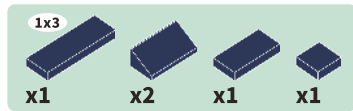
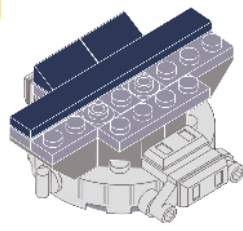

129

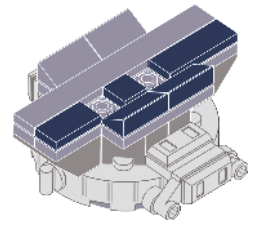

130

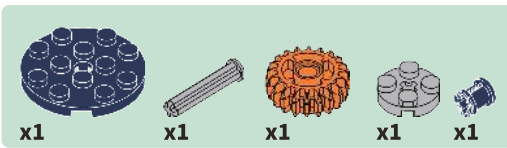
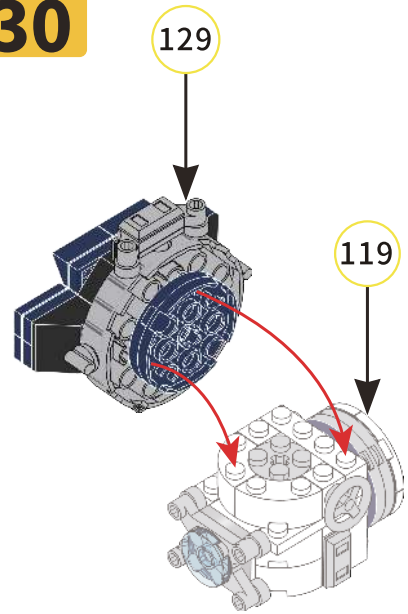

131

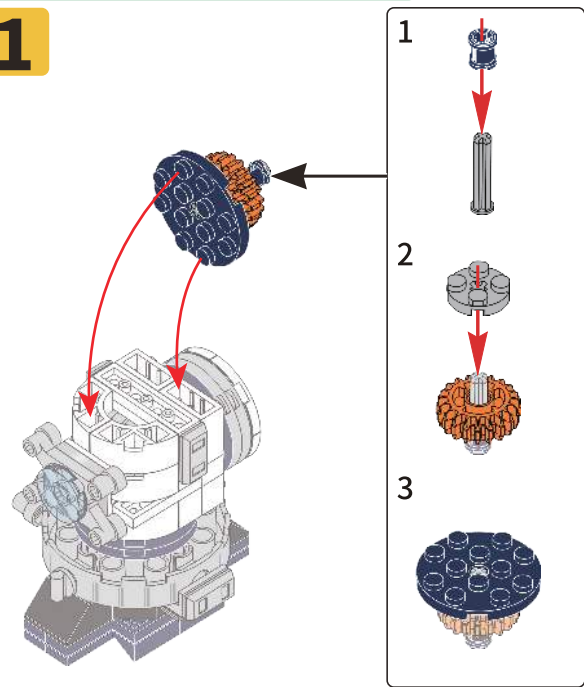

132

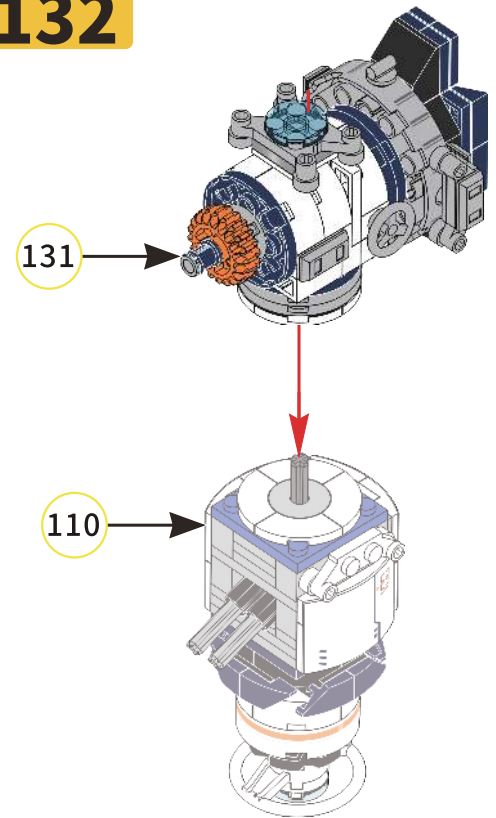

4

Particle bag No.4
4号颗粒袋

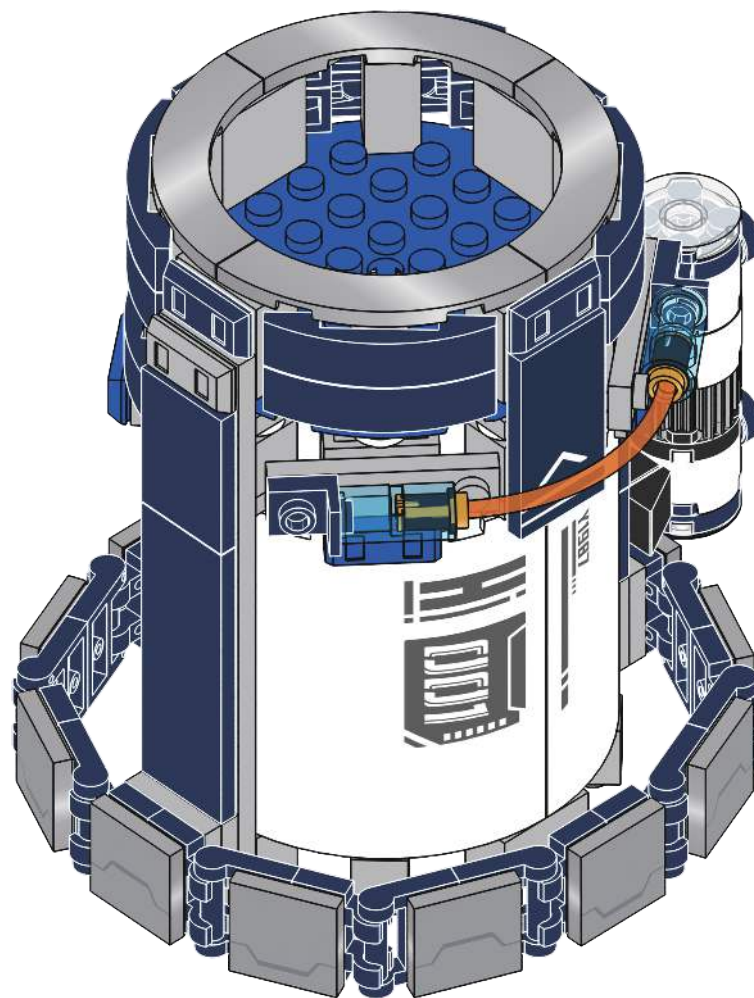

Completed drawing of
NO.4 granule bag

4号颗粒袋
完成图

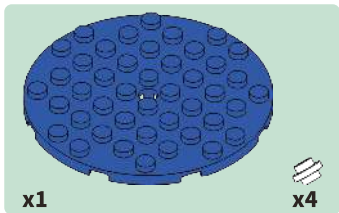

133

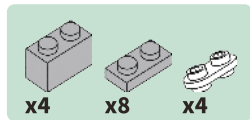
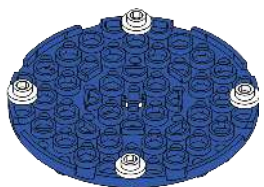

134

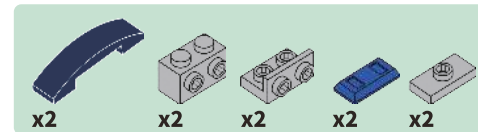
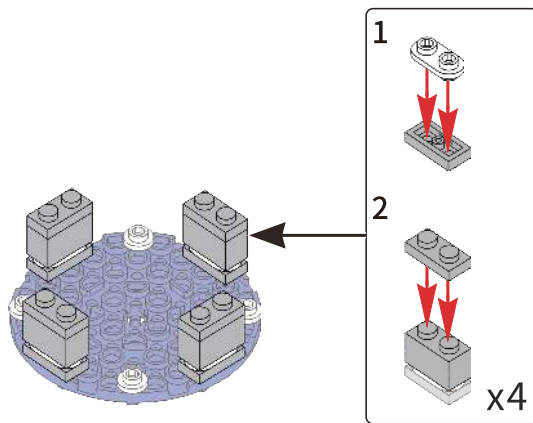

135

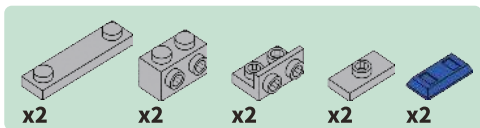
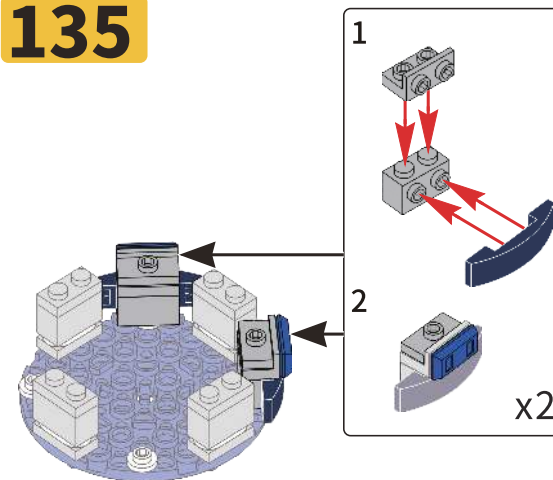

136

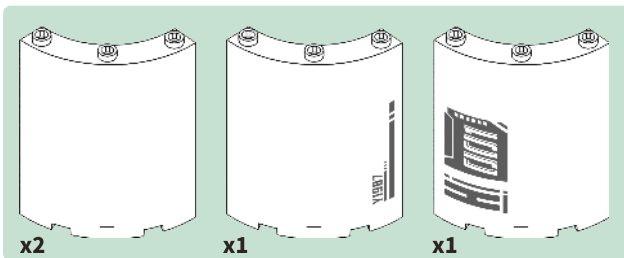
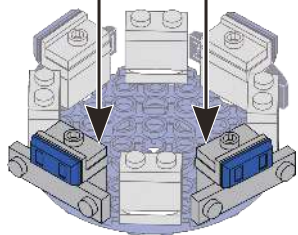
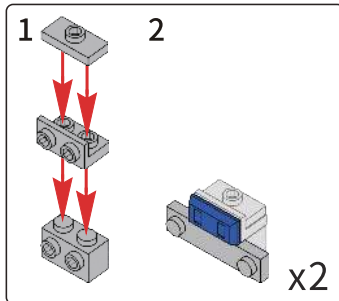

137

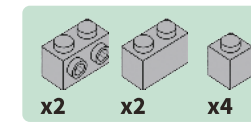
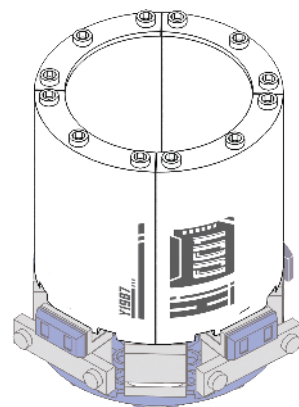

138

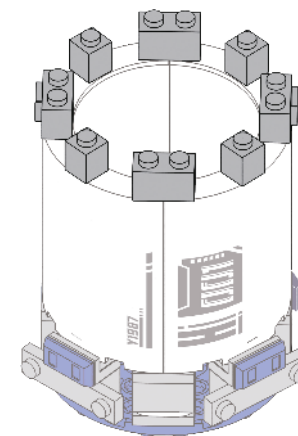

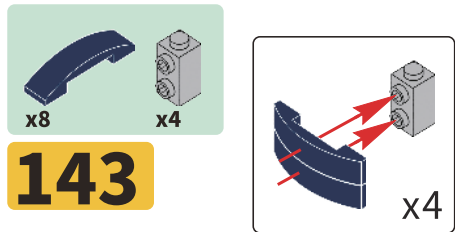

143

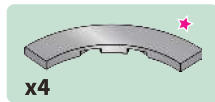
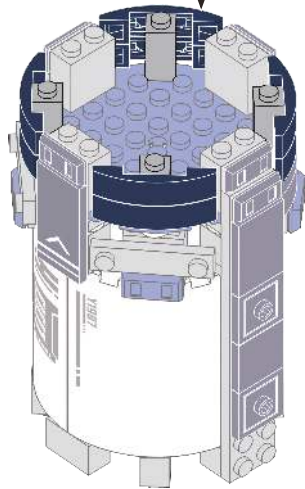
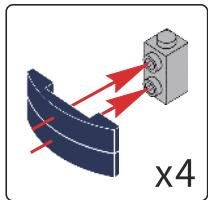

144

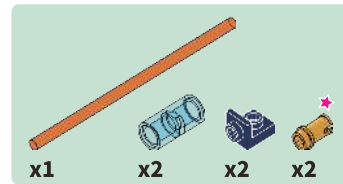
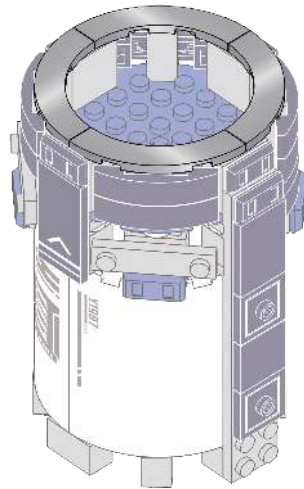

145

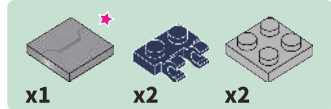
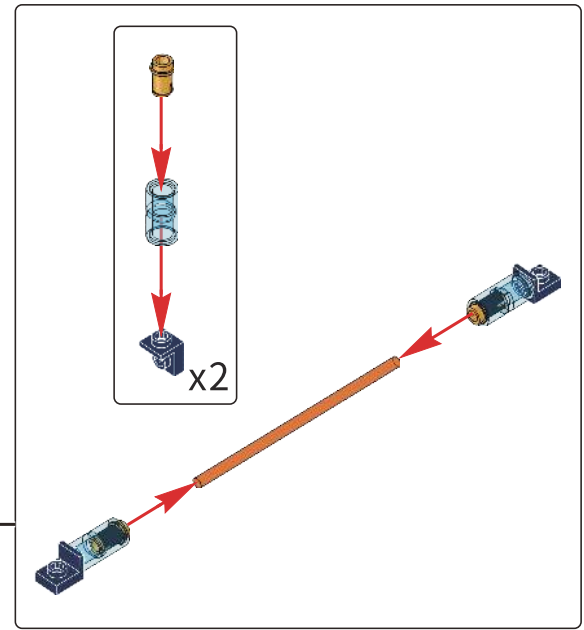
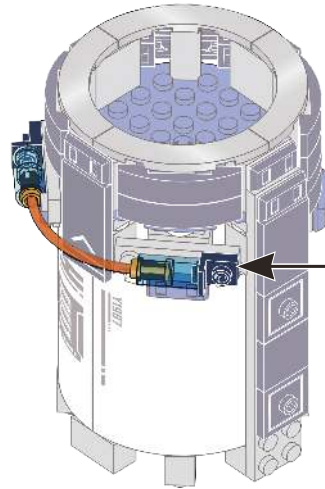

146

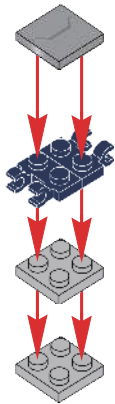

147

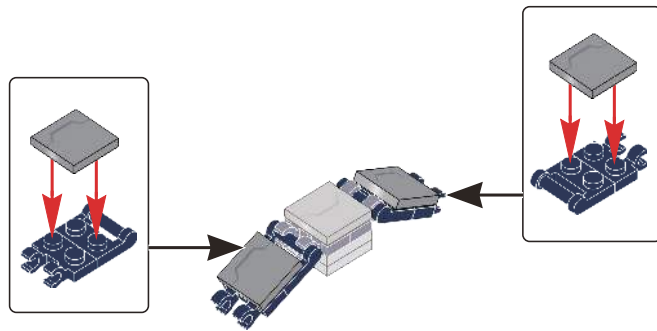

148

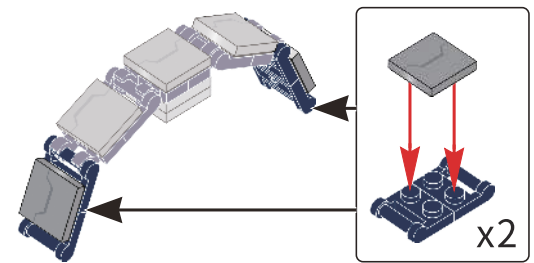

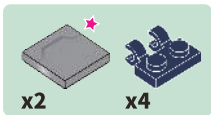

149

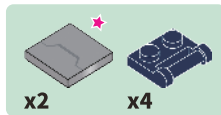
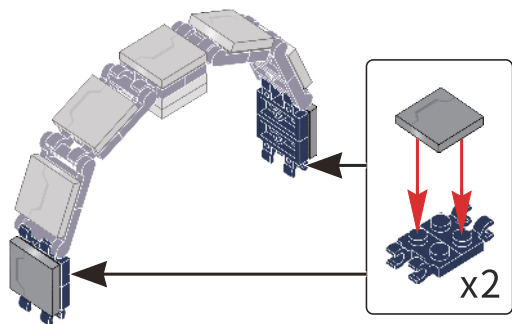

150

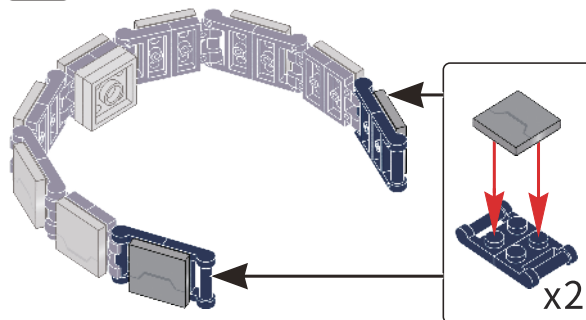

151

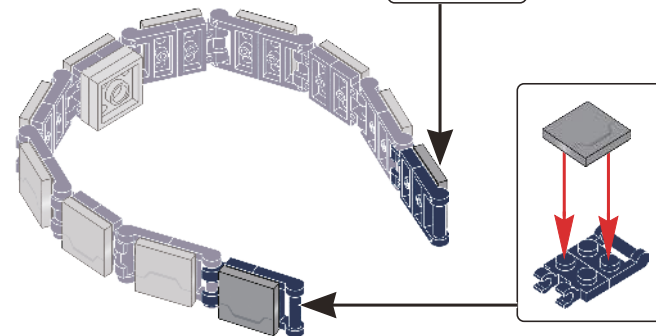
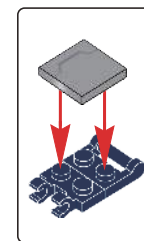

152

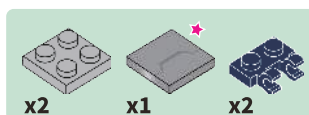
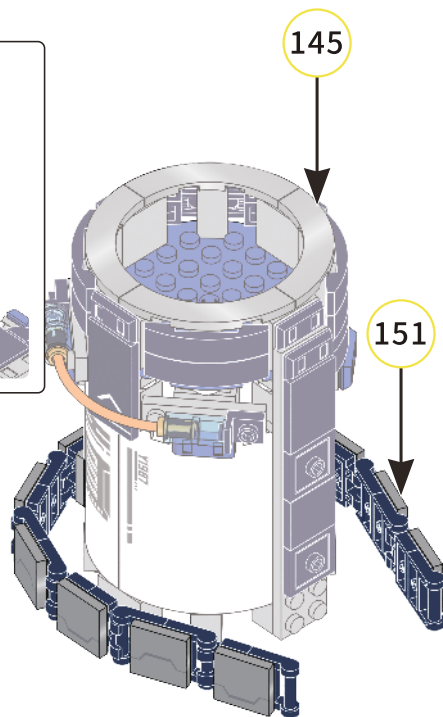
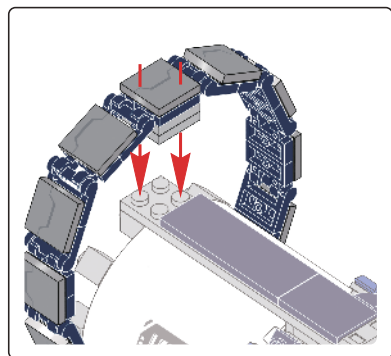

153

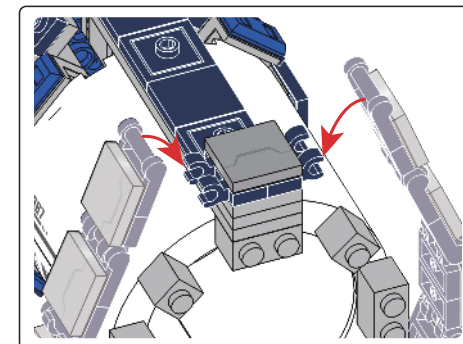
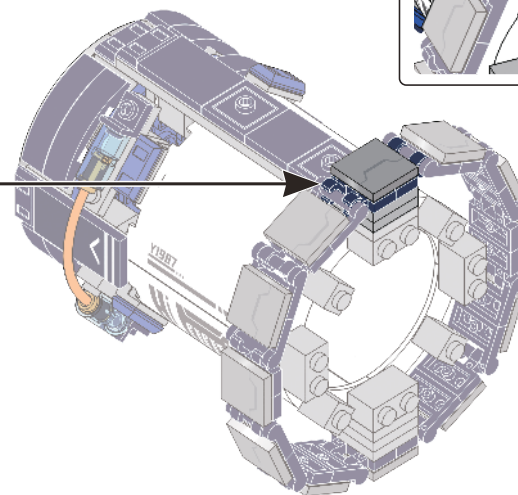
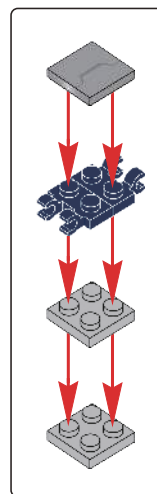

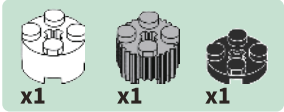

154



155

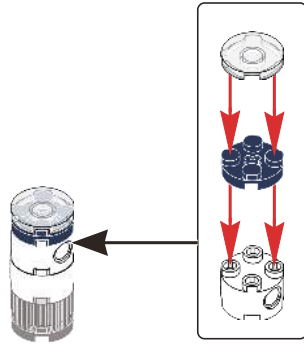

156

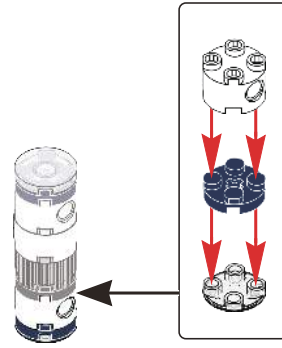

157

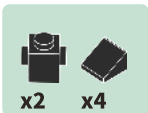
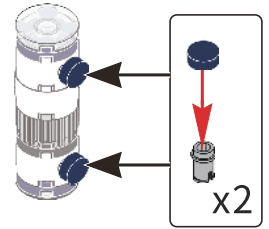

158

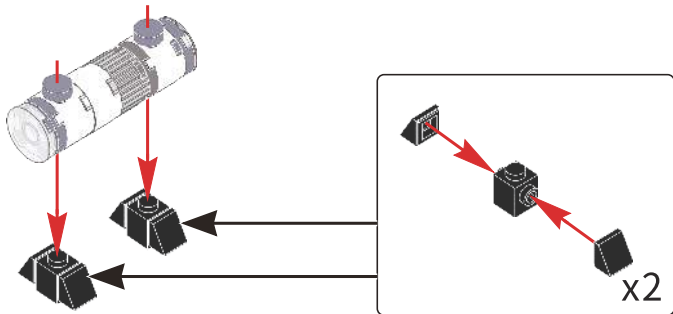

159

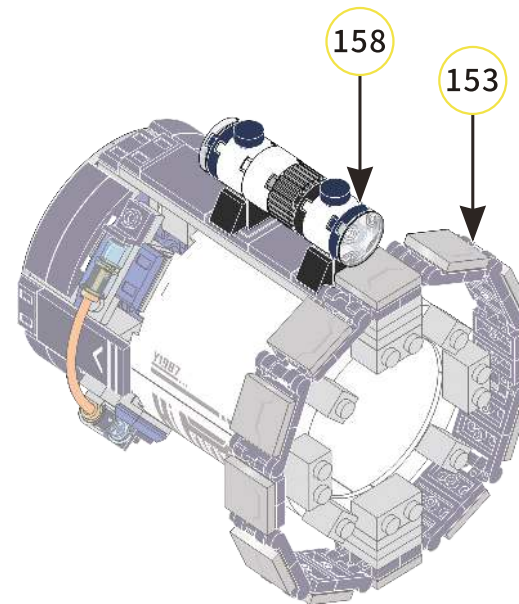

5

Particle bag No.5
5号颗粒袋

Completed drawing of
NO.5 granule bag
5号颗粒袋
完成图

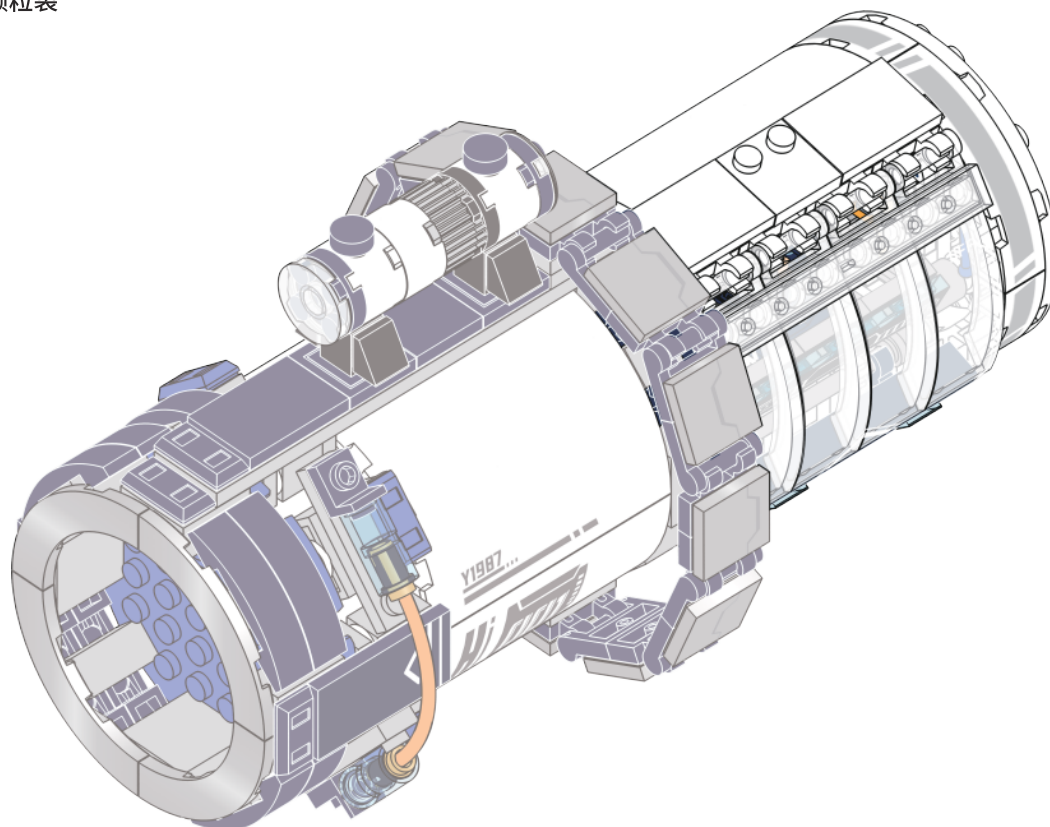

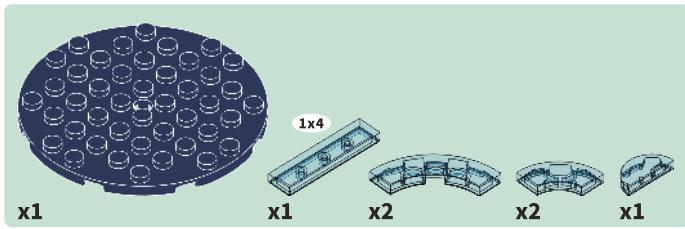

160

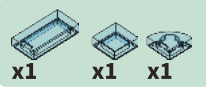
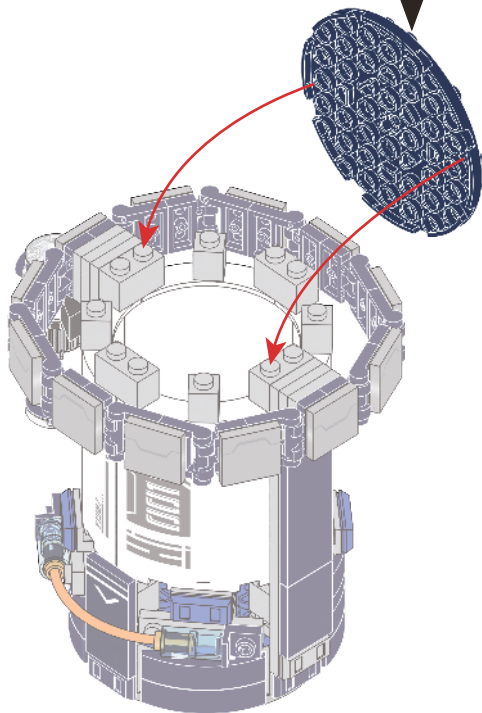
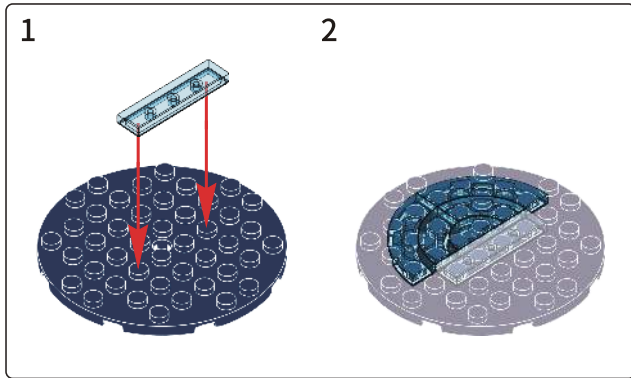
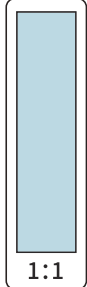

161

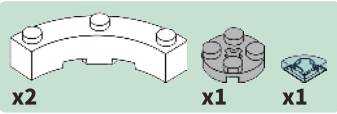
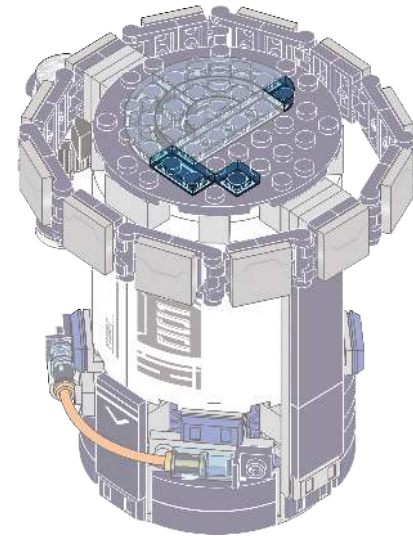

162

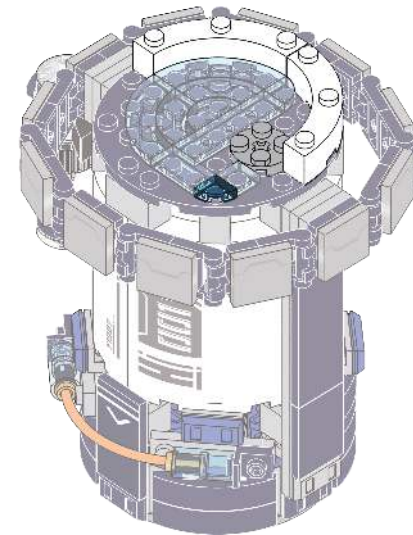

163

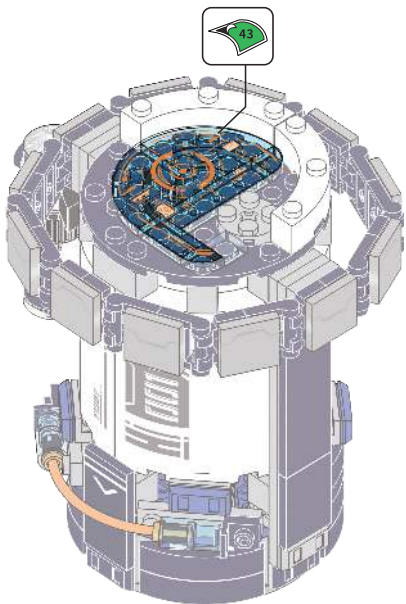

164

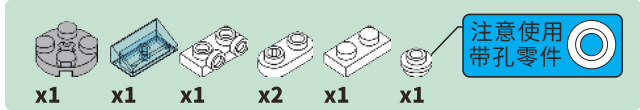

165

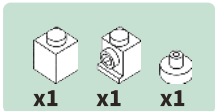
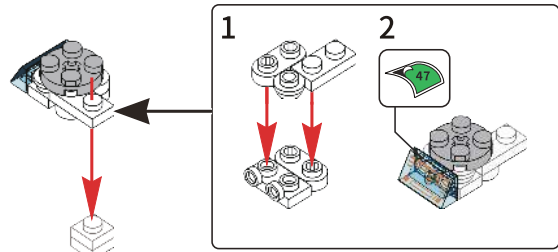
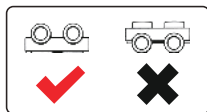

166

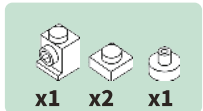
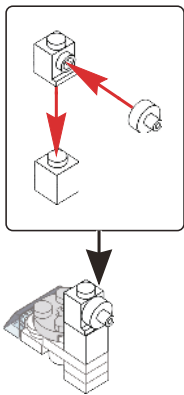

167

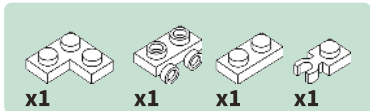
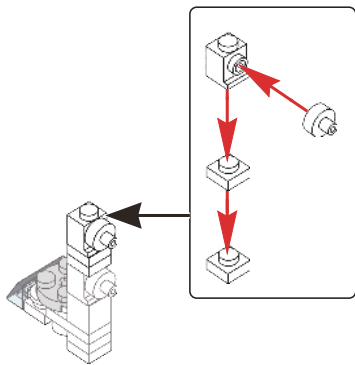

168

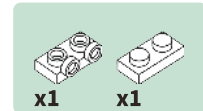
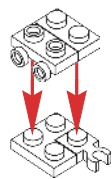
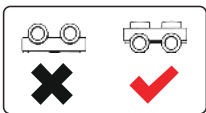

169

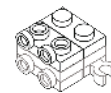
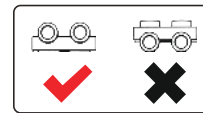

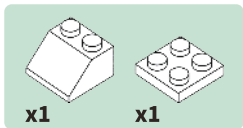

170

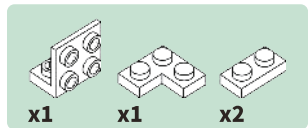
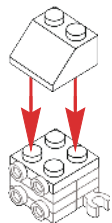

171

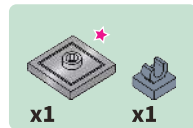
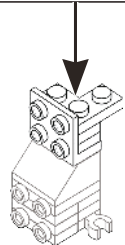
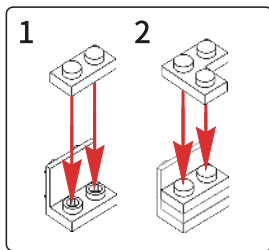

172

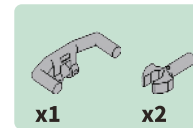
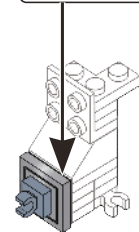
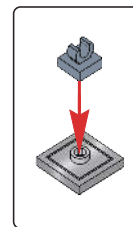

173

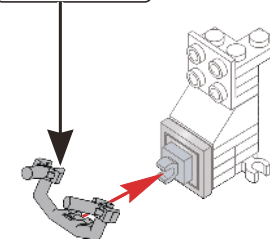
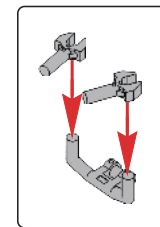

174



173

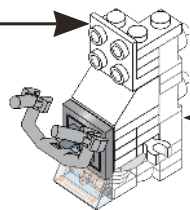

167

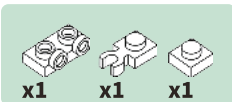

175

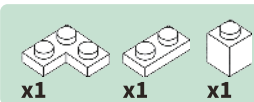
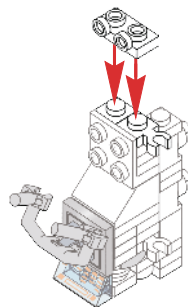

176

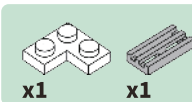
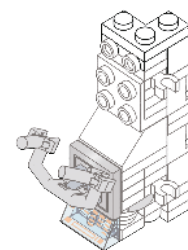
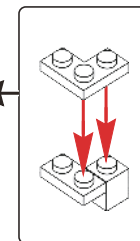

177

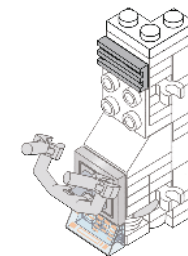

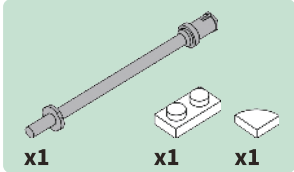

178

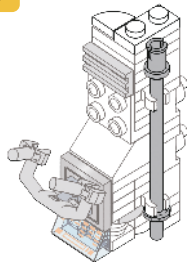

179

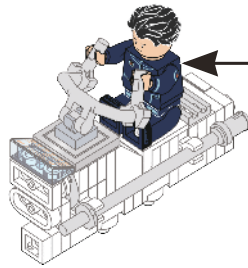

180

163

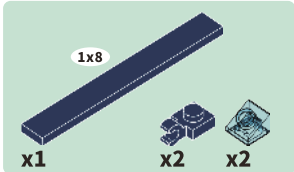
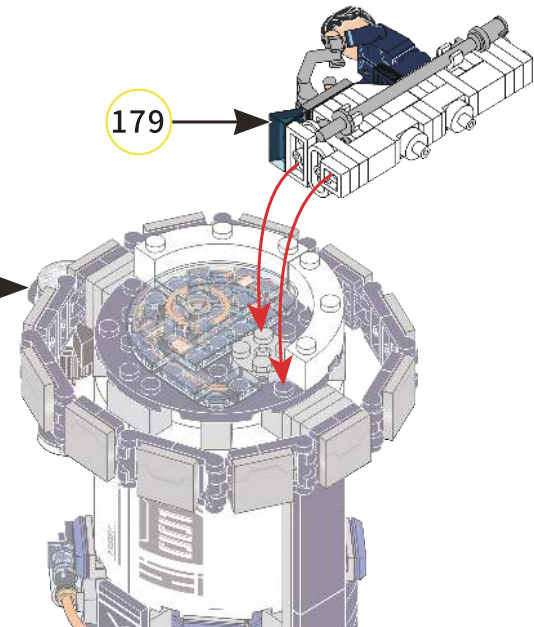

181

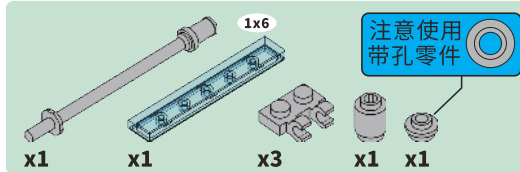
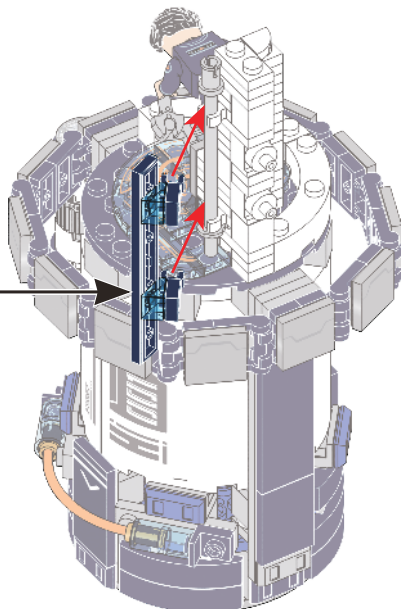
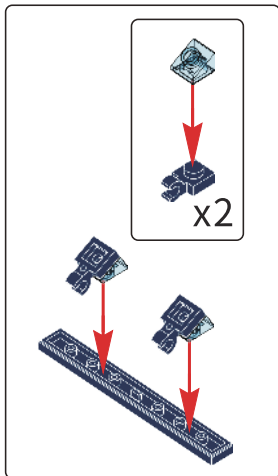

182

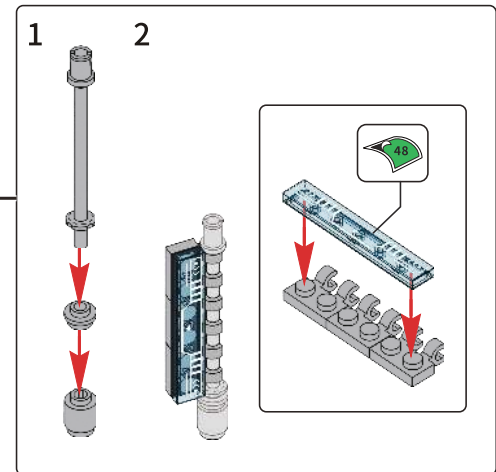
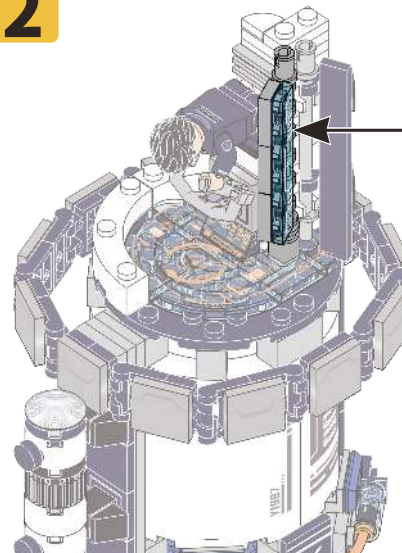

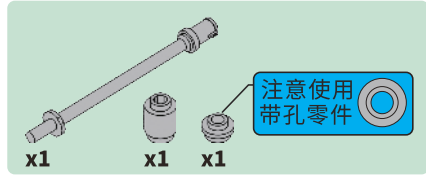

183

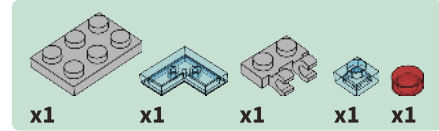

184

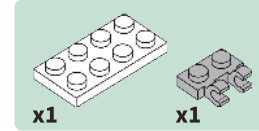
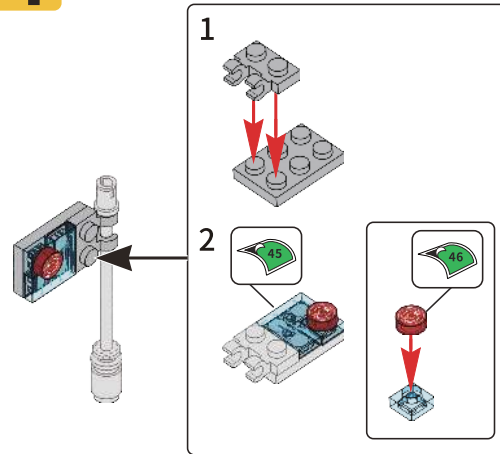

185

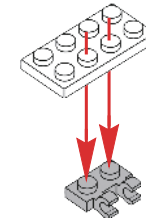

186

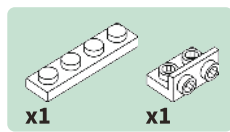
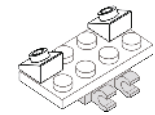

187

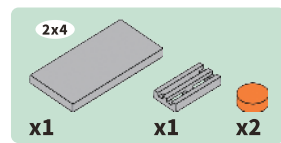
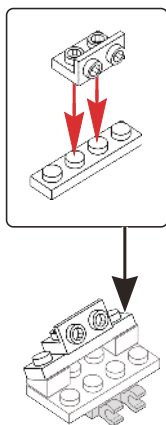

188

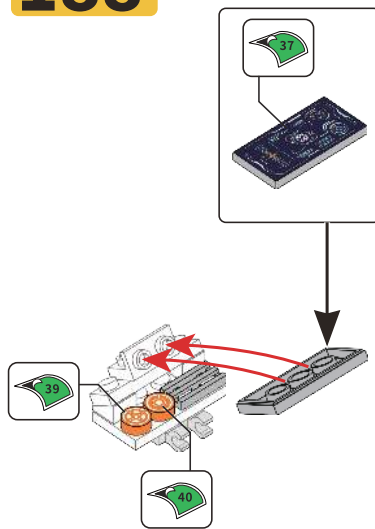

189

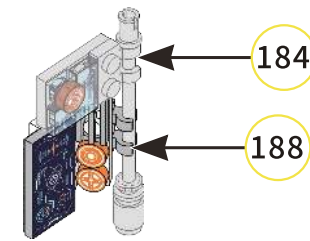

190

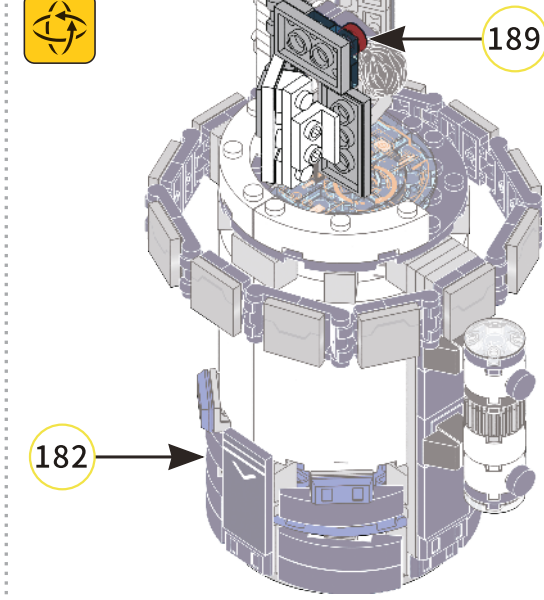

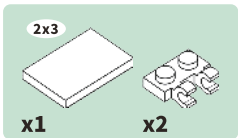

191

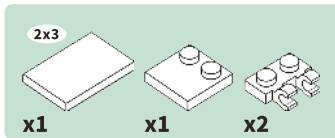
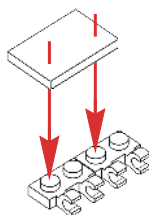

192

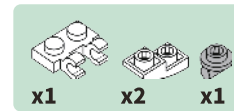
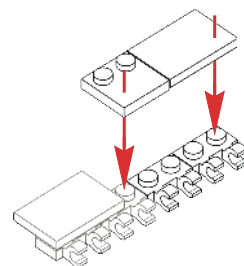

193

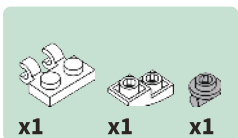
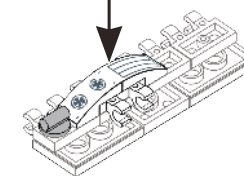
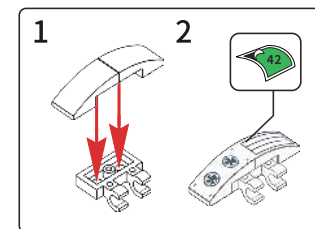

194

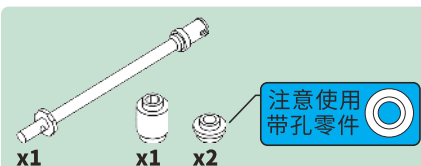
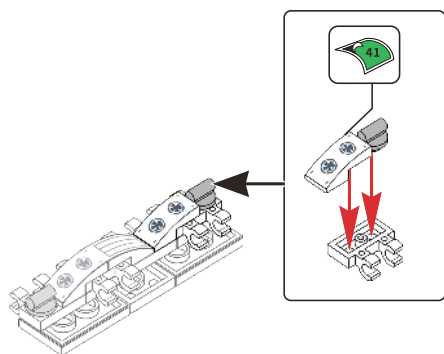

195

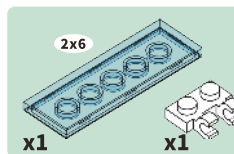
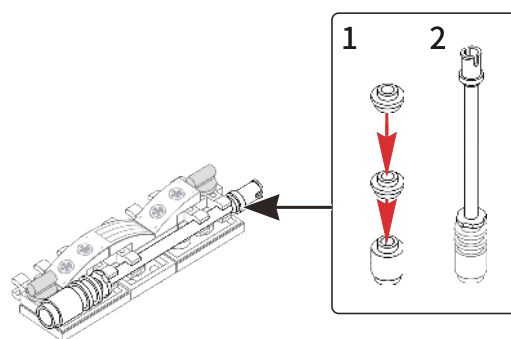

196

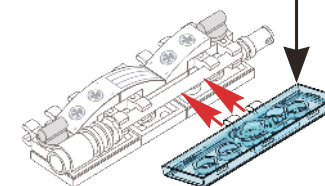
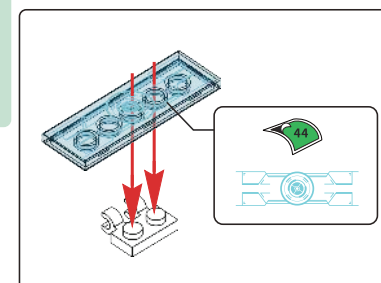

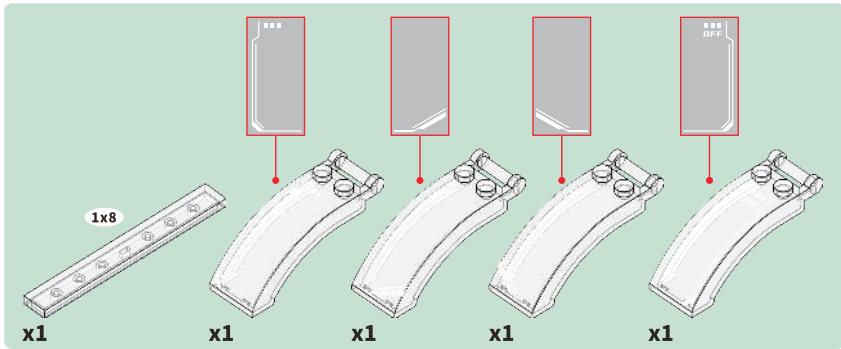

197

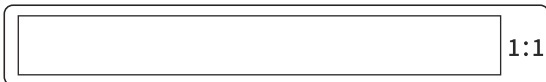
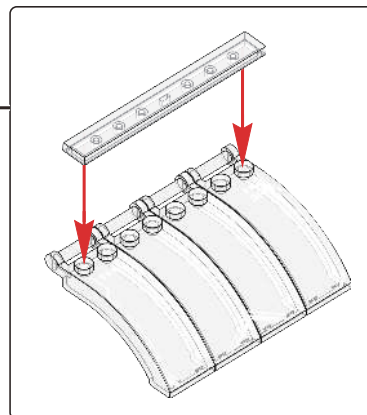
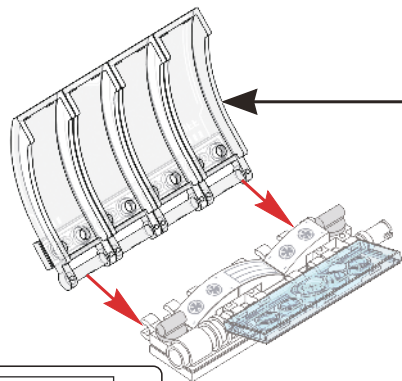

198

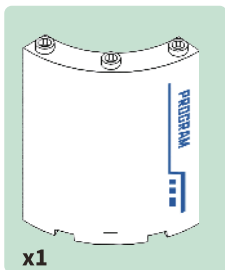
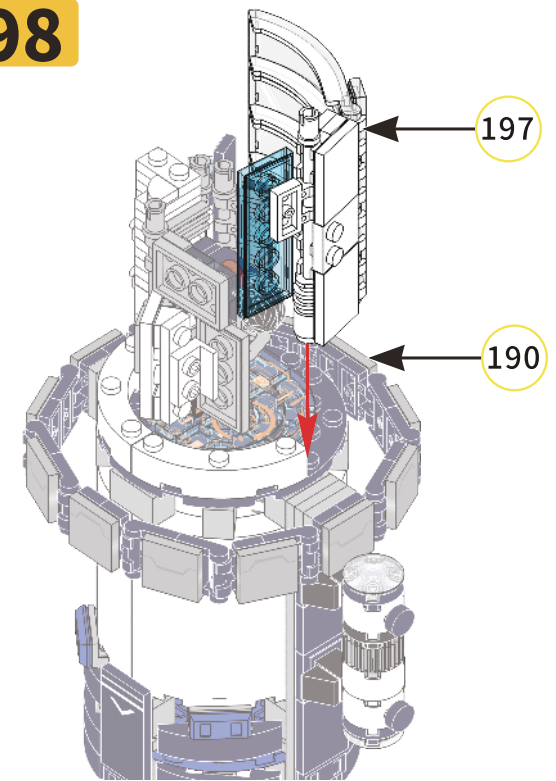

199

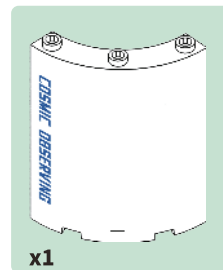
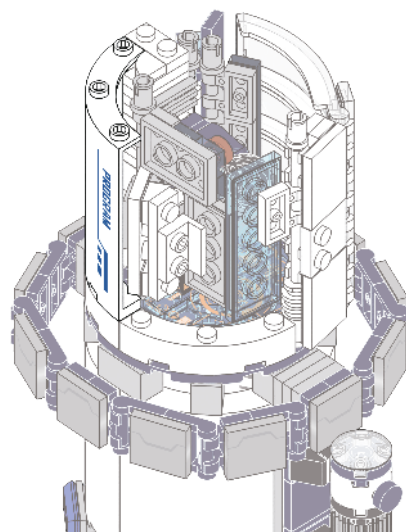

200

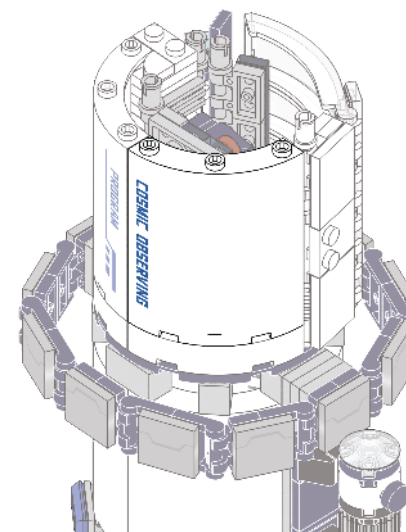



201

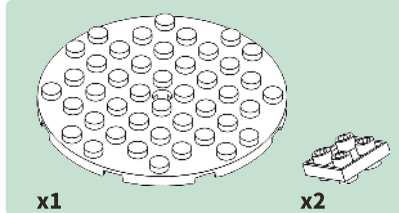
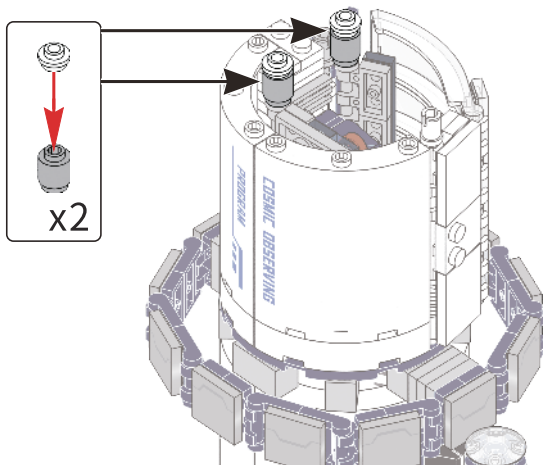

202

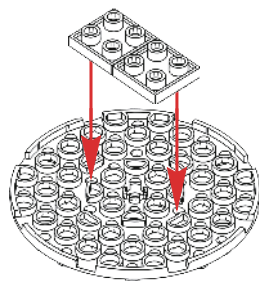

203

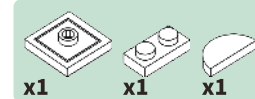
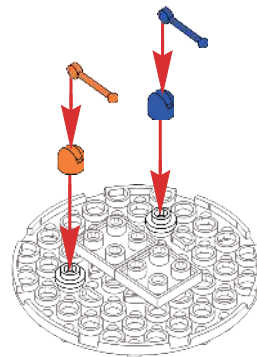

204

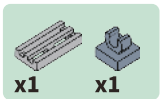
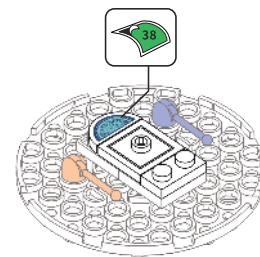

205

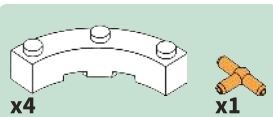
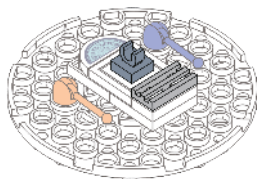

206

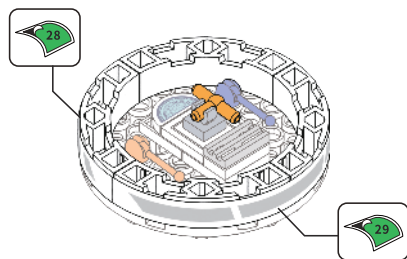
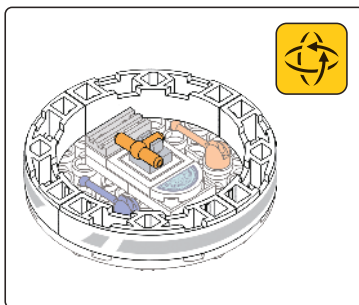

207

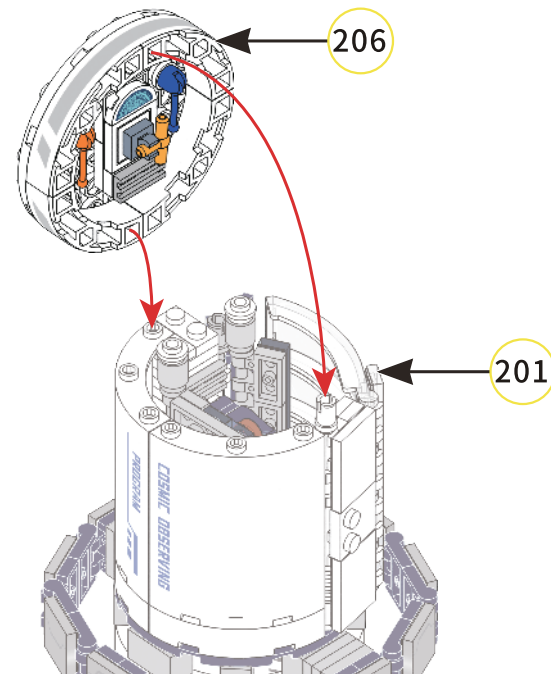

6

Particle bag No.6
6号颗粒袋

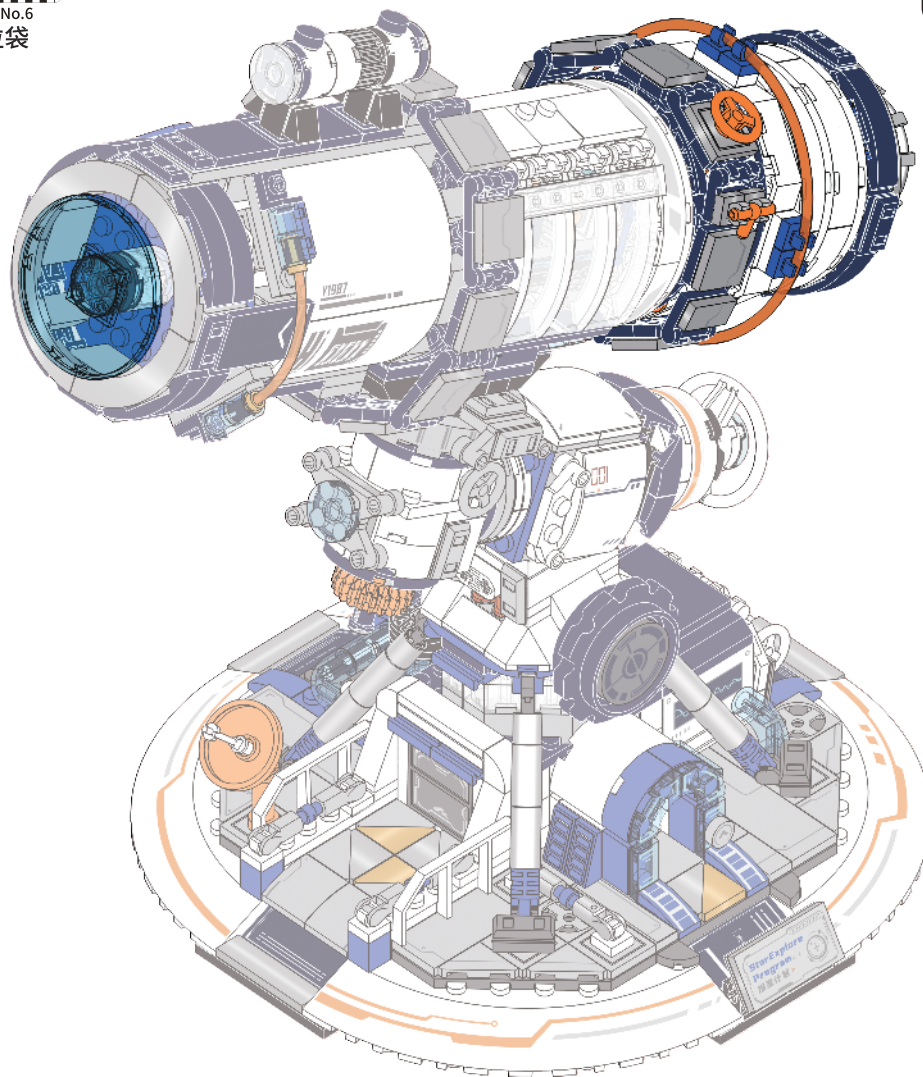

Completed drawing of
NO.6 granule bag

6号颗粒袋
完成图

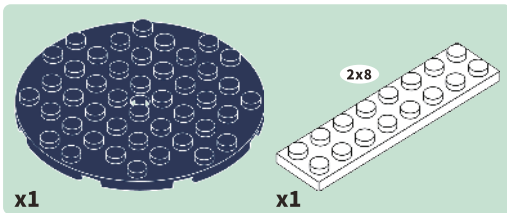

208

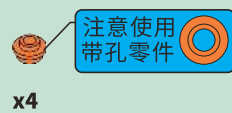
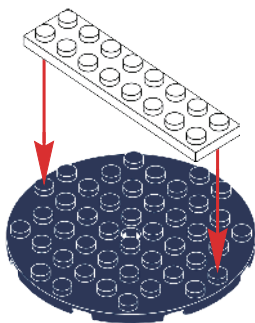

209

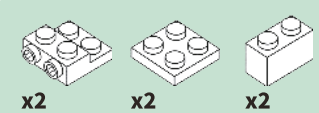
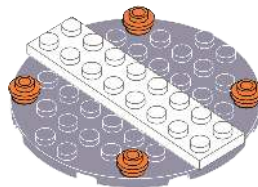

210

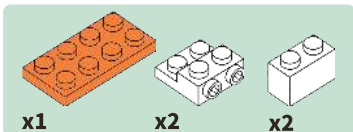
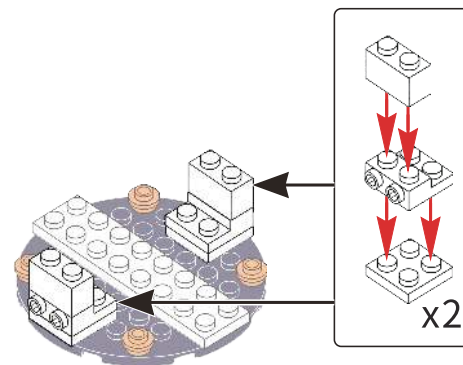

211

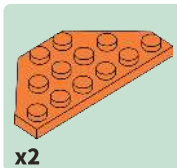
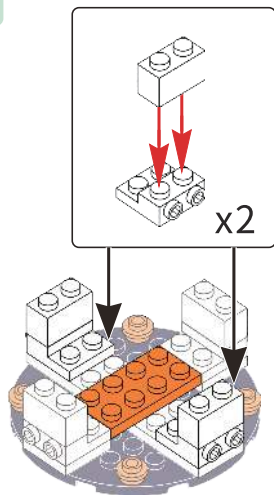

212

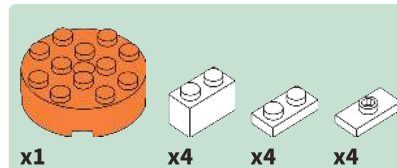
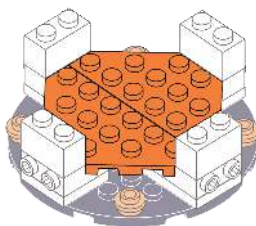

213

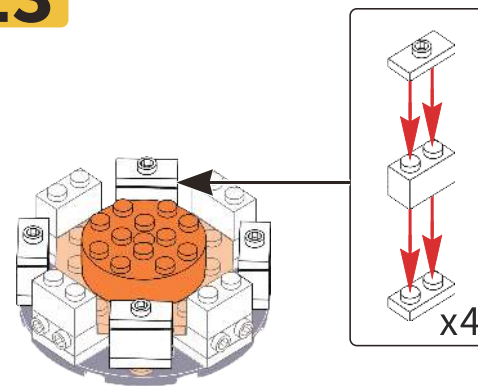

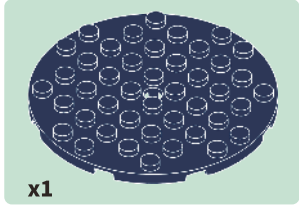

x1

214

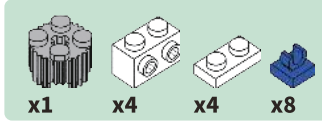
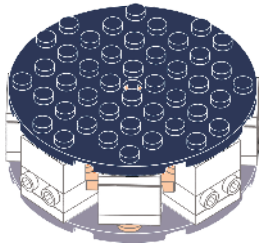

x1

x4

x4

x8

215

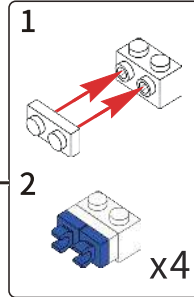
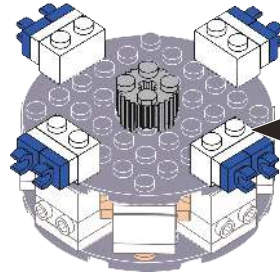

1

2

x4

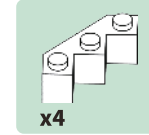

x4

216

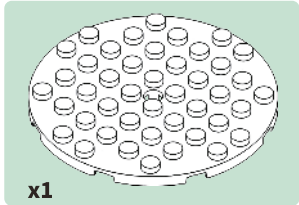
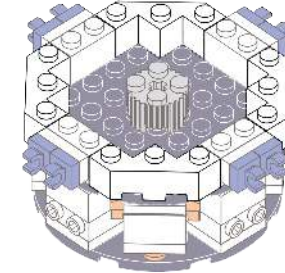

x1

217

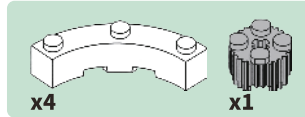
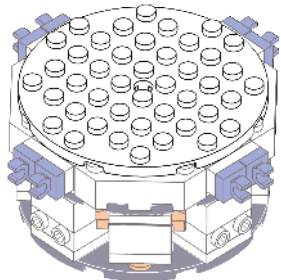

x4

x1

218

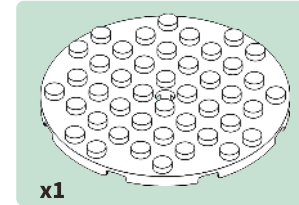
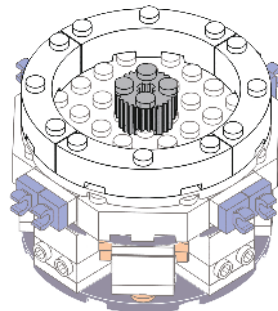

x1

219

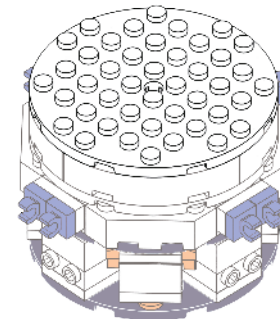

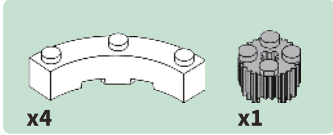

220

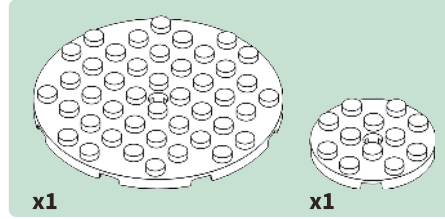
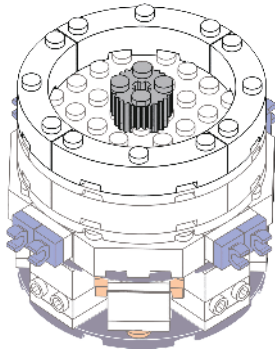

221

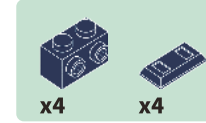
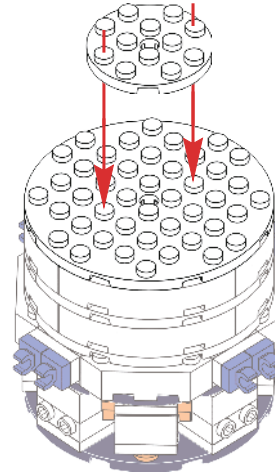

222

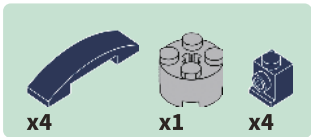
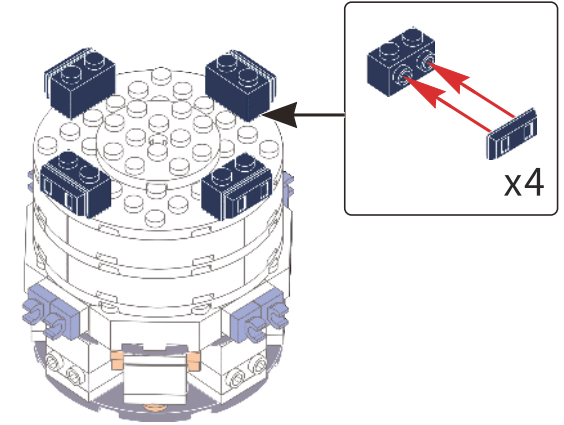

223

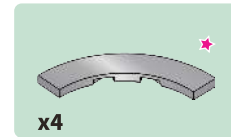
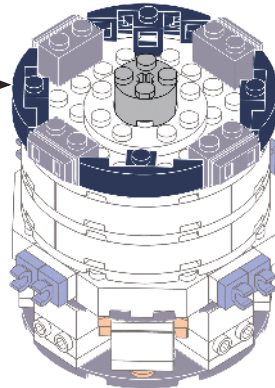
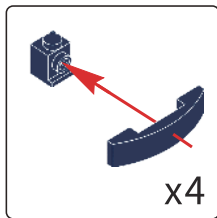

224

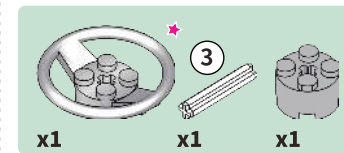
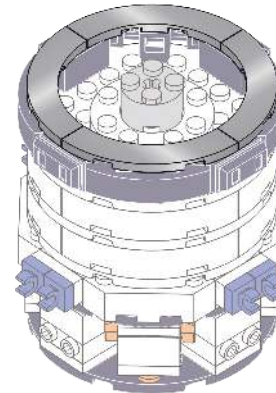

225

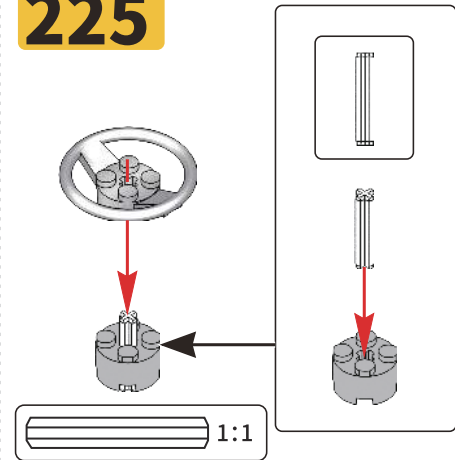

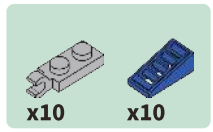

226

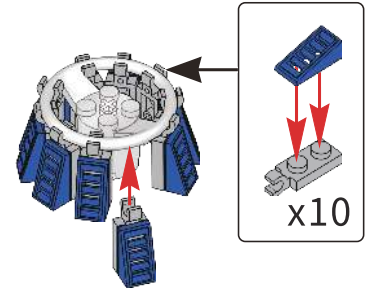

227

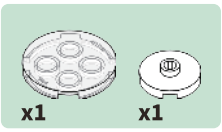
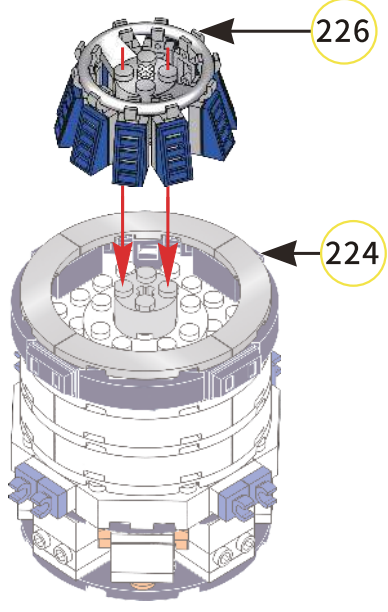

228

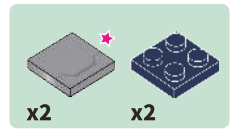
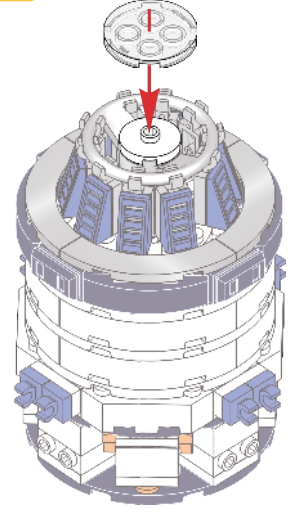

229

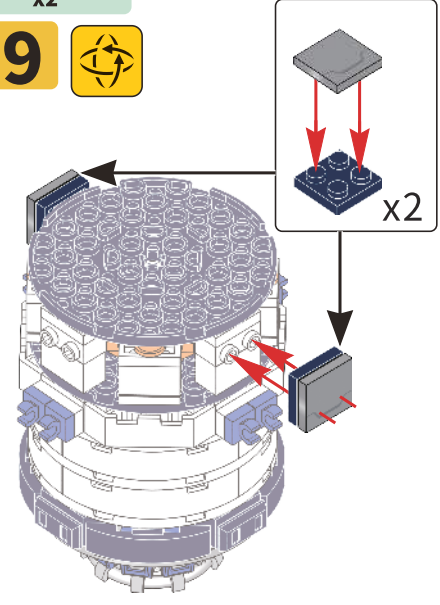

230

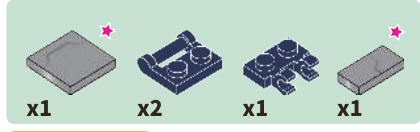
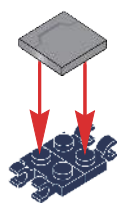

231

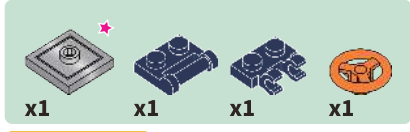
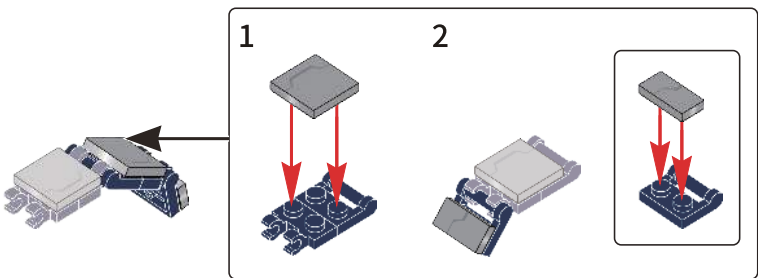

232

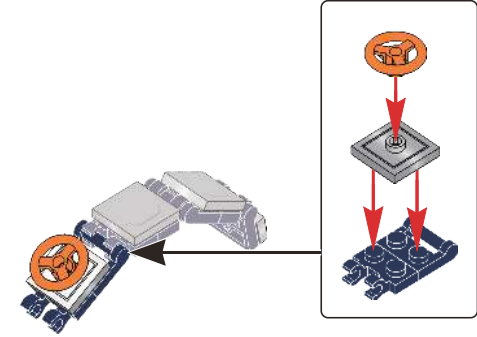

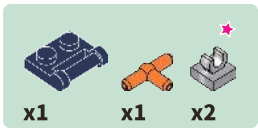

233

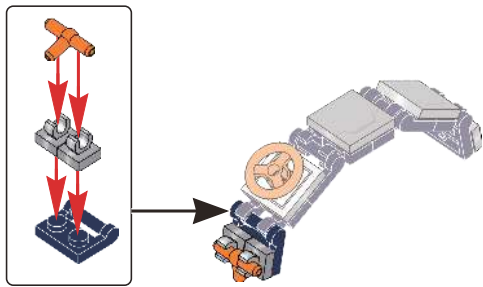

234

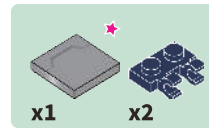
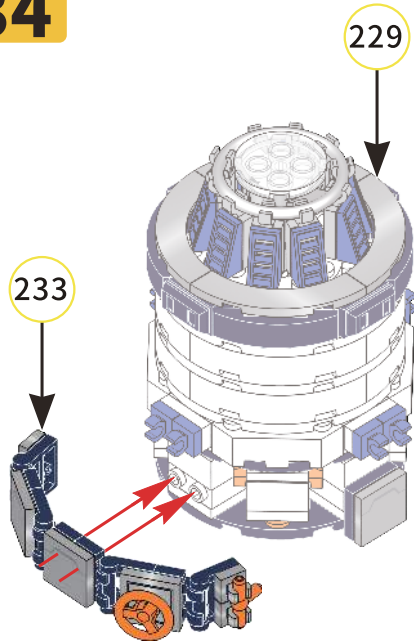

235

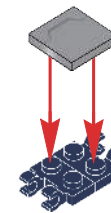

236

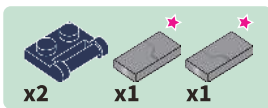
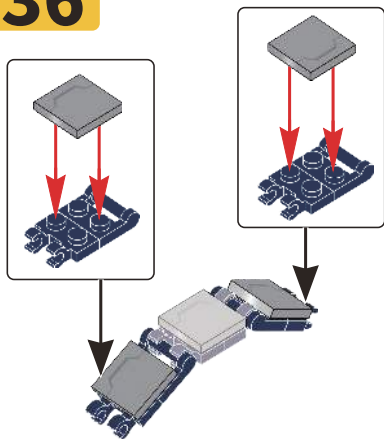

237

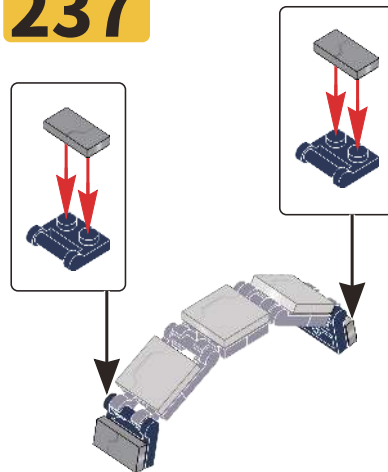

238

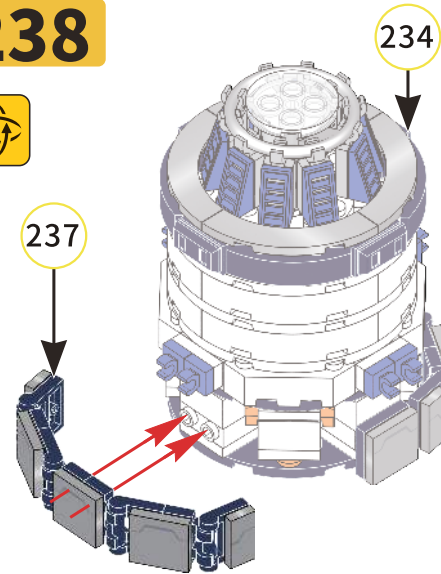

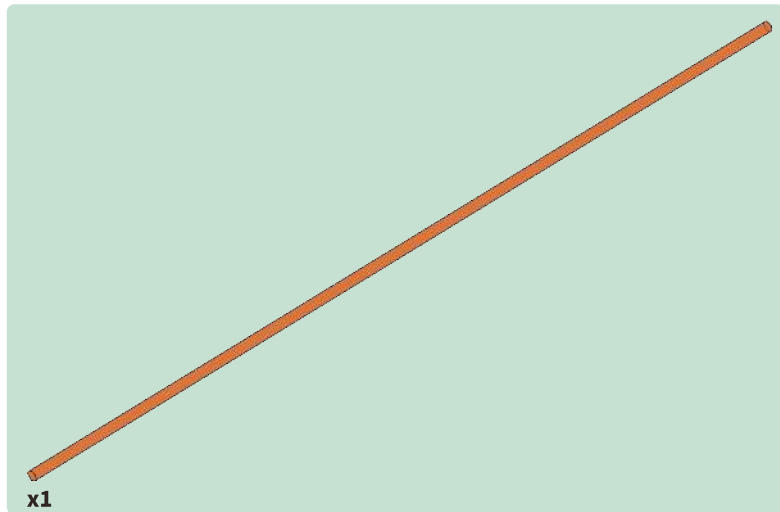

239

将软管按箭头指示在卡点固定环绕一圈
Fix the hose at the connecting points around
this part as indicated by the arrow

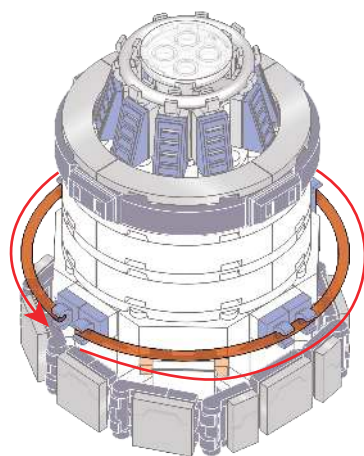

240

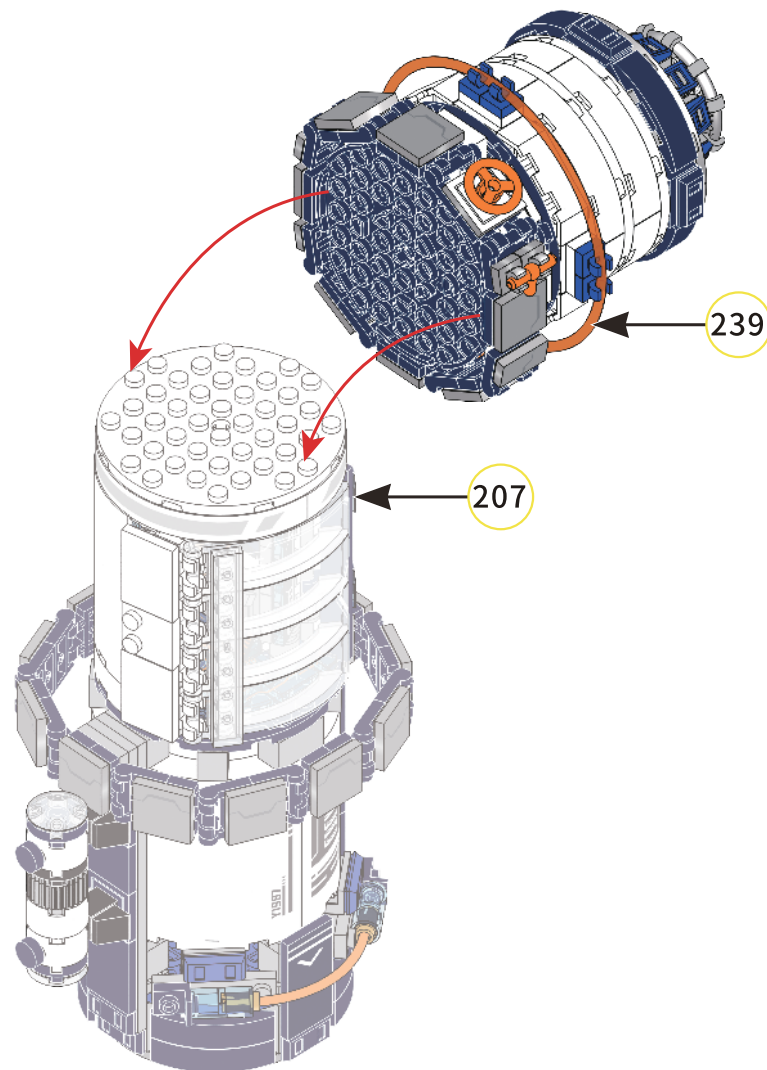

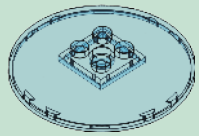

x1



x1



x1



x1



x1

241

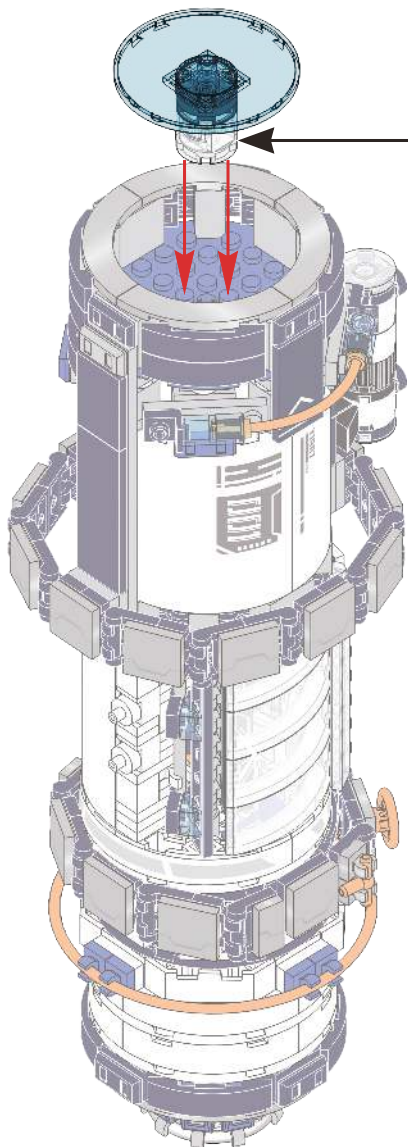

1



扭动可发光
This part will give out light when you twist it



2

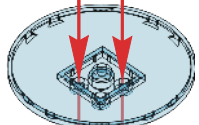

242

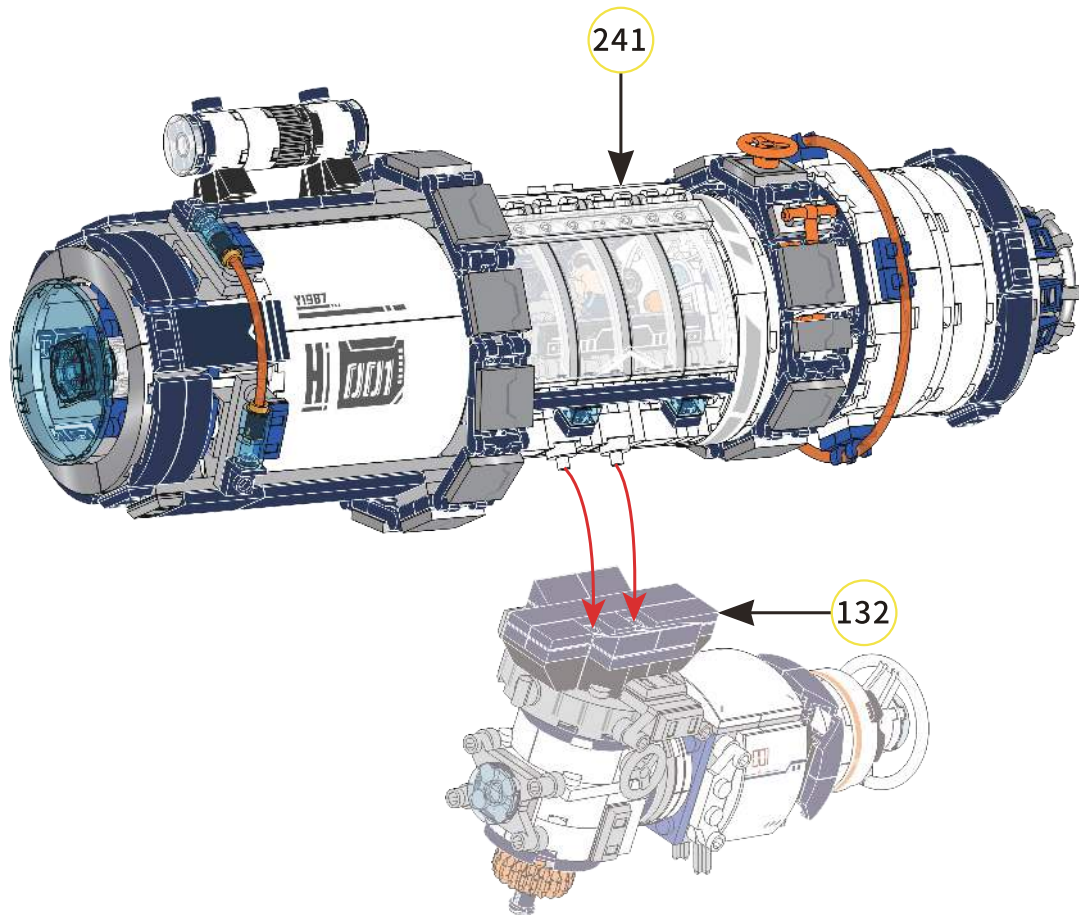

243

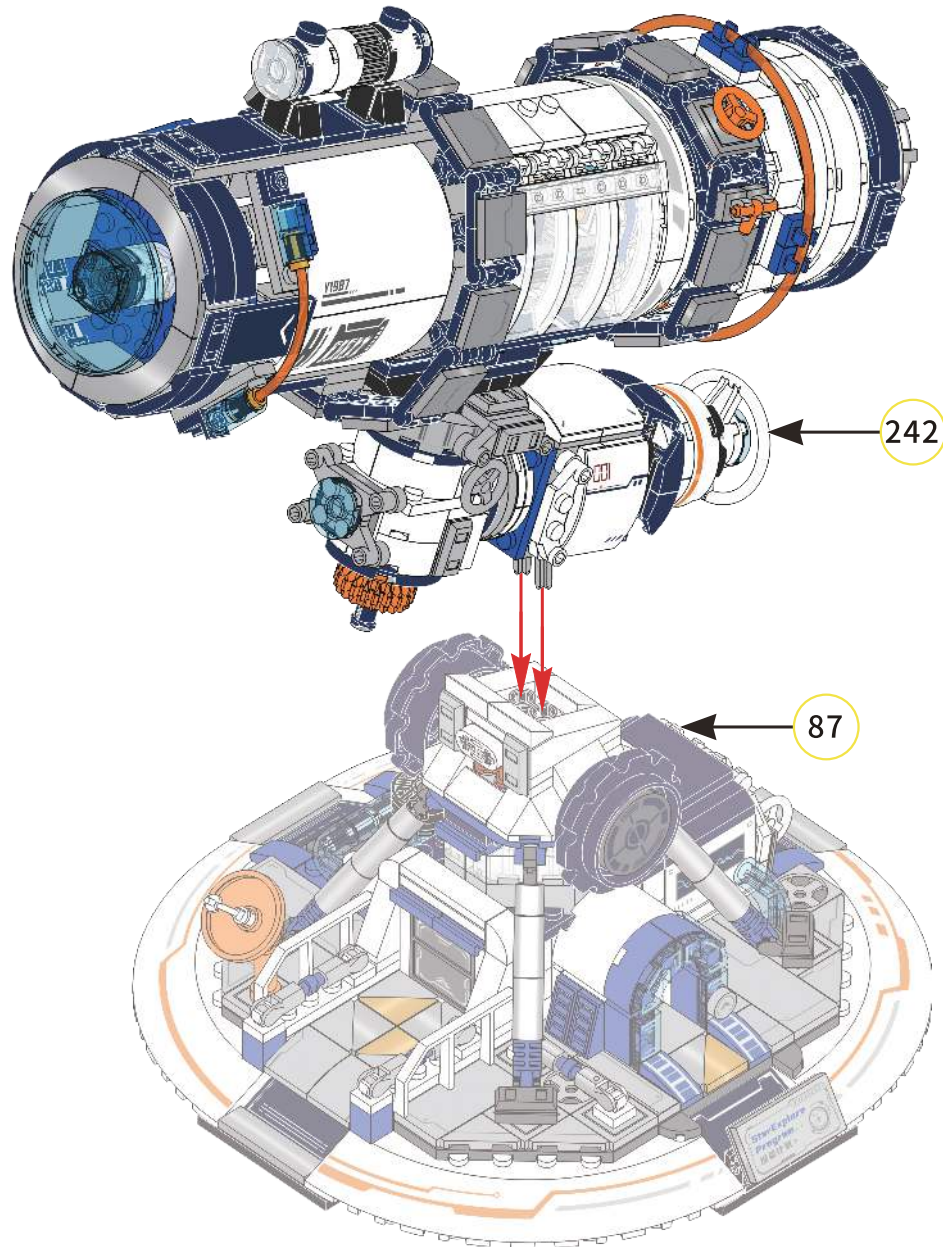

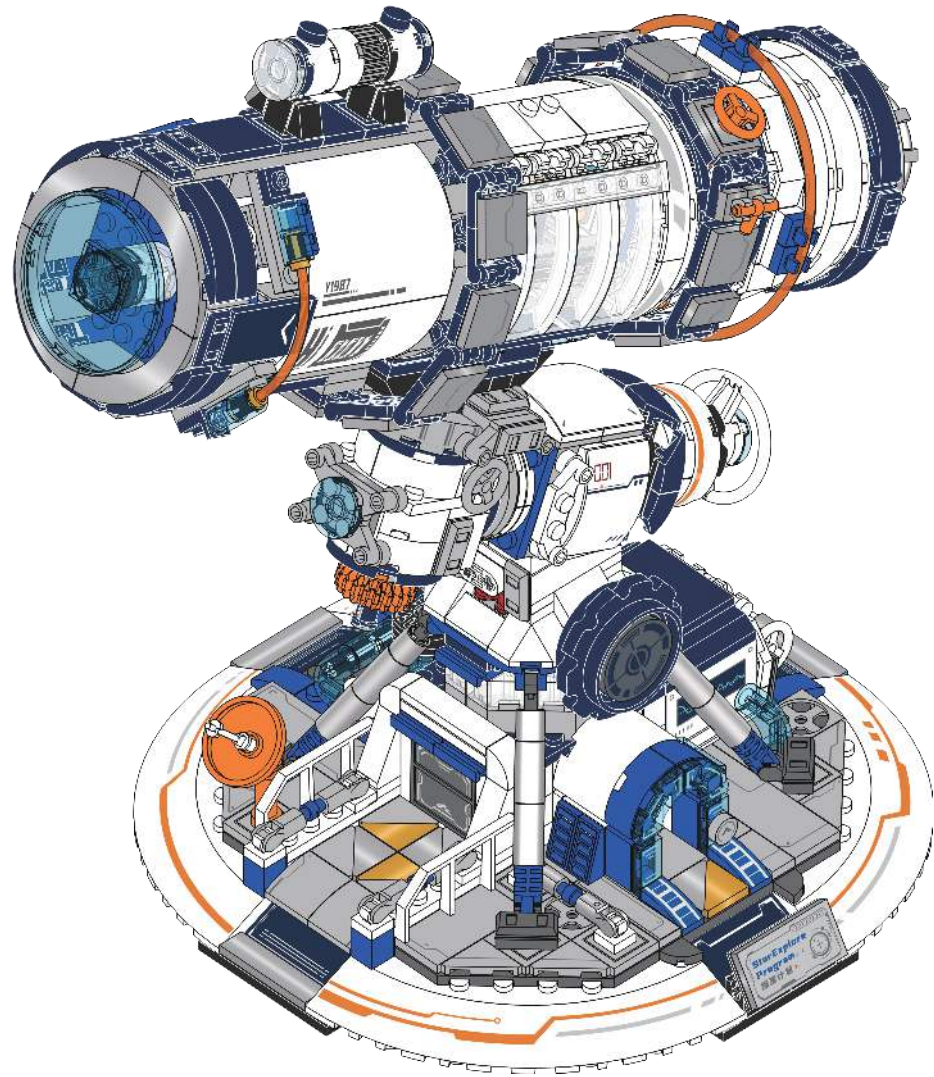

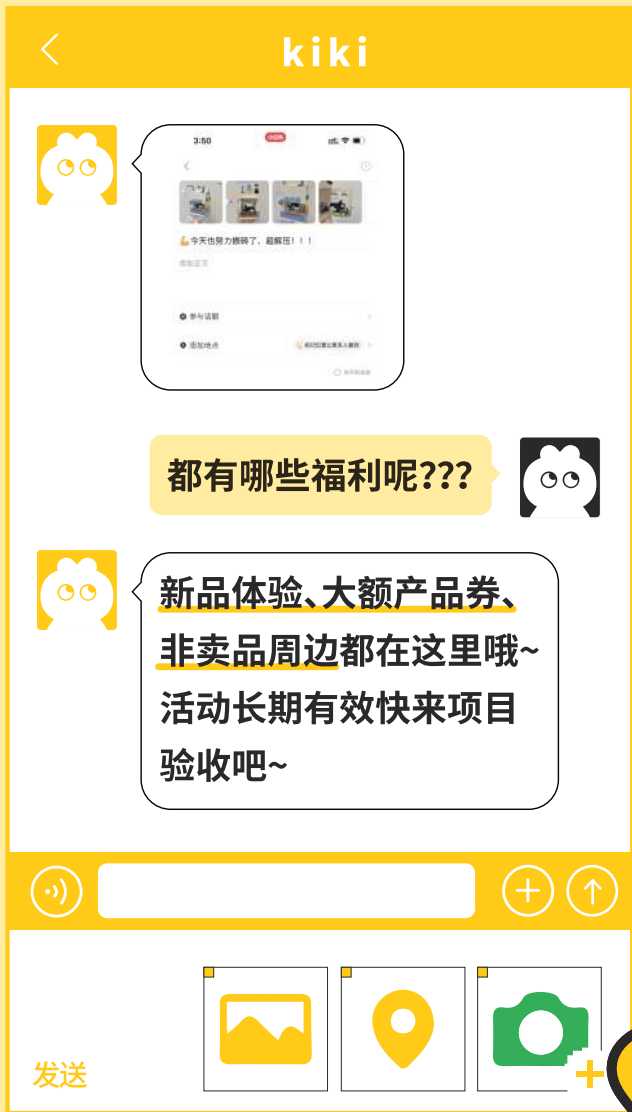
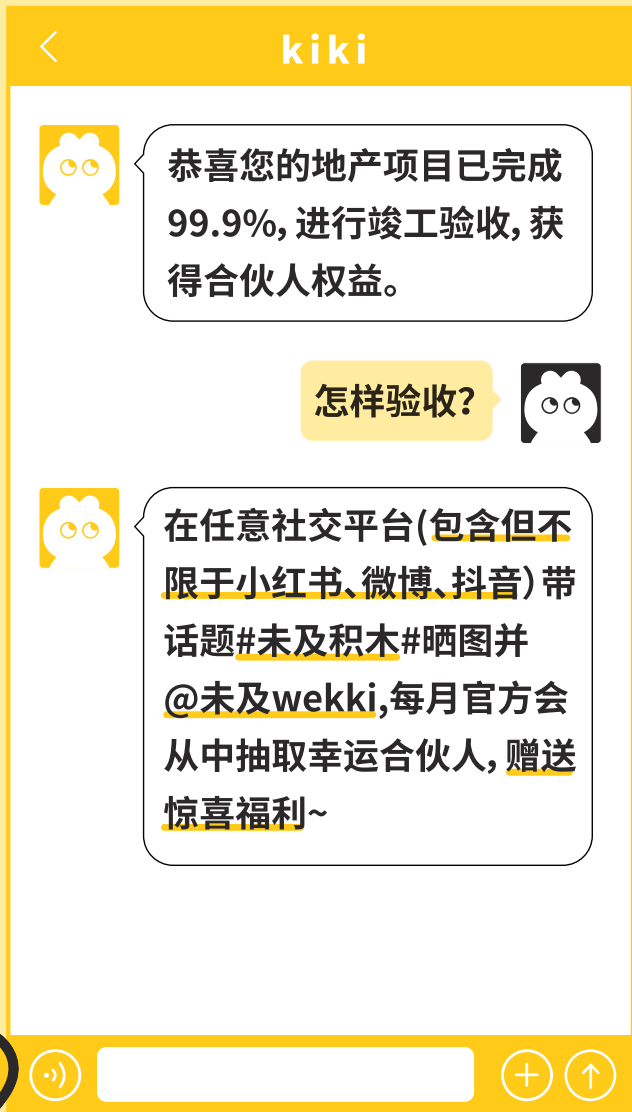

partner

合伙人 _____

Completion time

竣工时间 _____

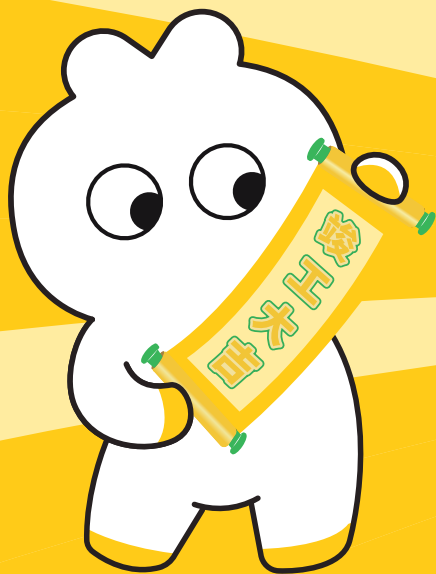

科技馆



Click

解锁更多...

6+
适玩年龄

探星计划!



砖块走失了?

赶紧上未及Wekki公众号登记寻砖启事

The bricks are missing...