

# Mythic Dragon Tiles

| 70020 | 1532+Pcs



JMBricklayer



*Brick It Happen*

**WARNING:** CHOKING HAZARD.  
Toy contains small parts and a small ball.  
Not for children under 3 years.

**14+**  
**AGES**



Embrace Relaxation  
Embrace Joy



Every adultescent needs a "JOY BOX".  
Please, open your JOY BOX!



Heading for joy.  
Welcome to the Unzip Club.



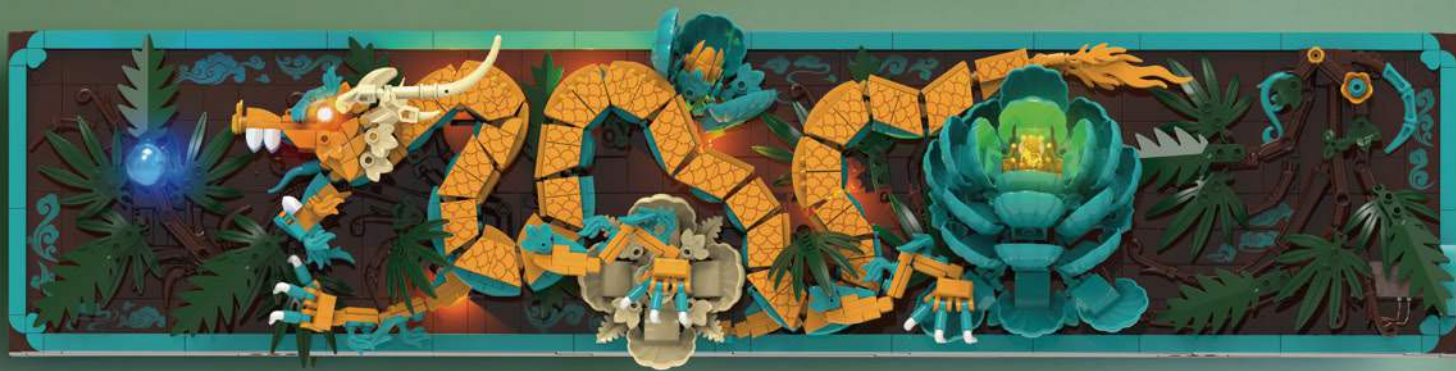



Contact us can visit [www.jmbricklayer.com](http://www.jmbricklayer.com) email [Service@jmbricklayer.com](mailto:Service@jmbricklayer.com) or via our app **JMBricklayer**

Welcome each and every one who came to discuss business cooperation via email [Business@jmbricklayer.com](mailto:Business@jmbricklayer.com).

You can find us on Facebook and Twitter to get latest products information and activities. Search **JMBricklayer** on Facebook and Twitter.

If you find something was missing or broken from your new set. We do our best to make every set perfect and we take it very

seriously when a faulty one sneaks through. Don't worry though, we can send you the parts you need!

Please upload a complete description of the part along with the set number via email: [Service@jmbricklayer.com](mailto:Service@jmbricklayer.com) or our app **JMBricklayer**

Once your part is on its way we'll send you a shipping confirmation email.

## PART ASSEMBLY ORDER



The color of the bags shown in the image is for reference only (subject to the actual product).

## BRICK COMPARISON UNITS

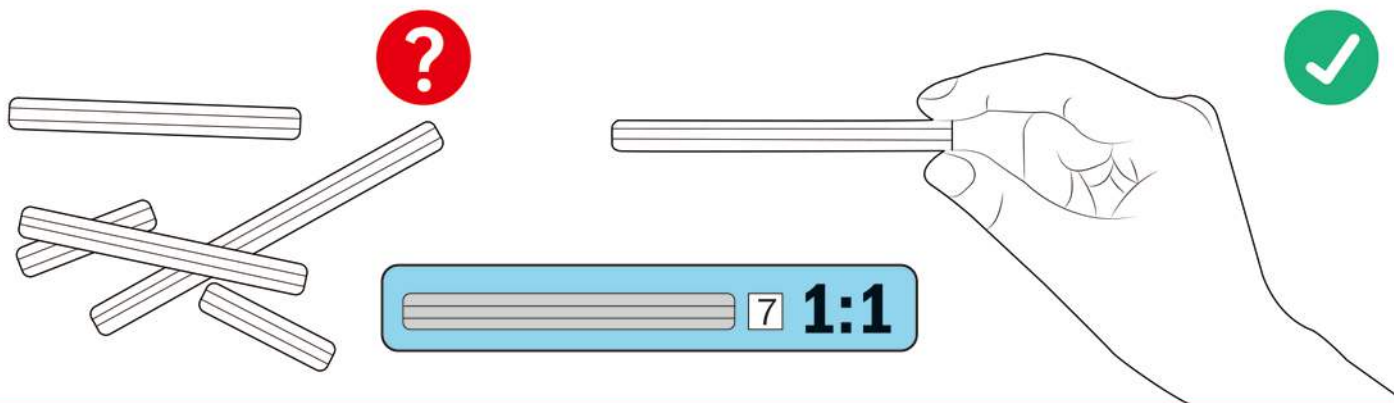

## USAGE OF BRICK SEPARATOR



**JOY MAKES**  
BRILLIANCE.

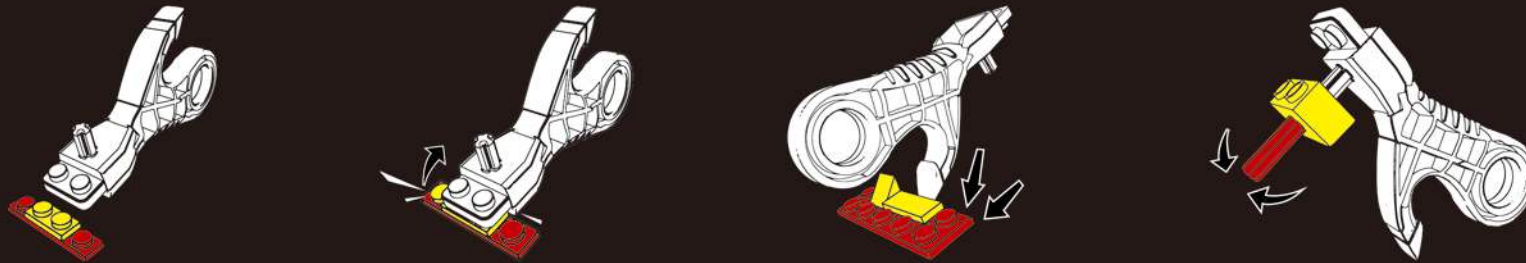

The shape and color of the accessories shown in the image are for reference only (subject to the actual product).

## STICKER INSTRUCTION

01

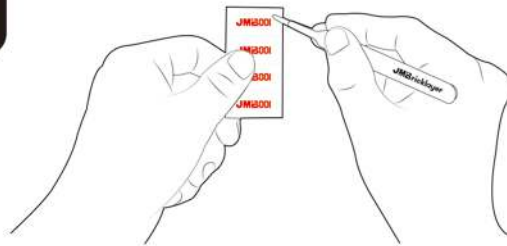

Pick up the transparent edge of the sticker with tweezers.

02

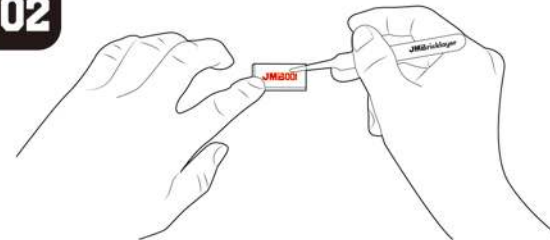

Align the position and stick it to the brick.

03

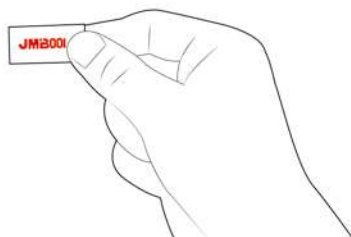

Press the sticker to make them stick tightly together.

04

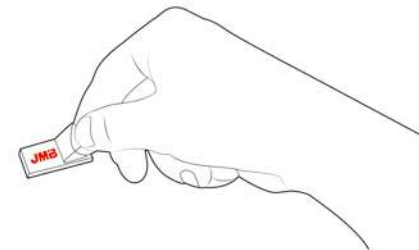

Tear off the transparent film.

**Note:** Some sets come with fully printed brick pieces, in these cases, there are no stickers/decals. Please refer to the actual product for details.



# USER INSTRUCTION



**JOY MAKES**  
BRILLIANCE.

Please read the following carefully before installing the lights.

## CAUTION:

The battery is not replaceable.

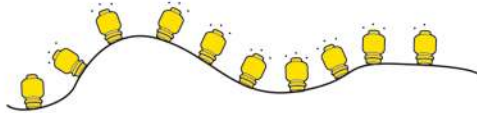

Before installing, please connect to the power supply and test the lights to make sure everything functions properly. If the lights do not work, please refer to the TROUBLESHOOTING or contact us.

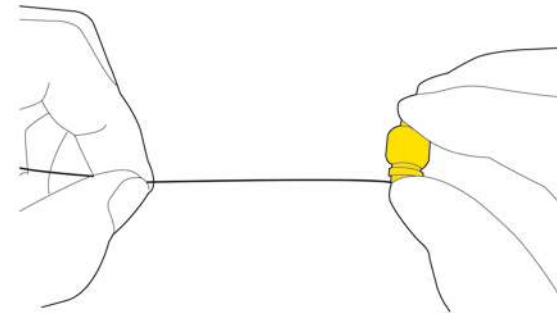

LED components are delicate, so please take extra care when installing, no hard pulling, no bending or shaking.

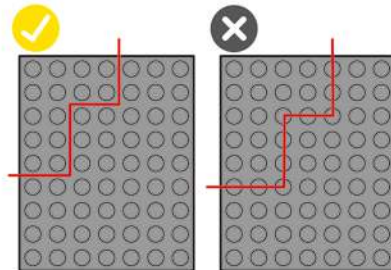

Hide the spare wire under the bricks: when installing, please make sure that the wire is laid between two studs of the bricks, but not pressed by the bricks directly.

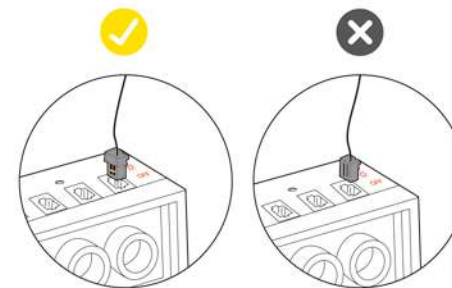

Connectors can be plugged into ports of the expansion board in only one certain way. Make sure its direction is correct before plugging.

Tips: if the connector doesn't fit easily into a port, don't force it.

# USER INSTRUCTION



**JOY MAKES BRILLIANCE.**

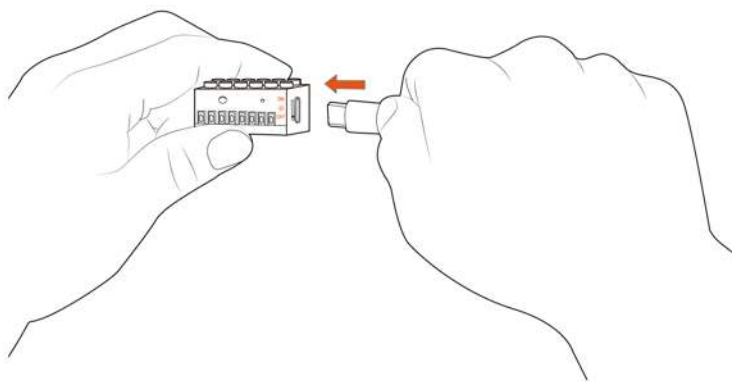

When connecting to power, the input voltage must be less than 5V, otherwise, it may damage the components of the battery brick.

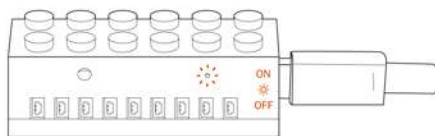

During charging, the indicator light will stay on with a red light. Once fully charged, the red light will turn off.

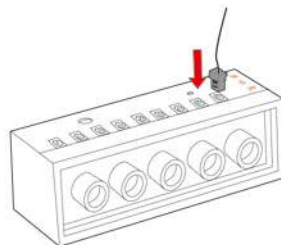

Connectors can be plugged into ports on the battery brick in only one certain way. Make sure its direction is correct before plugging.

Tips: if the connector doesn't fit easily into a port don't force it

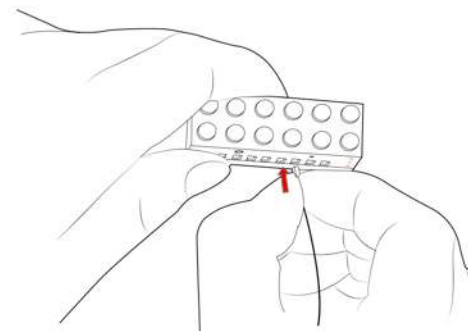

When plugging and unplugging the wire connectors, gently pull on the white connector with your fingers. Be sure not to pull the light wire with force, as this could break the wire.

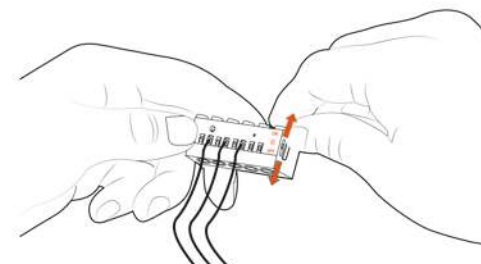

These three modes meet versatile usage scenarios, catering to different needs, whether constant illumination, energy-saving automation, or complete shutdown.

**Note:** When in use, the voltage must be less than 5V. Not for children under eight.

## LIGHTING FUNCTION DISPLAY

**ON**

In this mode, the lights remain continuously illuminated once turned on, providing steady illumination until manually switched off.



This mode activates the light only when ambient lighting is low, automatically turning on during nighttime or in dark conditions and switching off in bright environments, effectively saving power.

**OFF**

Selecting this mode completely turns off the device, ensuring no power consumption occurs until the user manually activates it.

**BATTERY BOX NAME:** Integrated Battery Brick

**RATED CAPACITY:** 150mAh

**BATTERY RATED VOITAGE:** 3.7V

## TROUBLESHOOTING



**JOY MAKES**  
BRILLIANCE.

Due to their small size, lighting accessories are susceptible to damage during installation. Common causes of failure include:

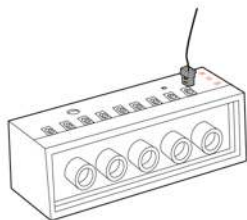

Ensure that the connectors are correctly installed as shown in the picture.



Check if the wires are disconnected or broken from the solder joints.

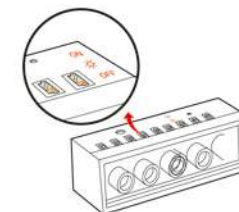

Check the internal pins of the ports on the battery brick. The internal pins of a properly working port should be straight, if the small pins are bent, they may be considered faulty ports.

If you have checked each string of lights according to the guide above and the lights are still not working, please contact our customer service for assistance.

## SAFETY PRECAUTIONS

- 1 Before use, verify the voltage to avoid damage to the product and potential safety hazards. The light set must only be powered by a 5V DC (or lower) power supply. Otherwise, the resistors may overheat and burn out, shortening the lifespan of the LED beads.
- 2 The lights in the product are not replaceable. If they are damaged or not lighting up, please refer to the troubleshooting section or contact our customer service for assistance.
- 3 Avoid pulling on the lighting wires as this may cause damage.
- 4 Do not expose the product to water as it may damage the product.
- 5 If the plug does not fit easily into the ports on the board, reverse the direction and insert it again to avoid damage and short circuits, rather than forcing it in.
- 6 Please read and follow the instructions carefully during building to ensure a good building experience.

# COLOR COMPARISON



**JOY MAKES**  
BRILLIANCE.

The color used in this manual is slightly different from the actual color of the parts. The white background photo in the legend below is the actual part, you can refer to the following diagram to identify the parts.

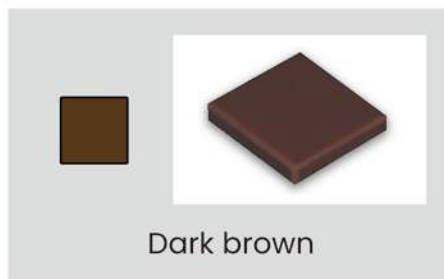
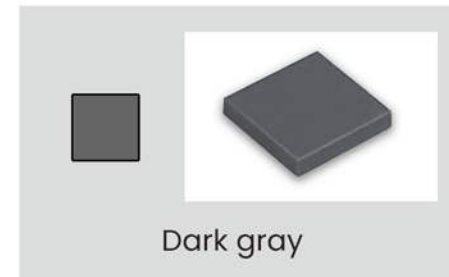
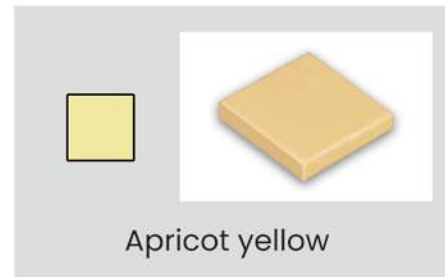
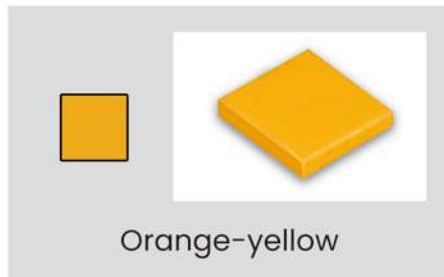
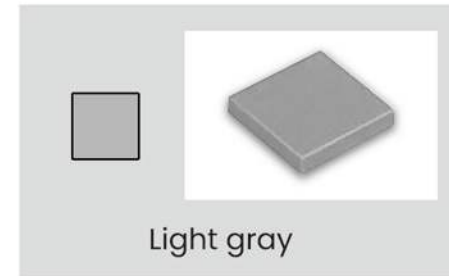
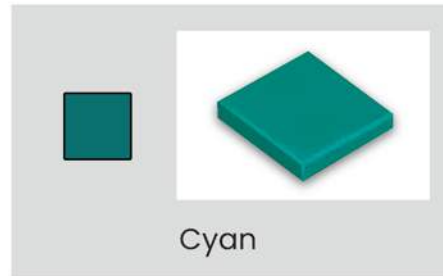
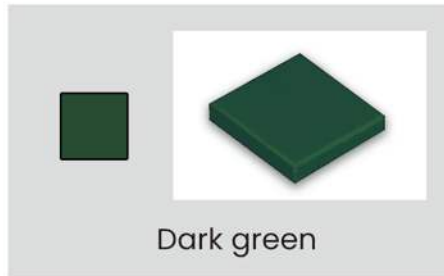

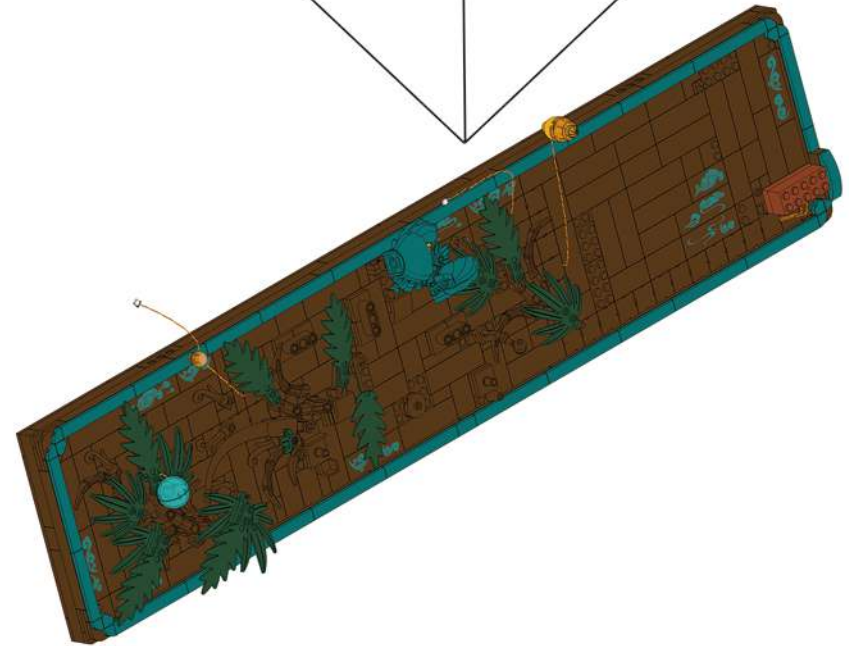
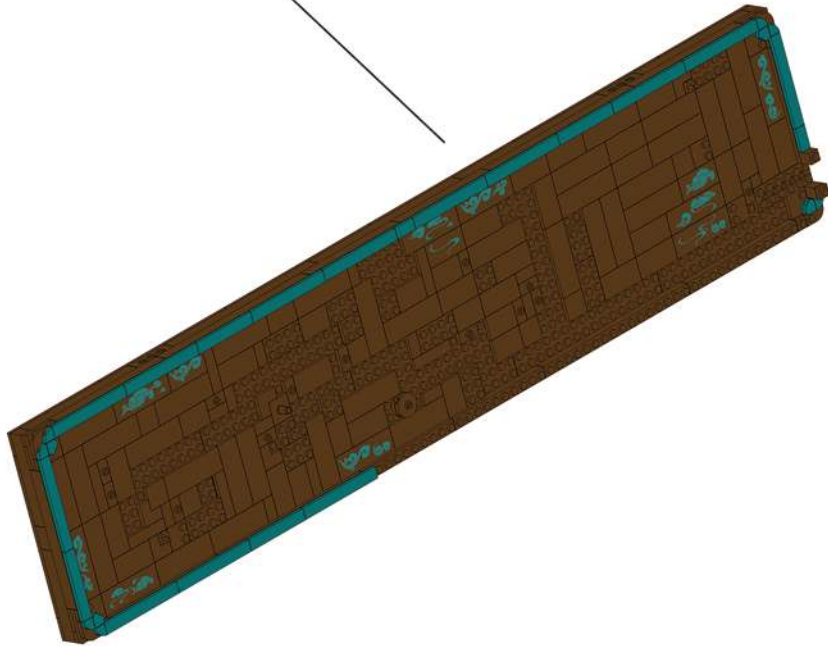

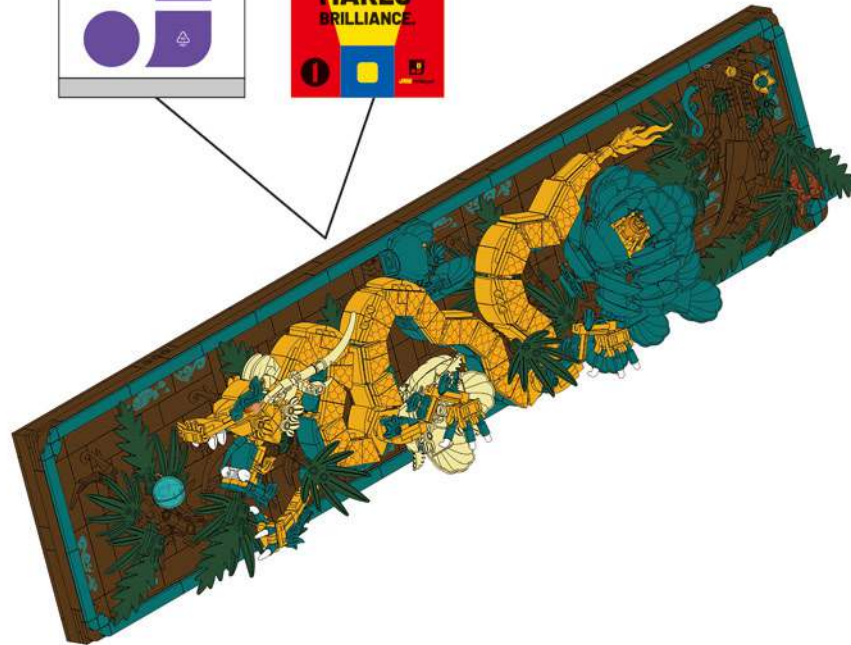
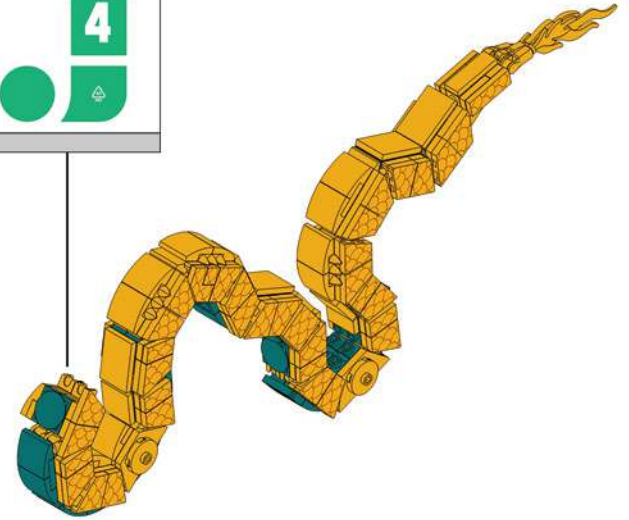
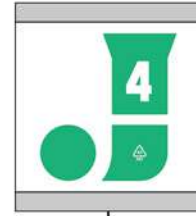

# JOY MAKES BRILLIANCE.

## Embrace Relaxation Embrace Joy

Every adultescent needs a "JOY BOX".  
Please, open your JOY BOX! Heading for joy.

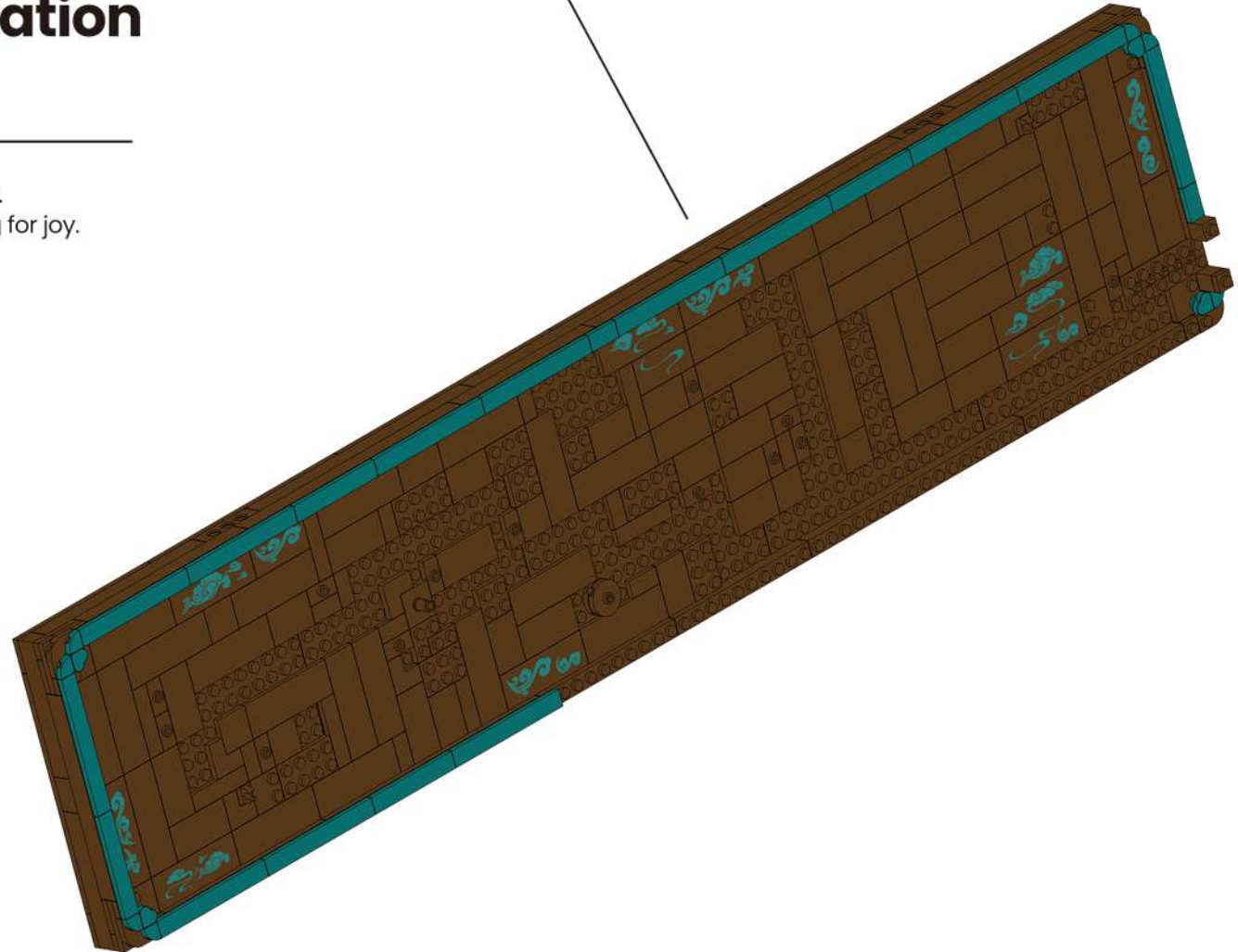

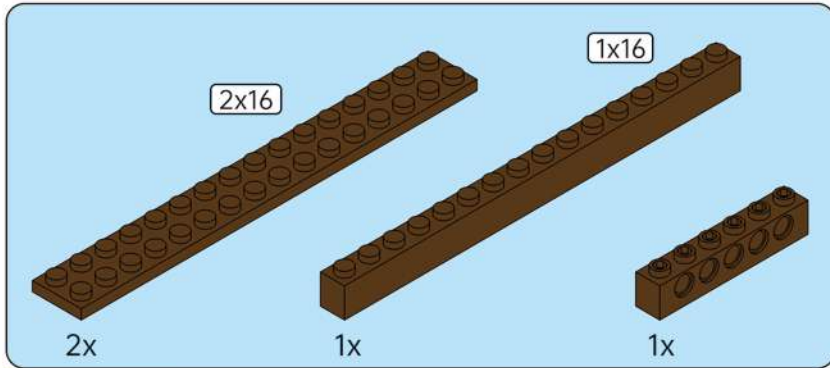

01

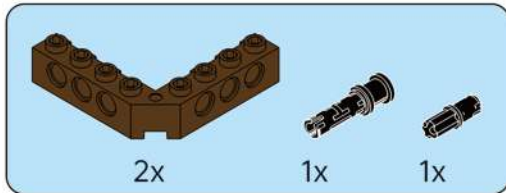
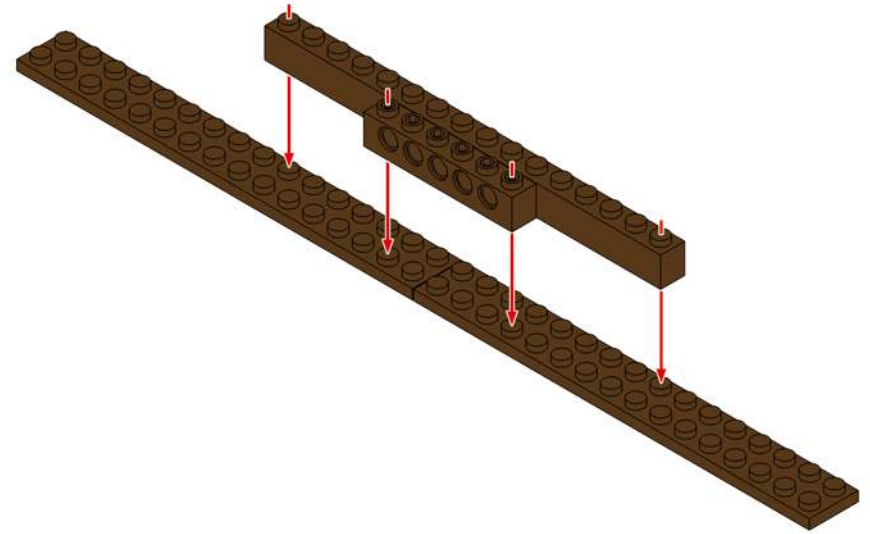

02

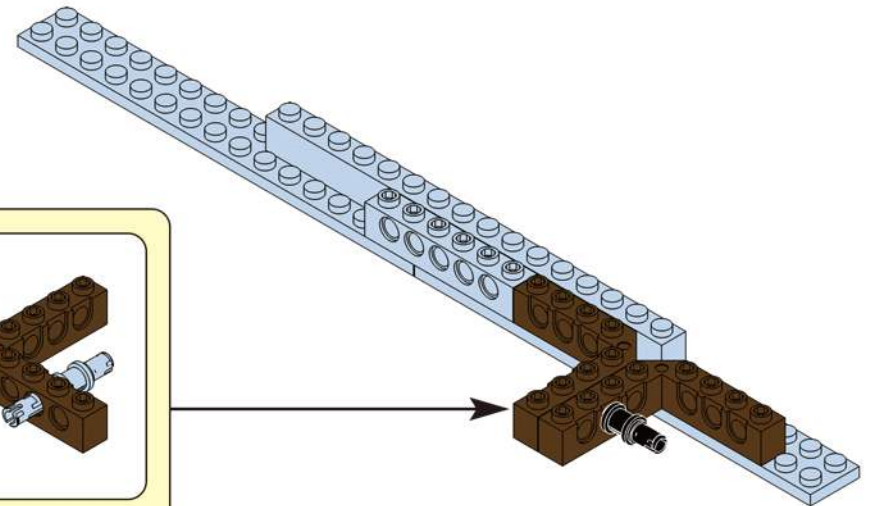
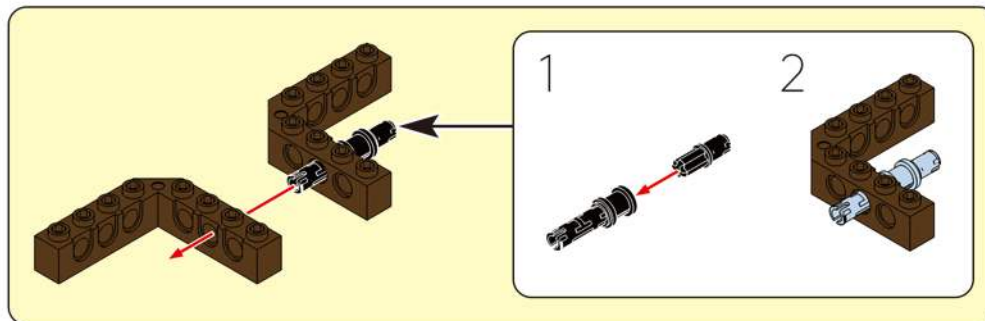

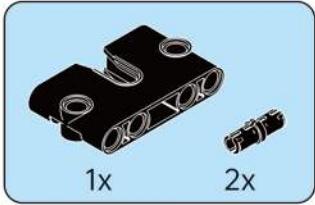

03

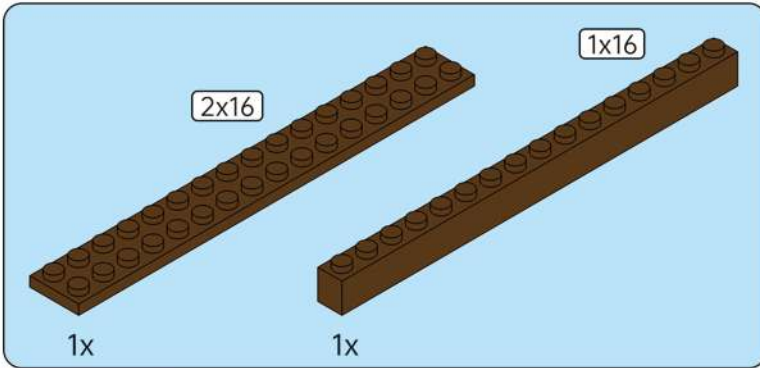
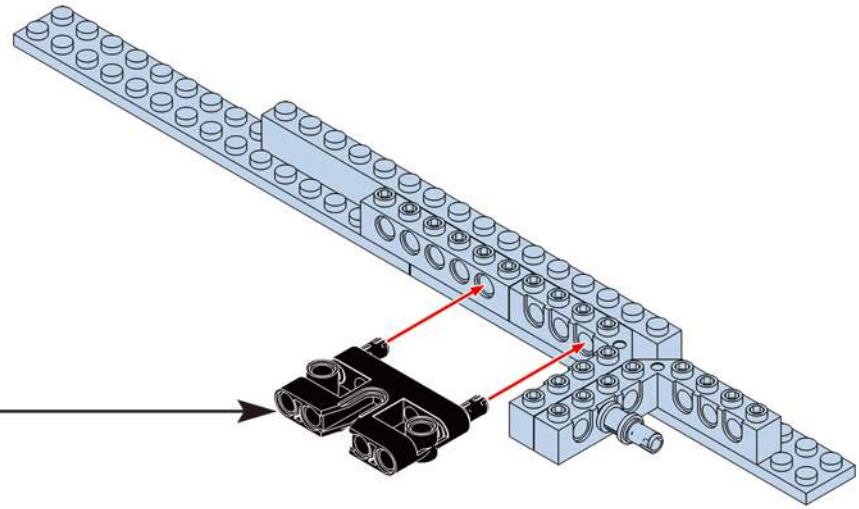
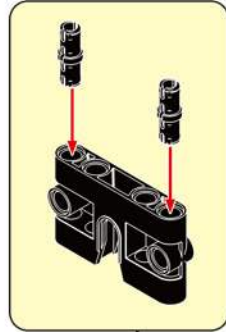

04

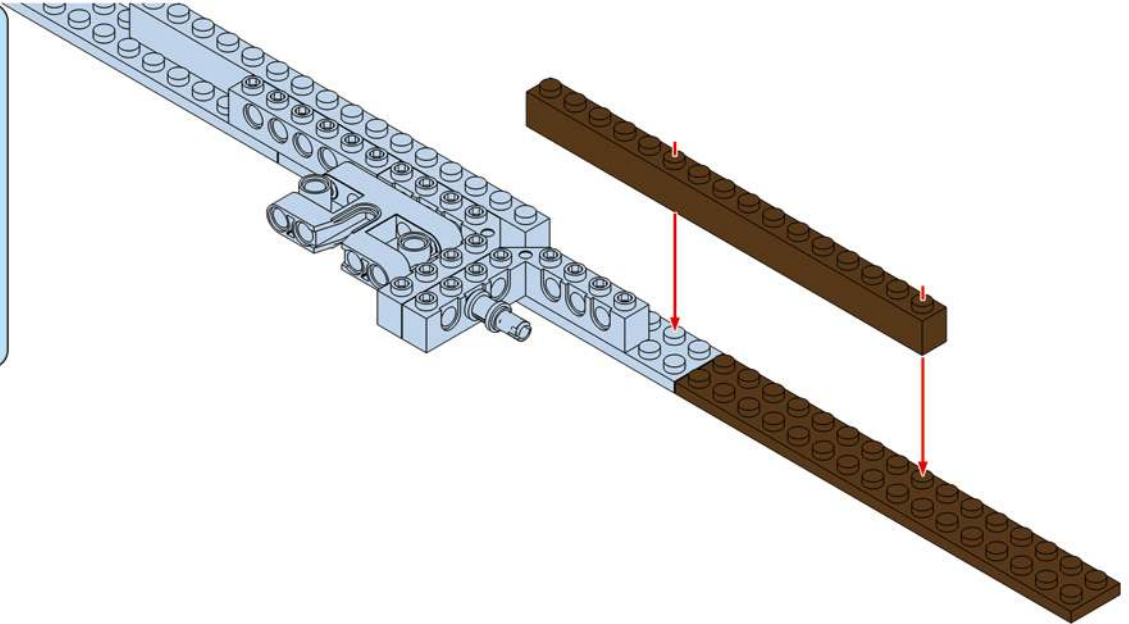

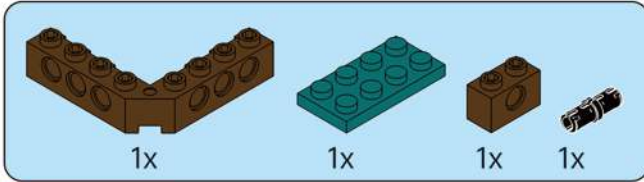

05

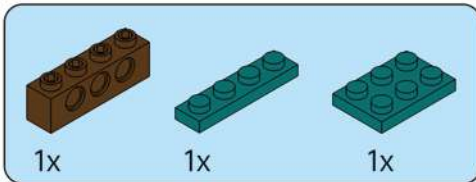
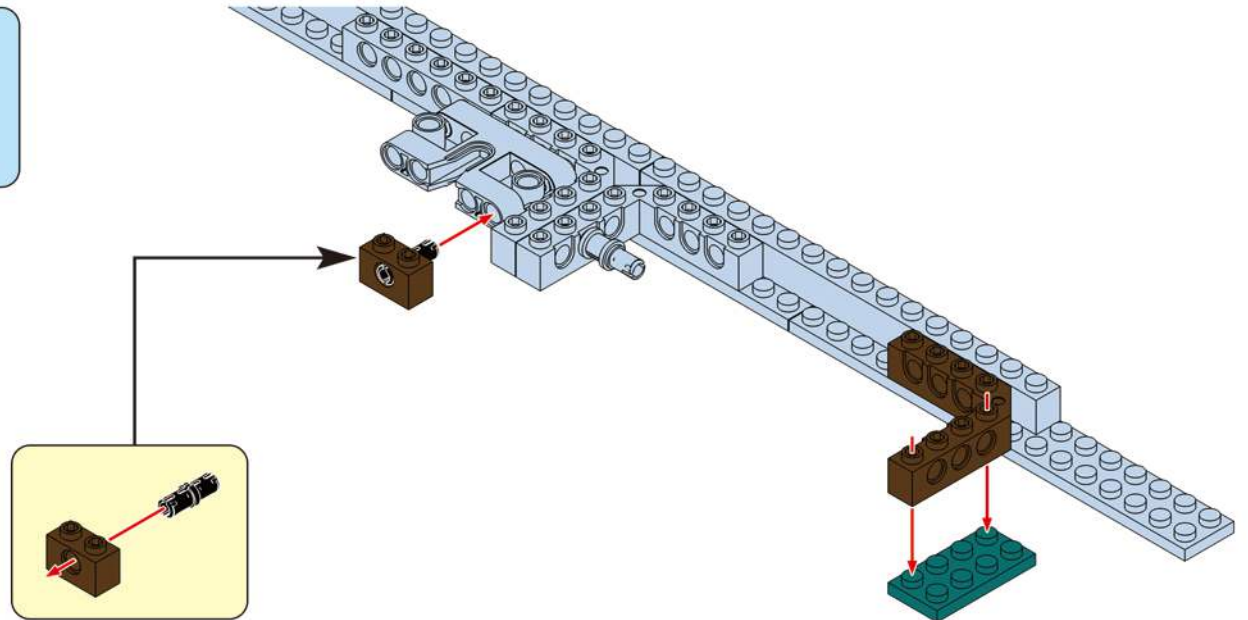

06

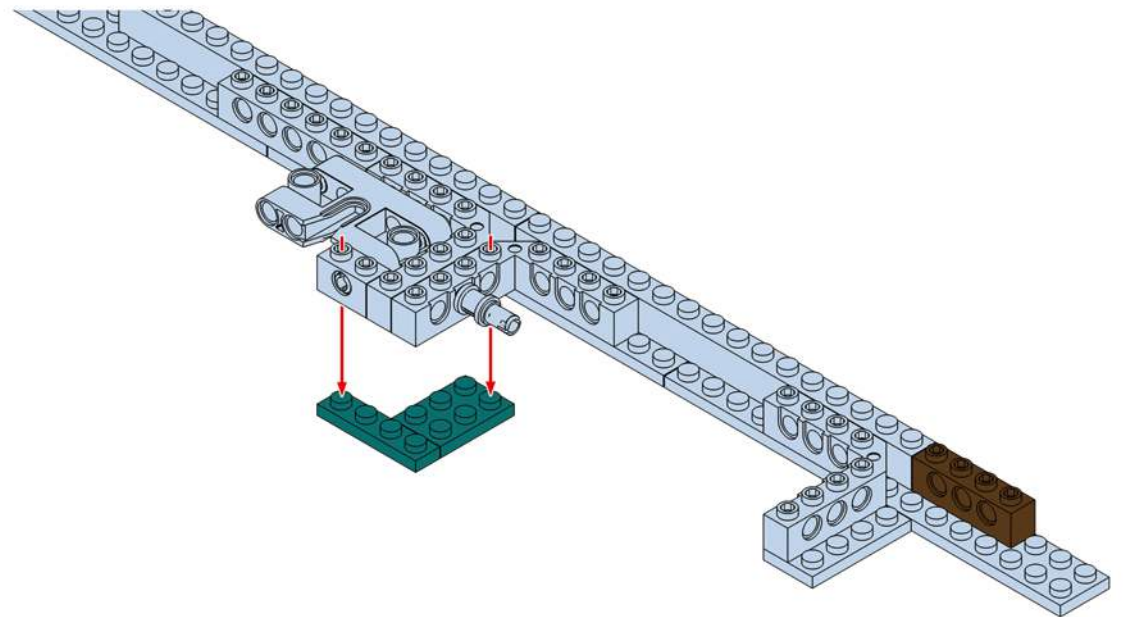

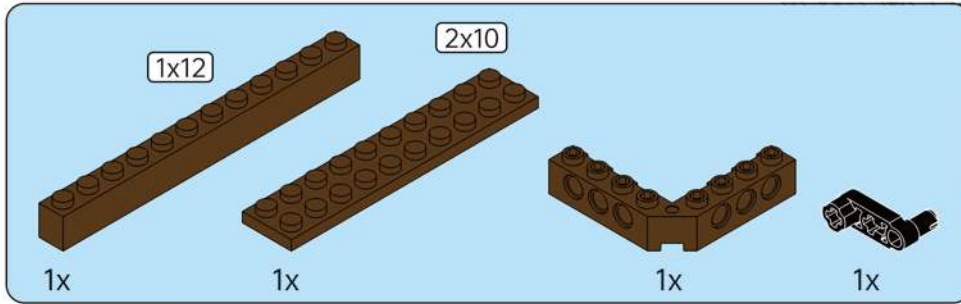

07

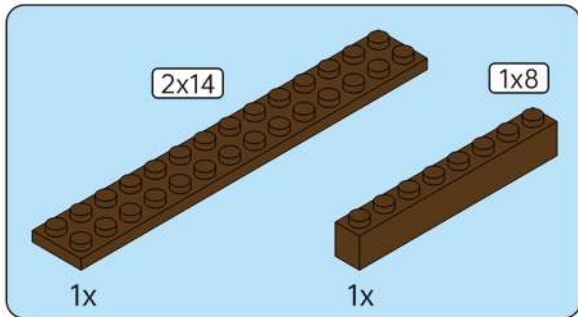
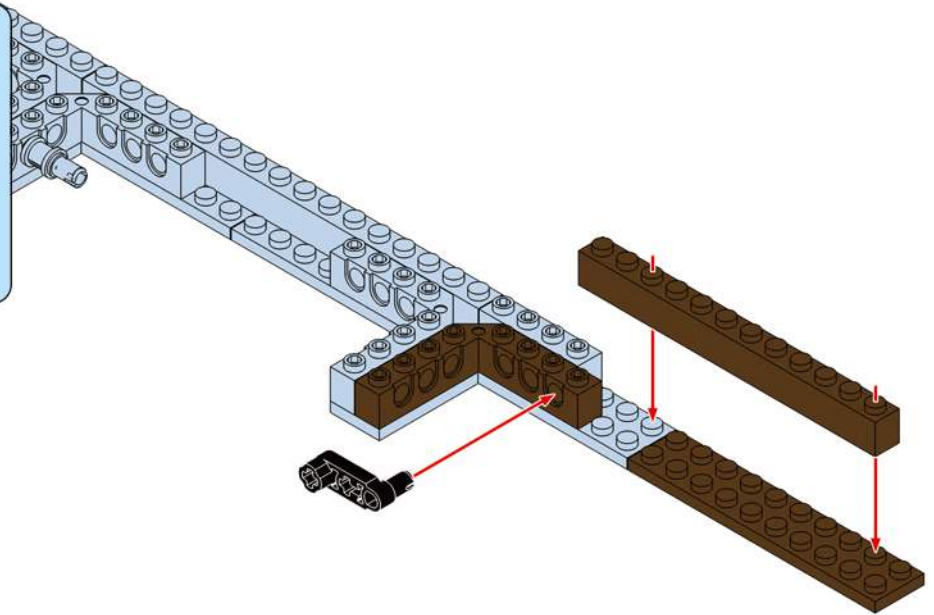

08

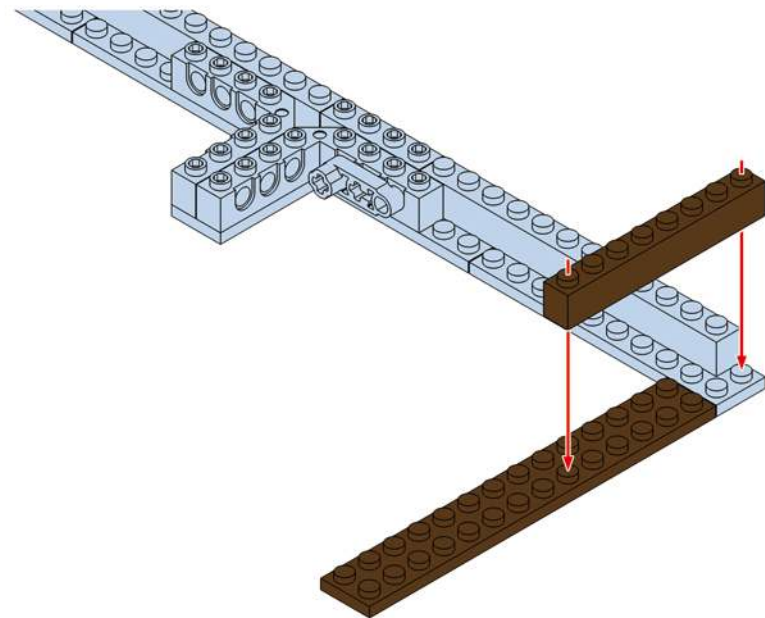

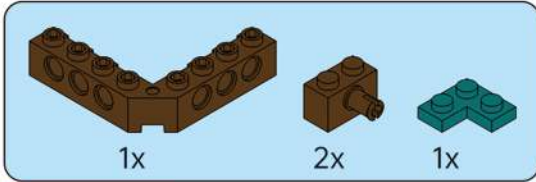

09

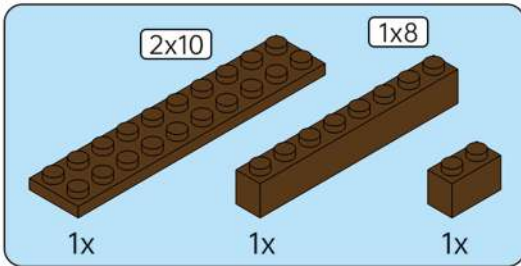
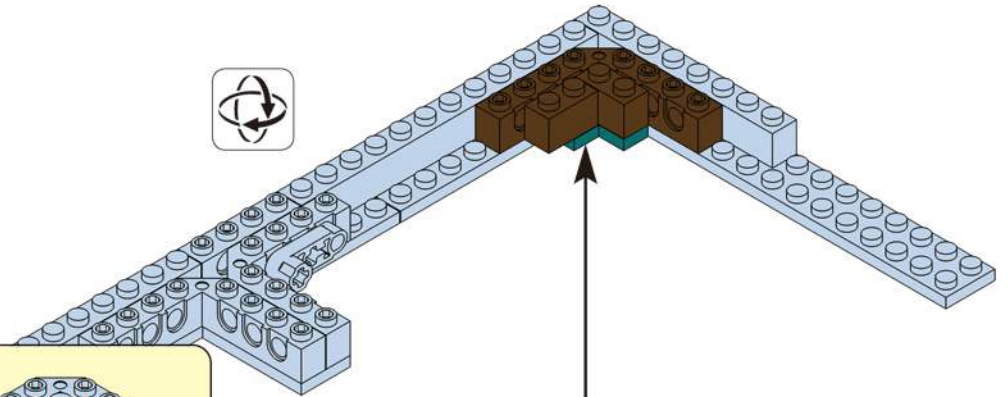
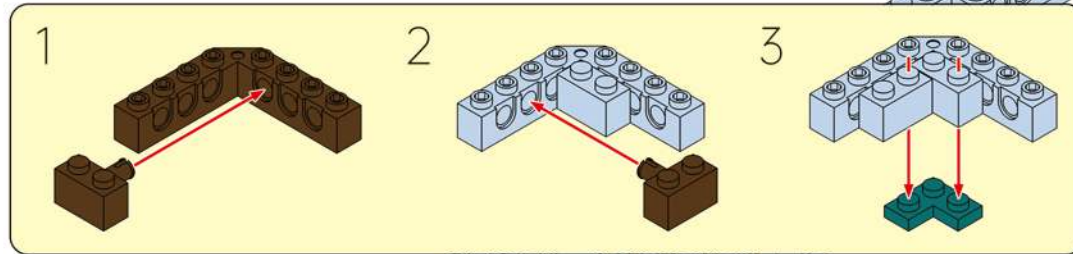

10

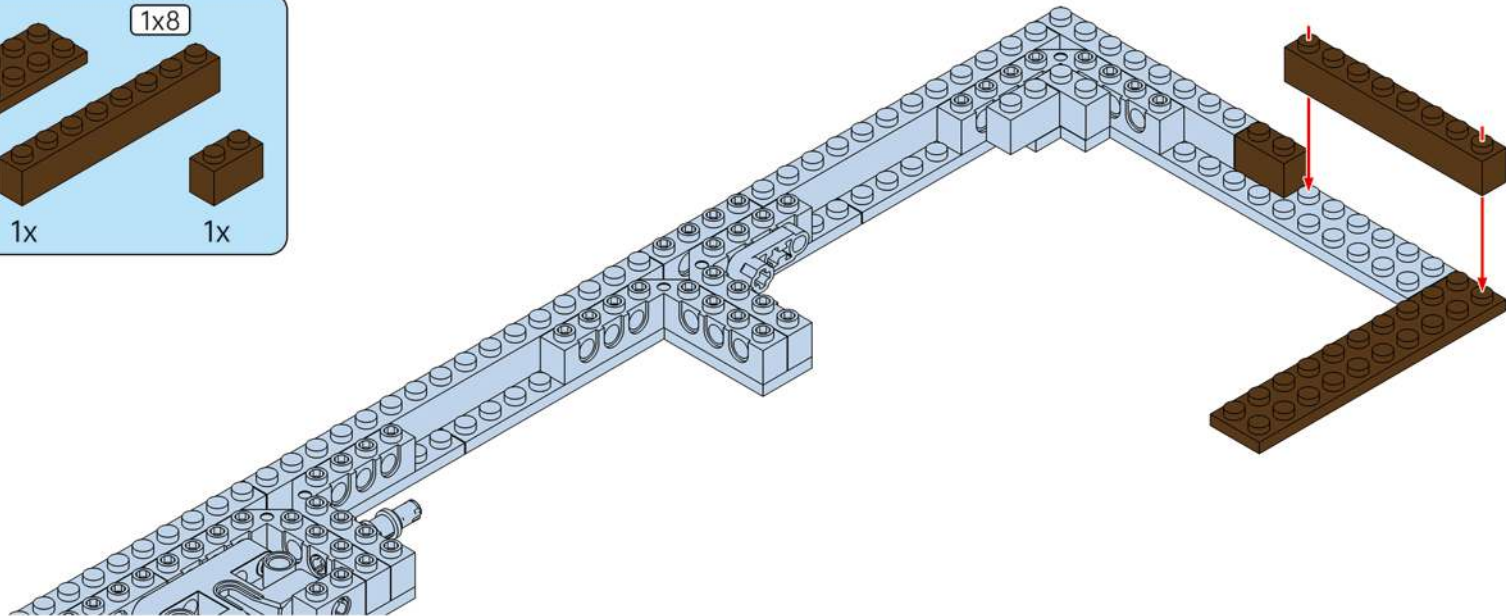

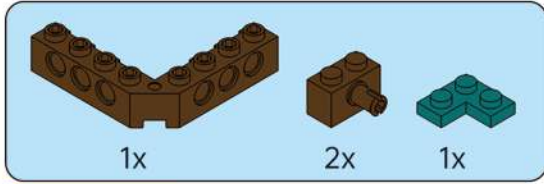

**11**

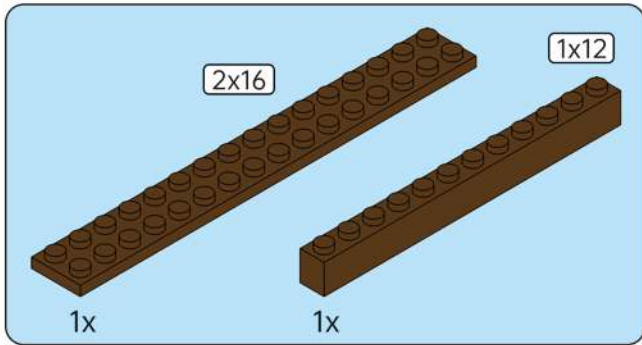
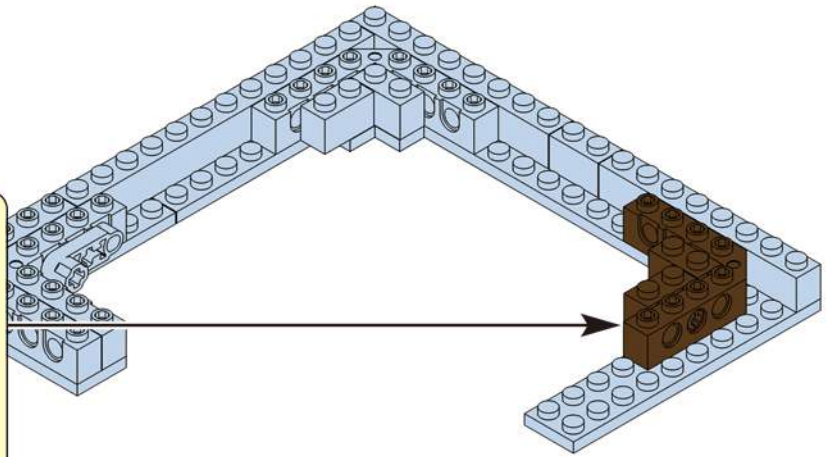
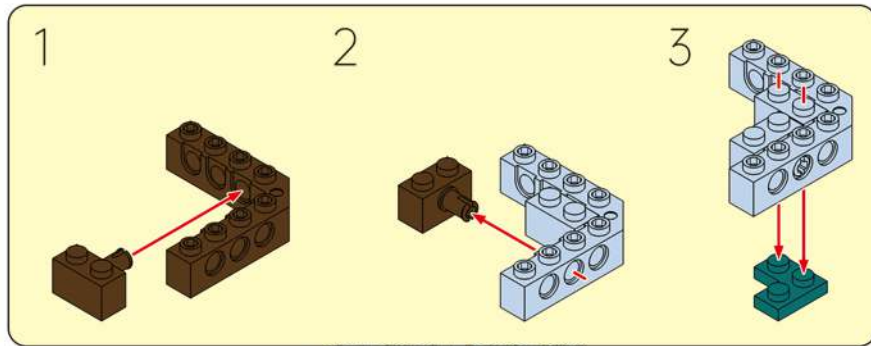

**12**

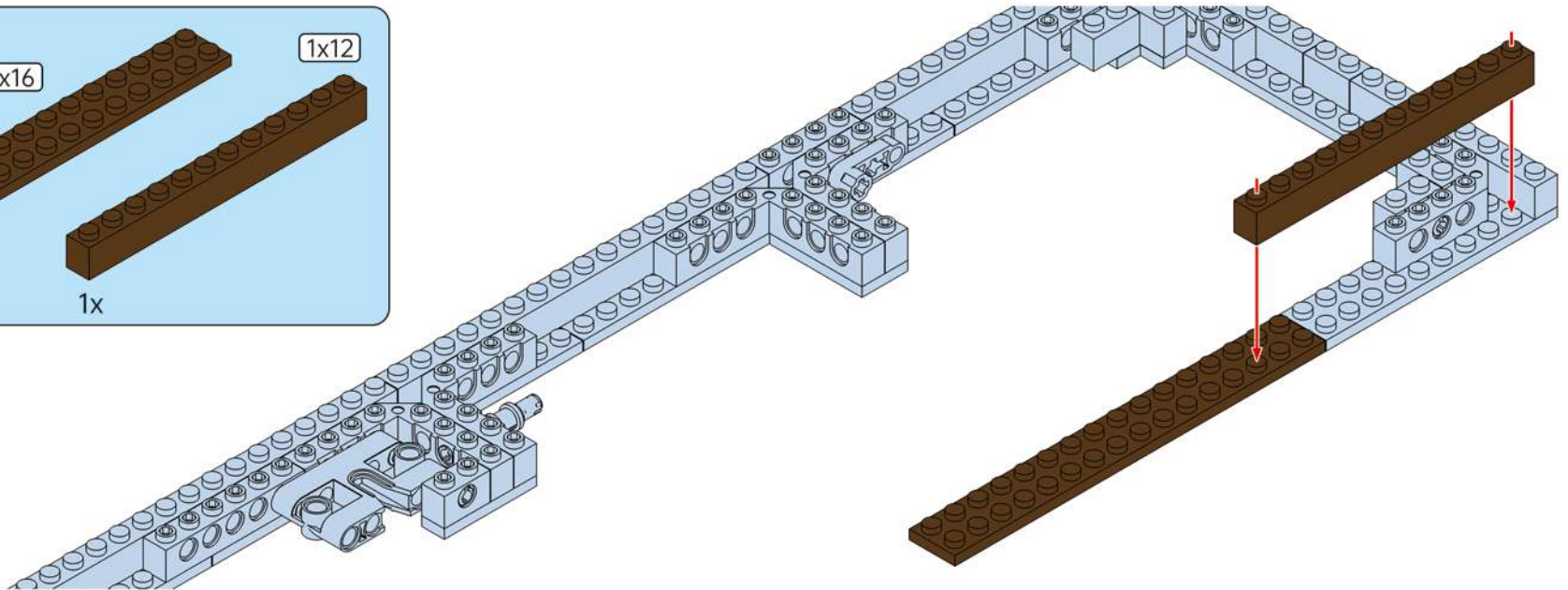

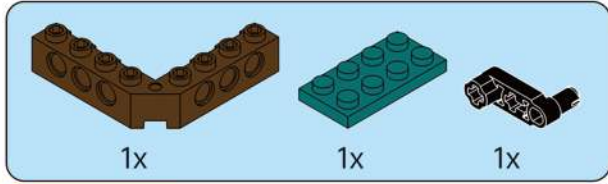

**13**

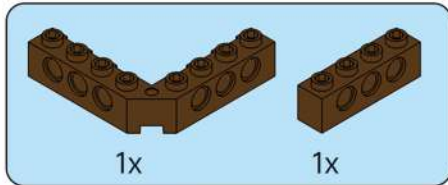
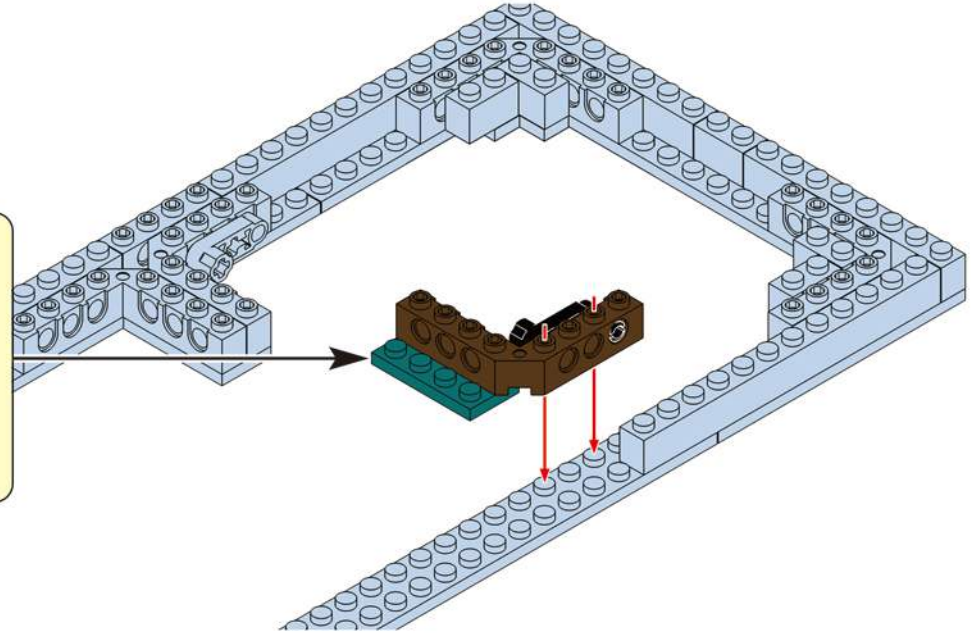
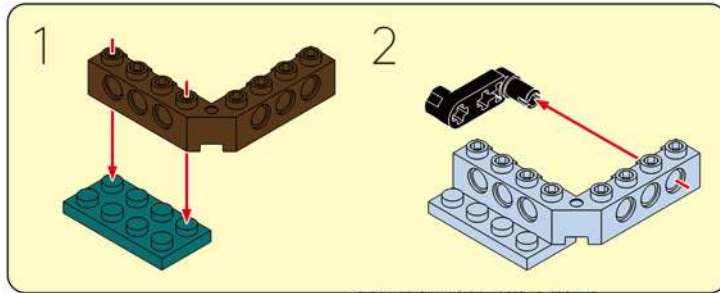

**14**

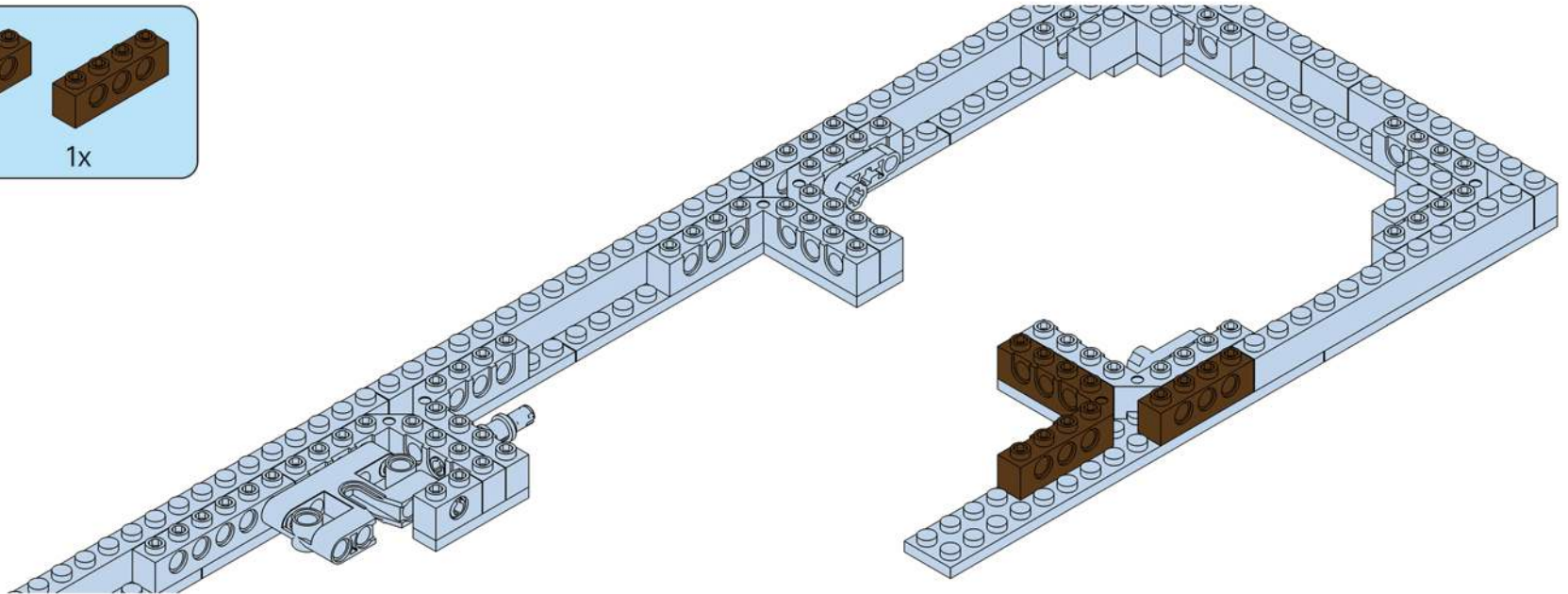

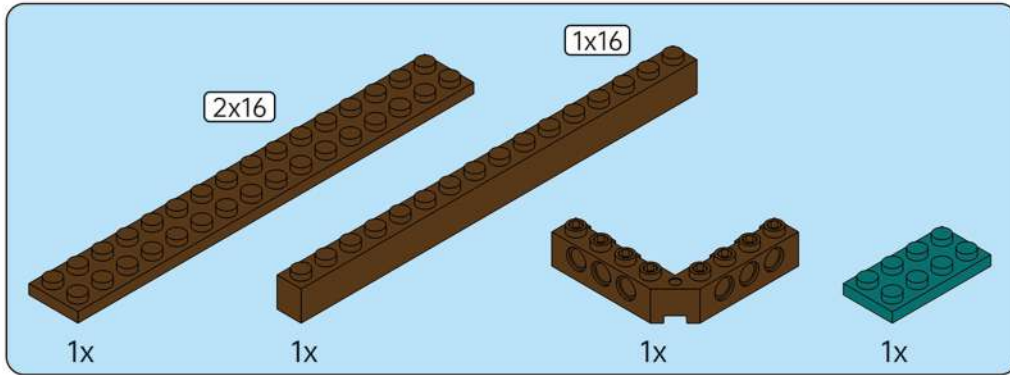

15

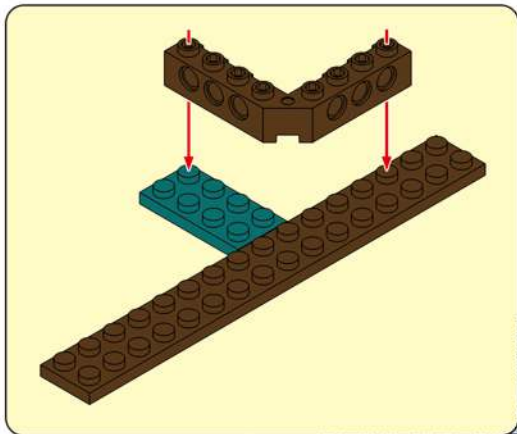
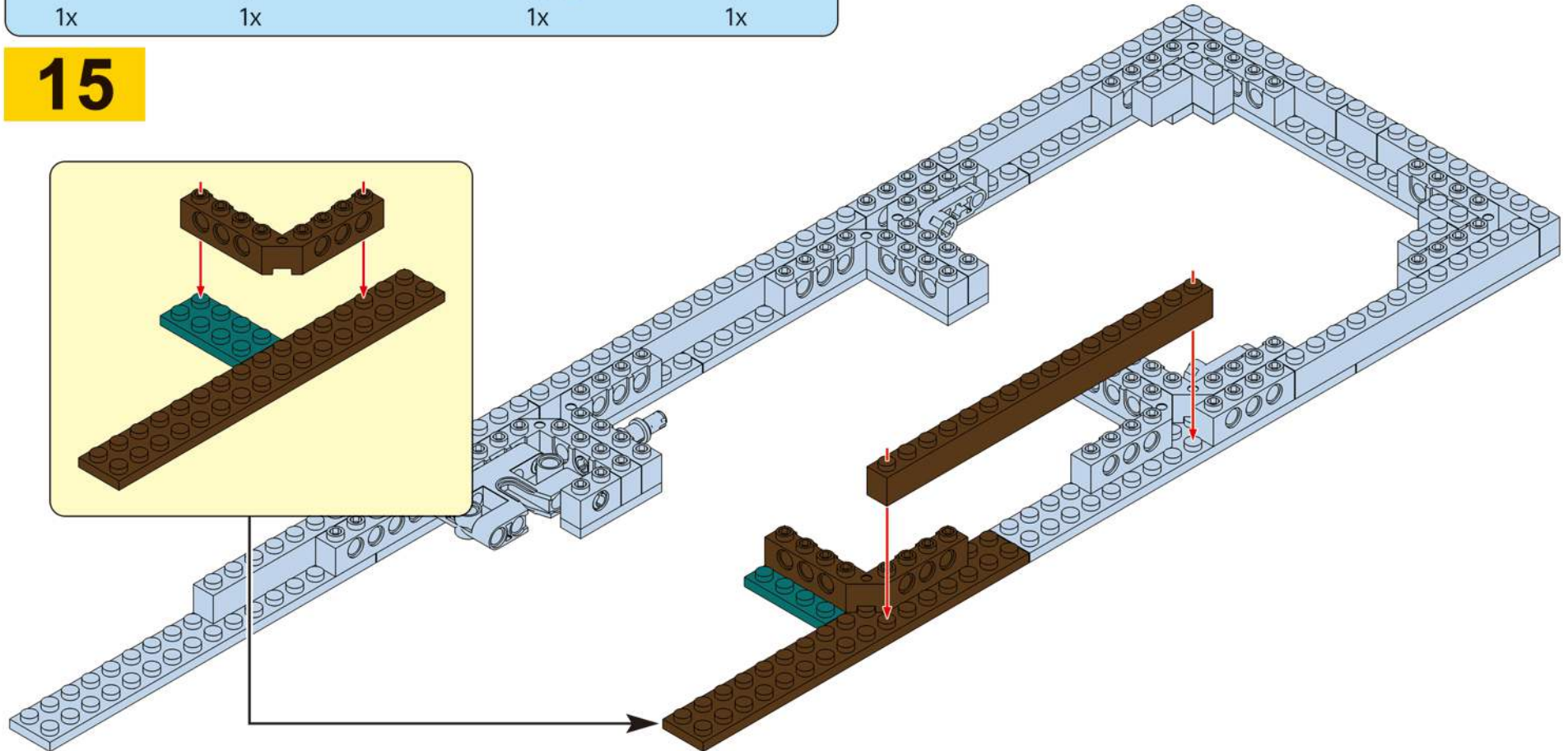

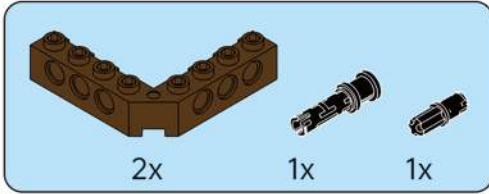

# 16

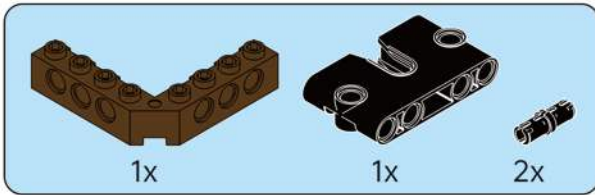
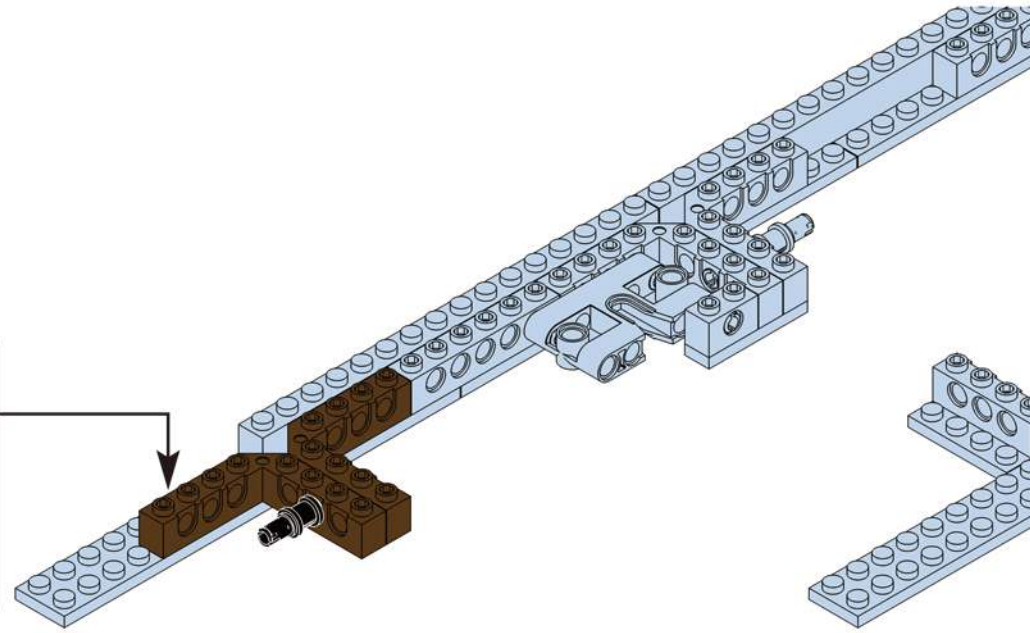
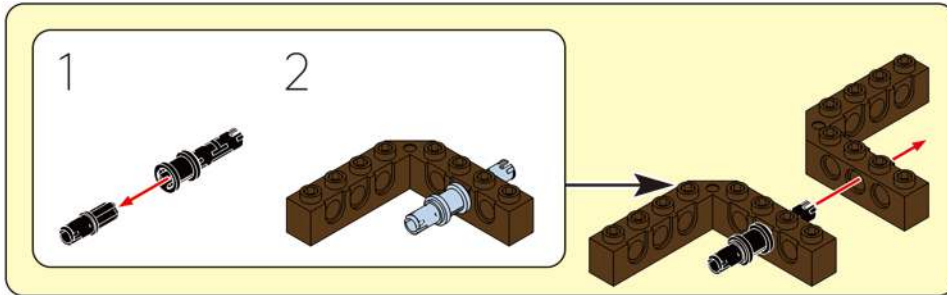

# 17

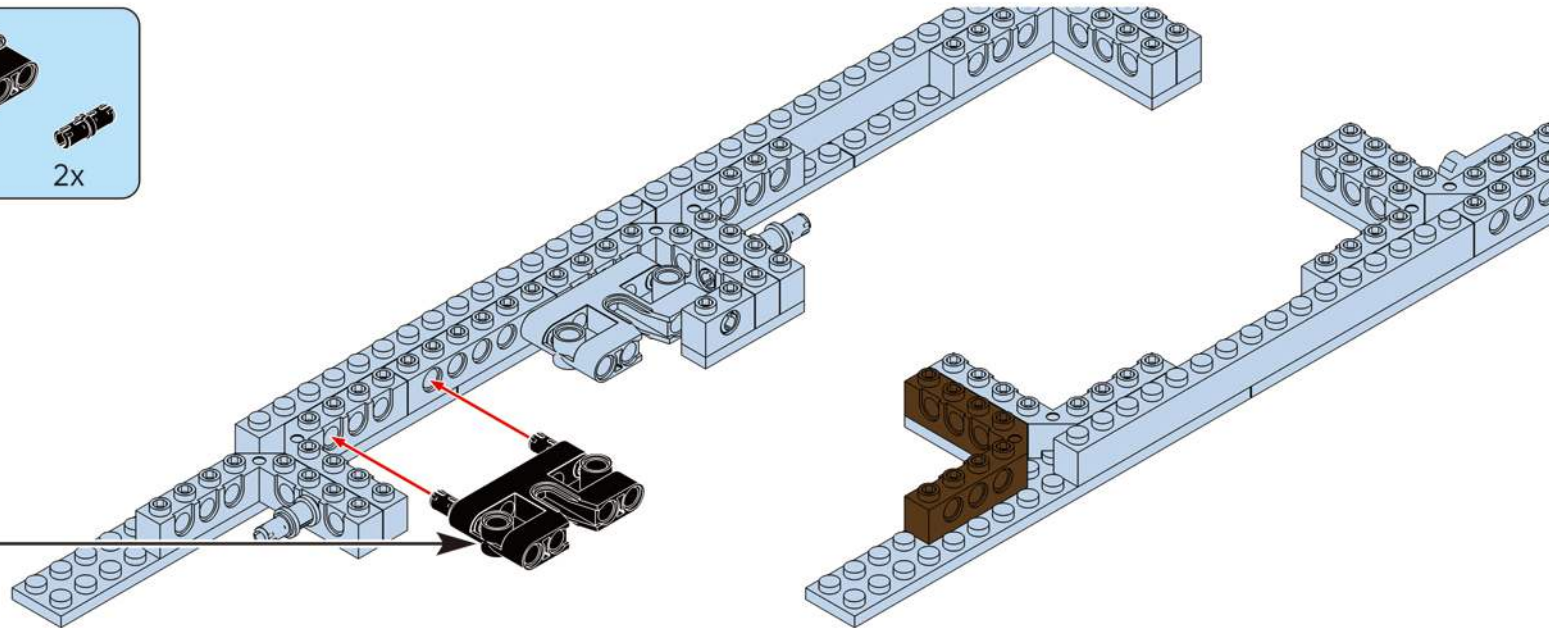
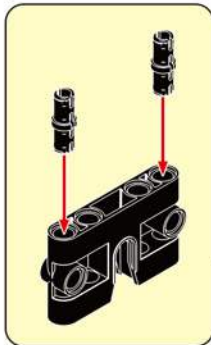

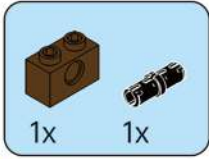

18

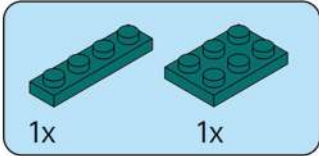
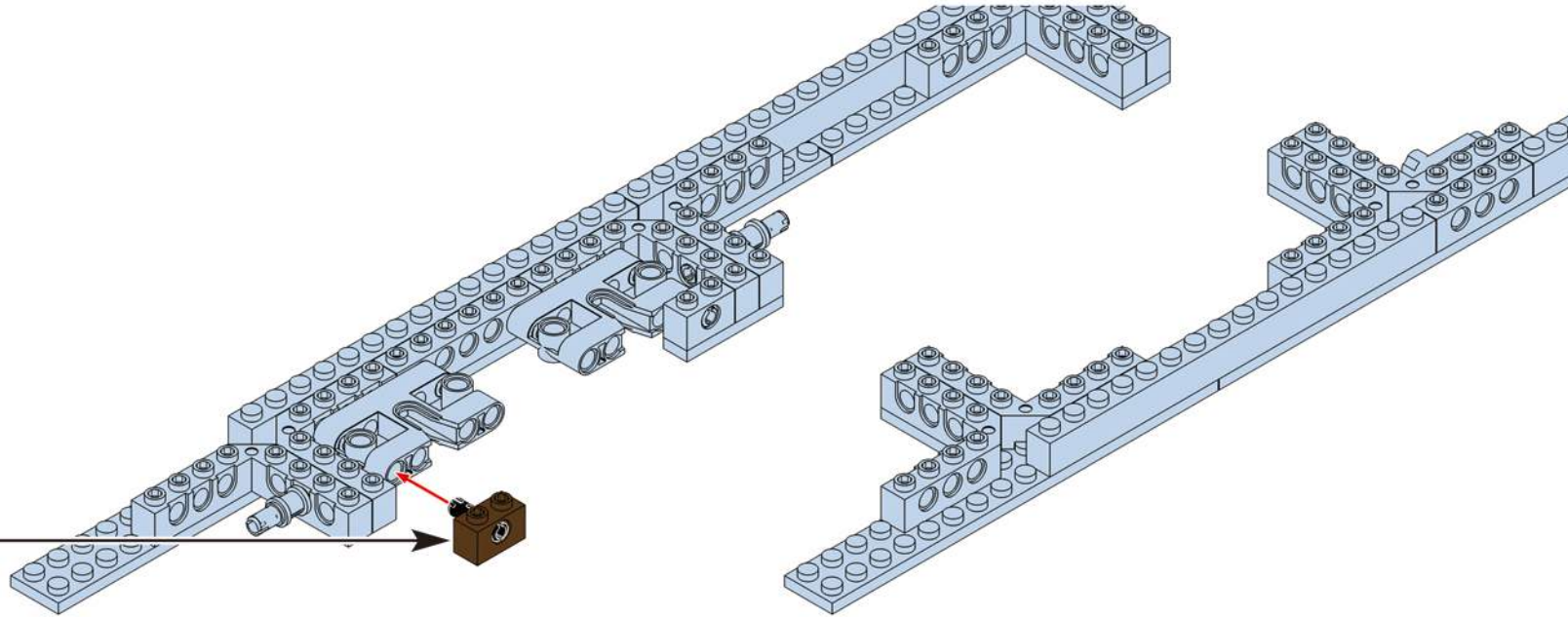
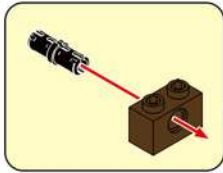

19

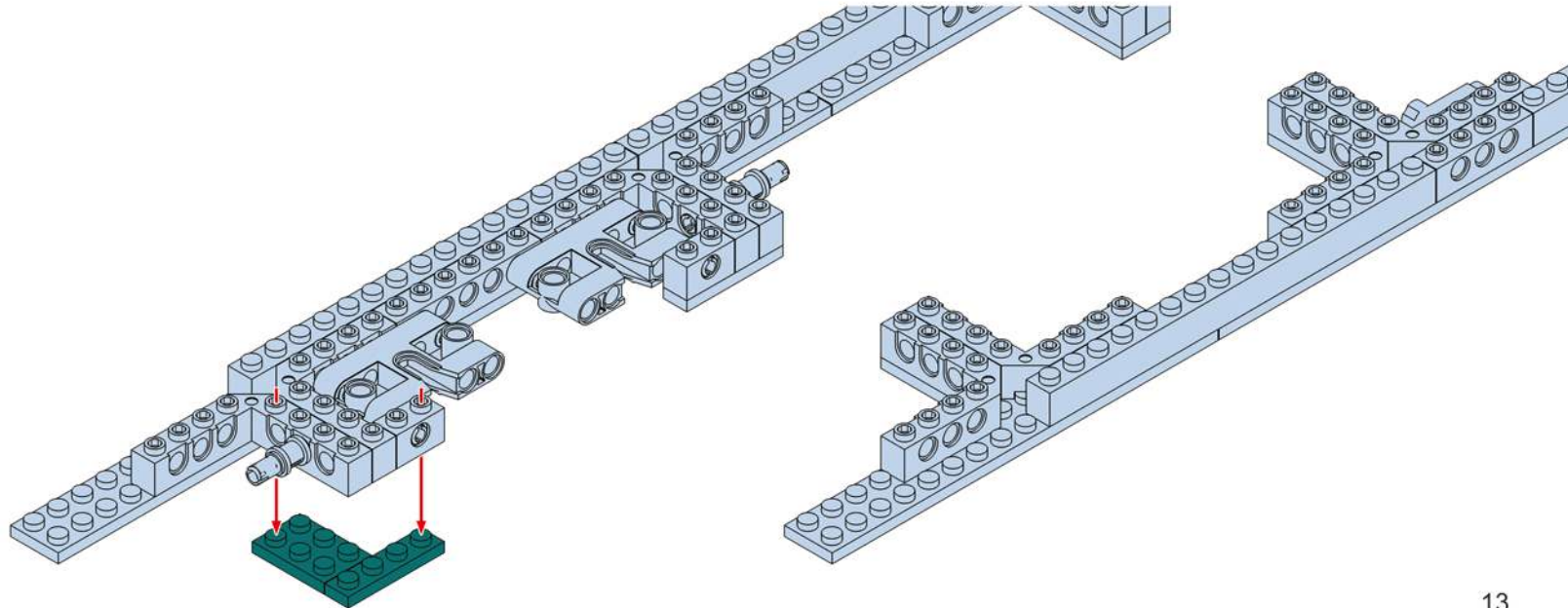

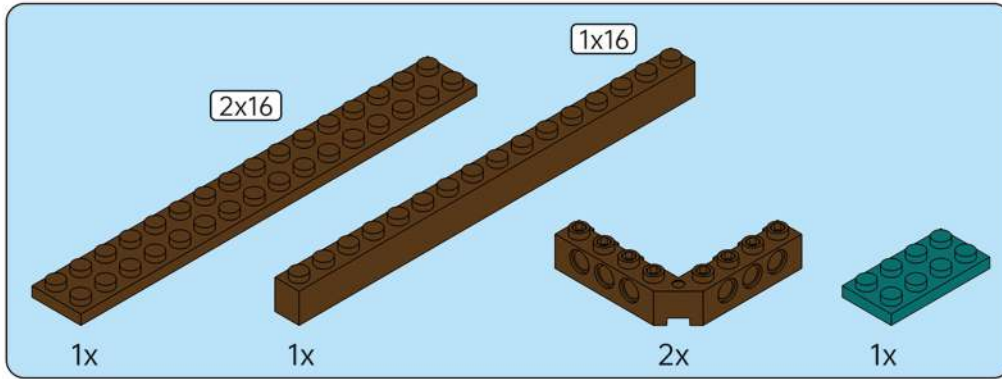

**20**

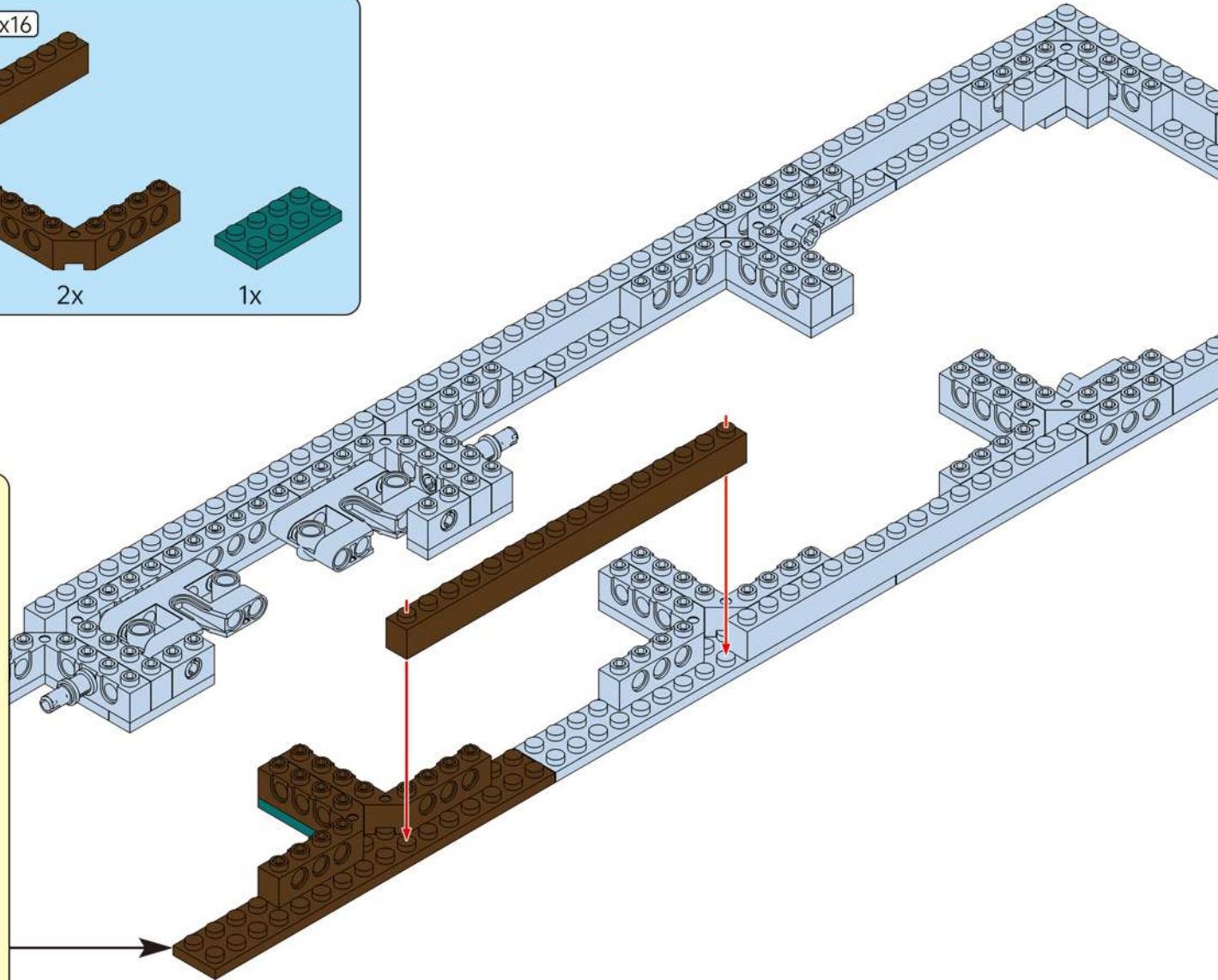
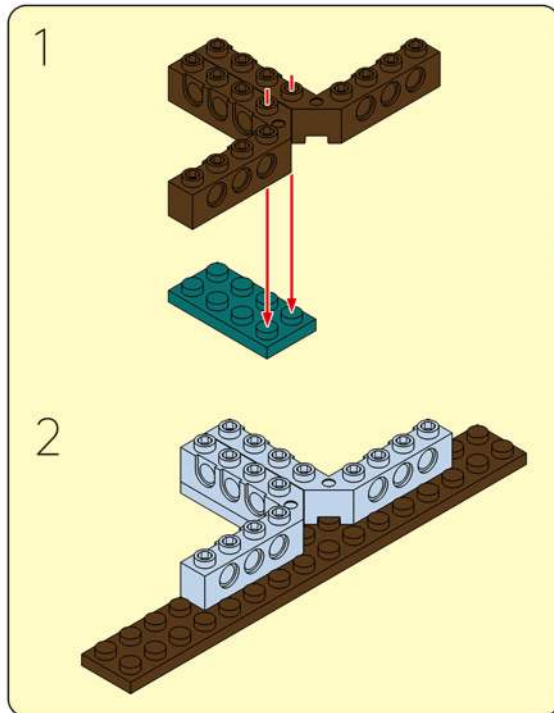

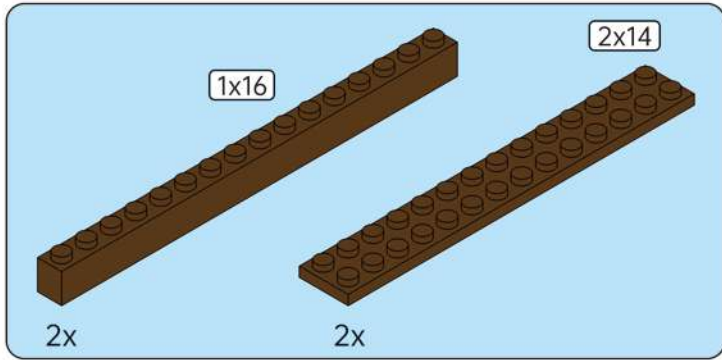

**21**

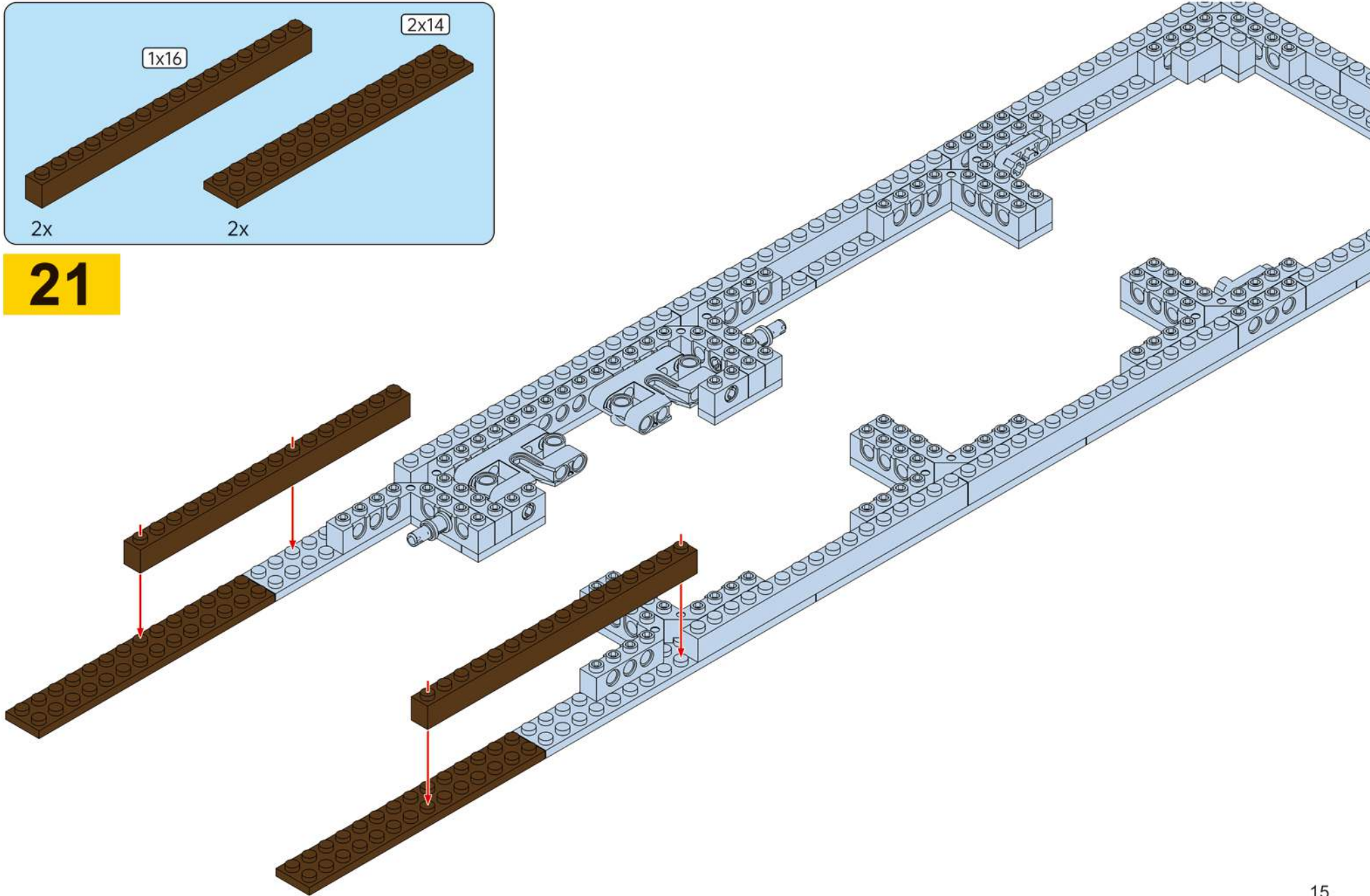

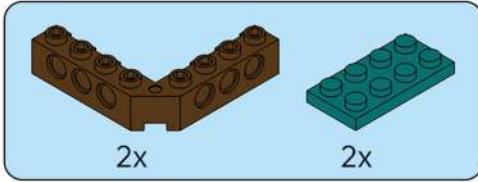

22

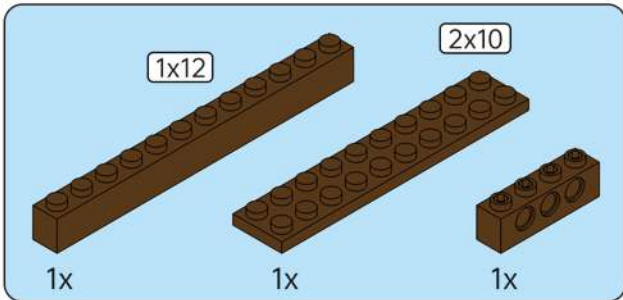
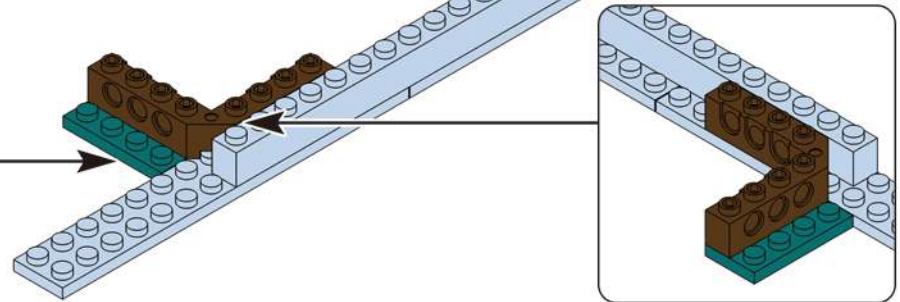
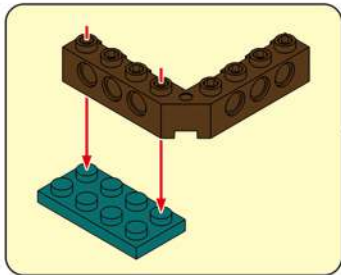
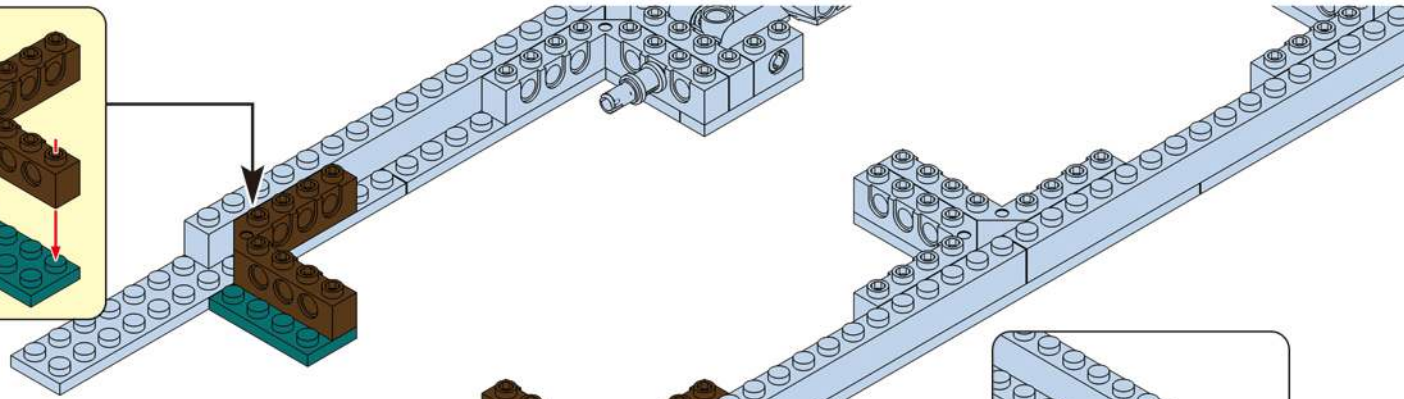
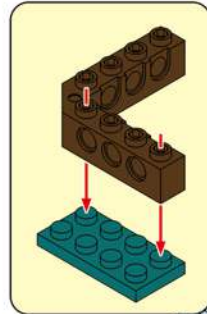

23

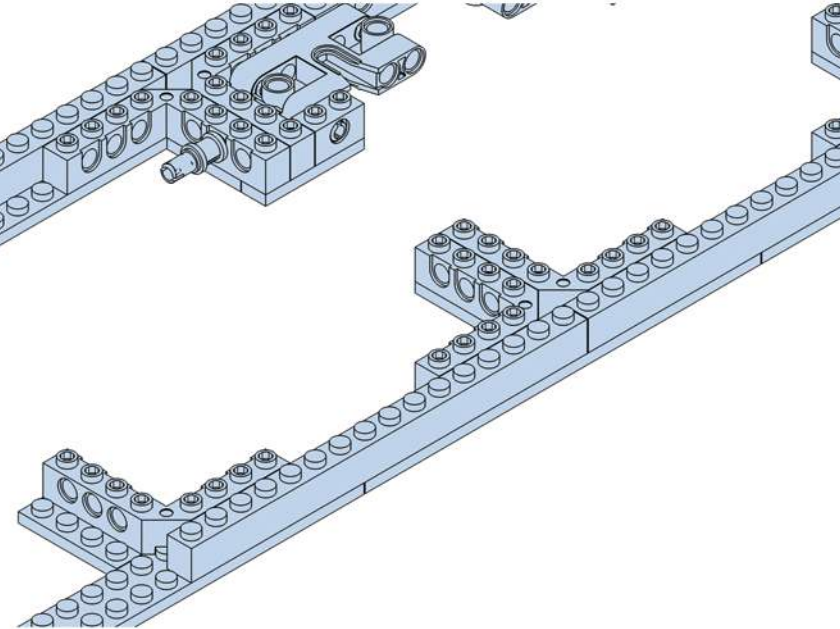
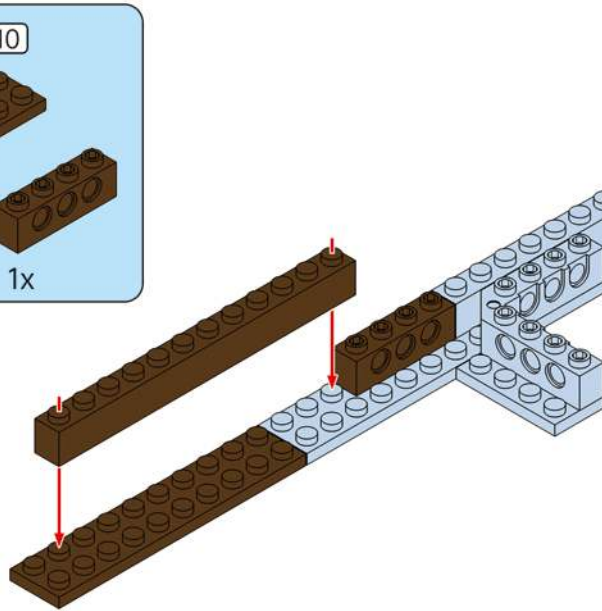

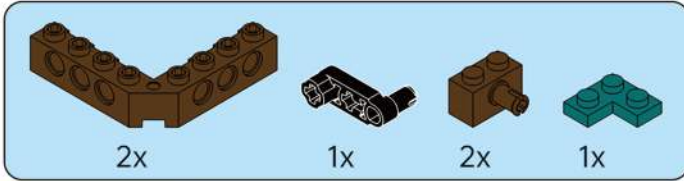

# 24

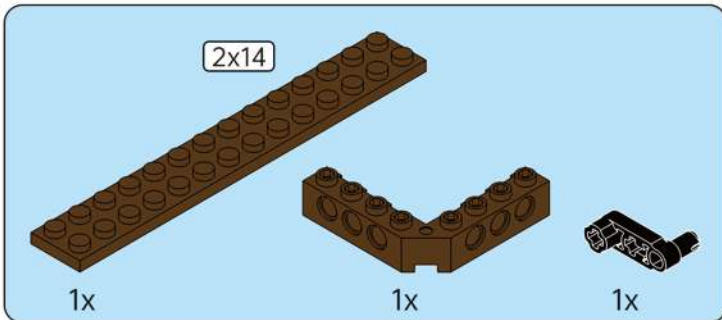
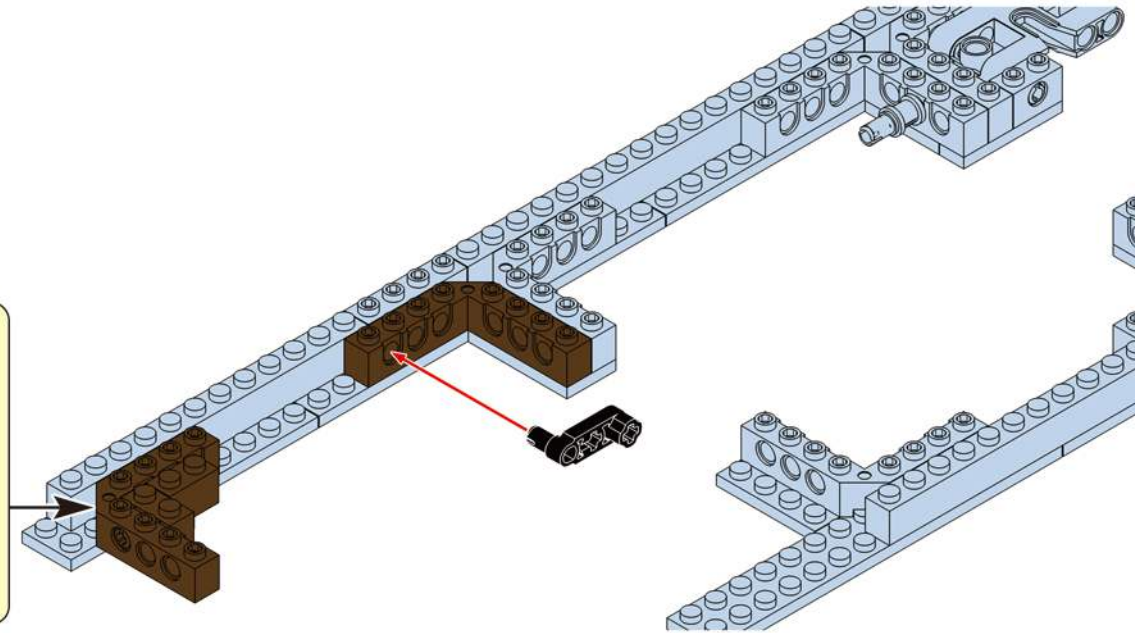
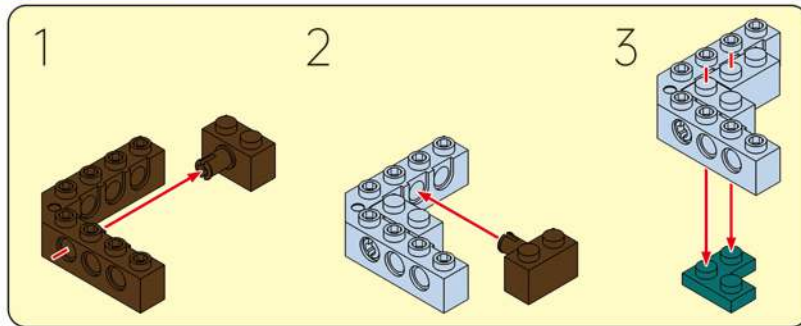

# 25

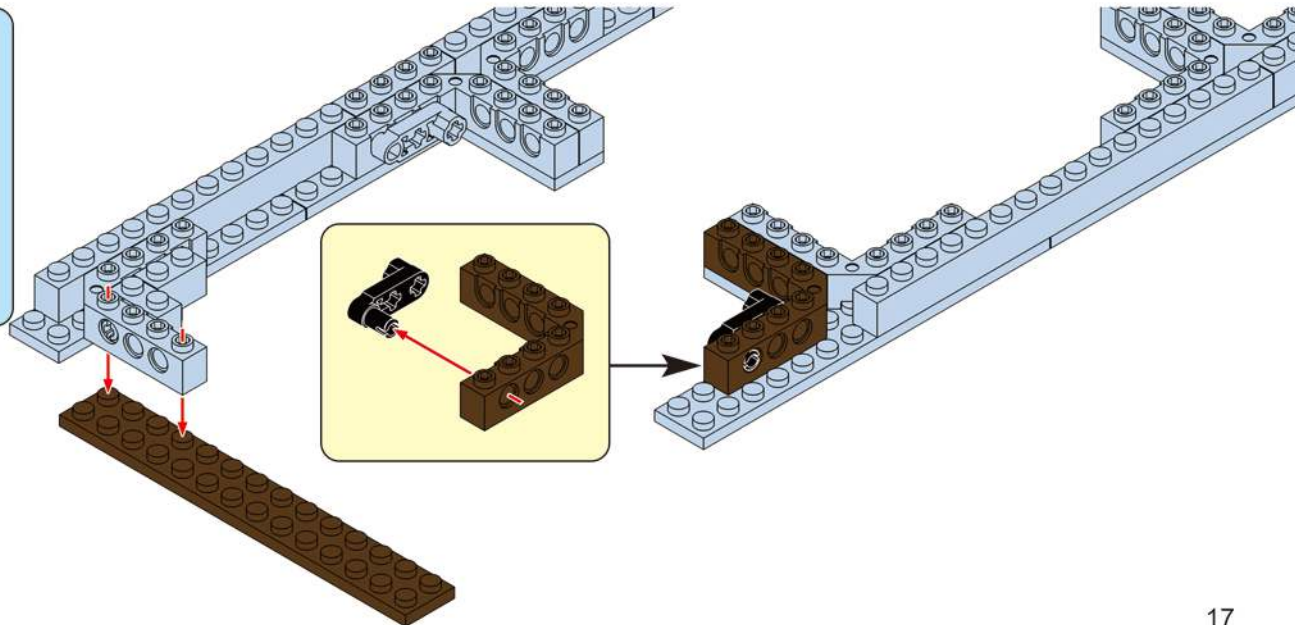

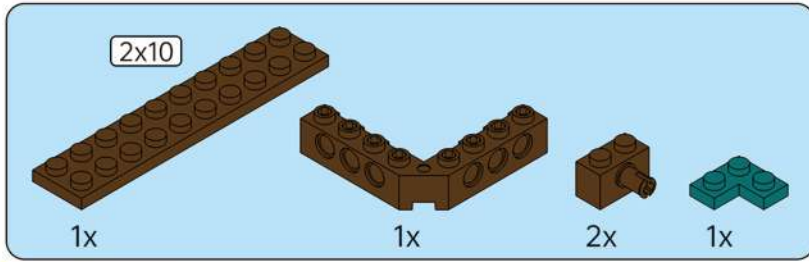

26

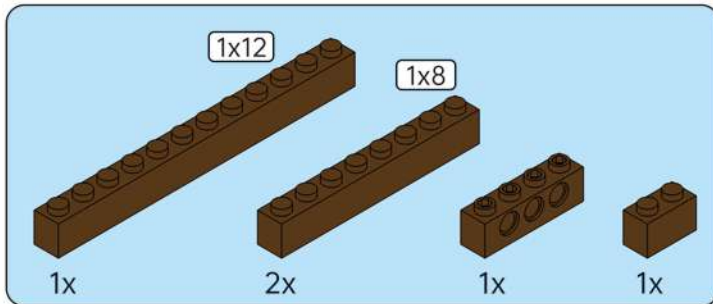
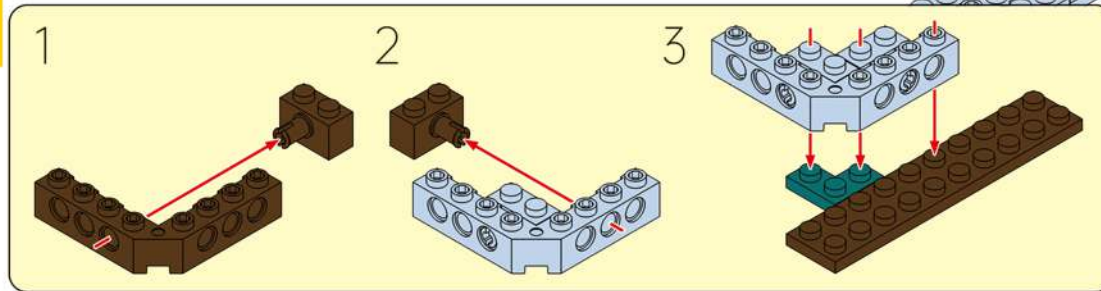

27

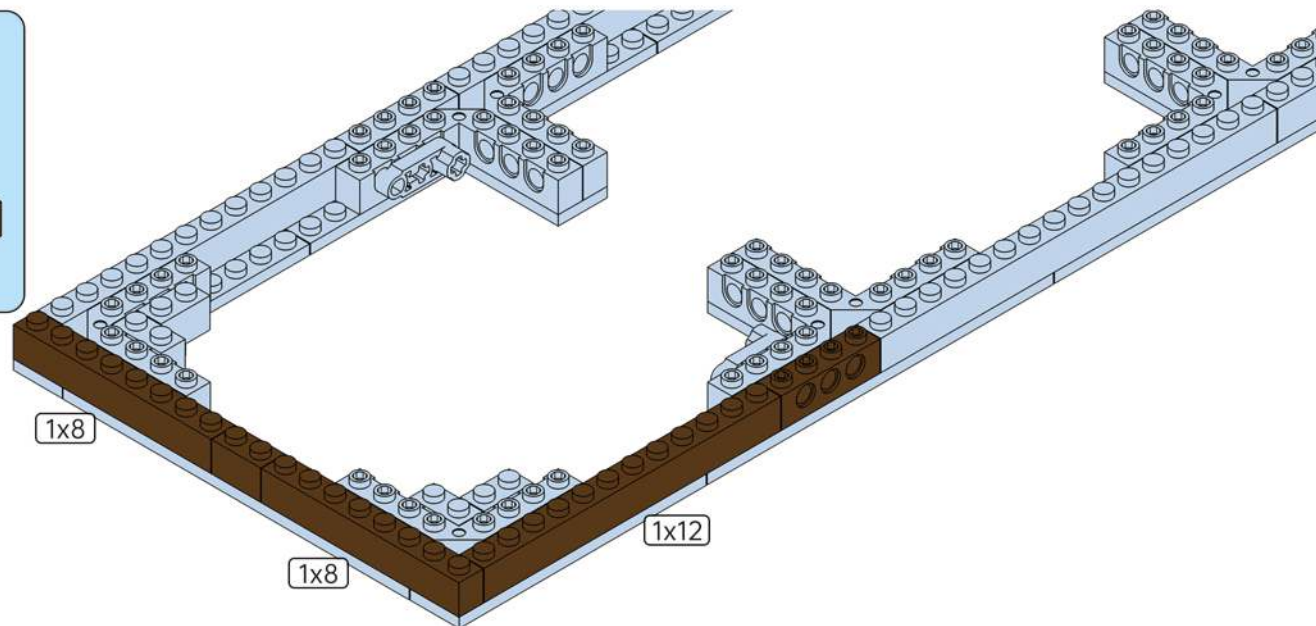

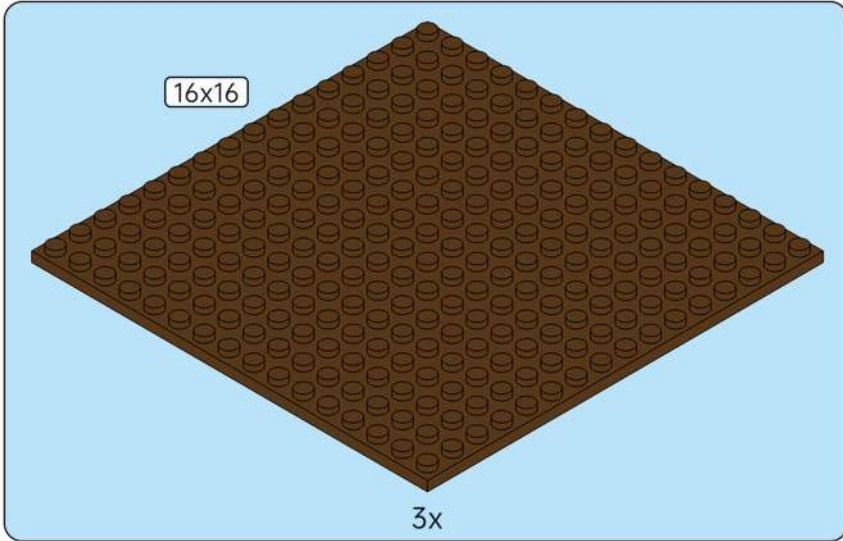

**28**

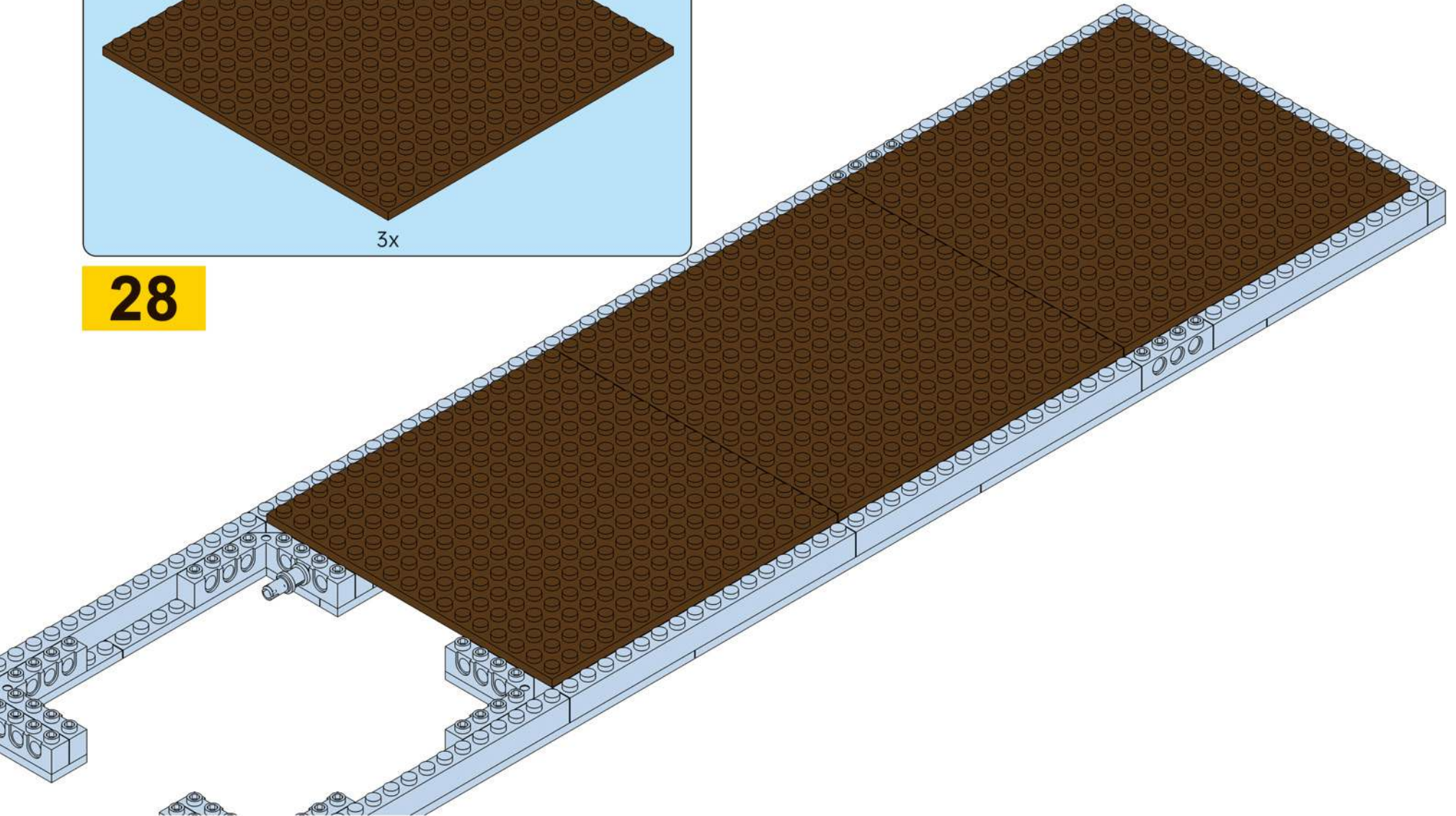

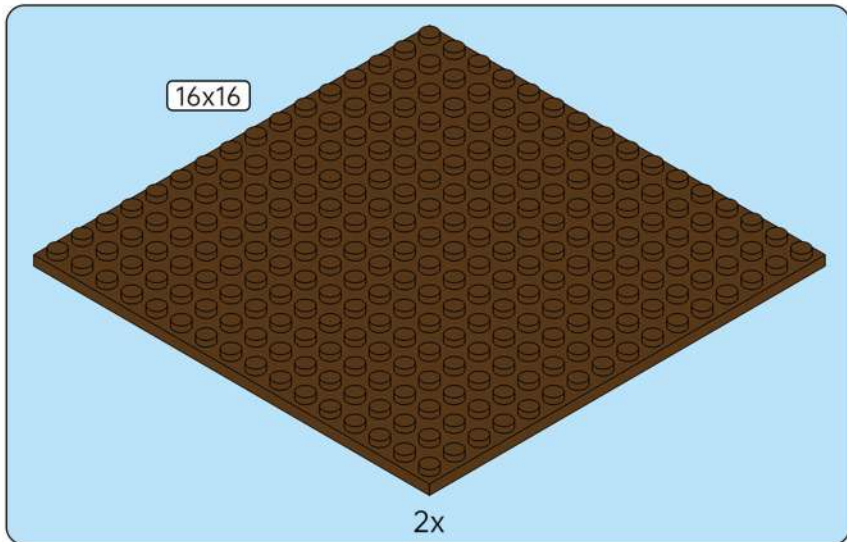

29

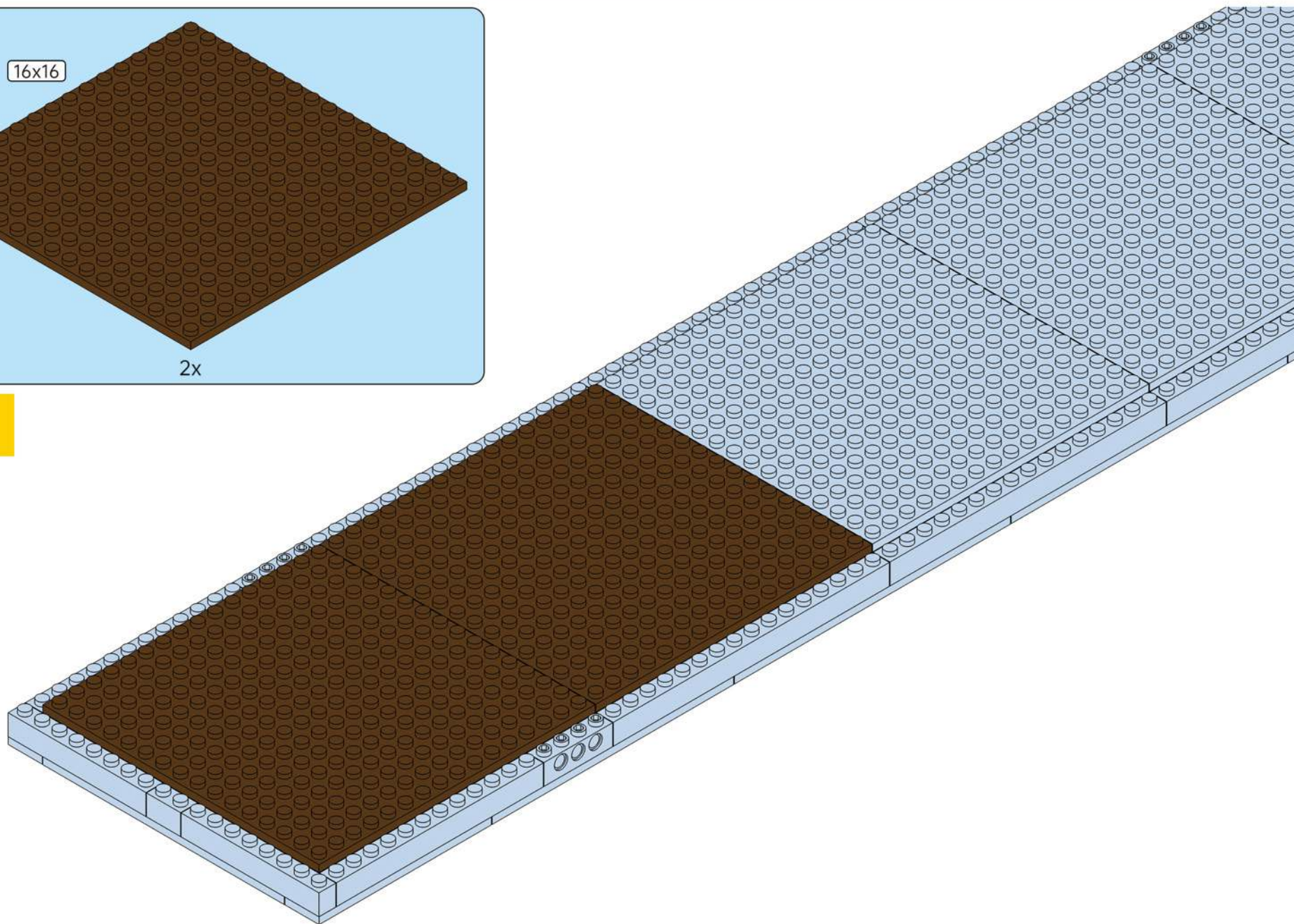

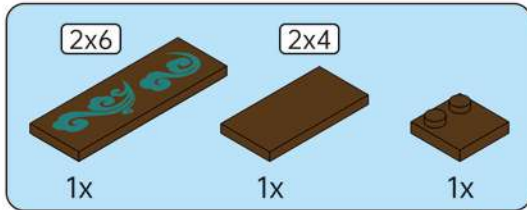

30

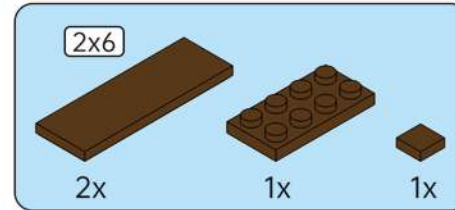
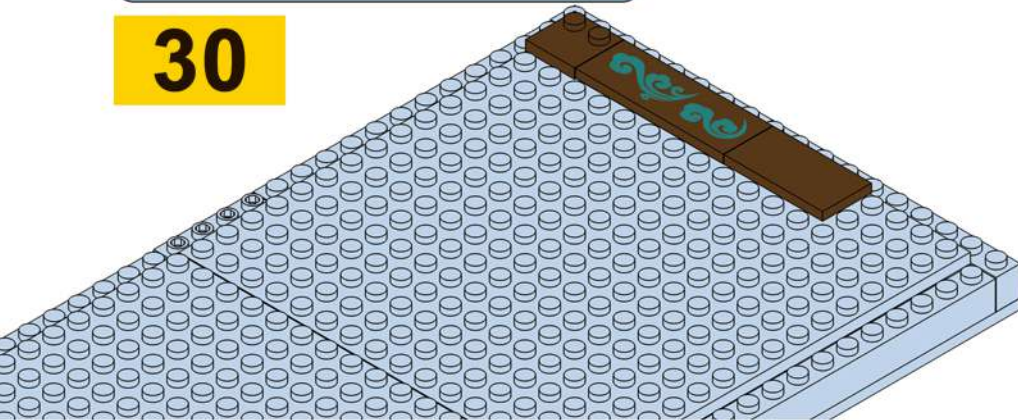

31

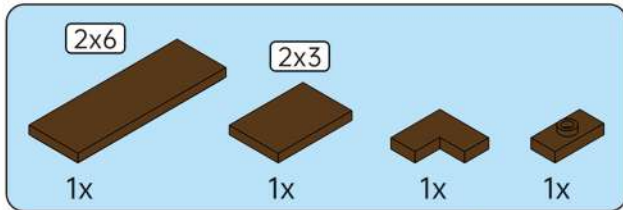
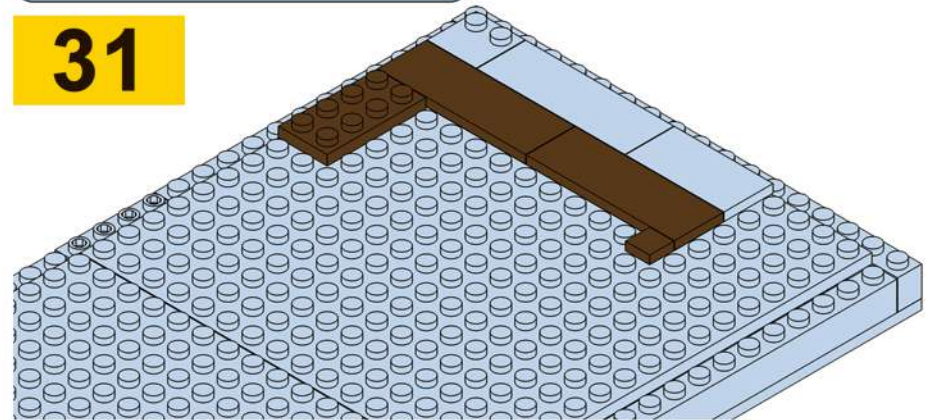

32

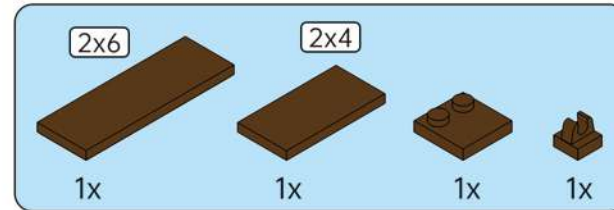
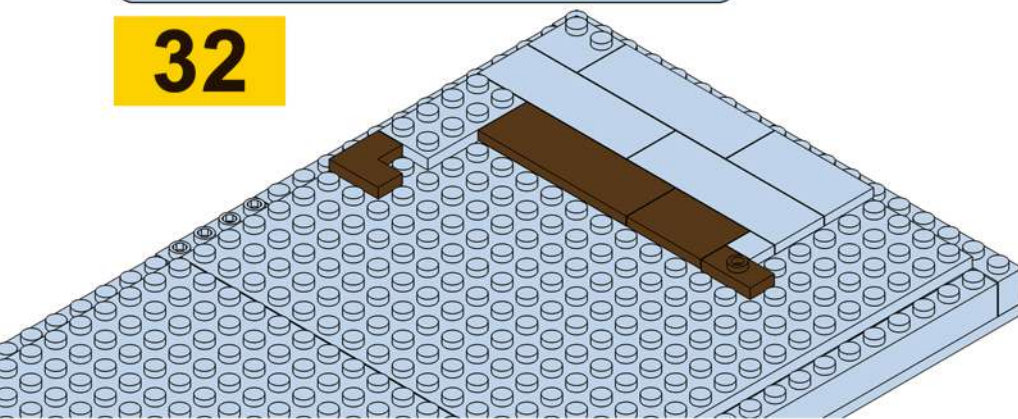

33

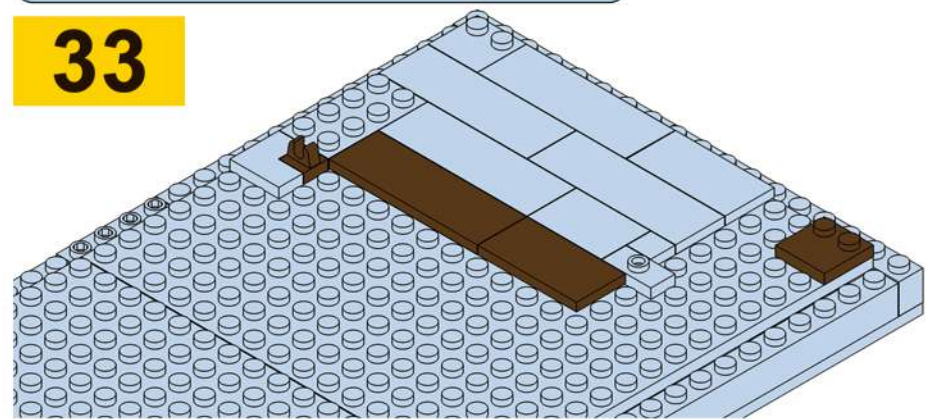

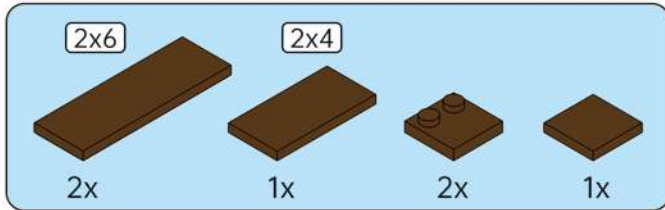

34

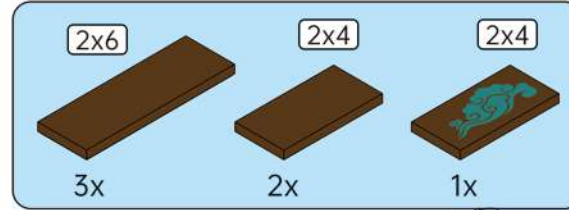
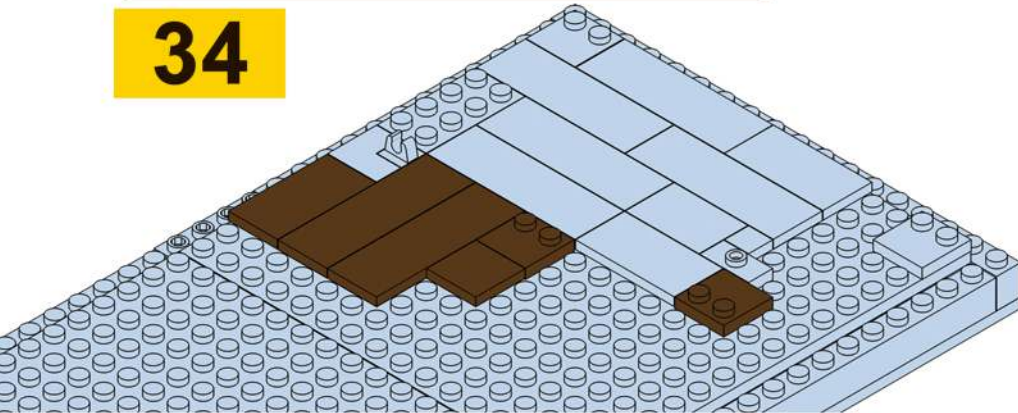

35

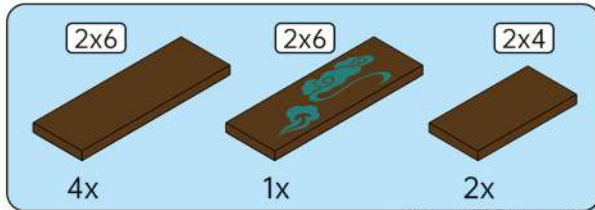
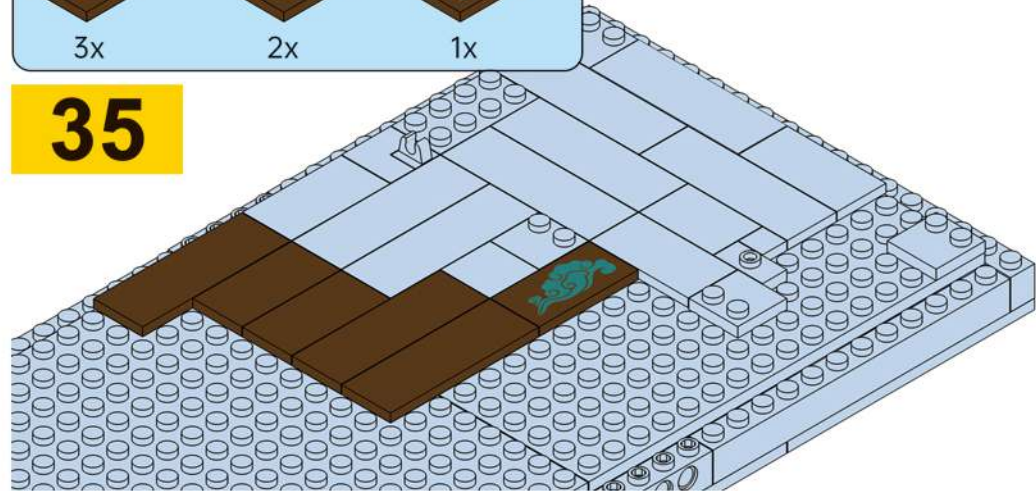

36

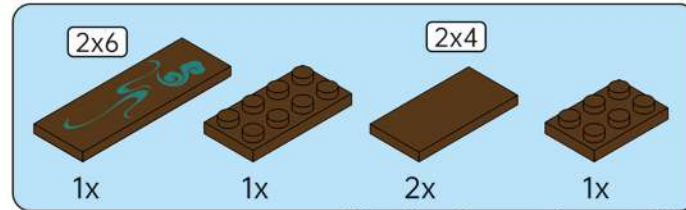
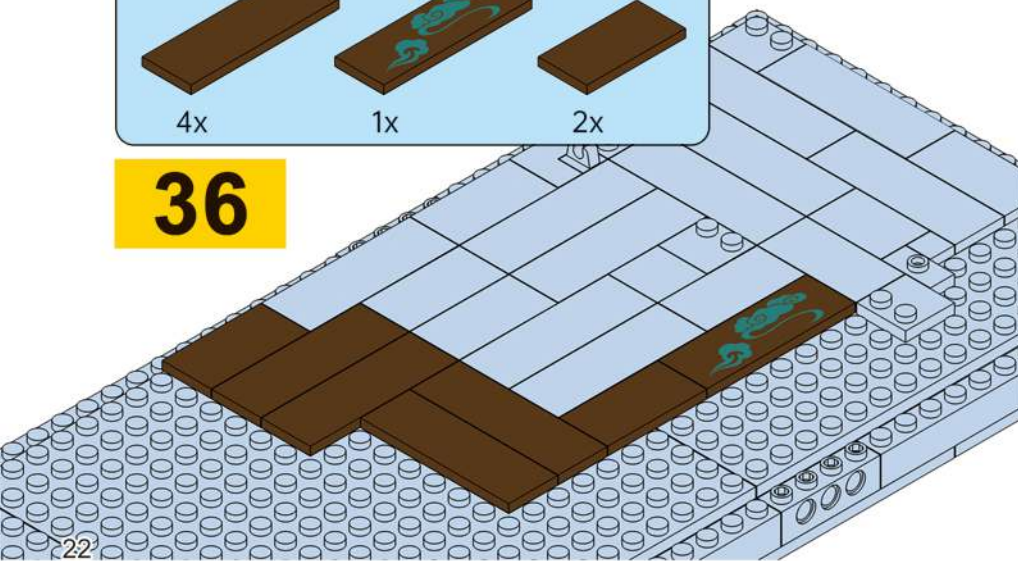

37

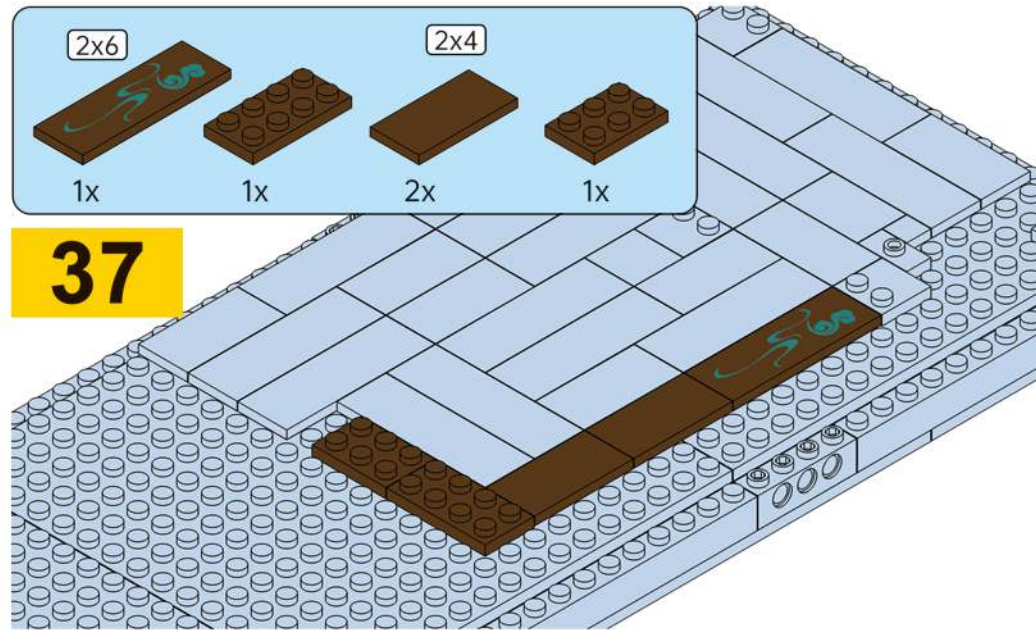

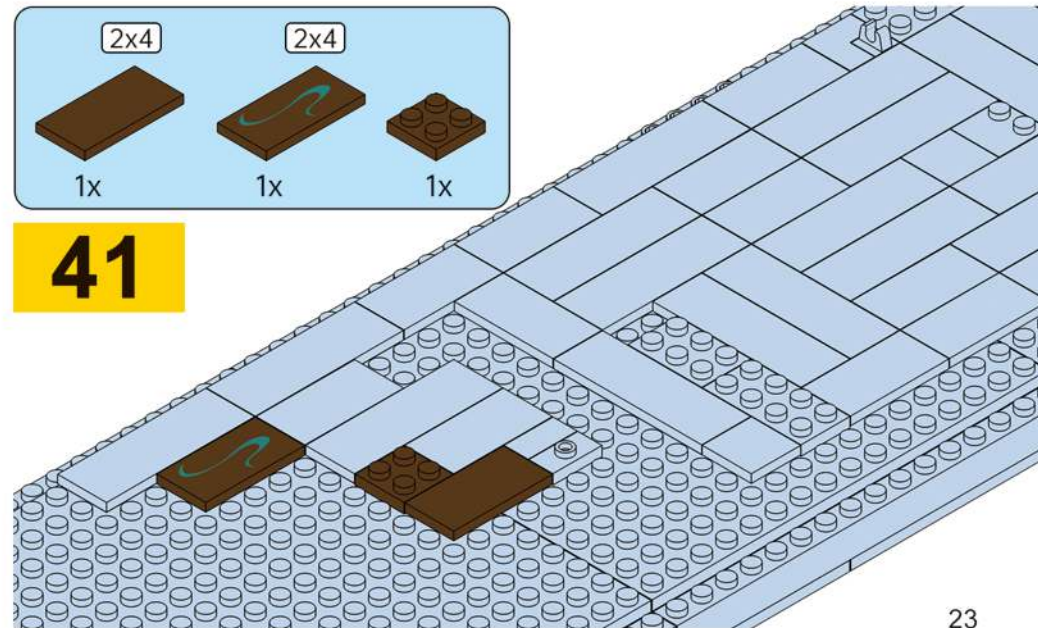
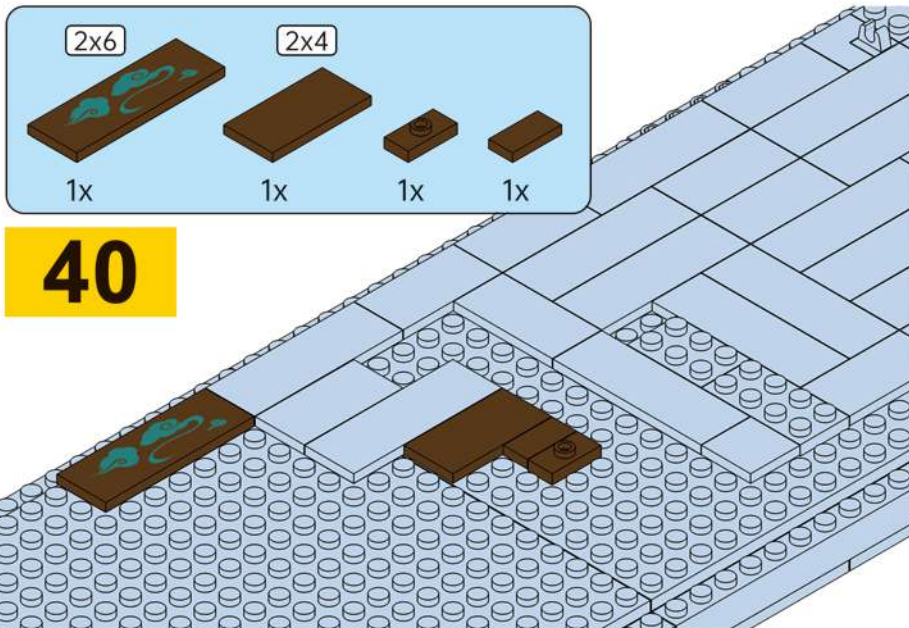
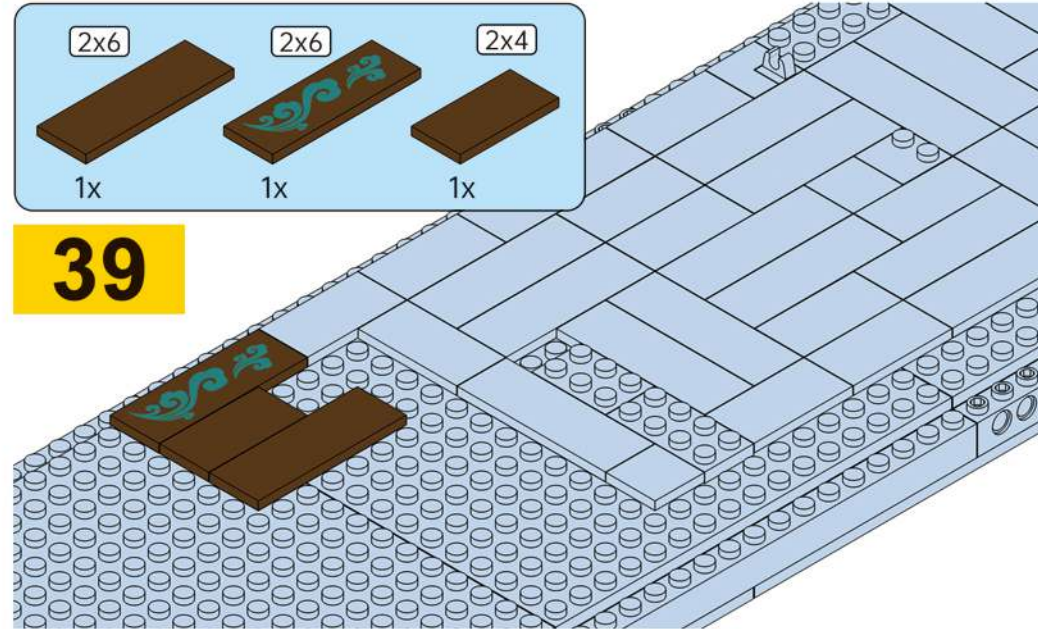
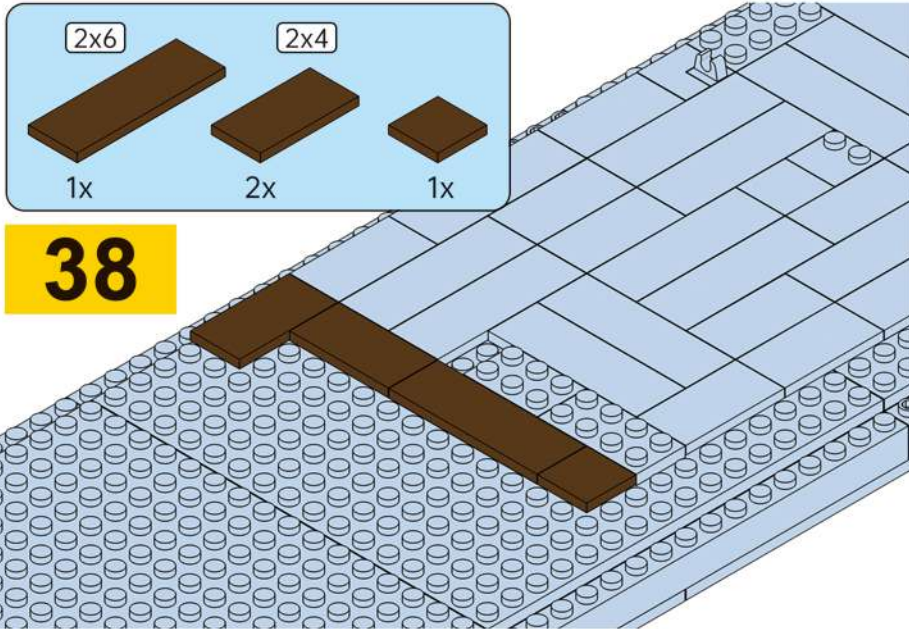

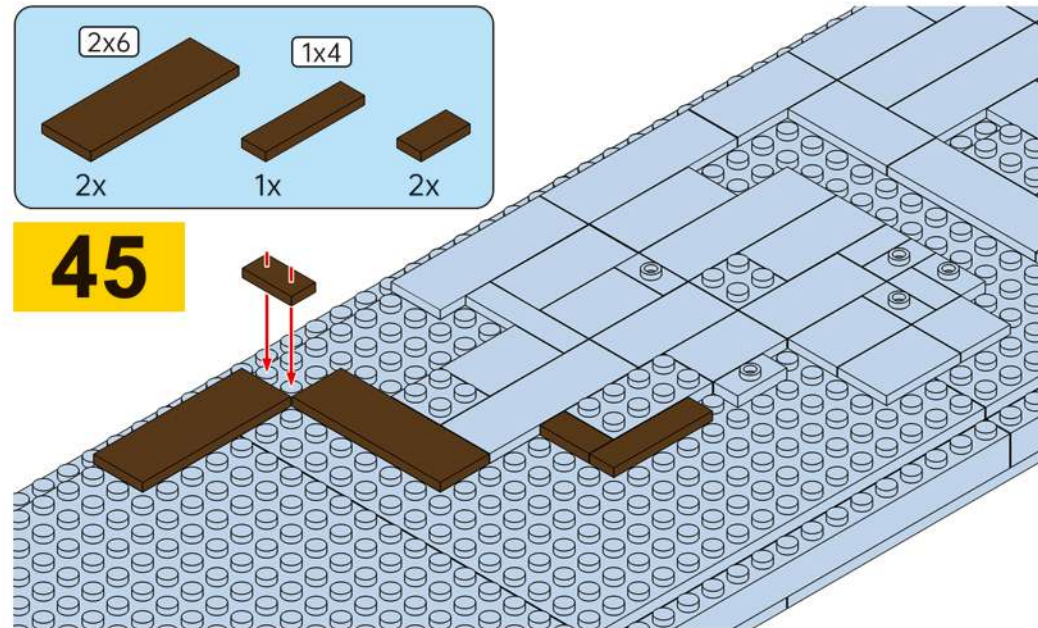
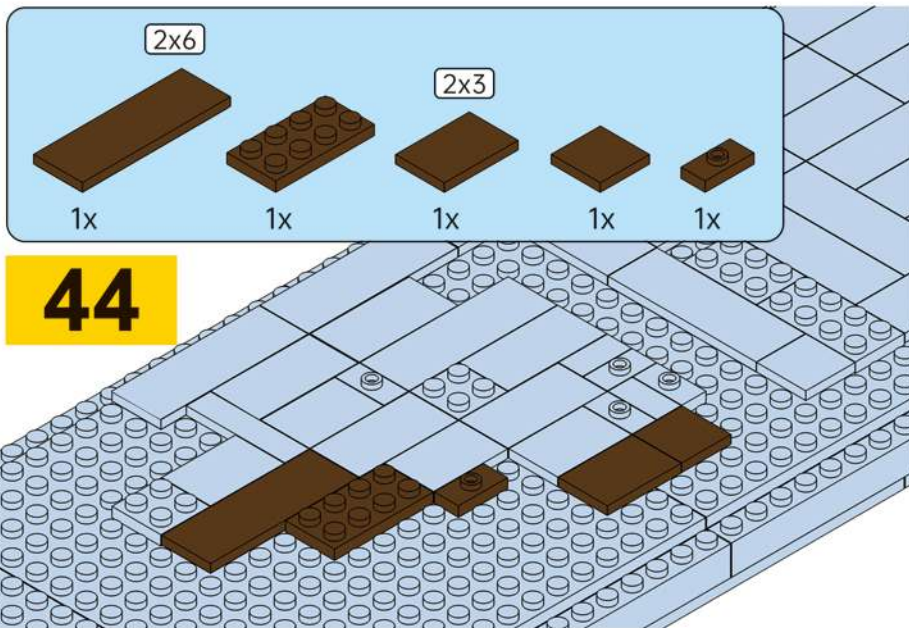
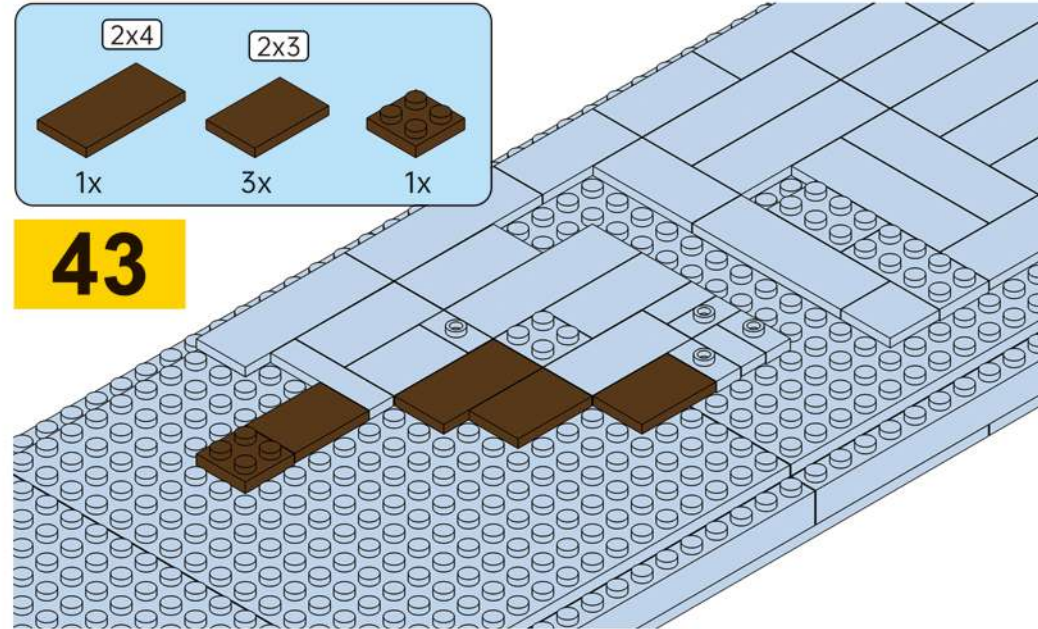
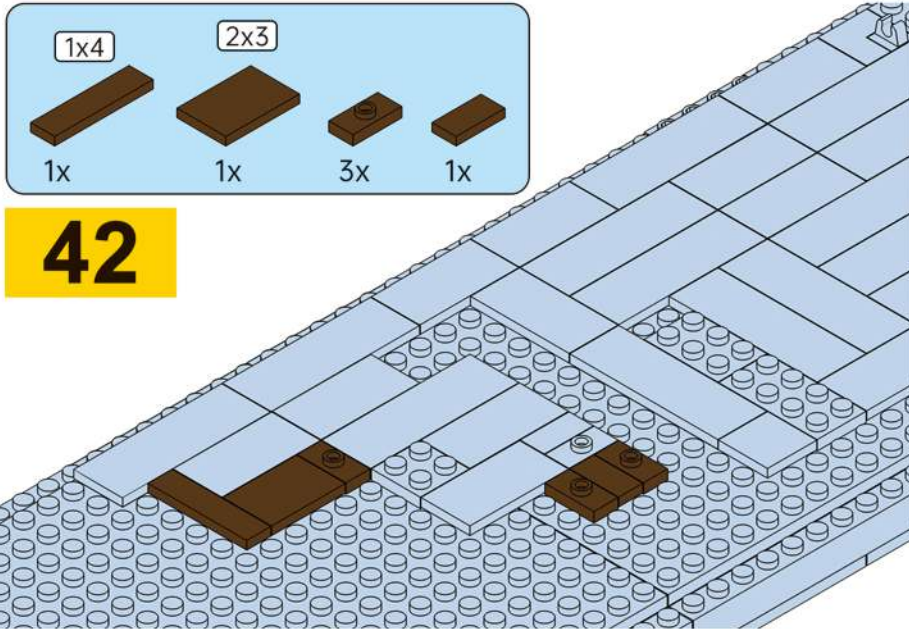

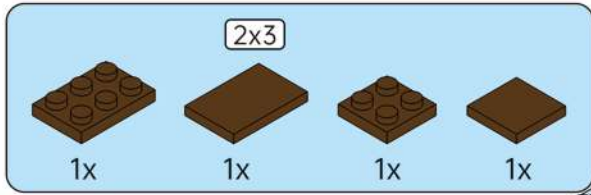

46

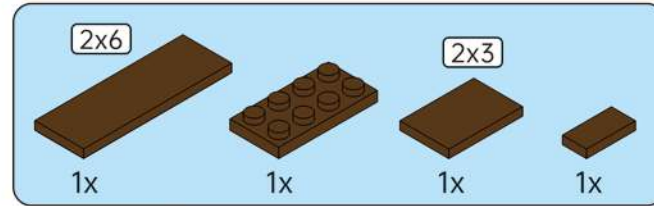
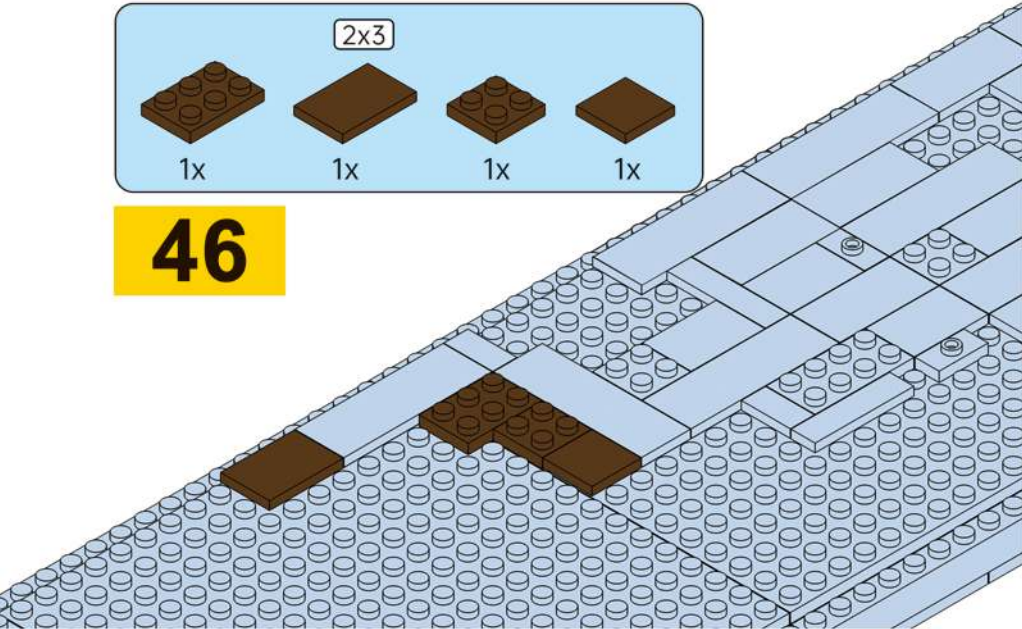

47

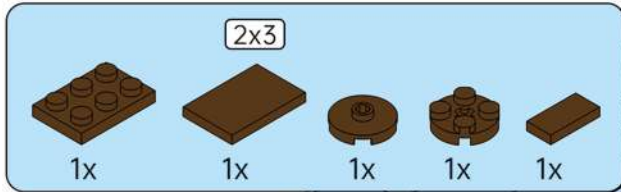
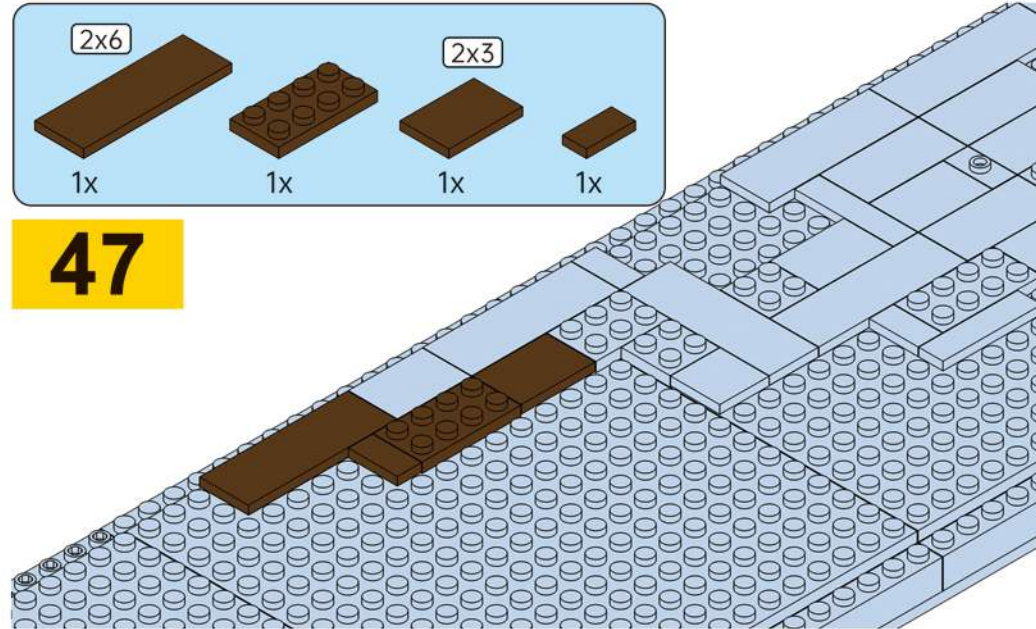

48

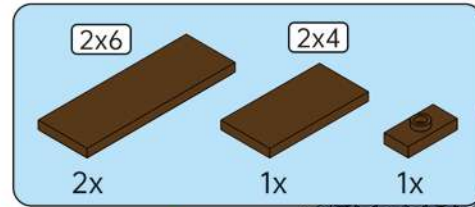
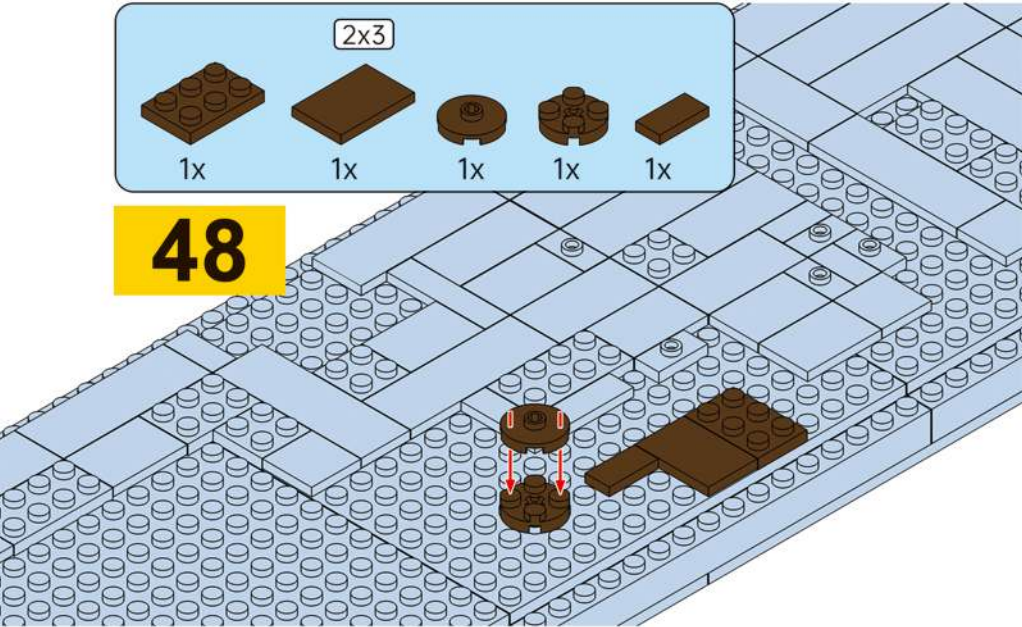

49

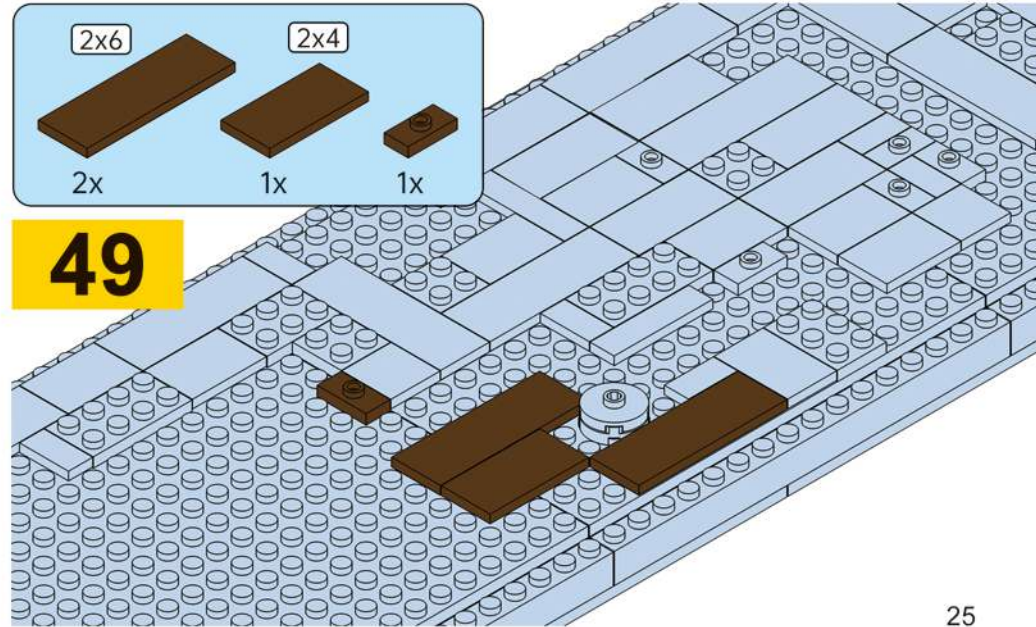

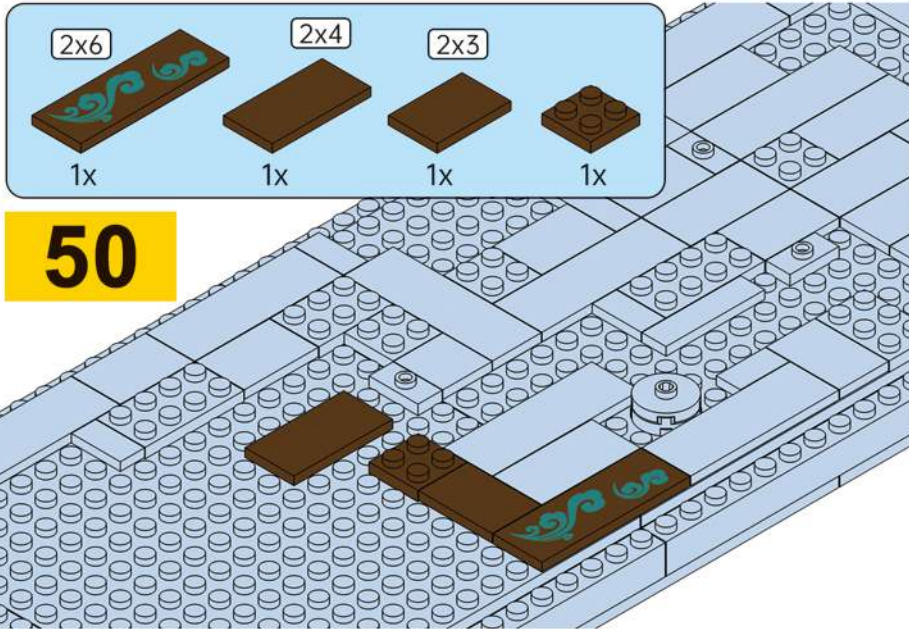

50

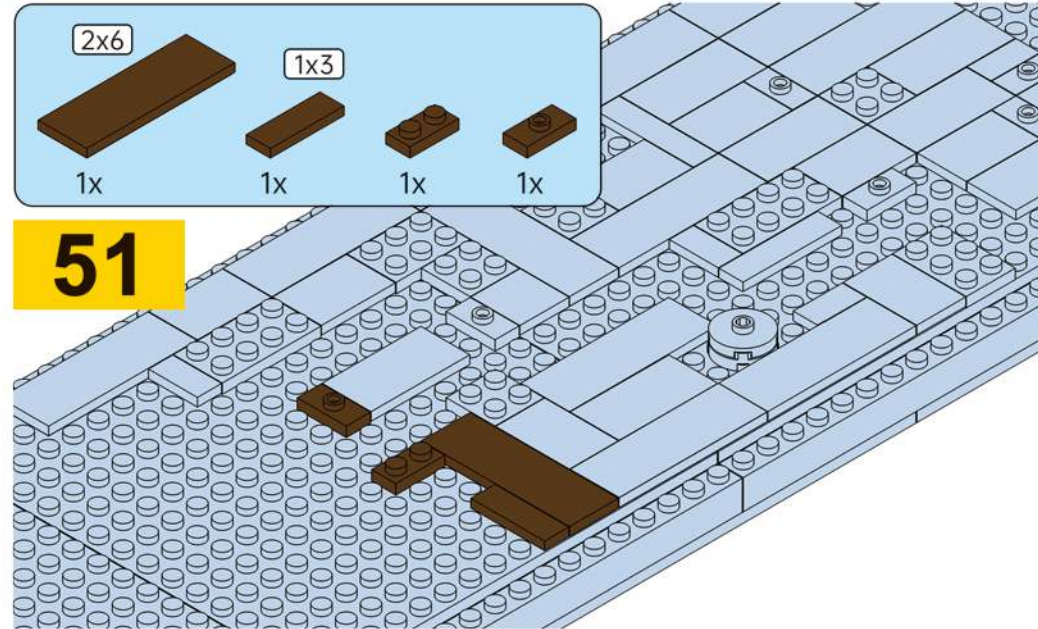

51

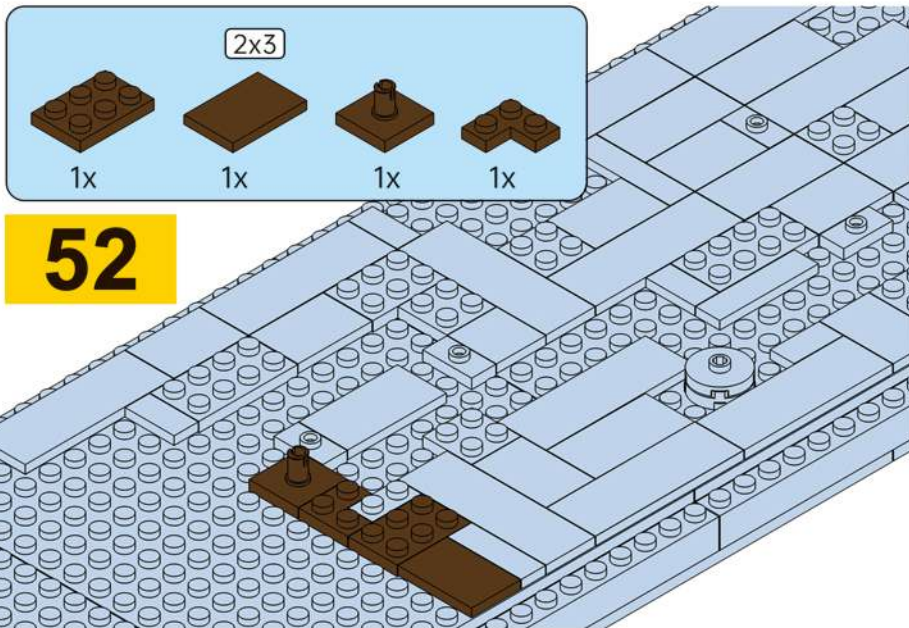

52

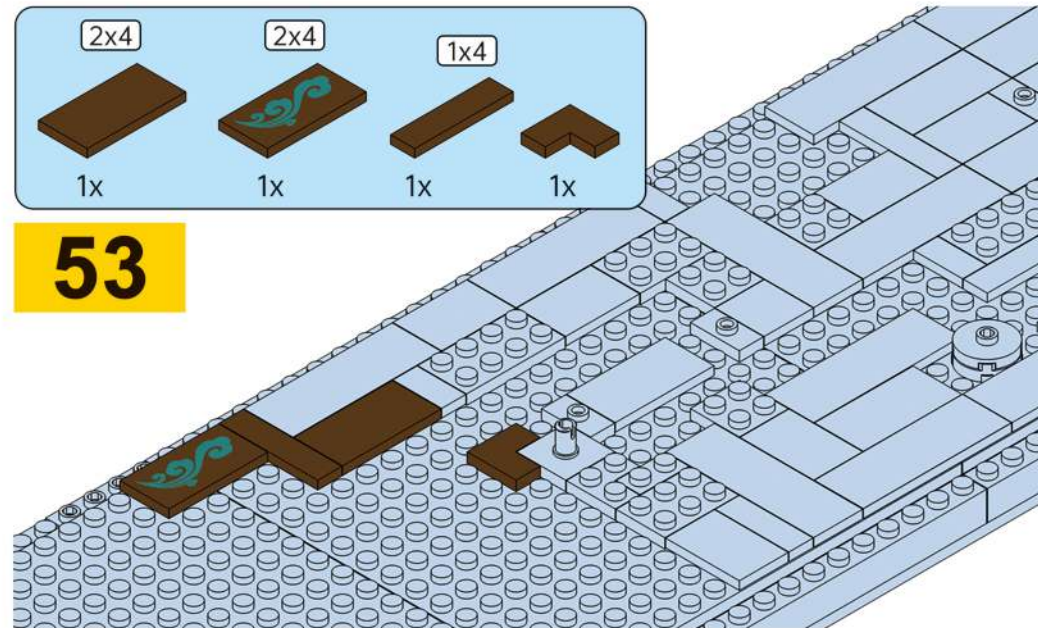

53

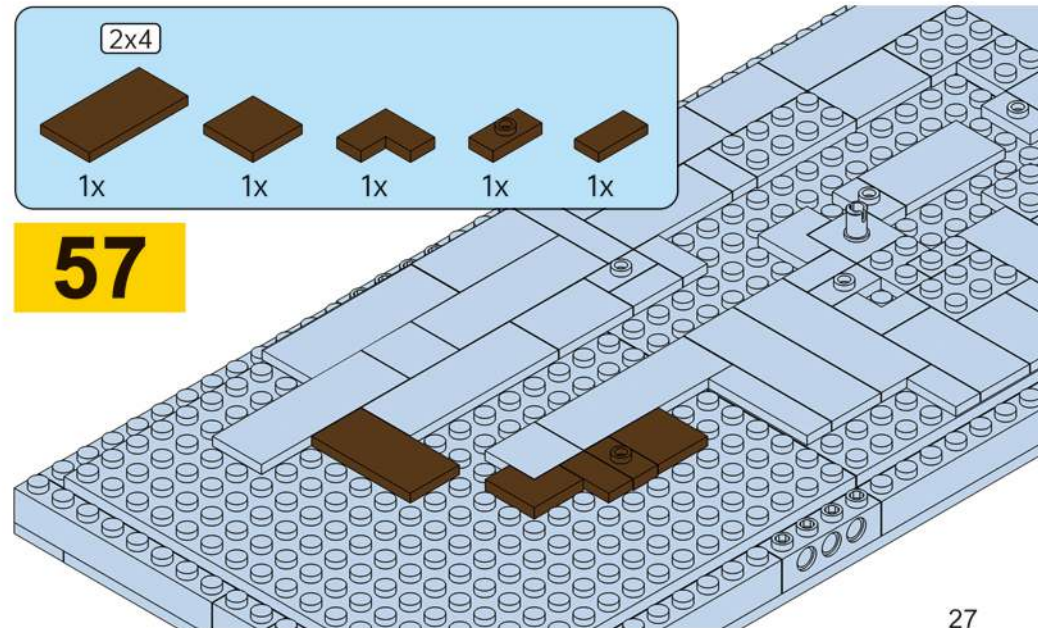
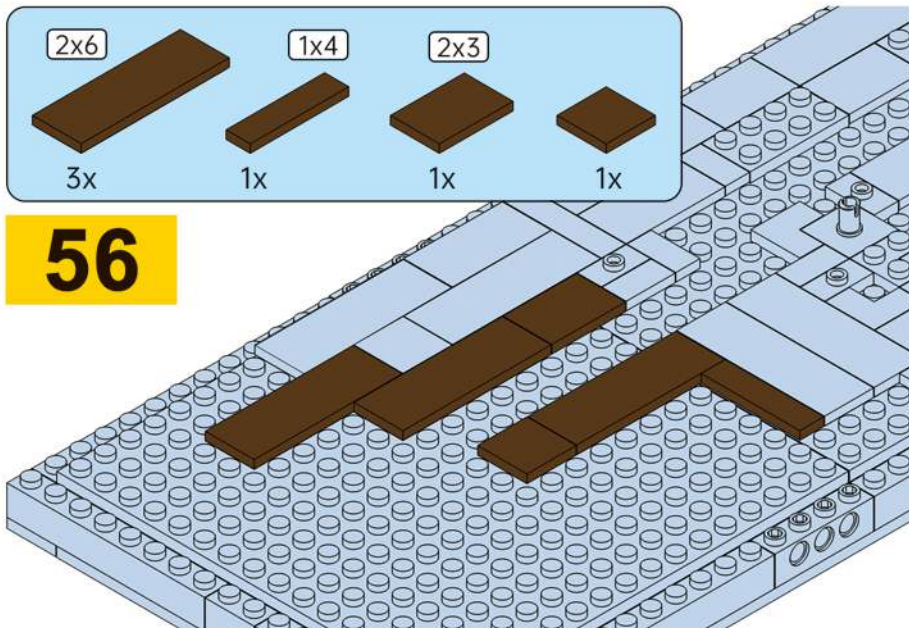
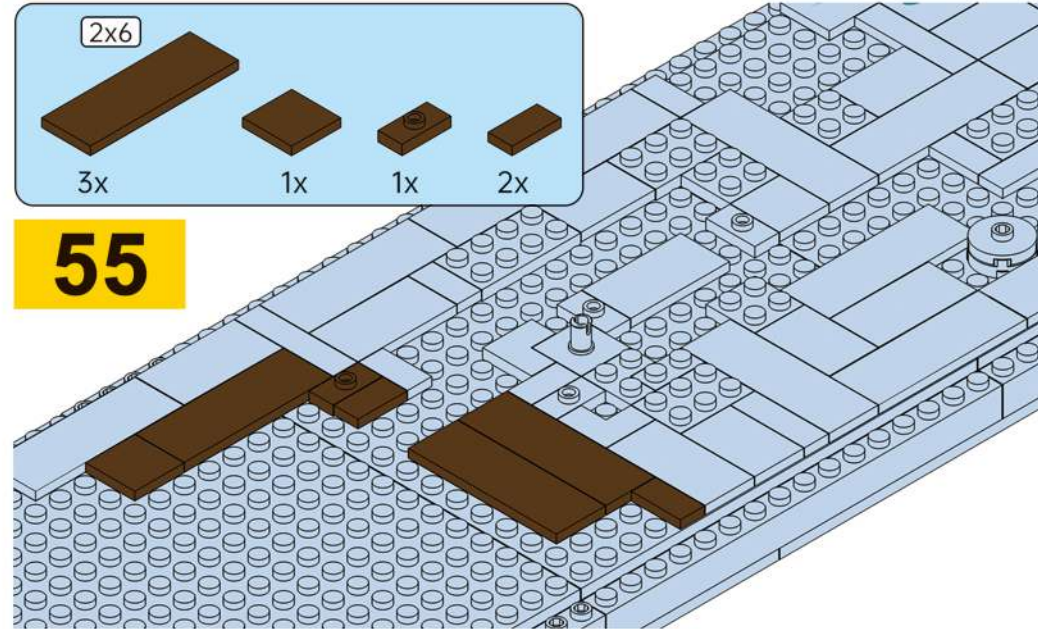
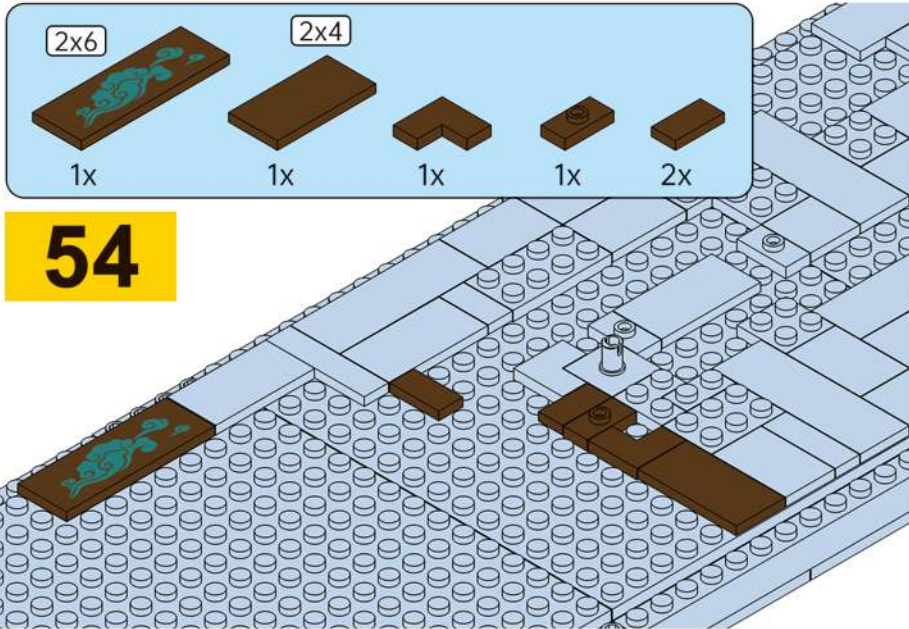

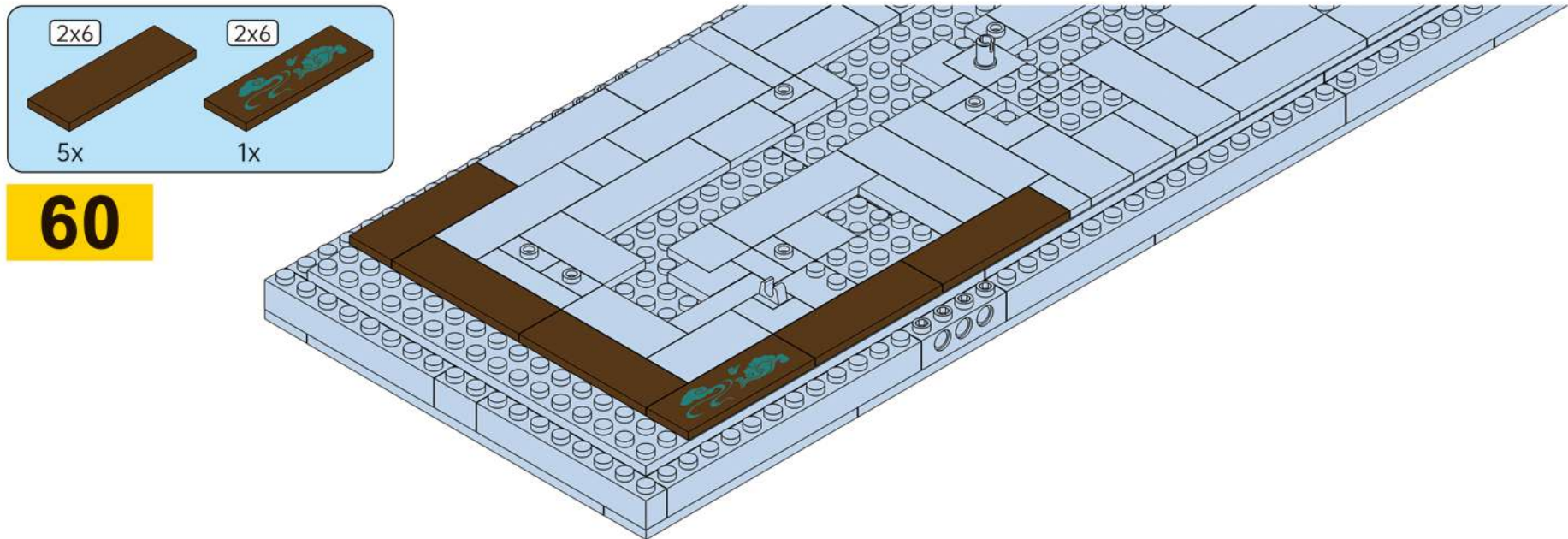
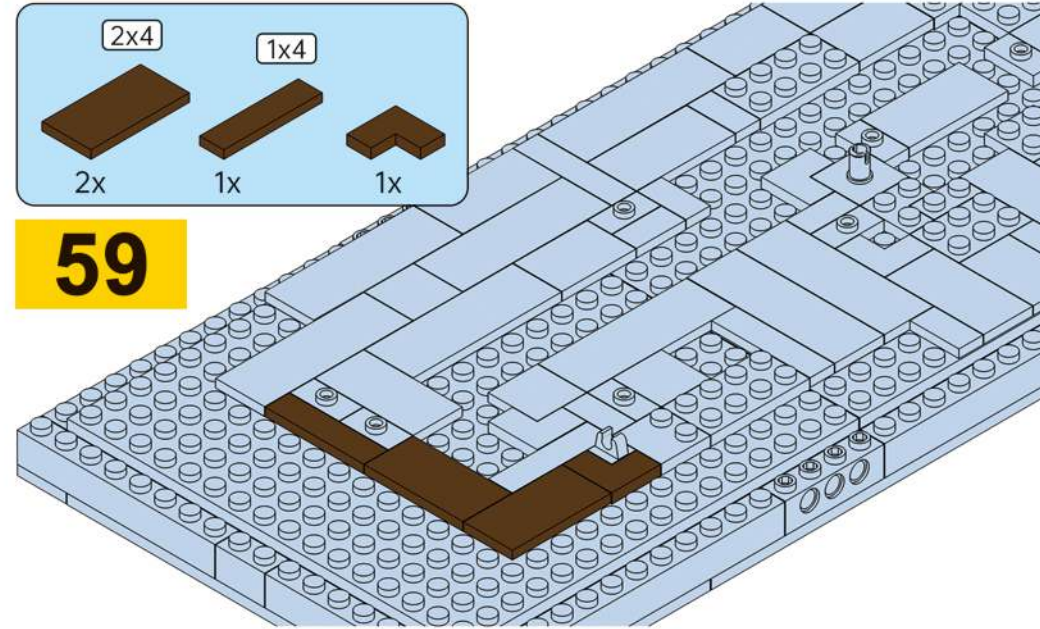
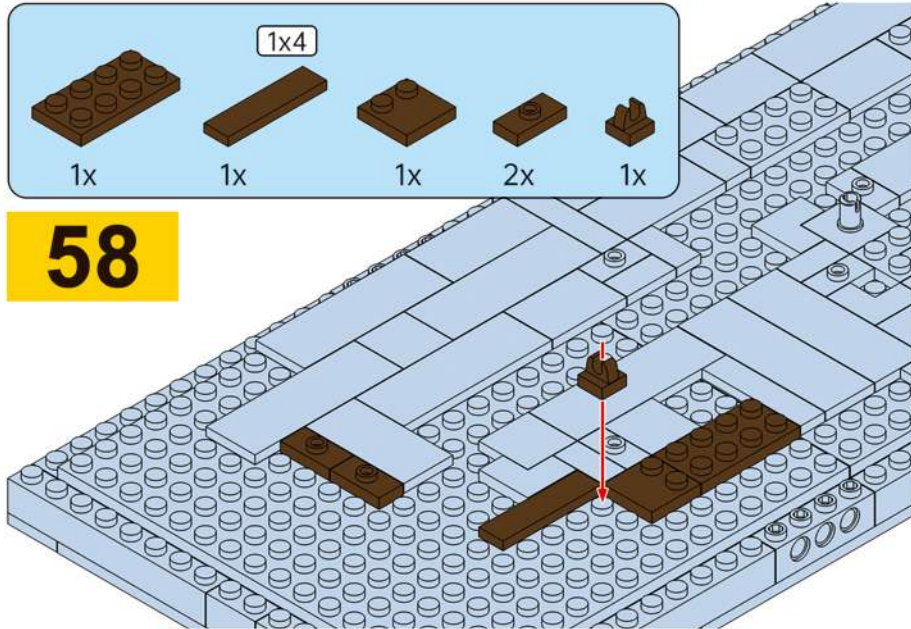

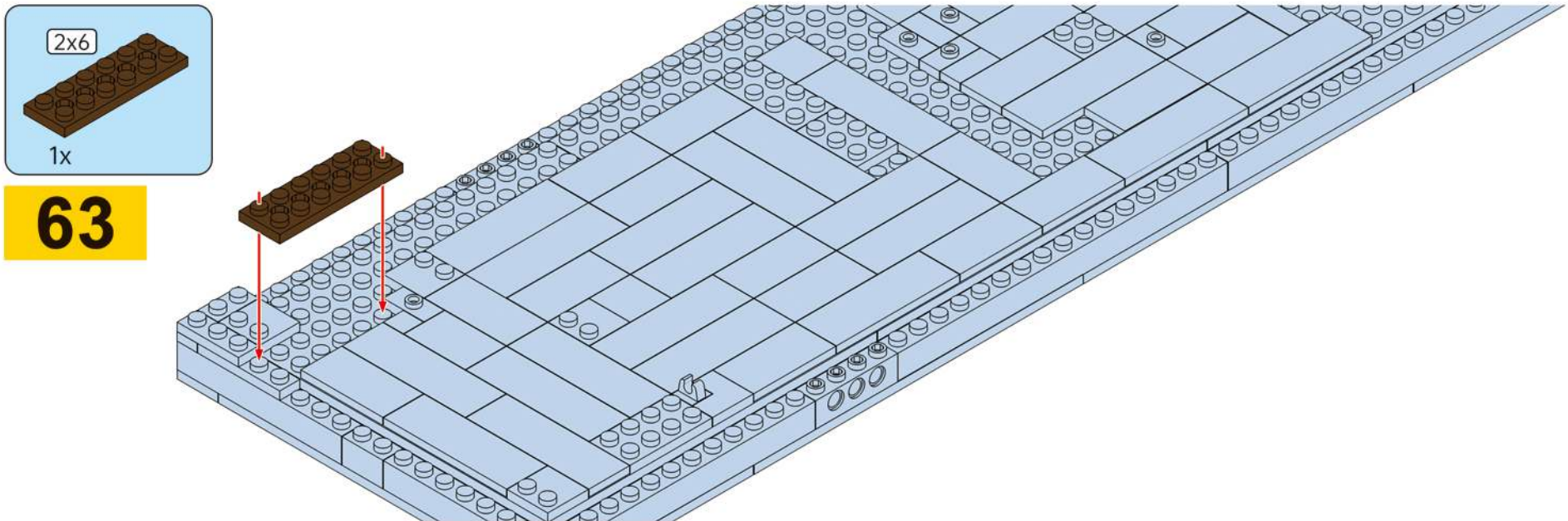
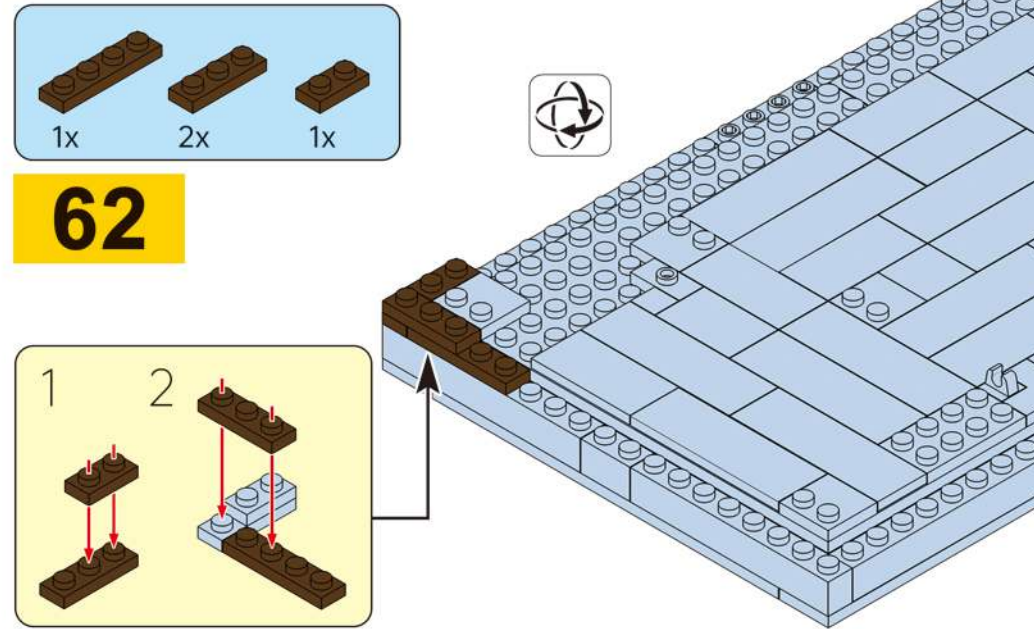
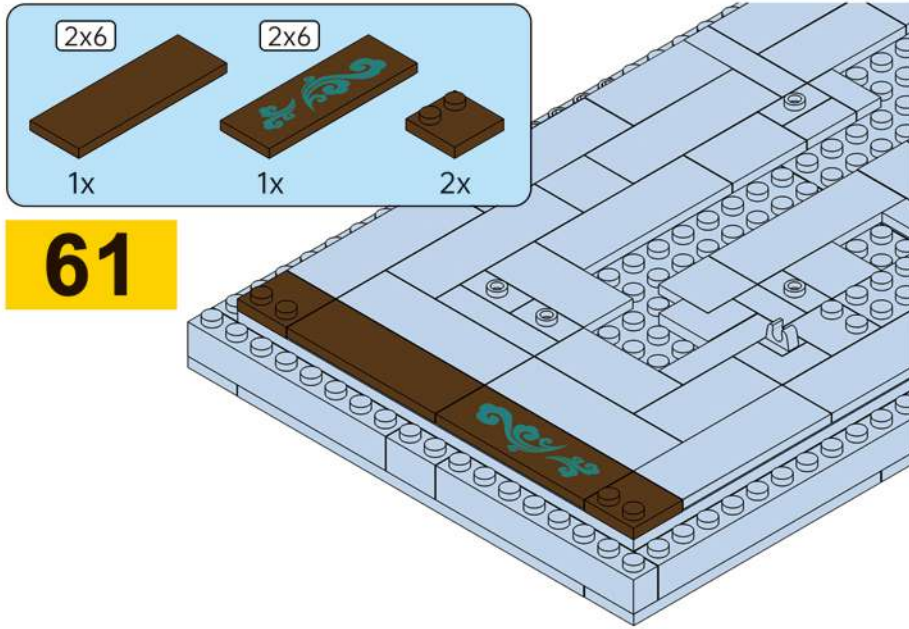

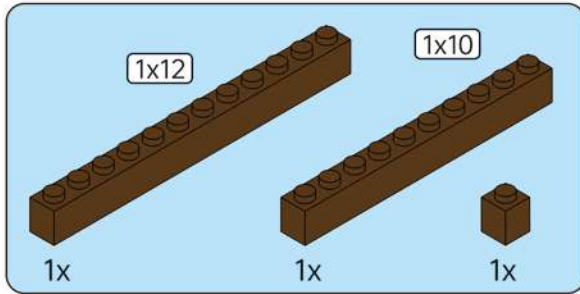

64

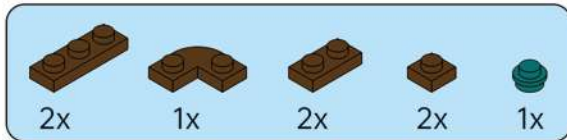
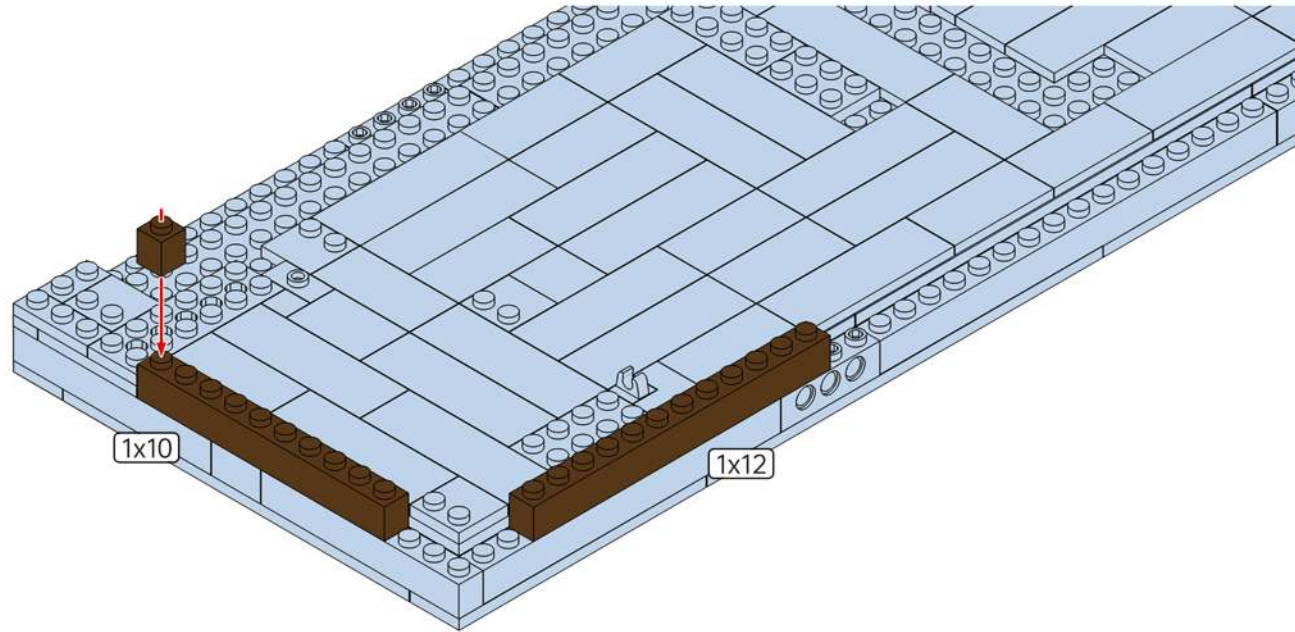

65

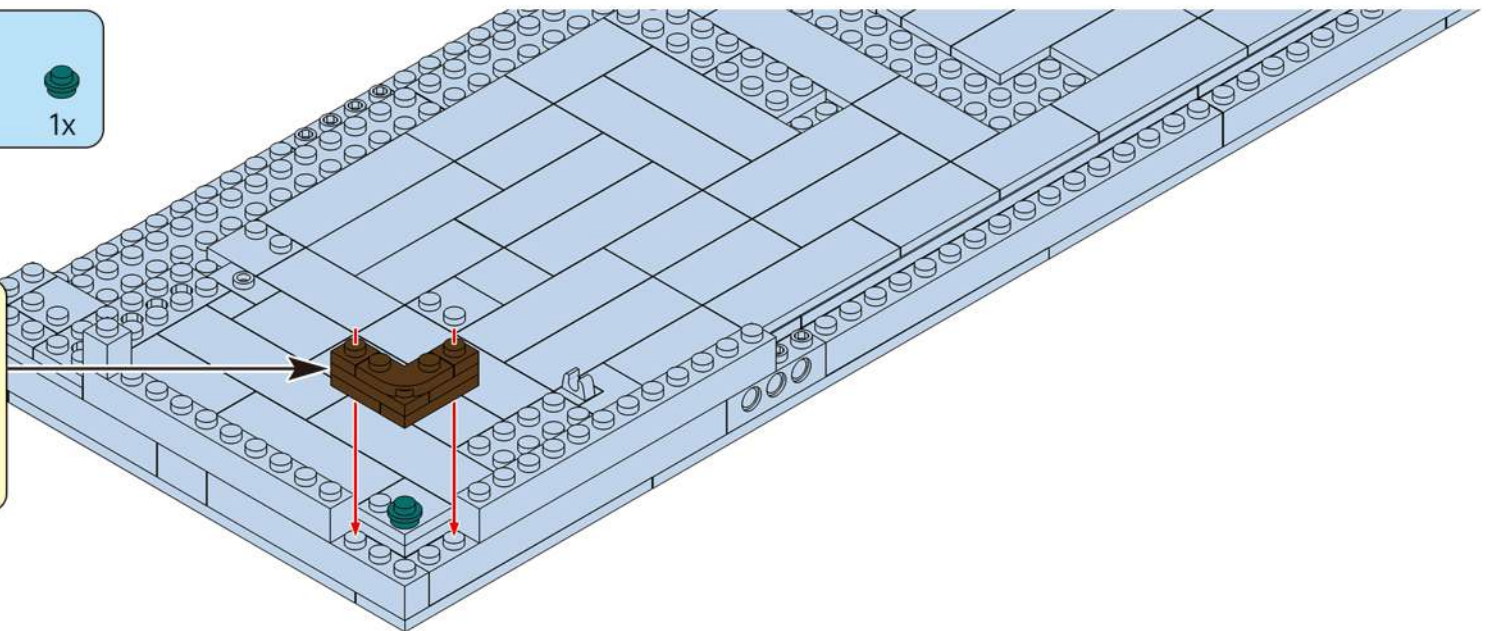
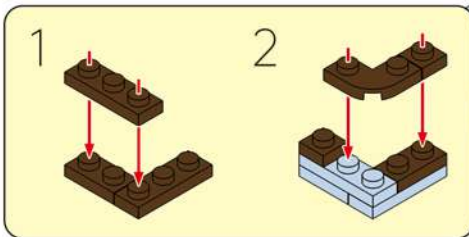

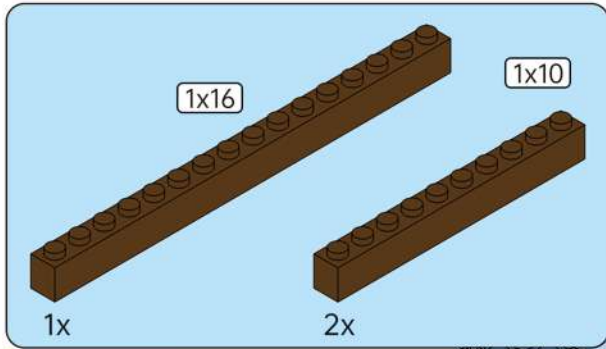

66

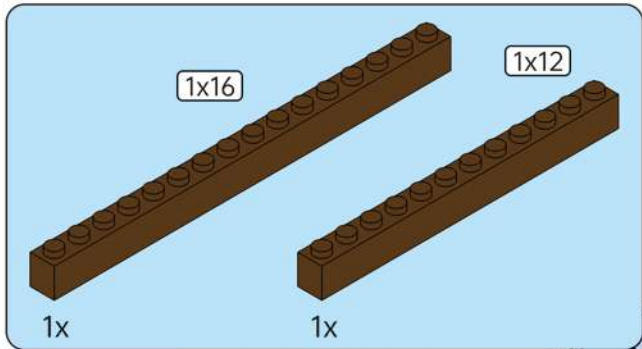
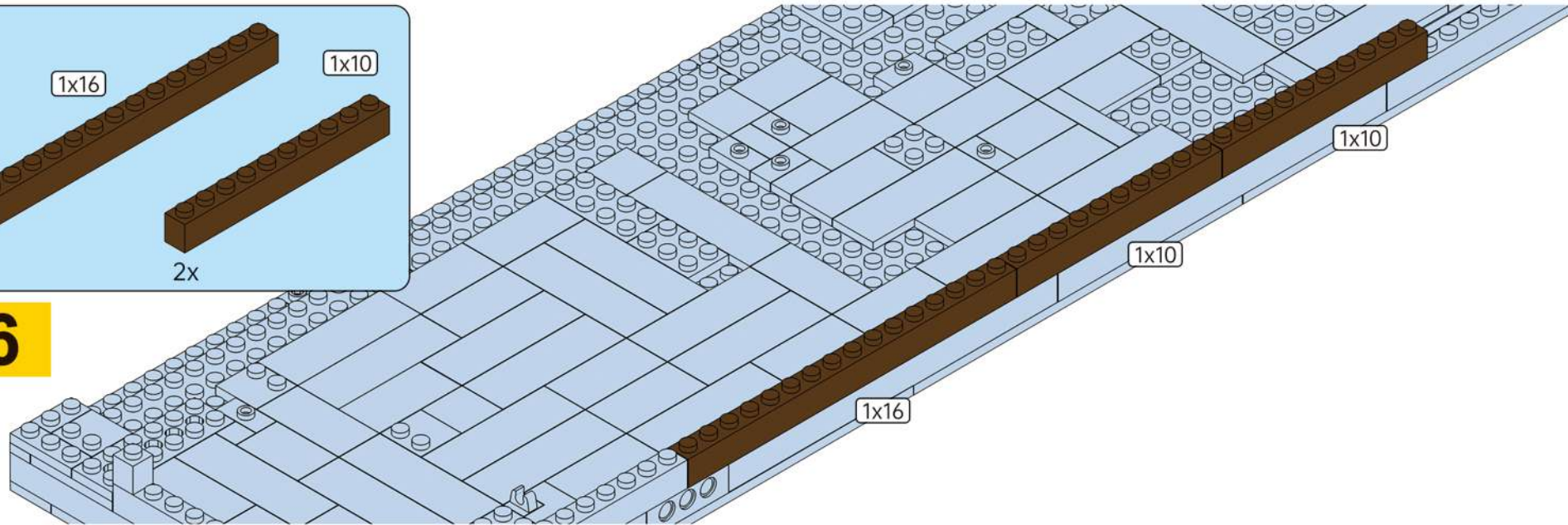

67

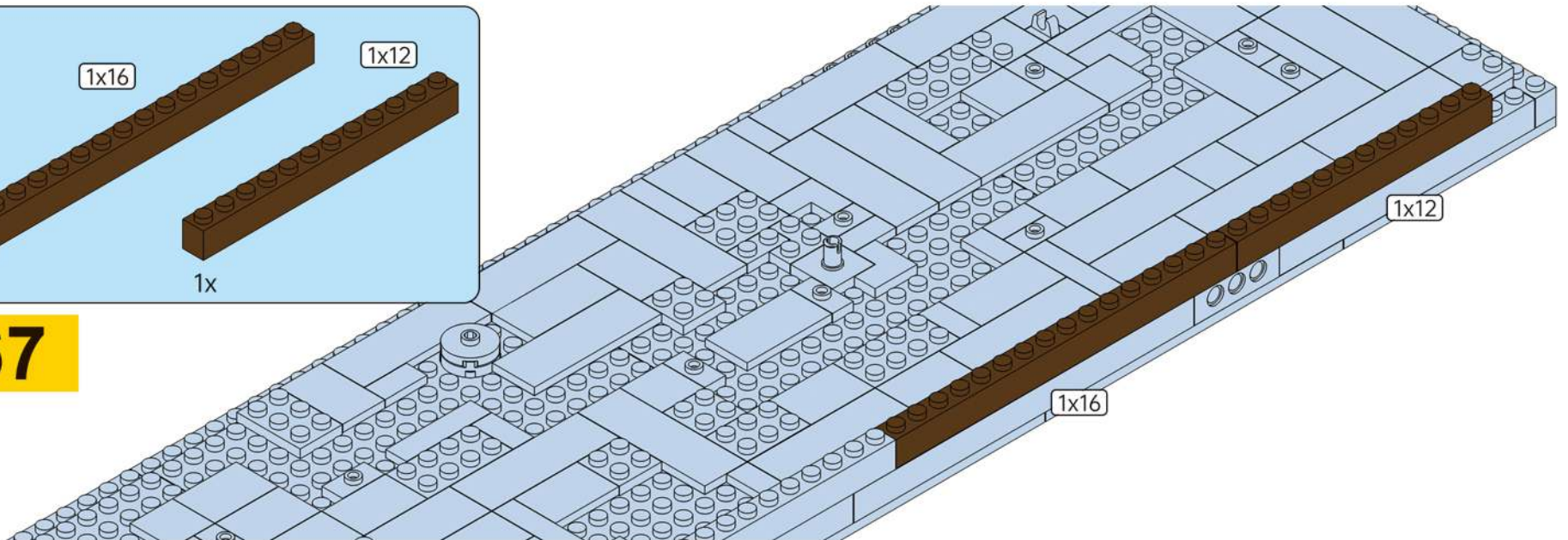

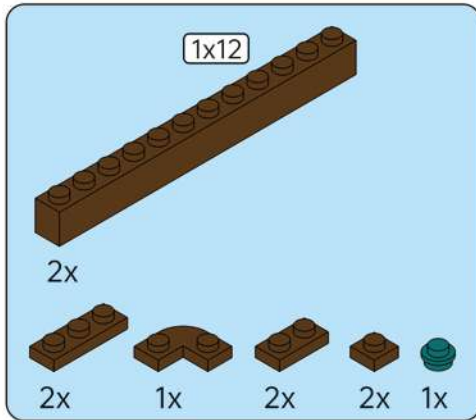

68

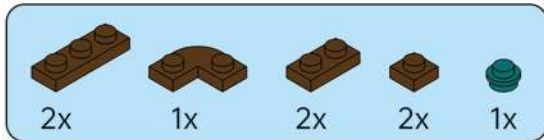
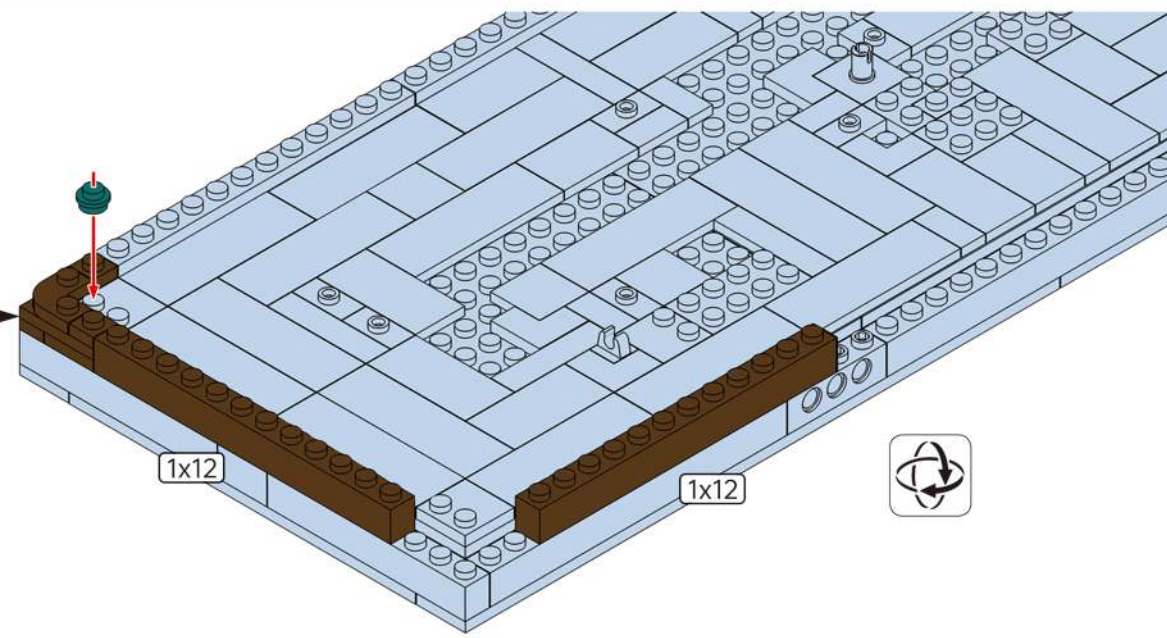
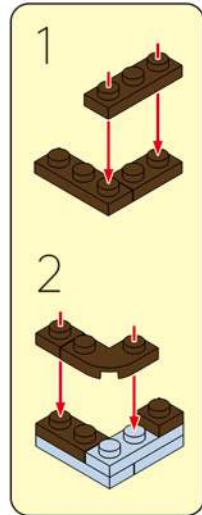

69

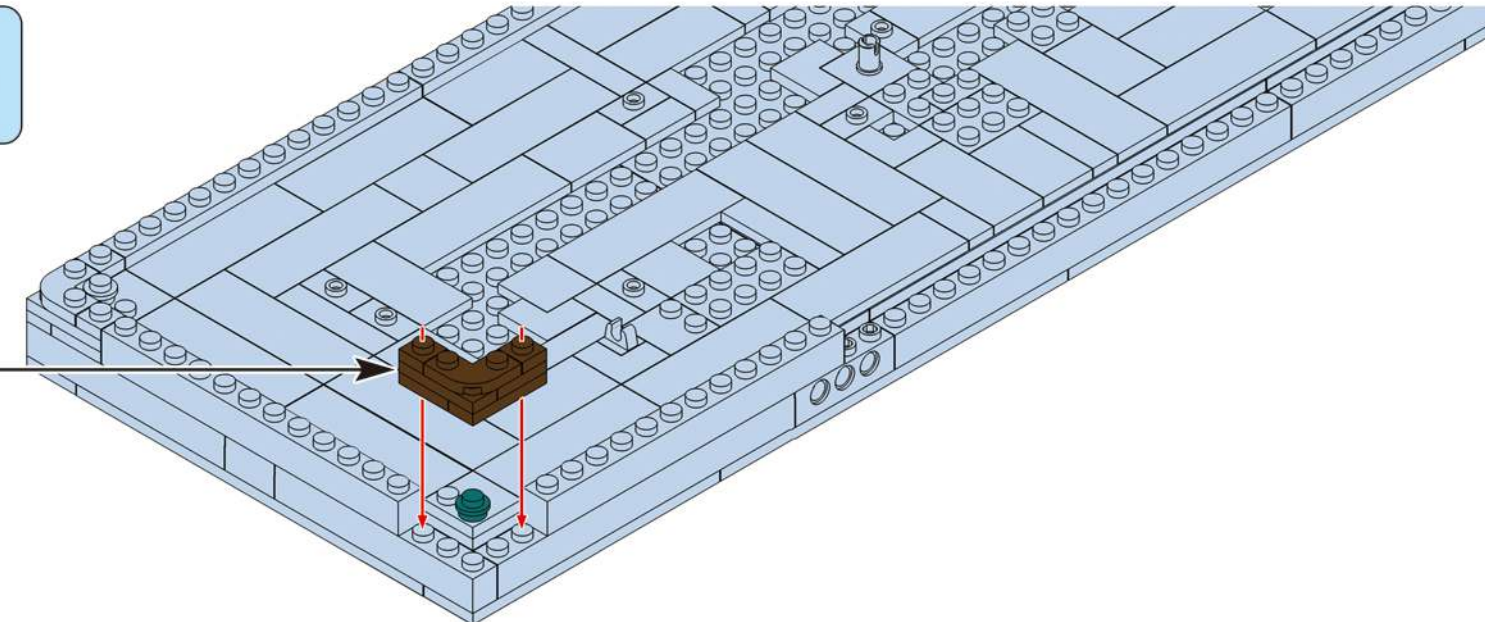
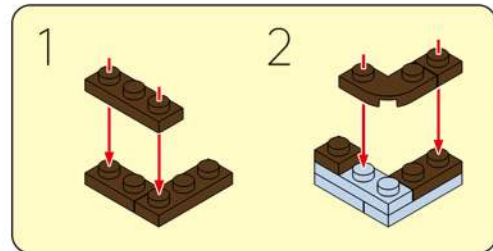

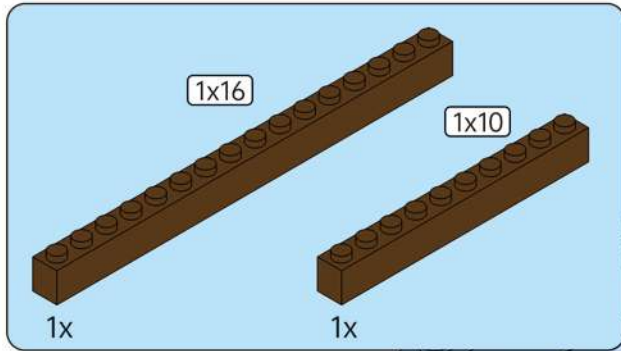

70

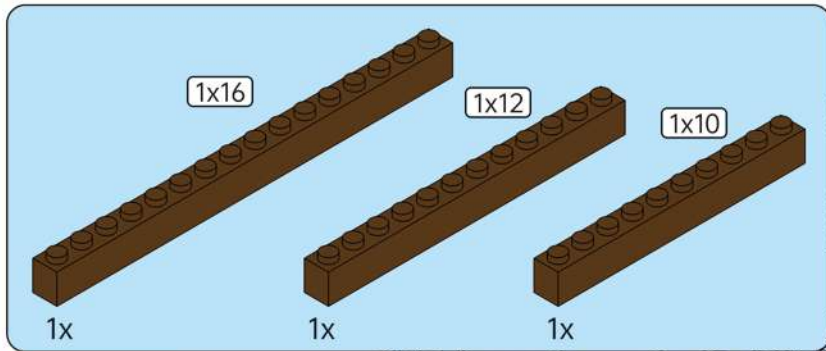
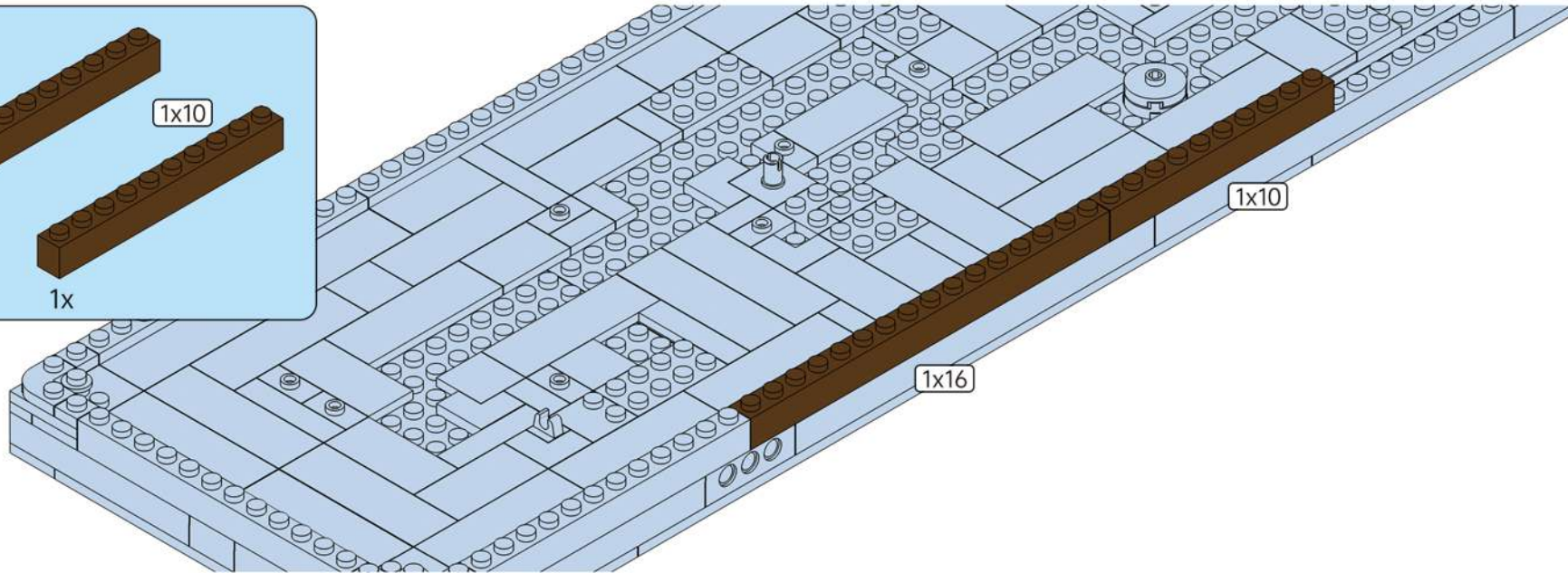

71

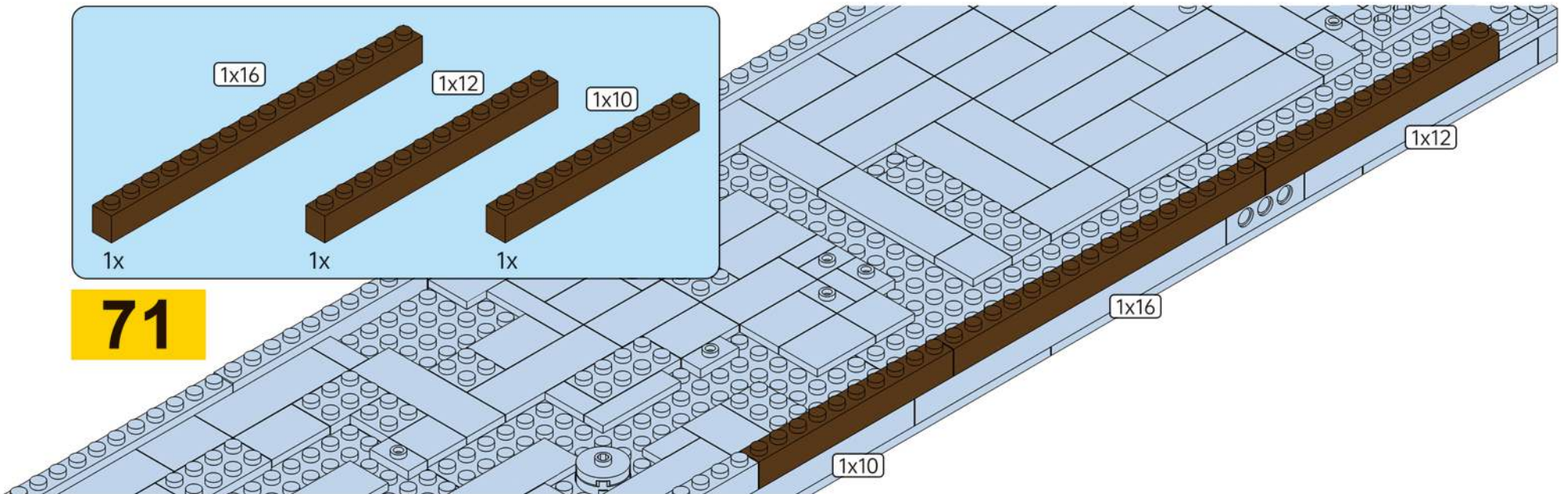

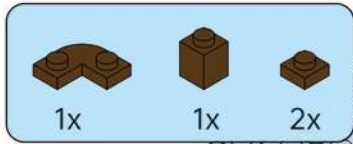

72

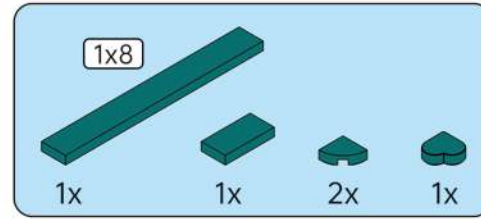
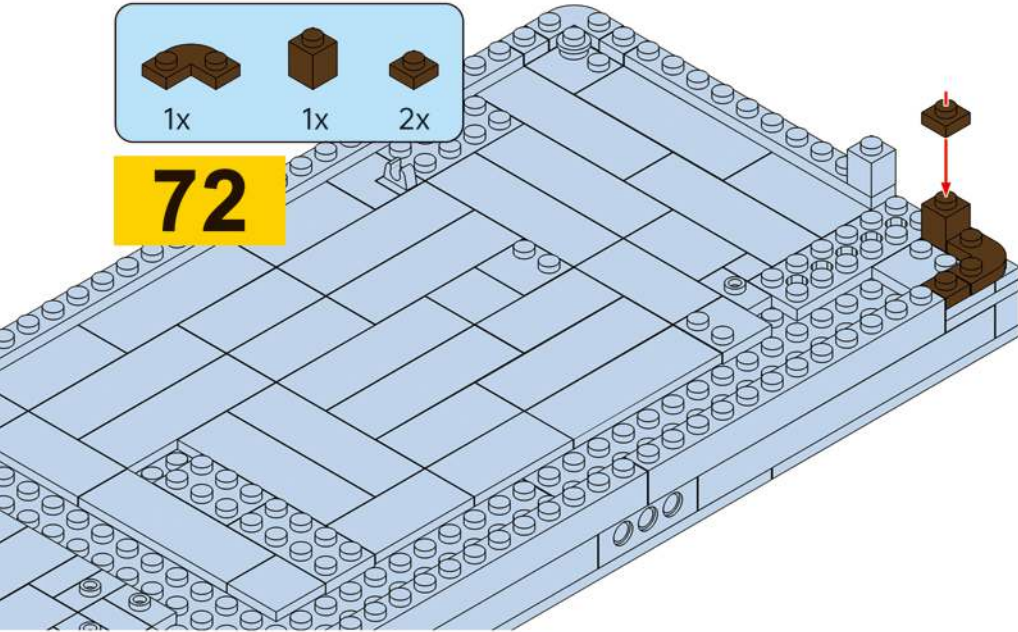

73

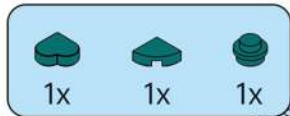
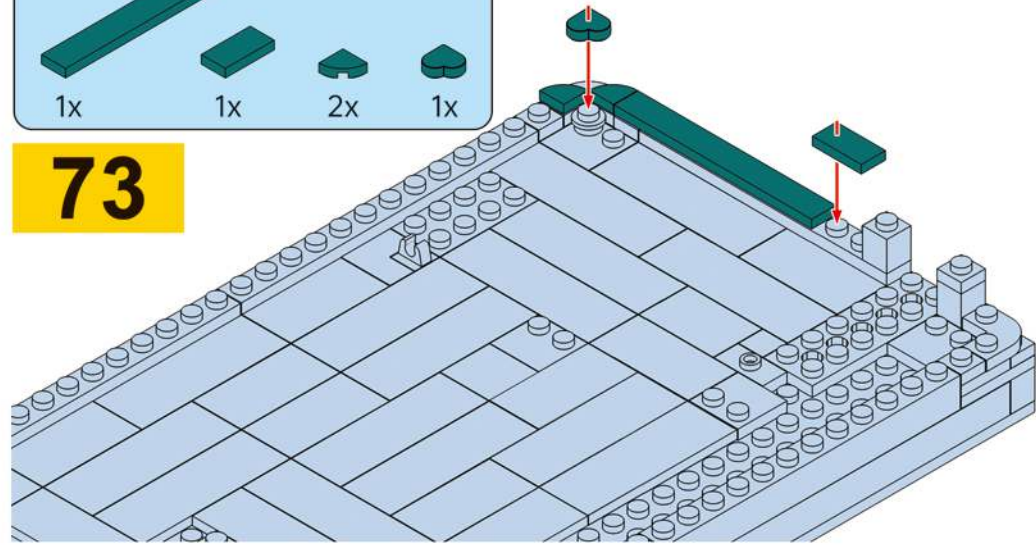

74

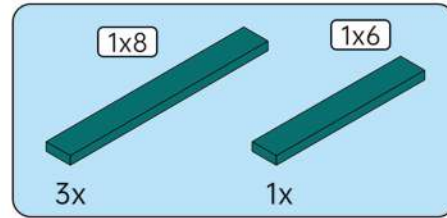
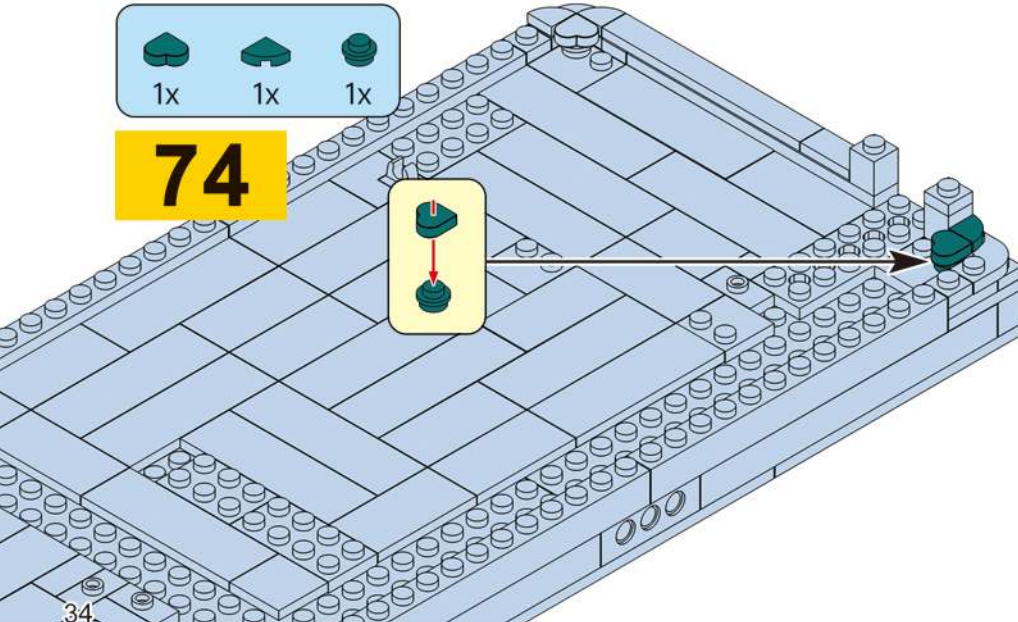

75

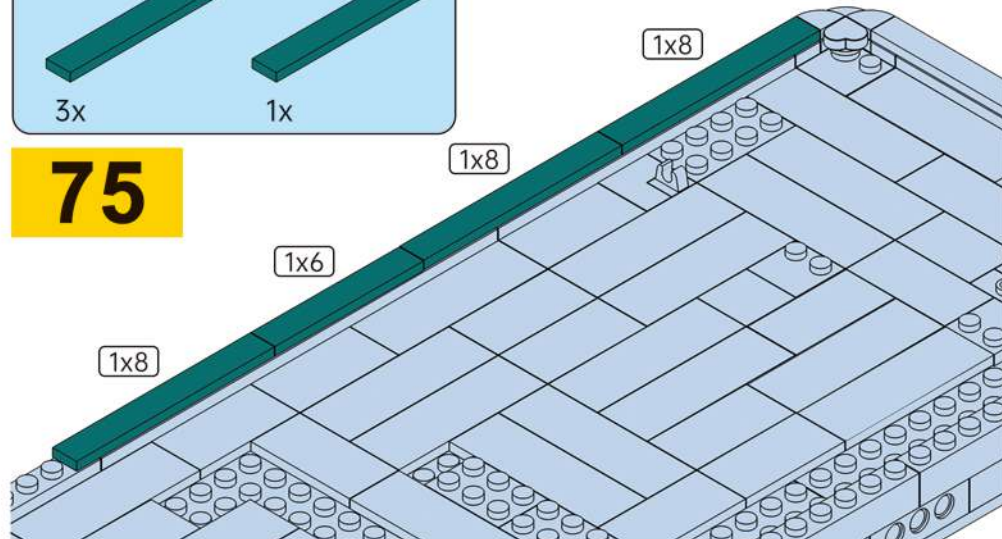

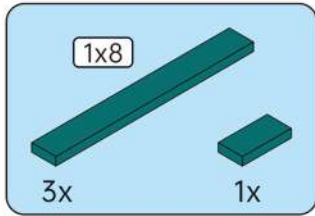

76

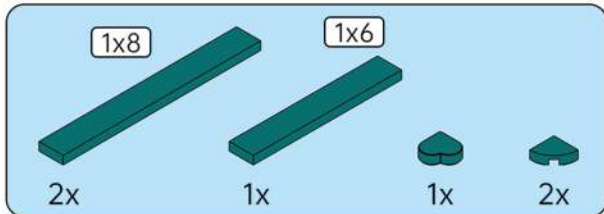
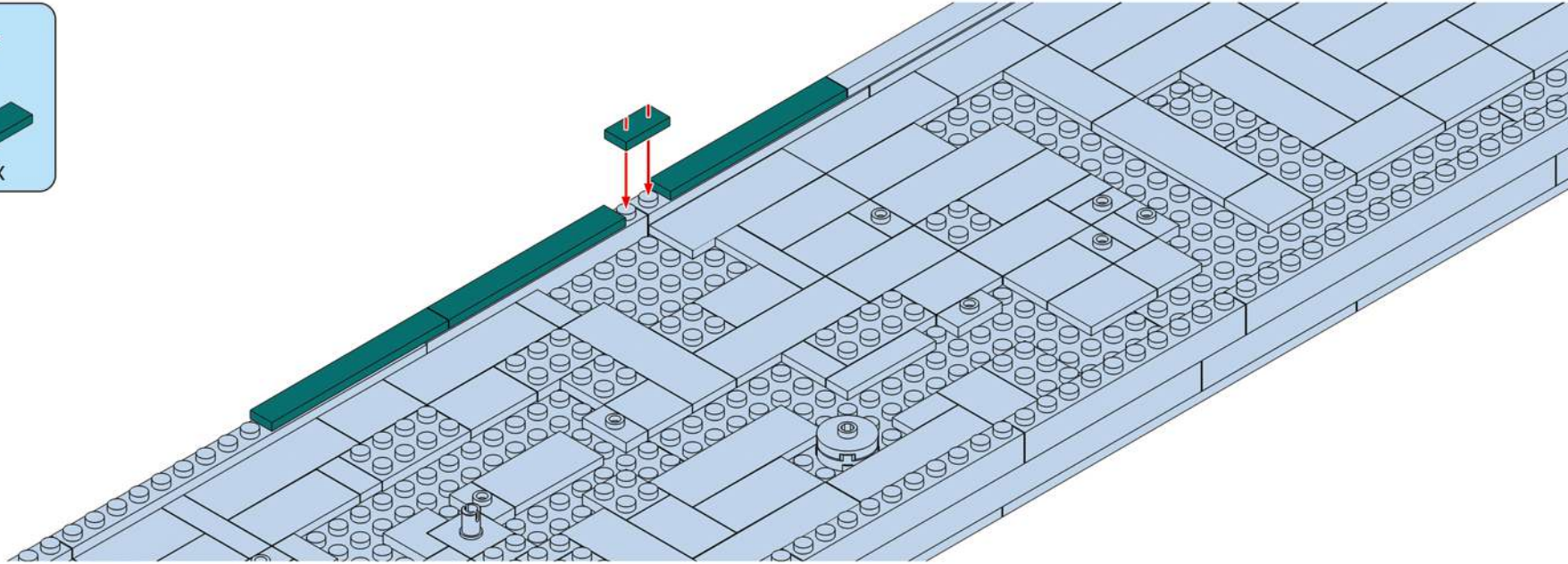

77

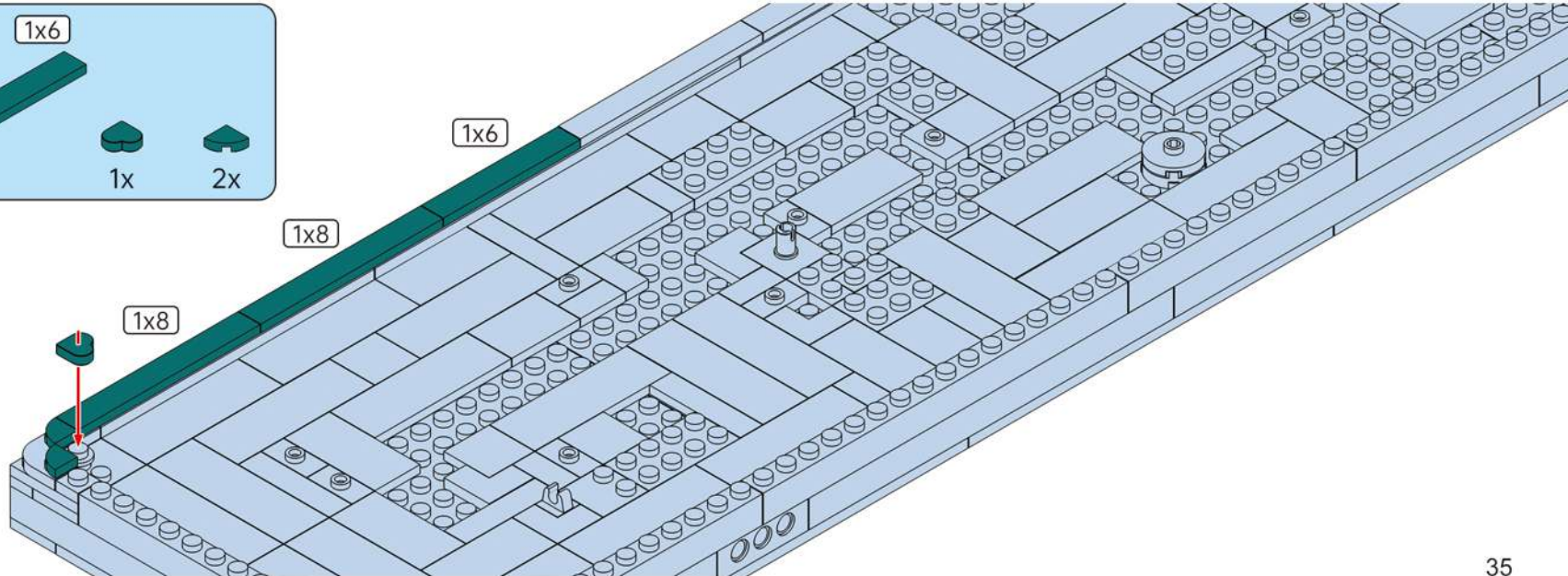

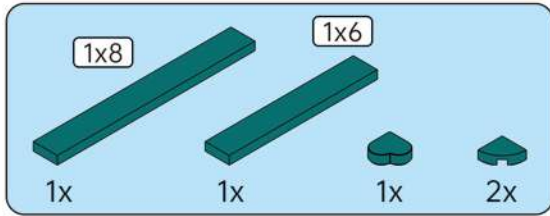

78

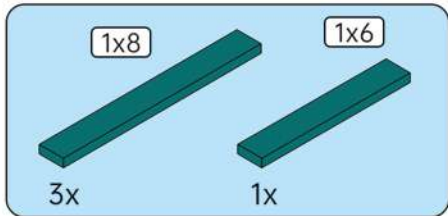
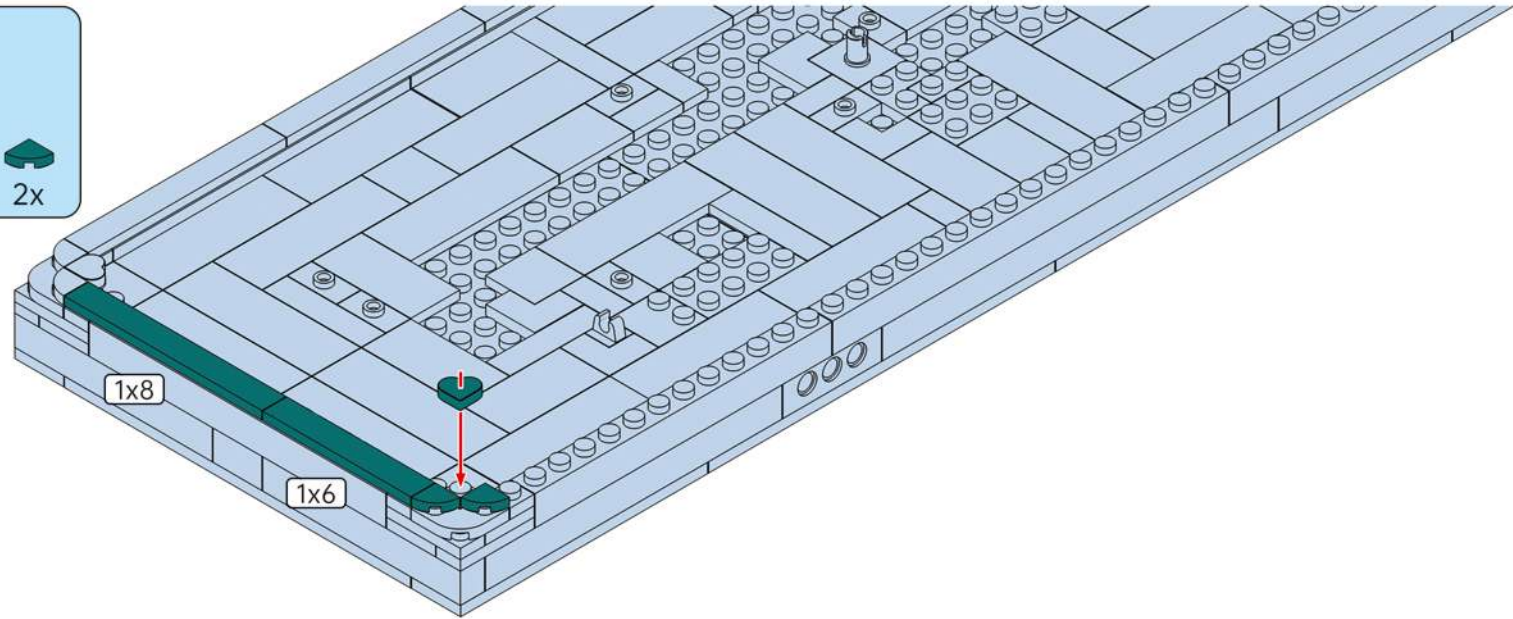

79

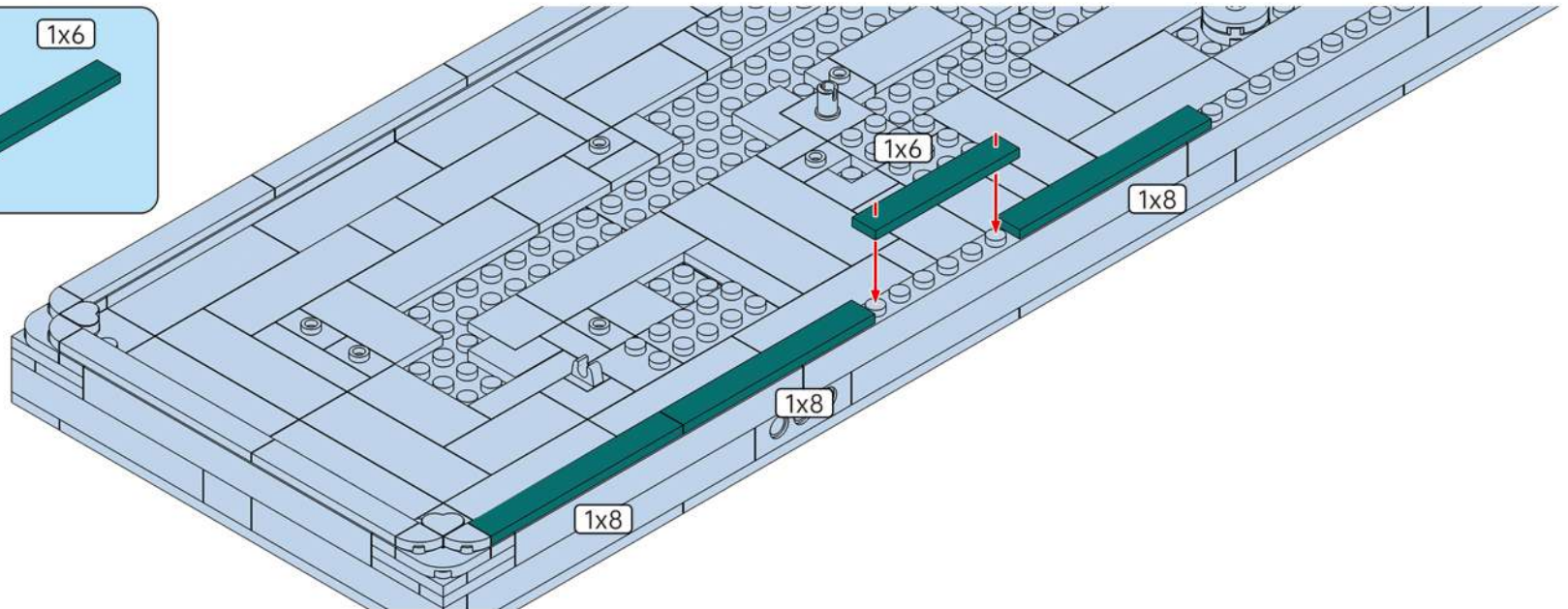

# JOY MAKES BRILLIANCE.

## Embrace Relaxation Embrace Joy

Every adultescent needs a "JOY BOX".  
Please , open your JOY BOX ! Heading for joy.

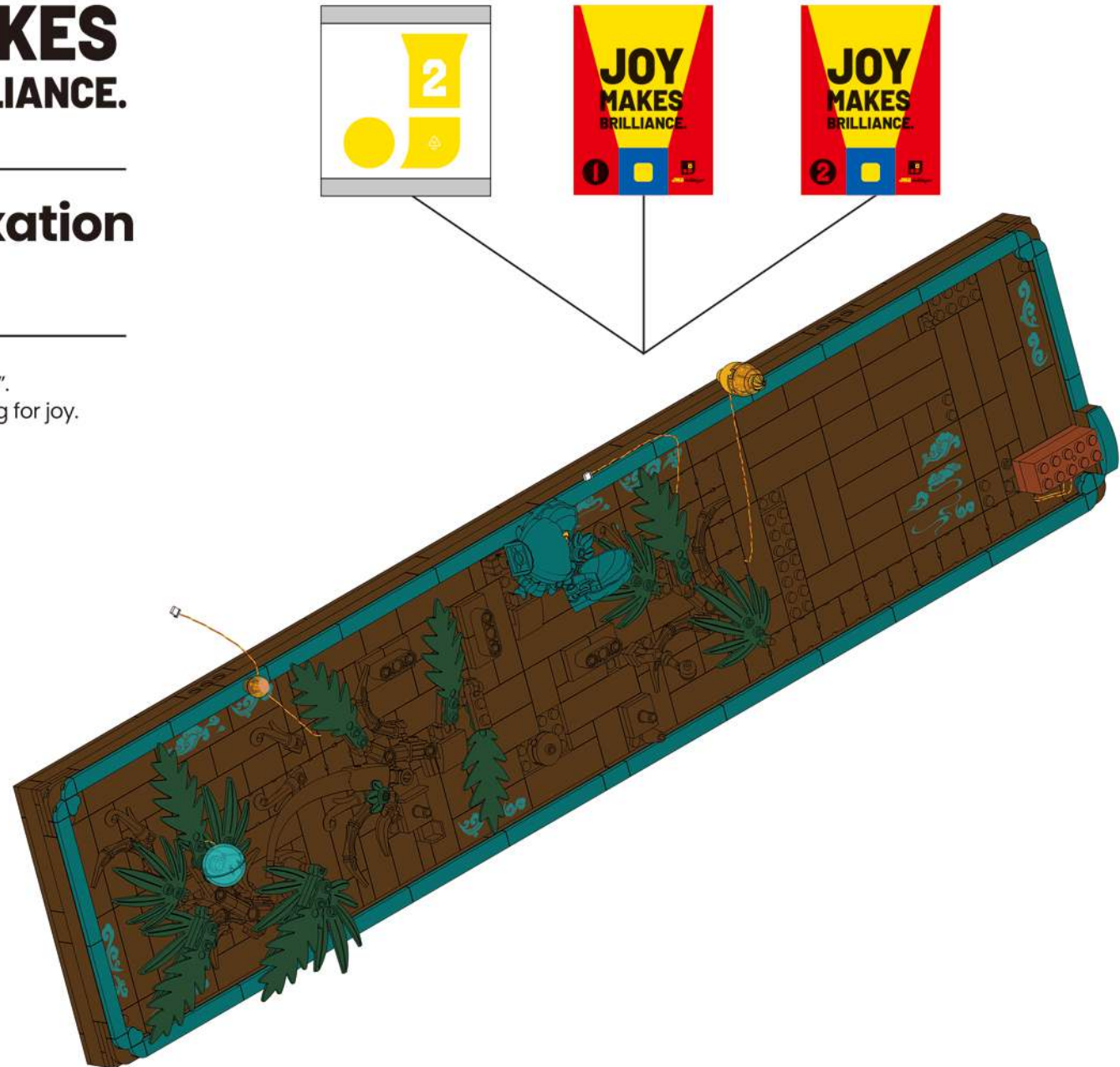

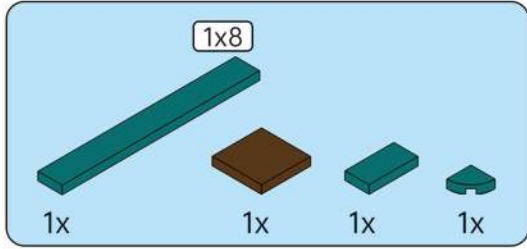

80

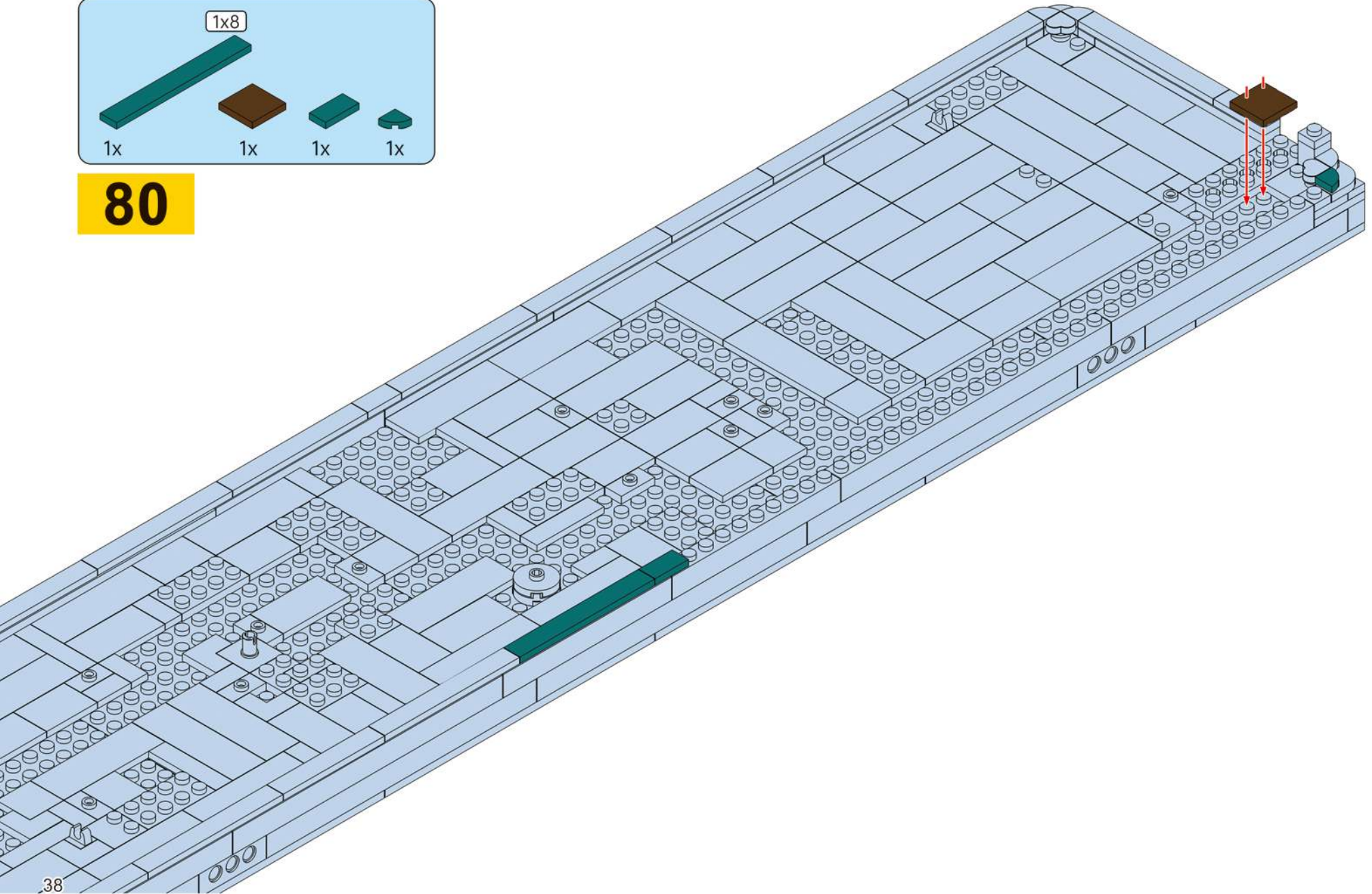

 1x

40cm/15.75in

 4x

81

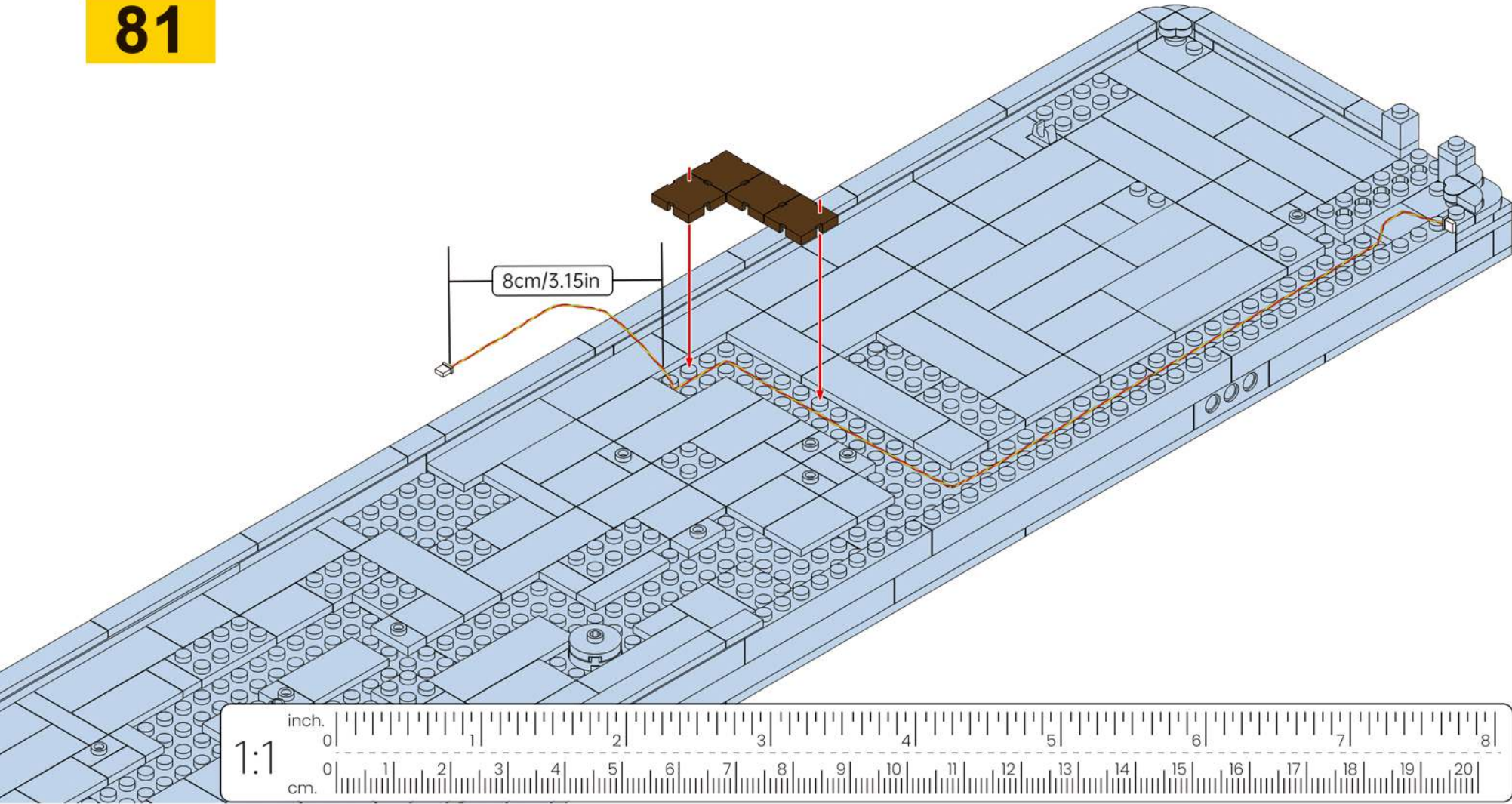



1x



2x



1x



1x

82



This component will be assembled in the subsequent steps.

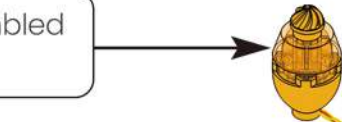

8cm/3.15in

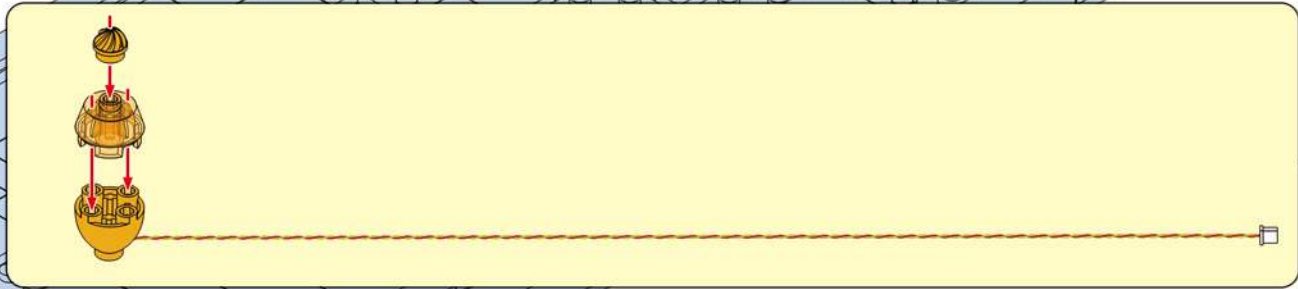
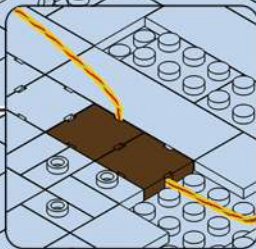

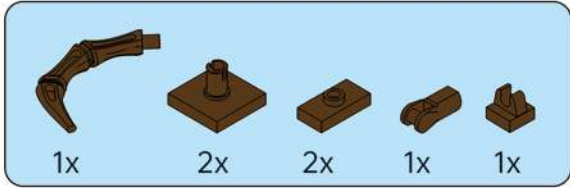

83

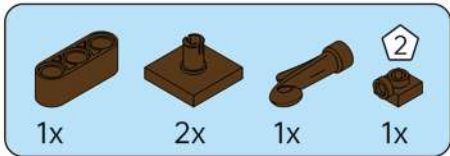
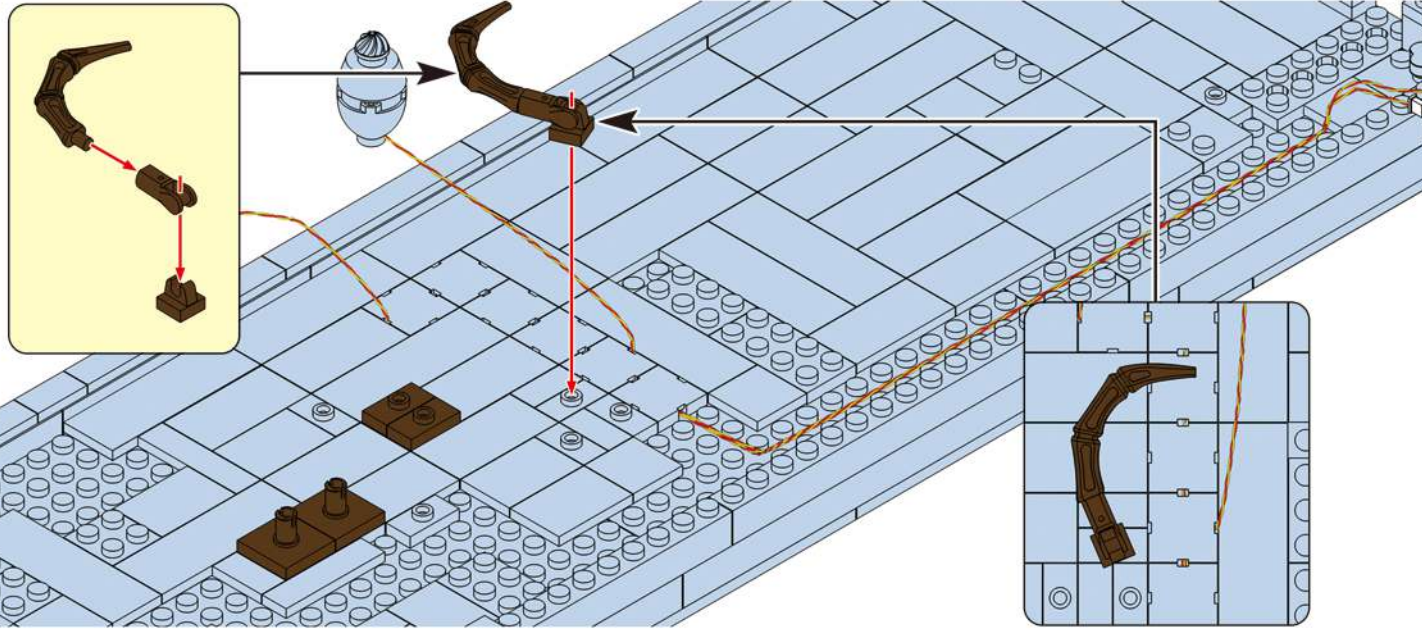

84

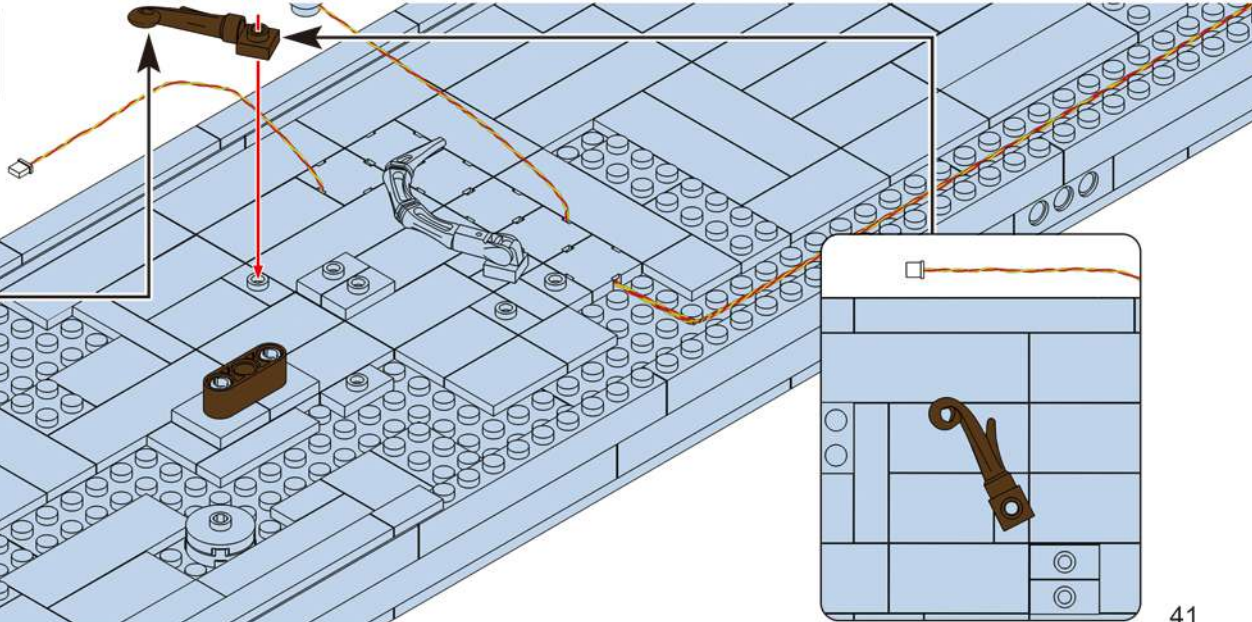
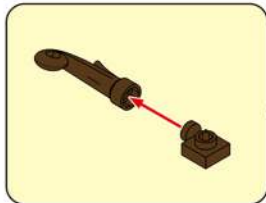
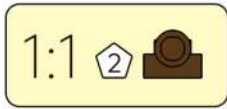

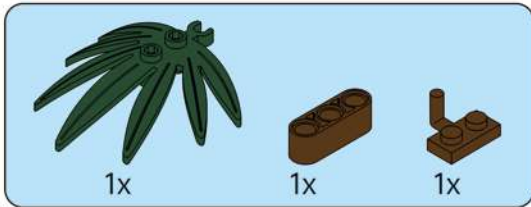

85

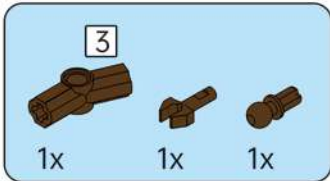
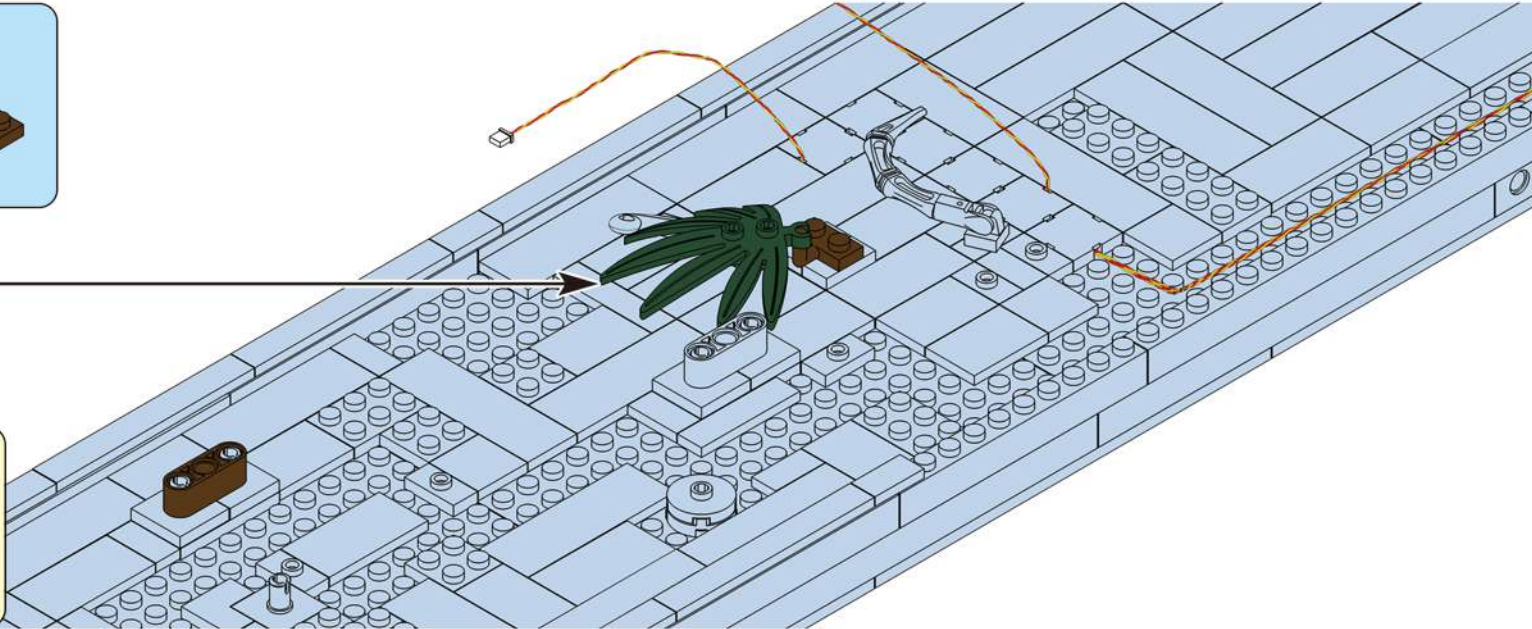
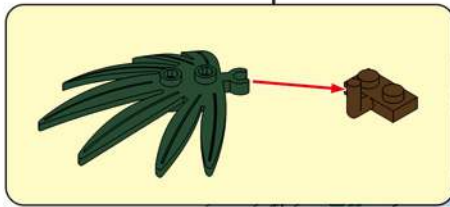

86

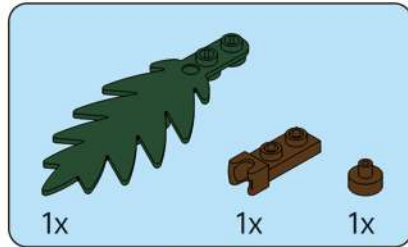
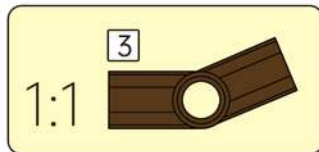

87

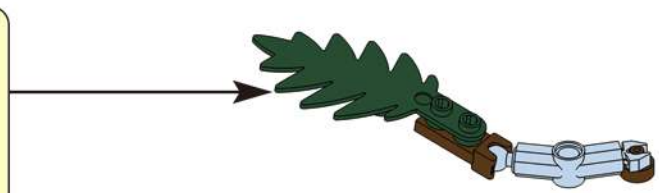
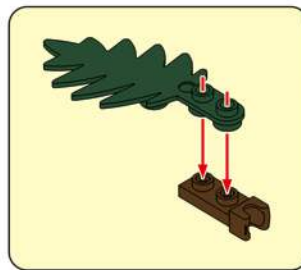

**88**

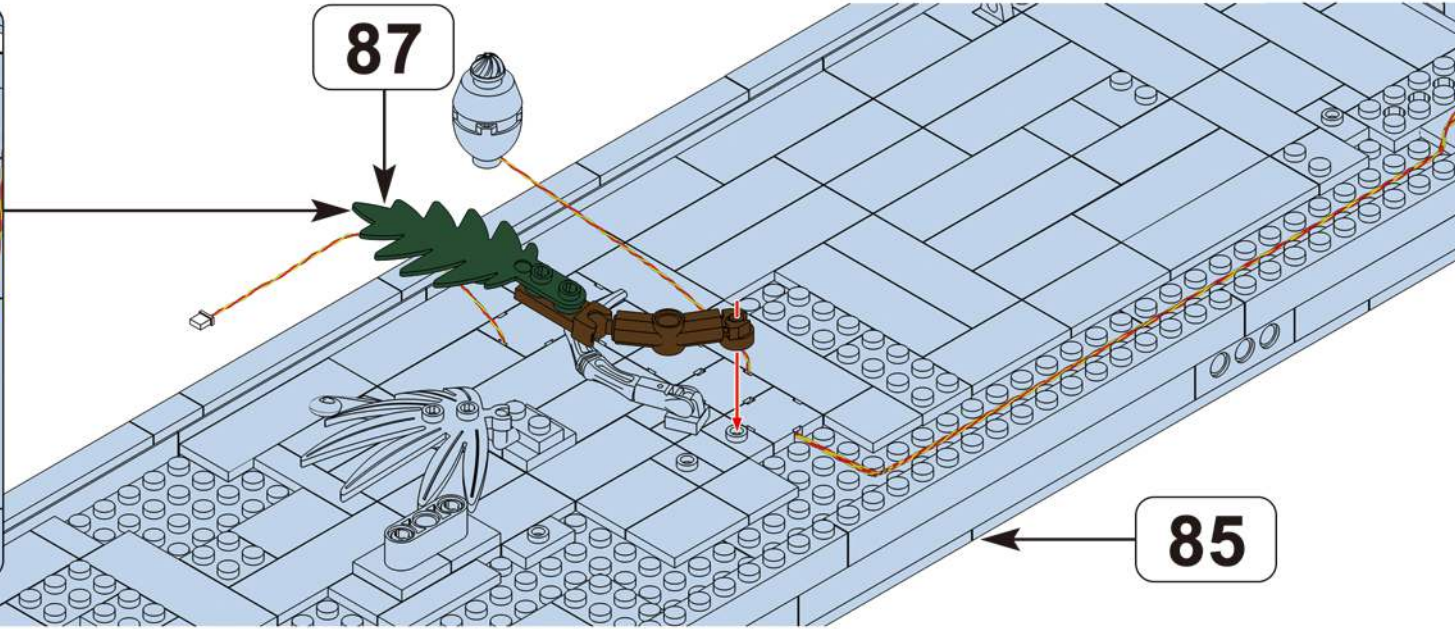
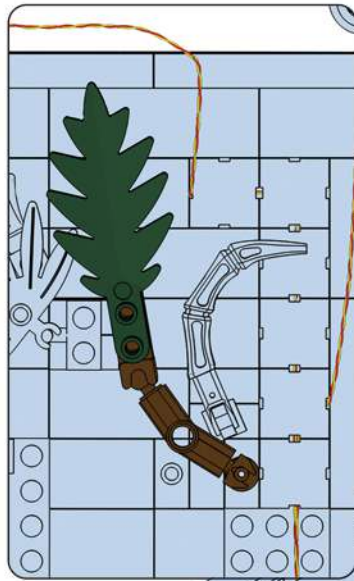

**87**

**85**

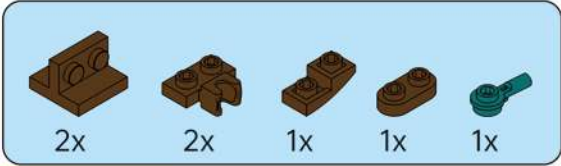

**89**

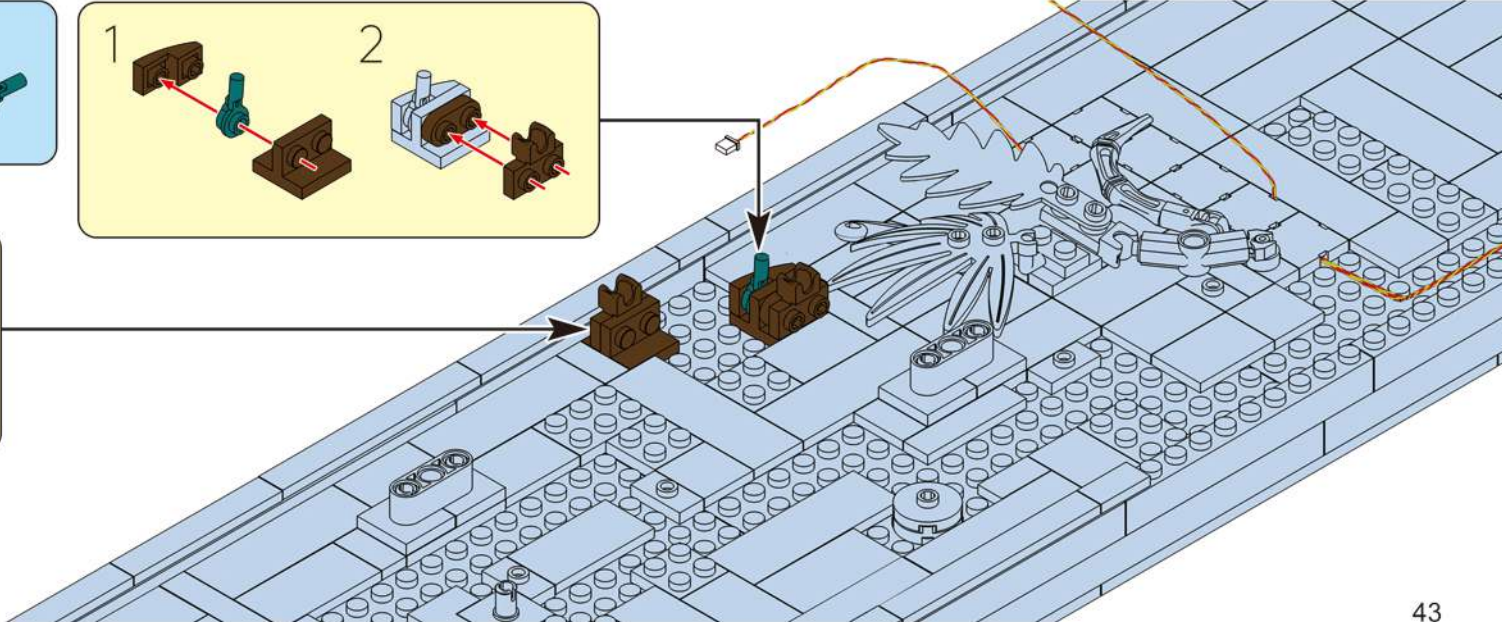
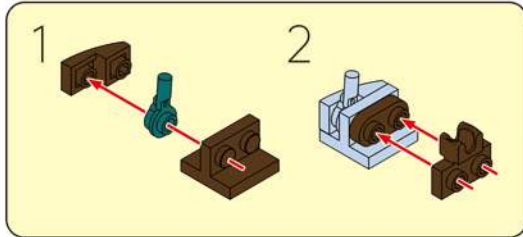
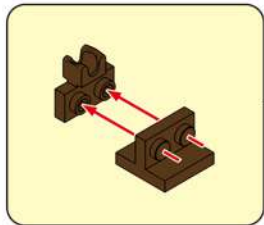

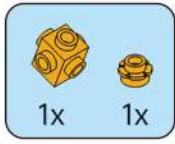

**90**



**91**

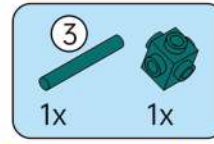
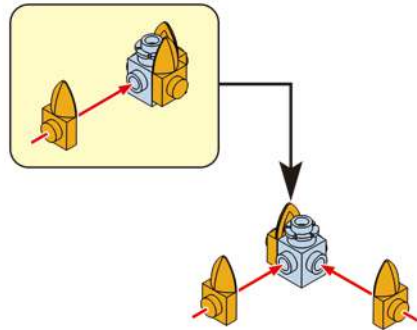

**92**

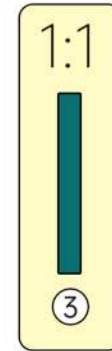
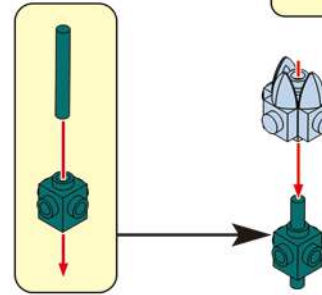

**93**

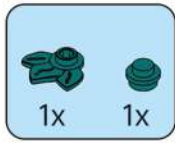
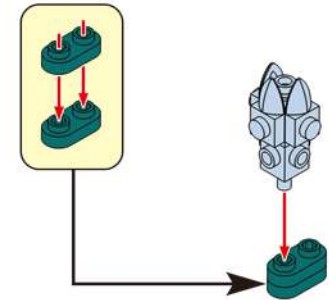

**94**

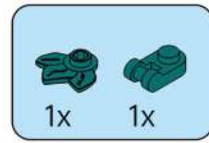
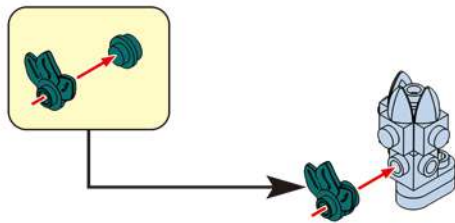

**95**

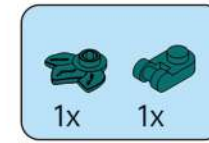
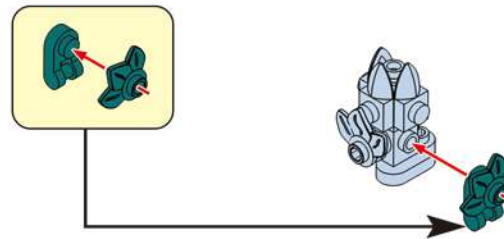

**96**

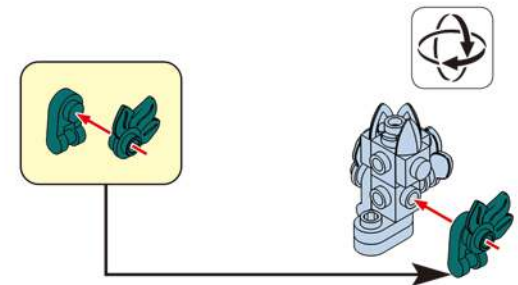

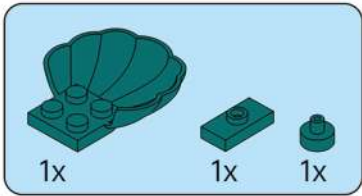

97

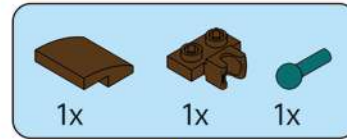
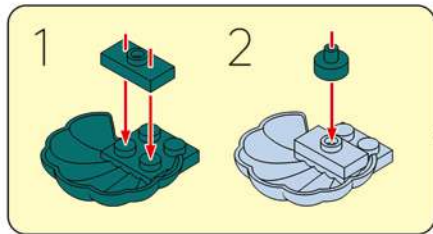

98

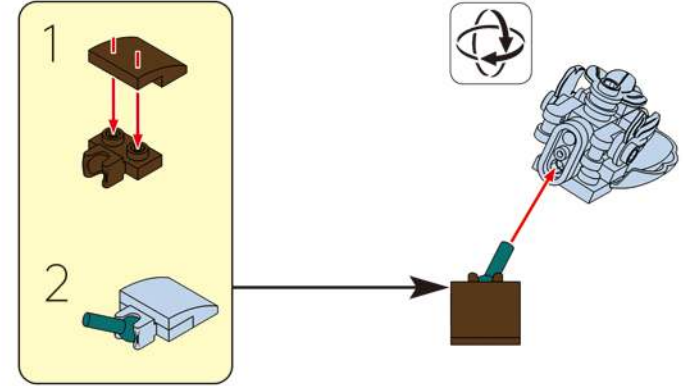

99

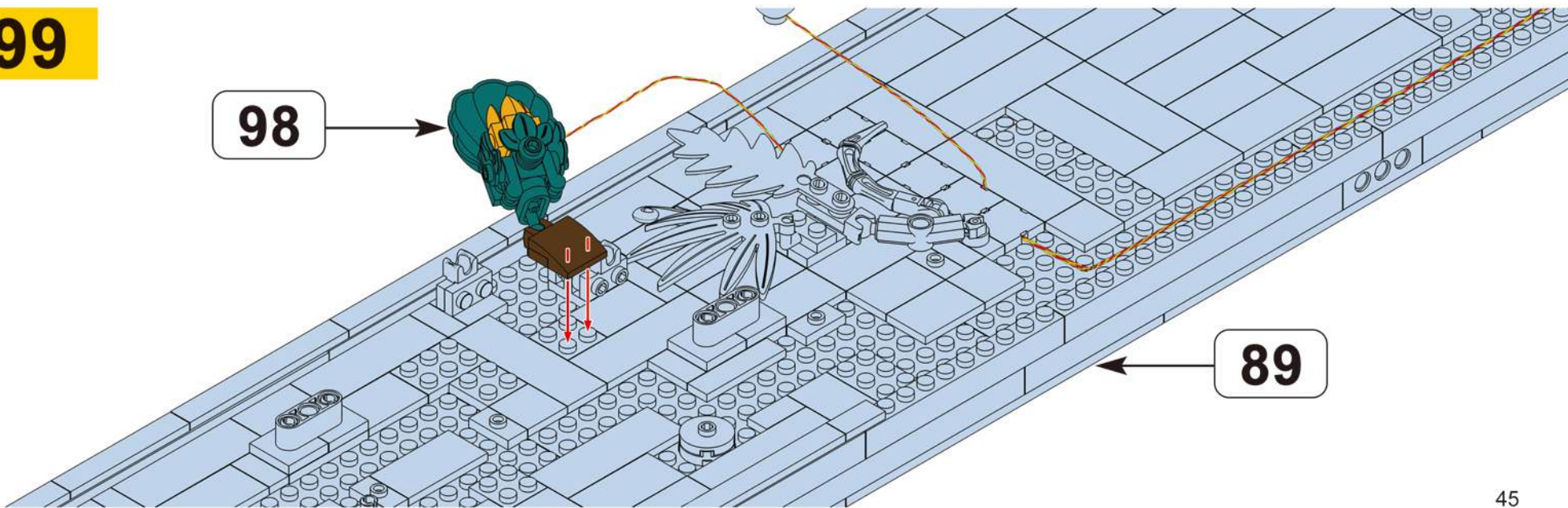

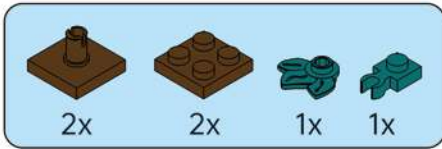

100

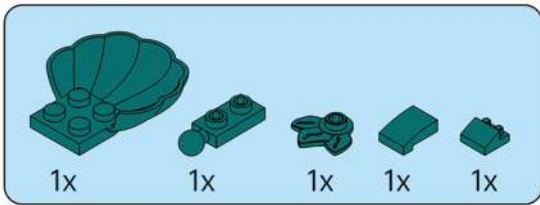
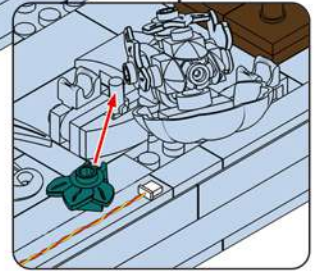
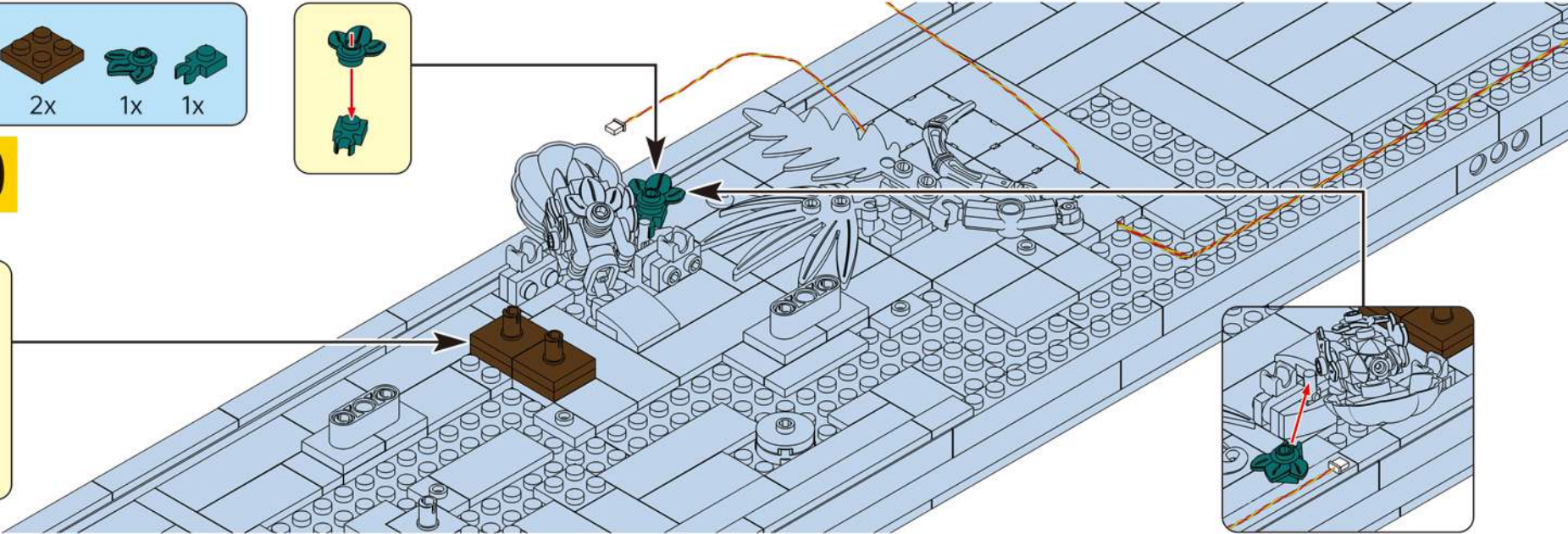
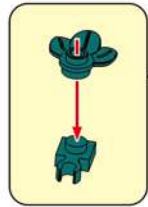
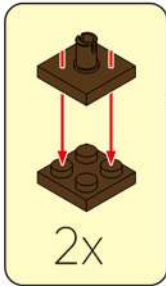

101

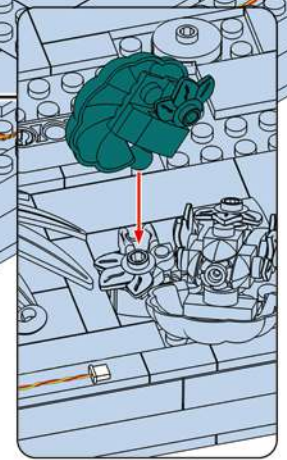
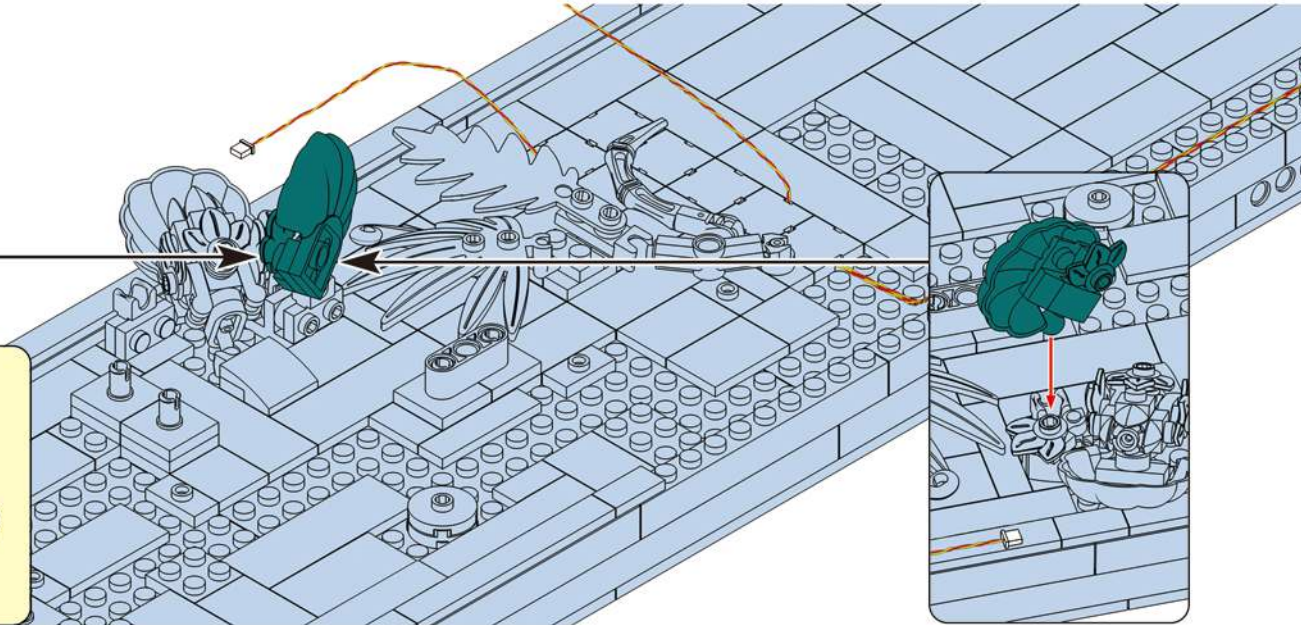
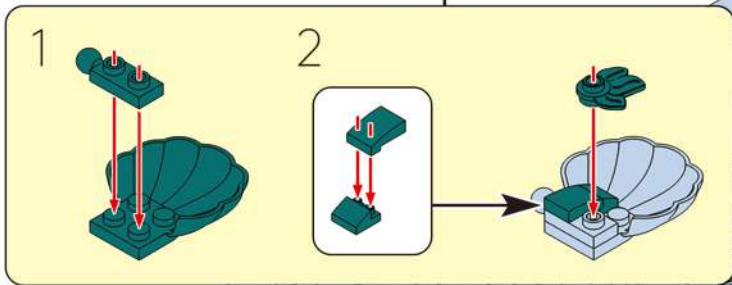

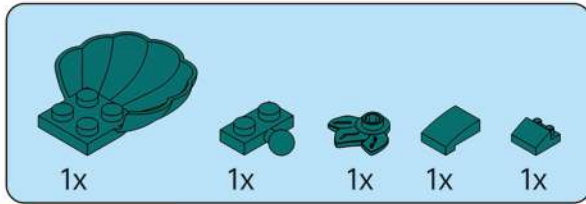

102

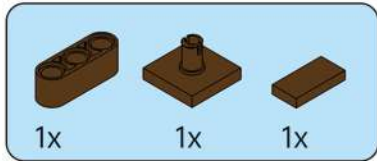
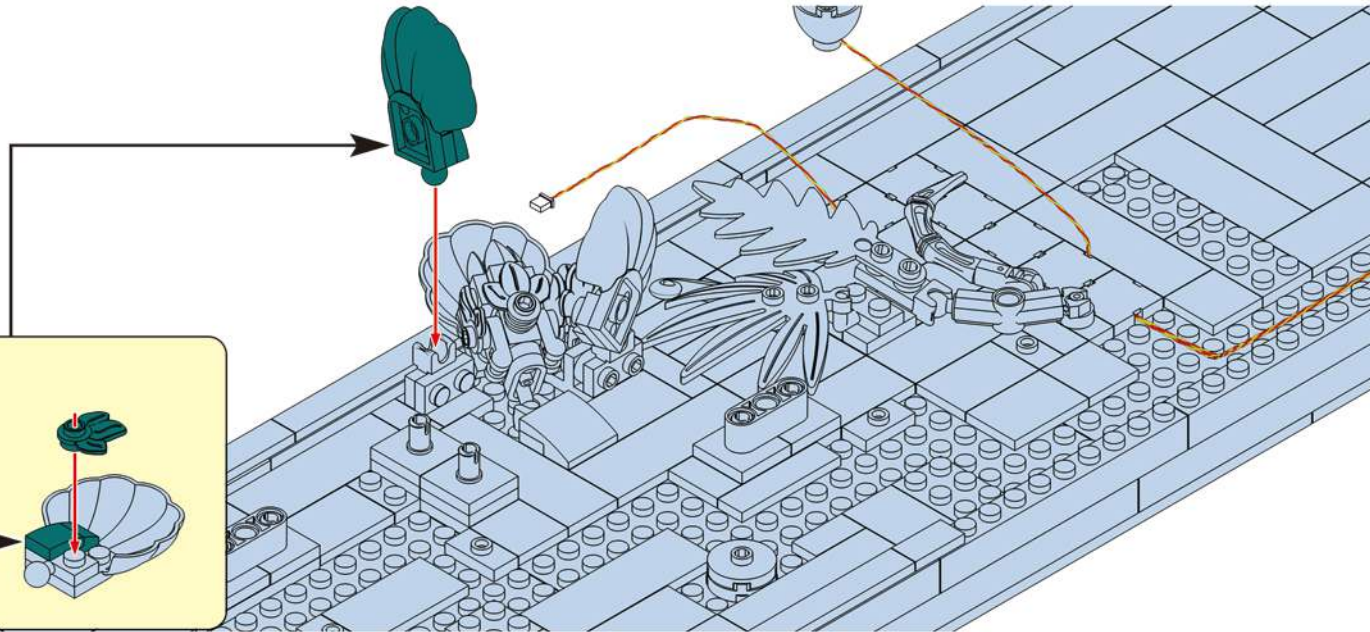
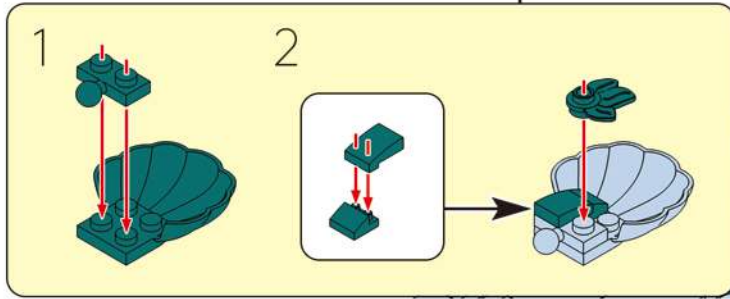

103

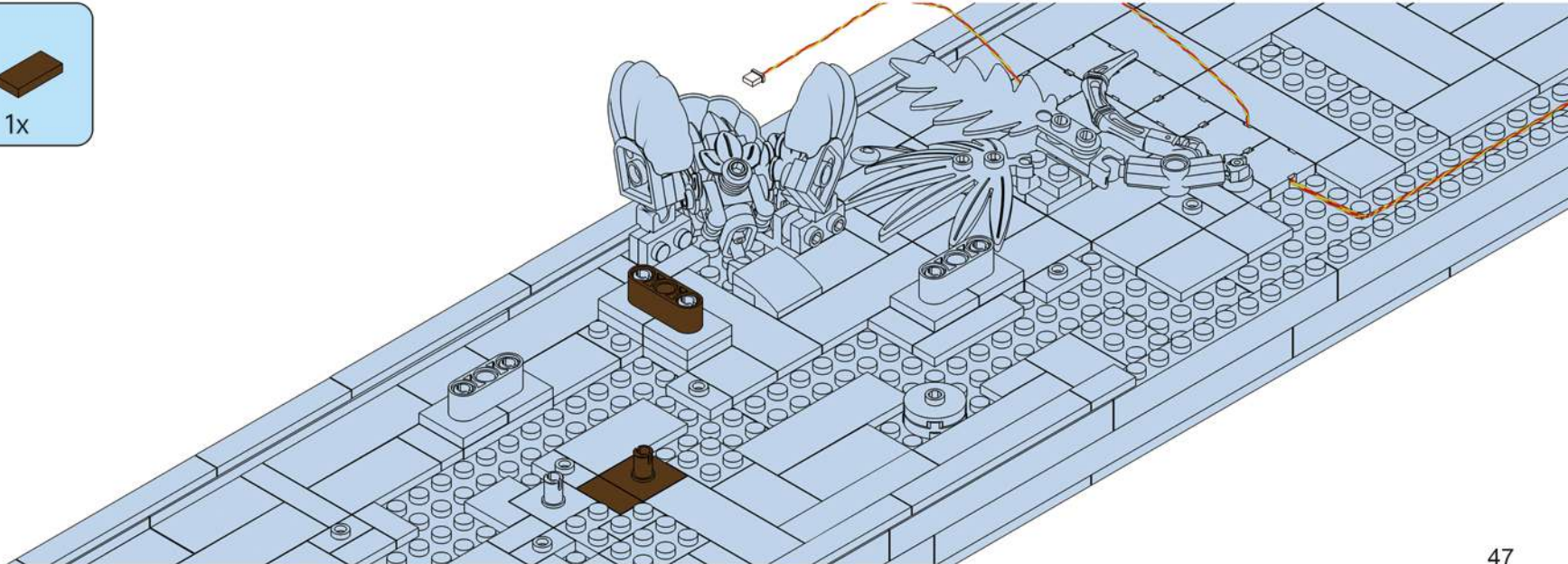

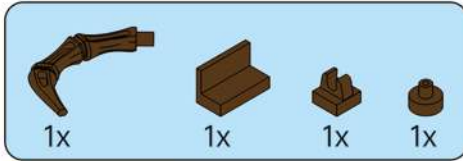

# 104

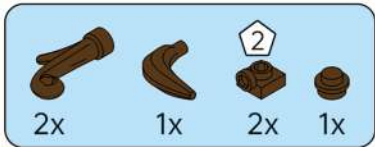
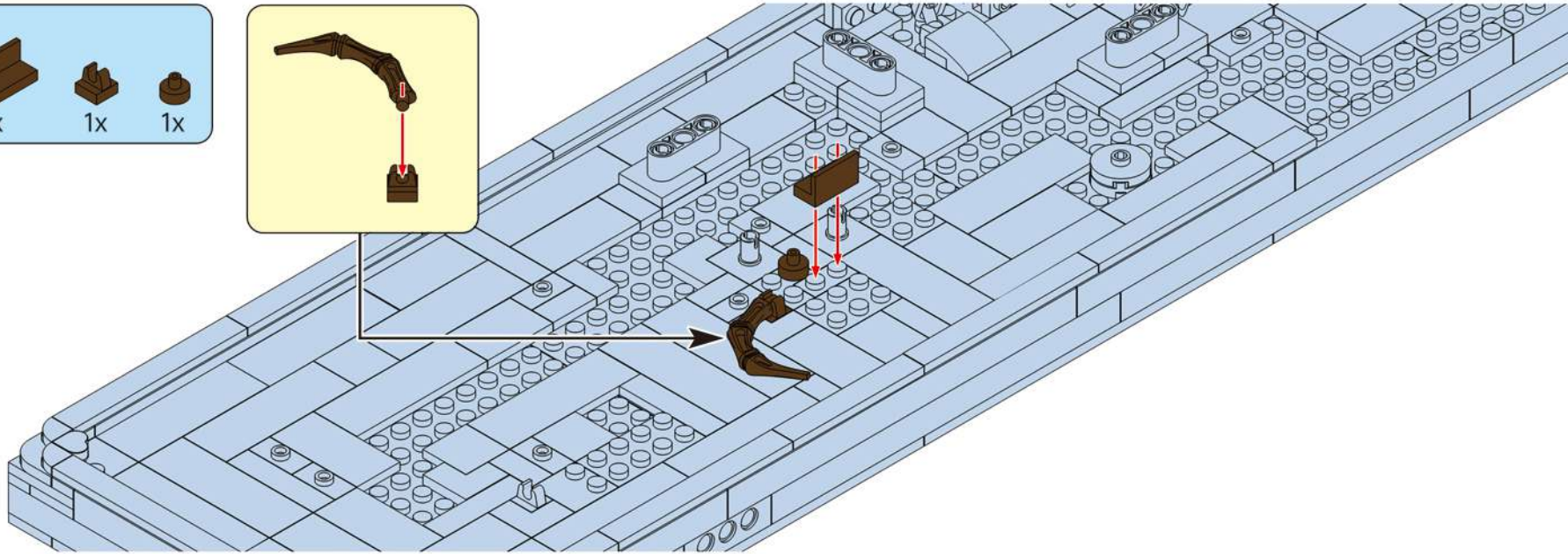
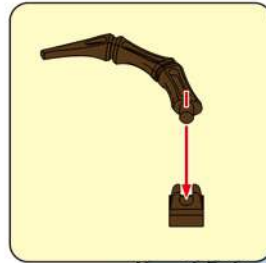

# 105

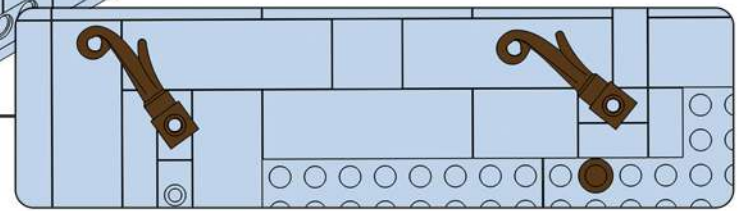
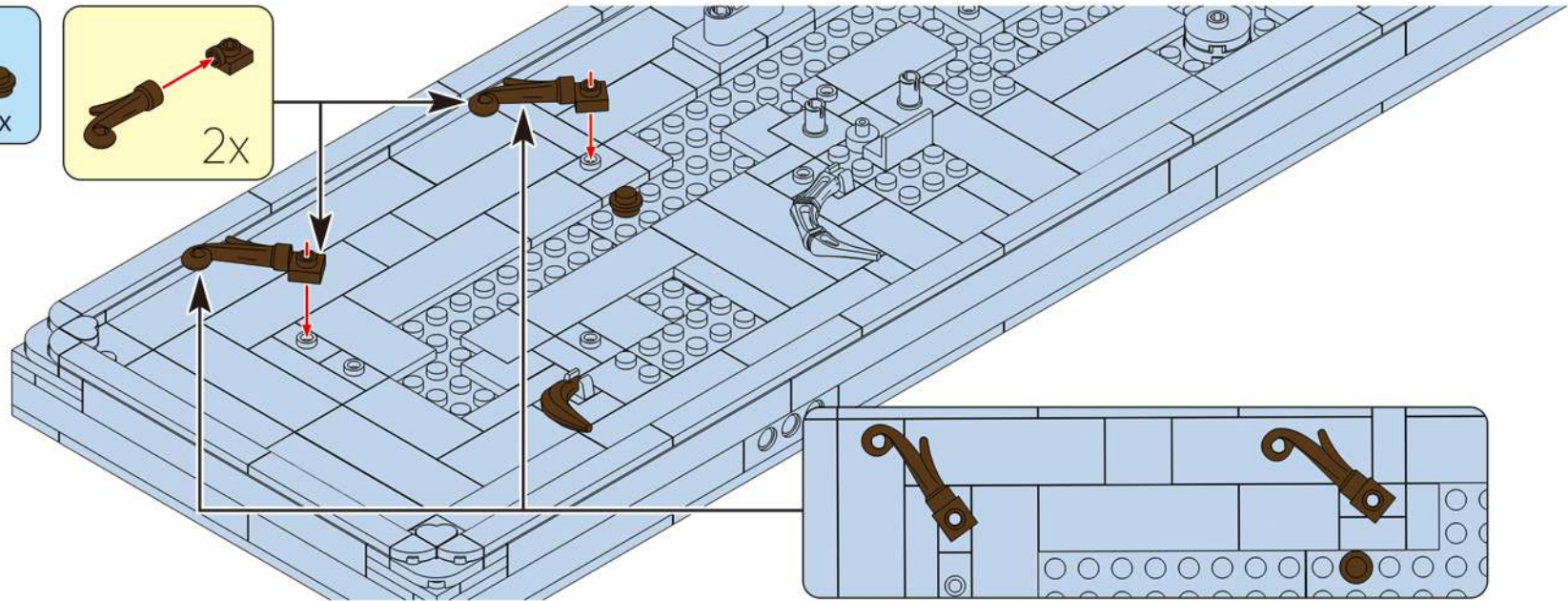
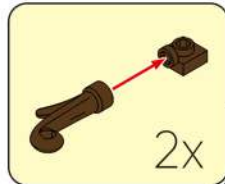

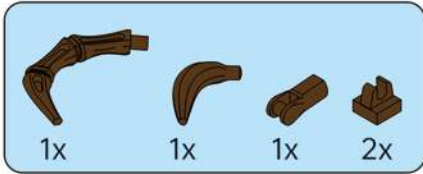

**106**

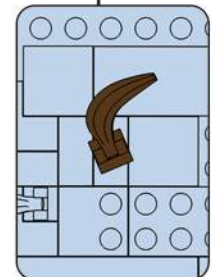
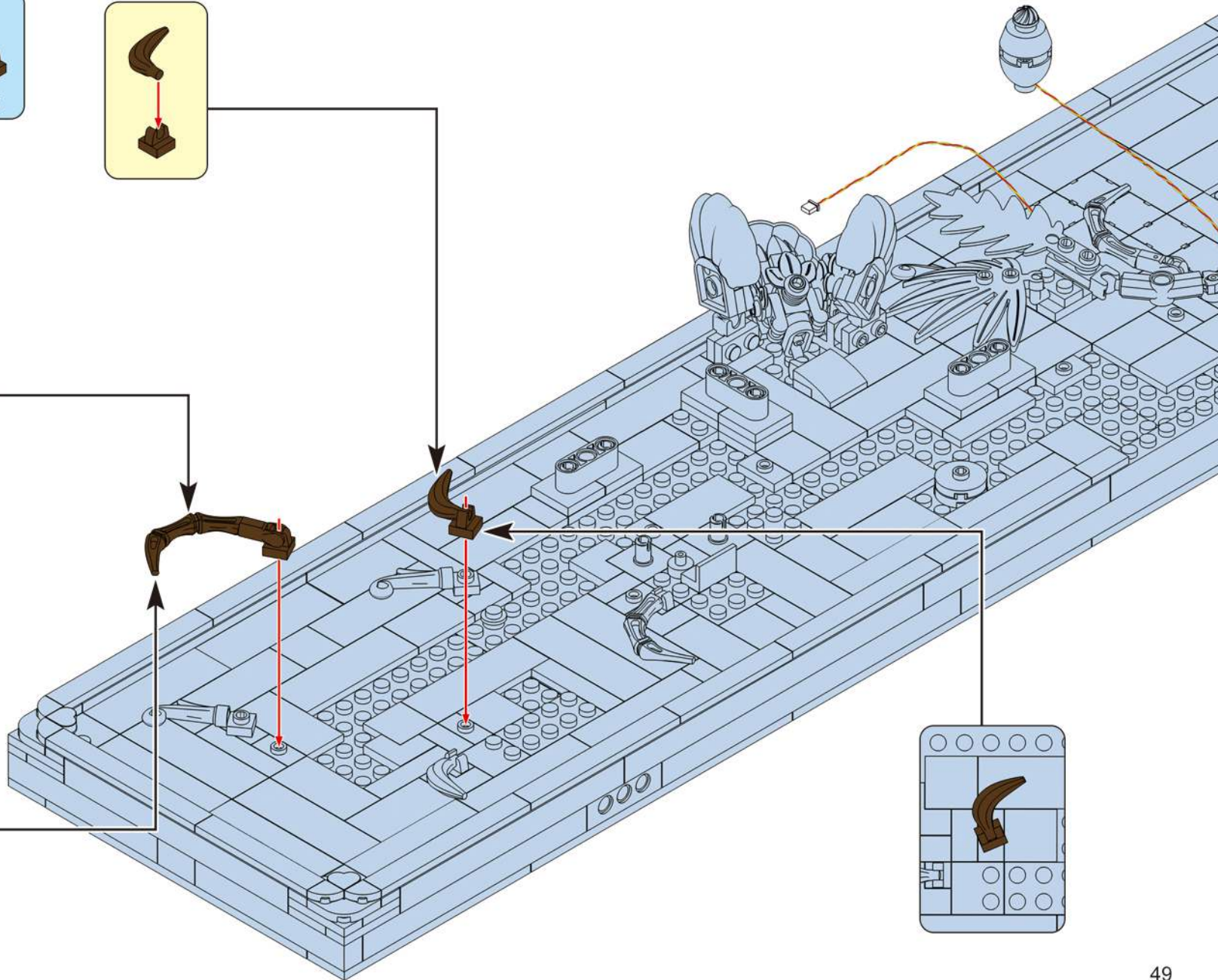
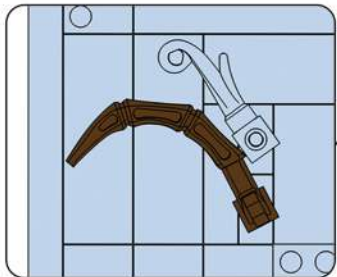
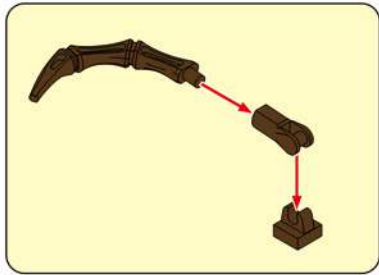
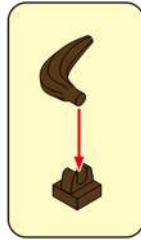

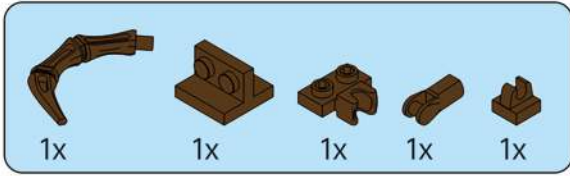

107

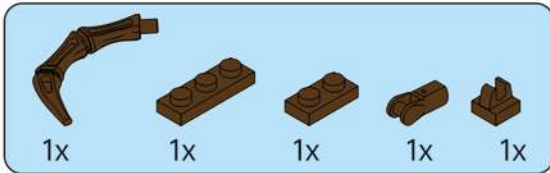
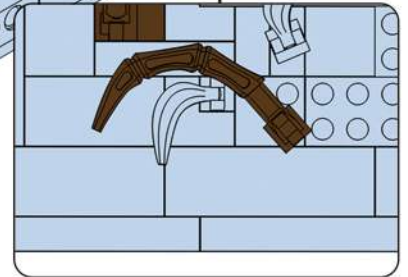
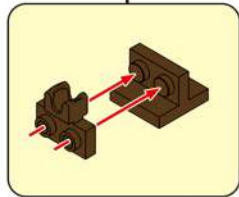
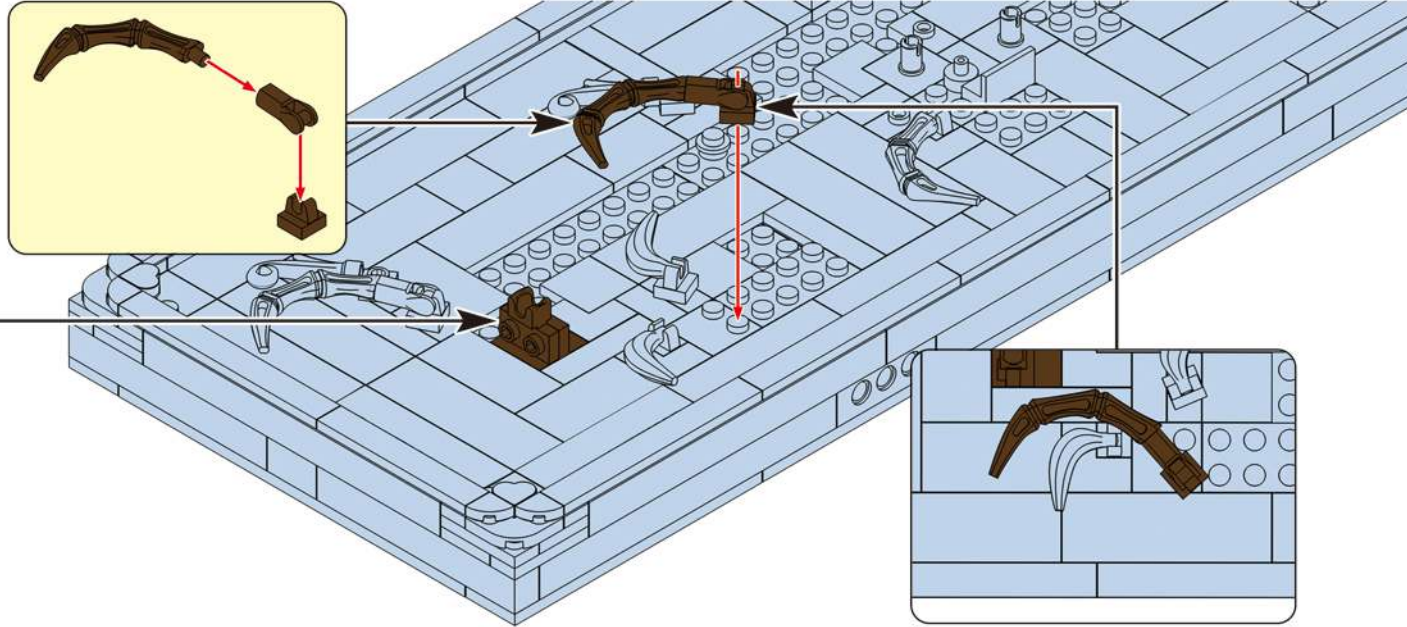

108

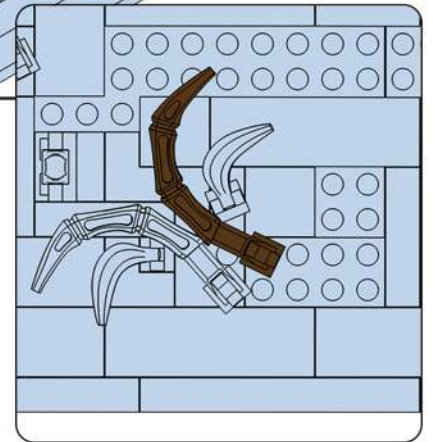
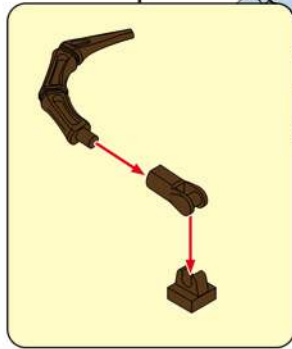
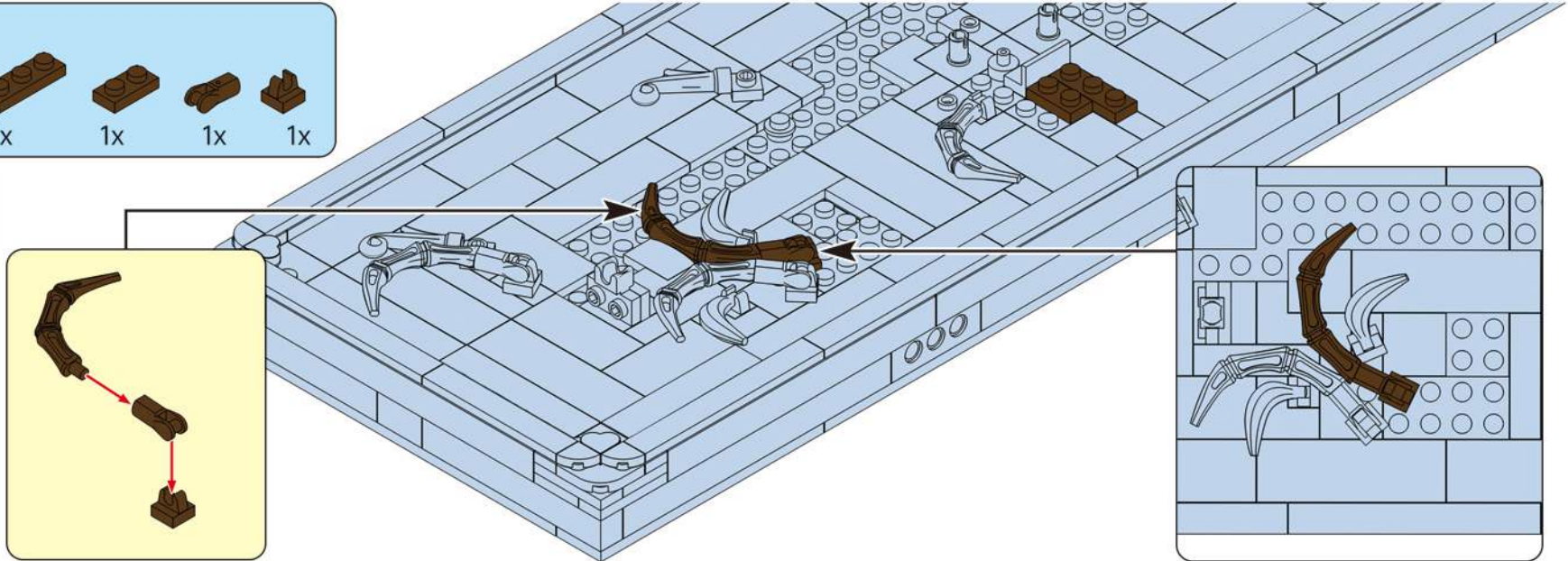

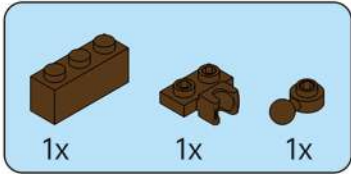

**109**

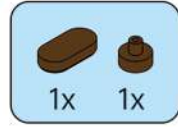
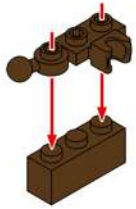

**110**

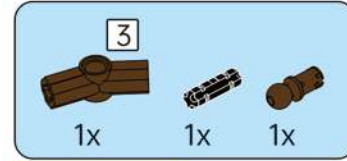
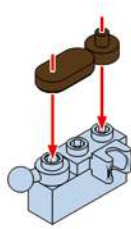

**111**

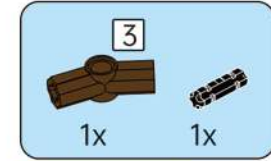
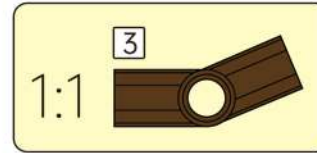
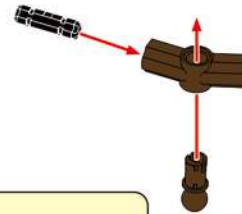

**112**

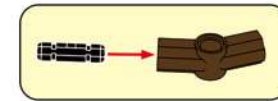

**113**

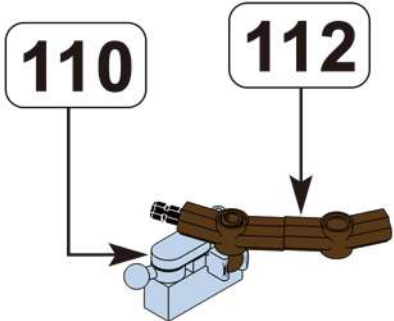

**114**

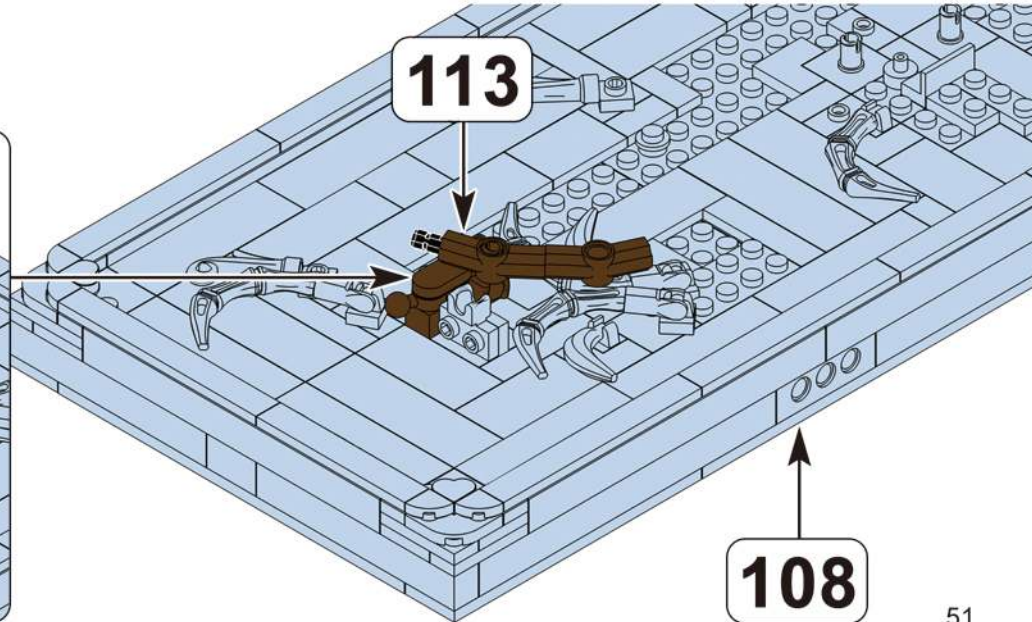
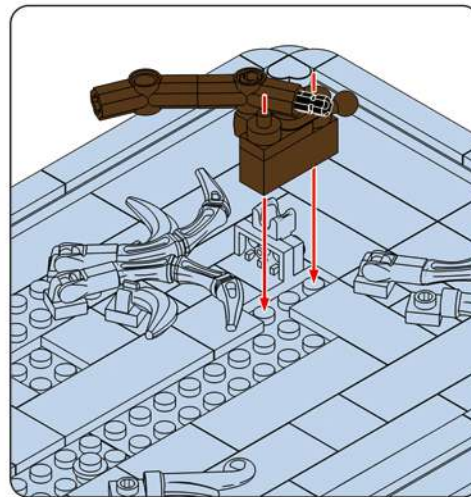

**108**

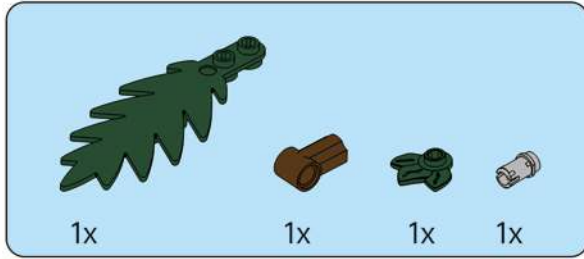

115

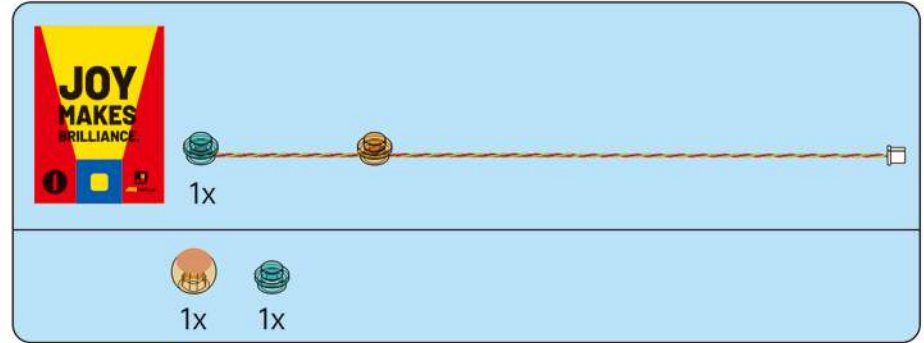
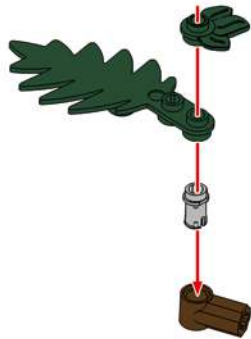

116

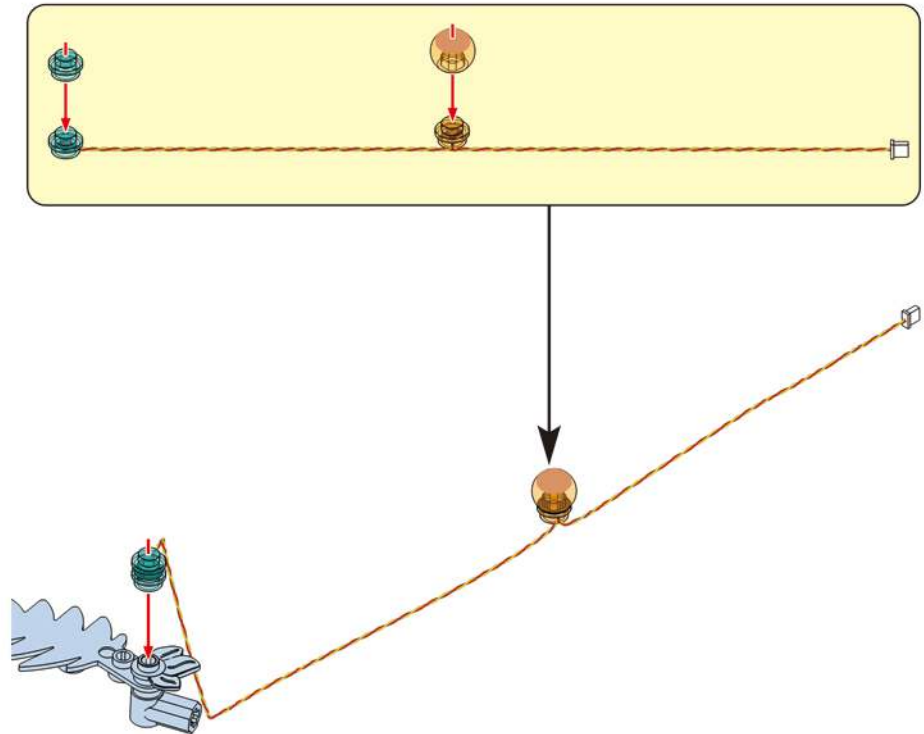

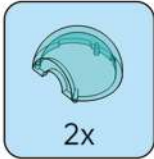

# 117

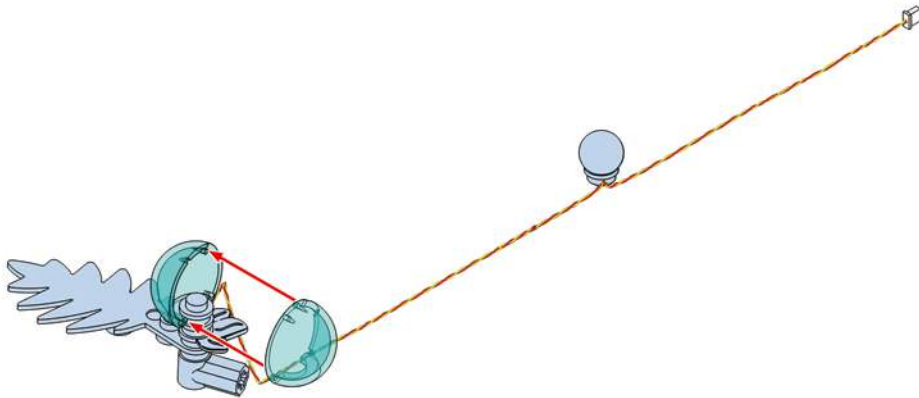

# 118

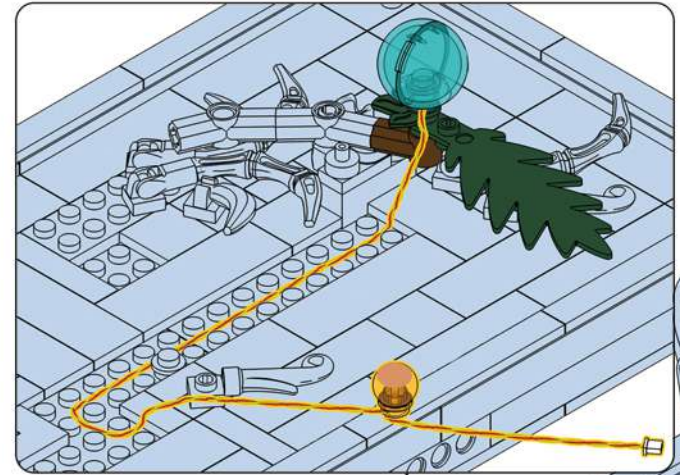

This component will be assembled in the subsequent steps.

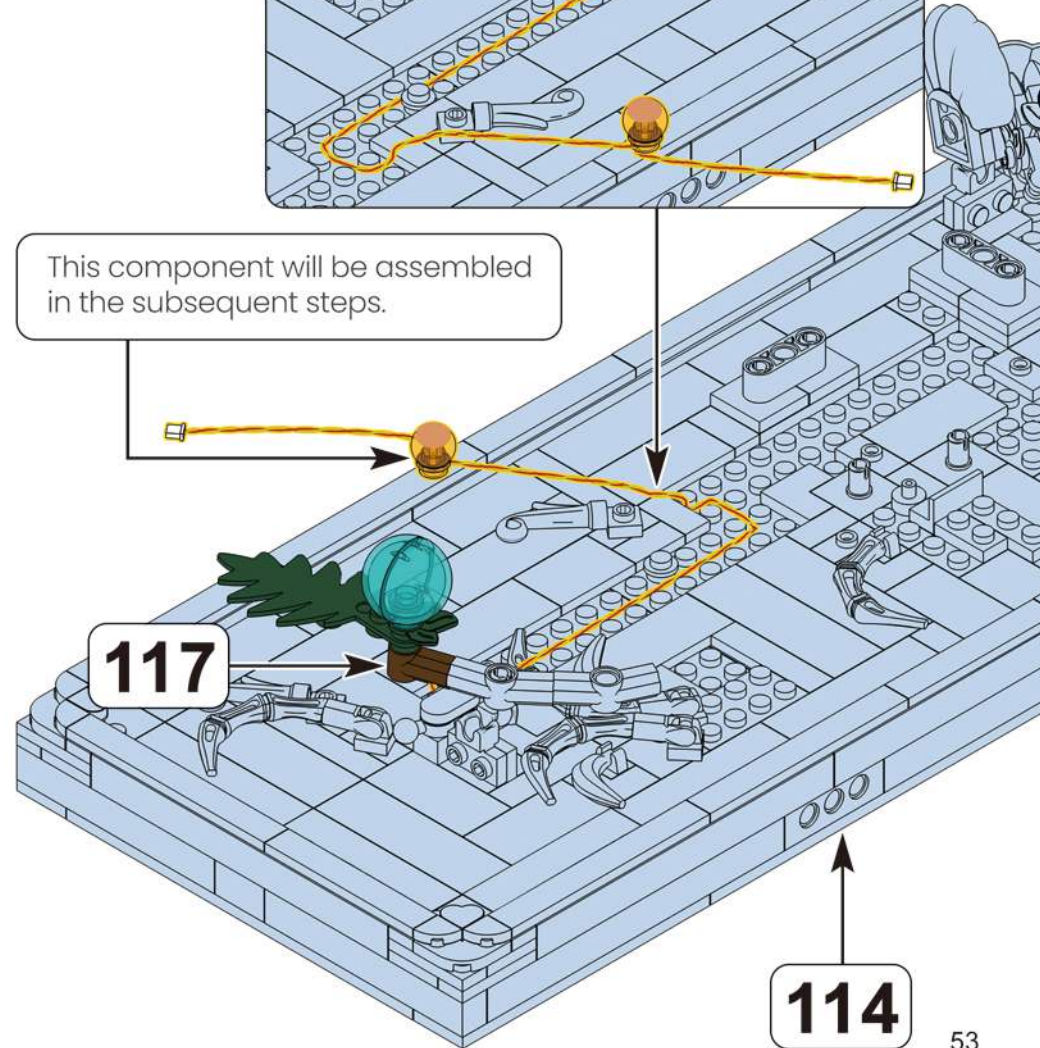

# 114

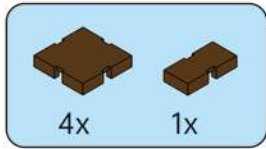

**119**

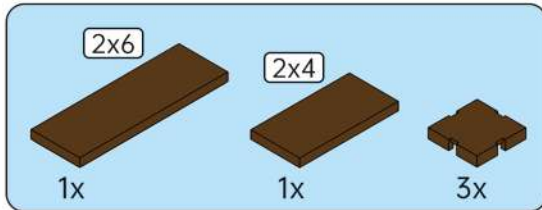
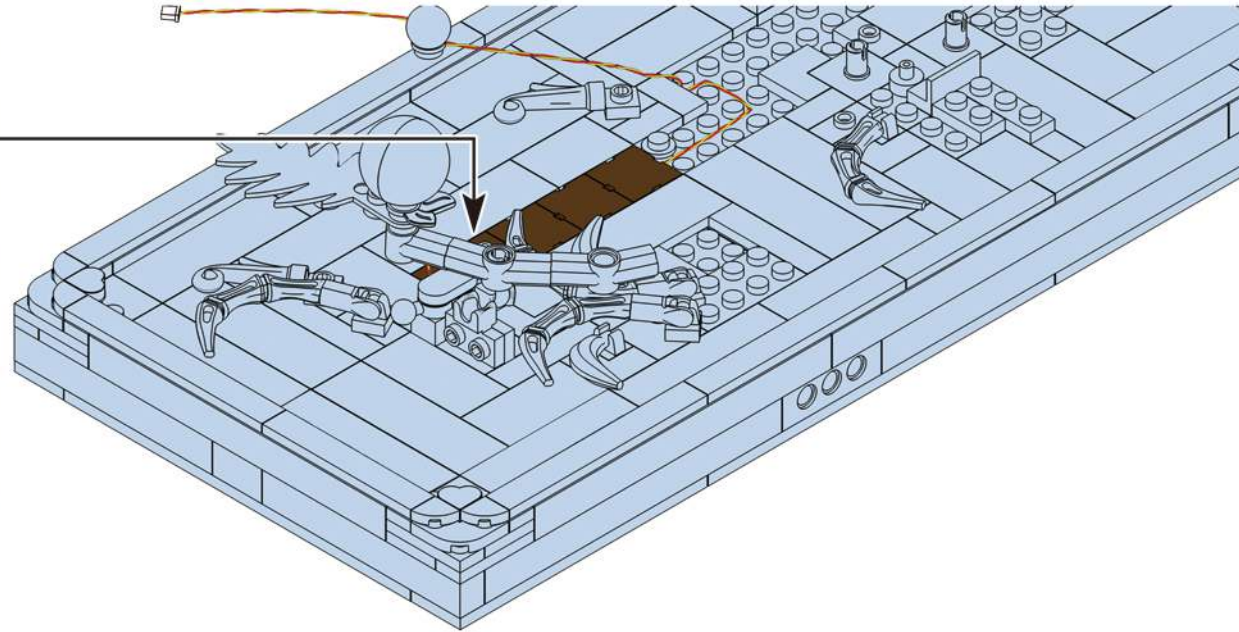
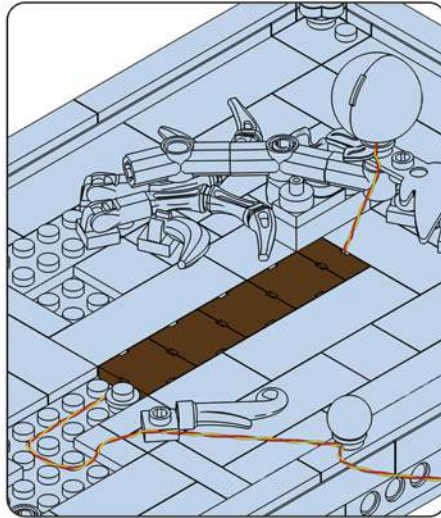

**120**

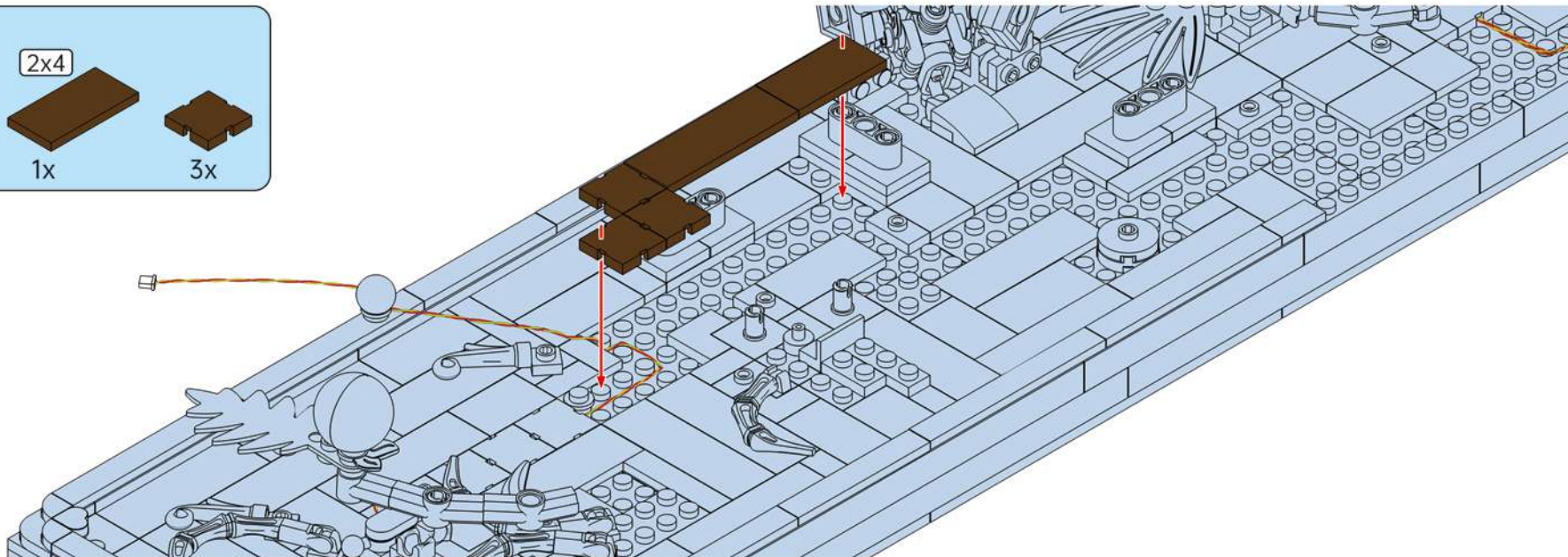

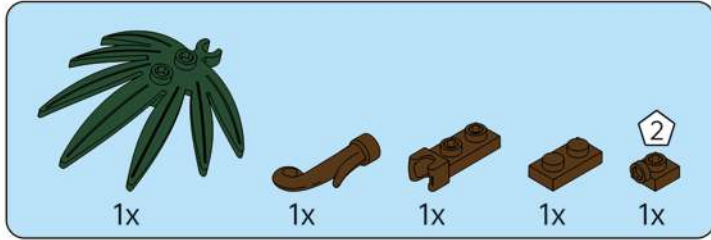

121

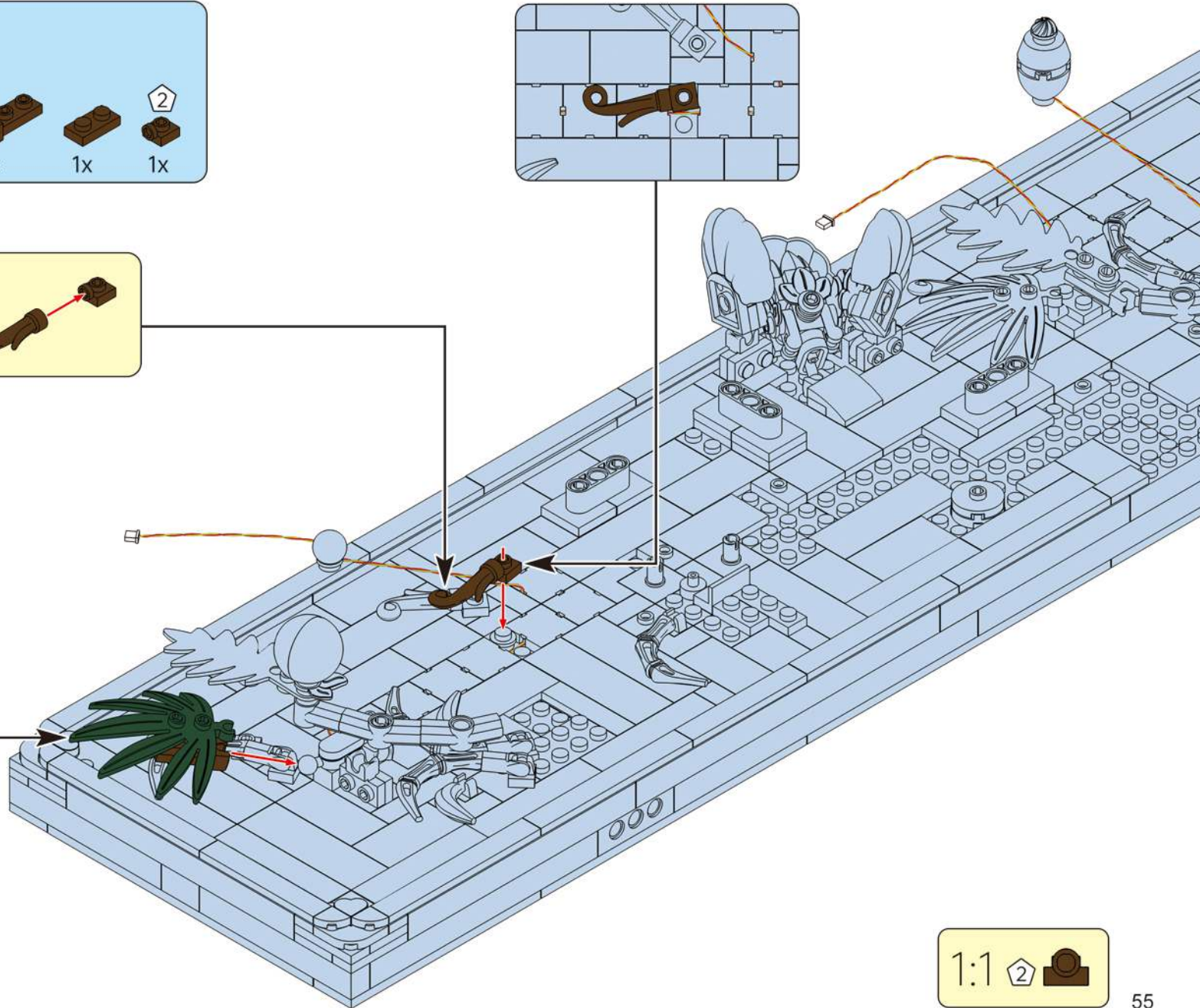
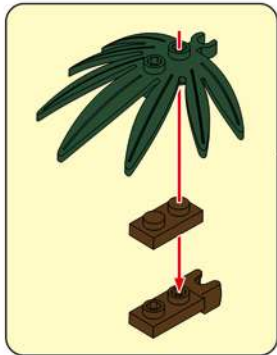
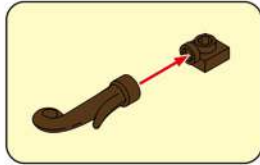

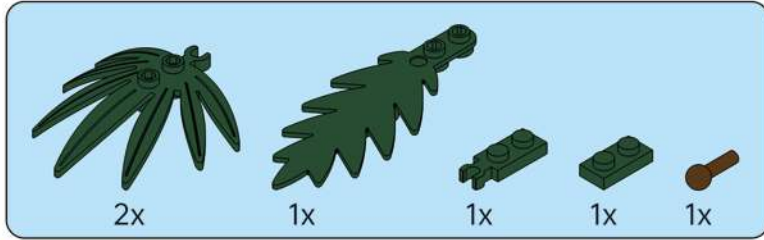

122

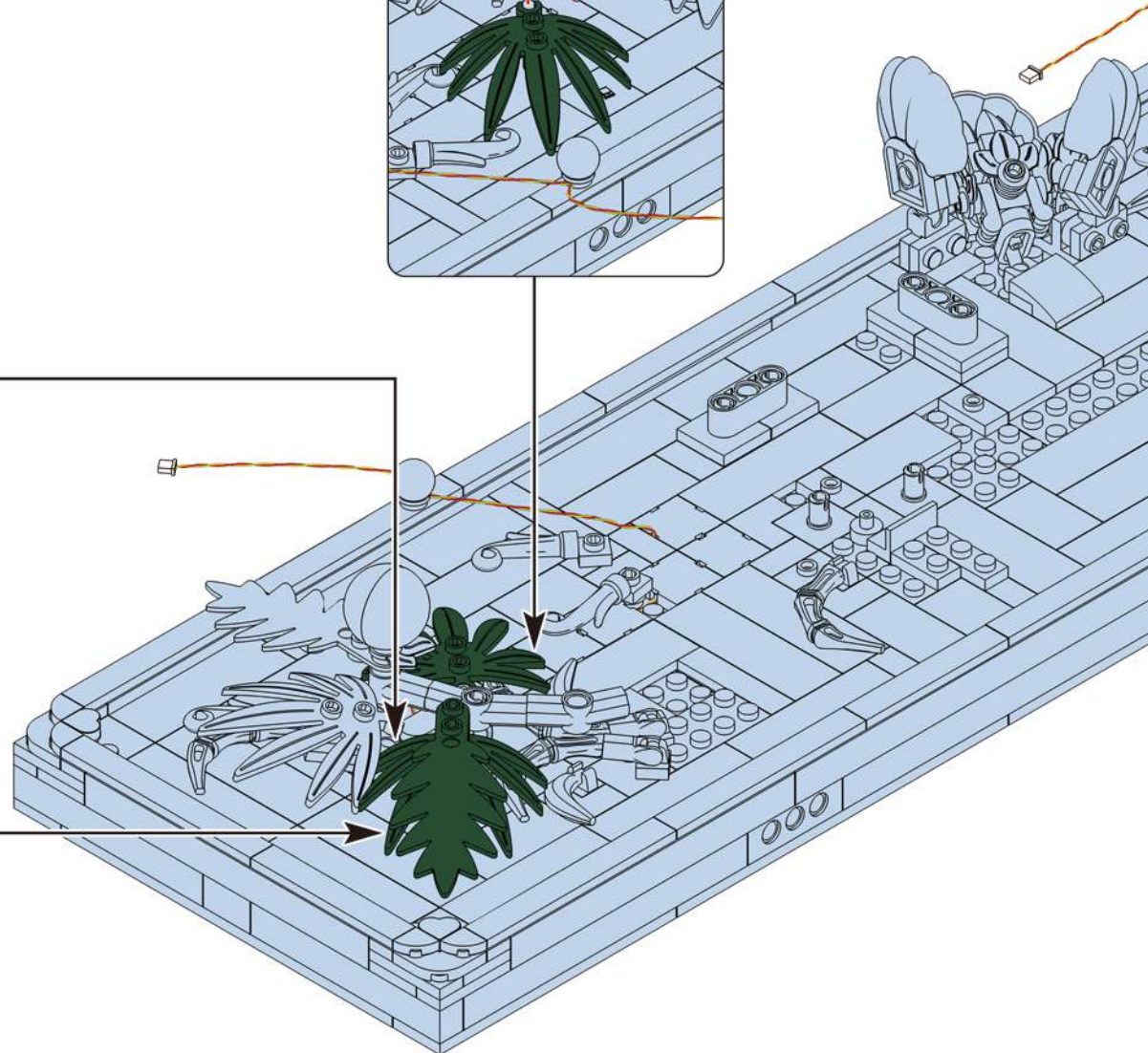
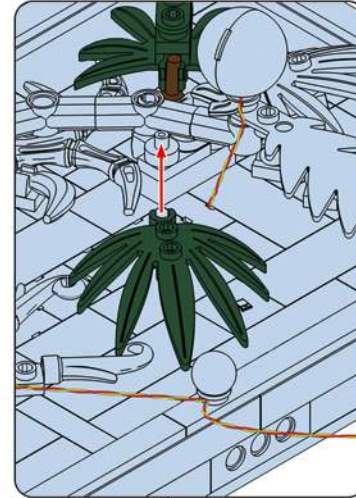
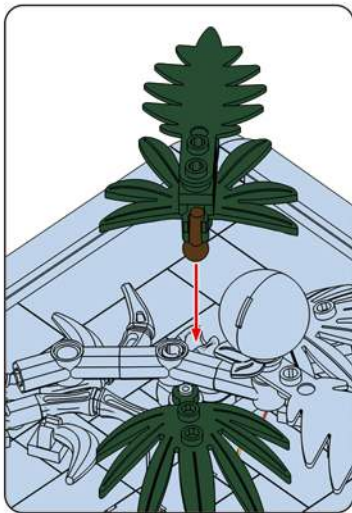
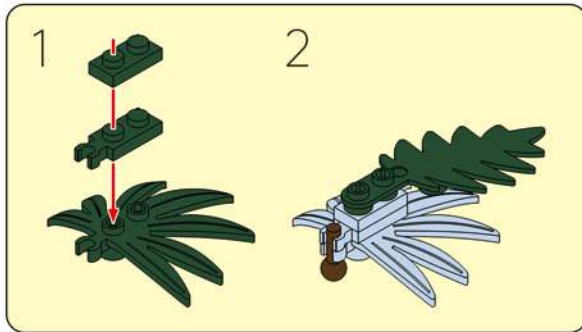

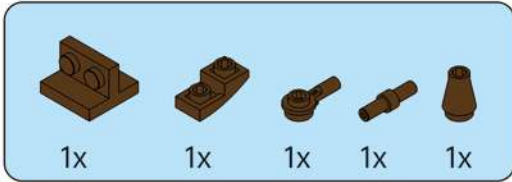

# 123

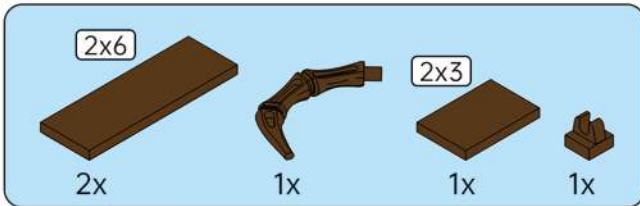
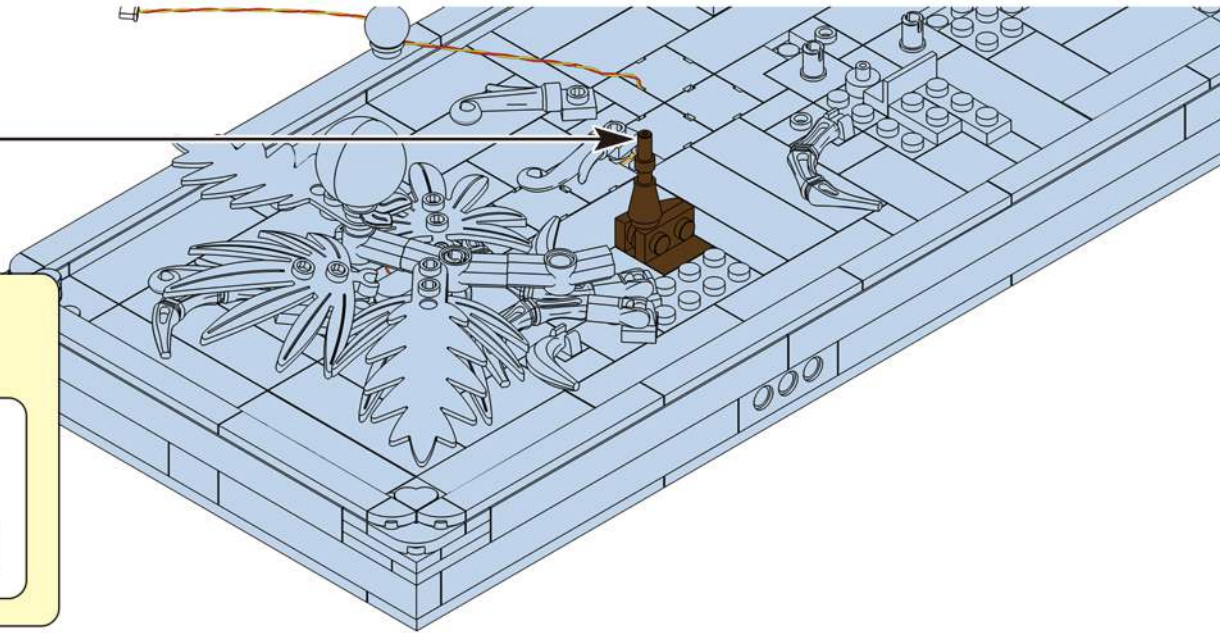
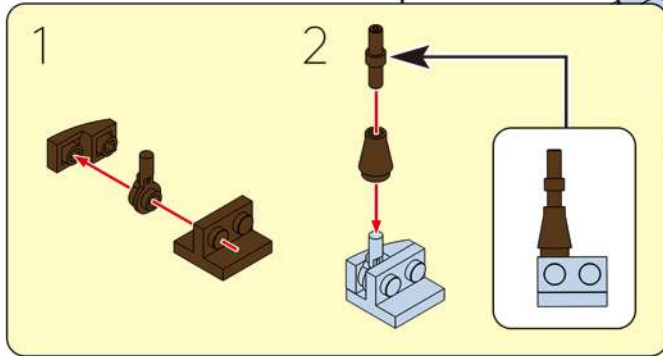

# 124

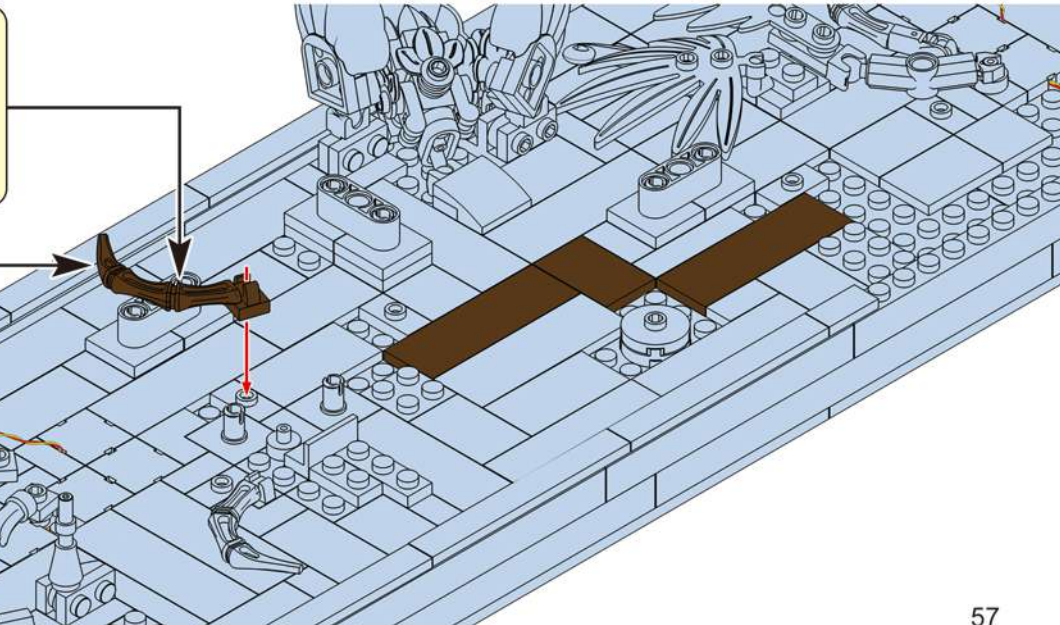
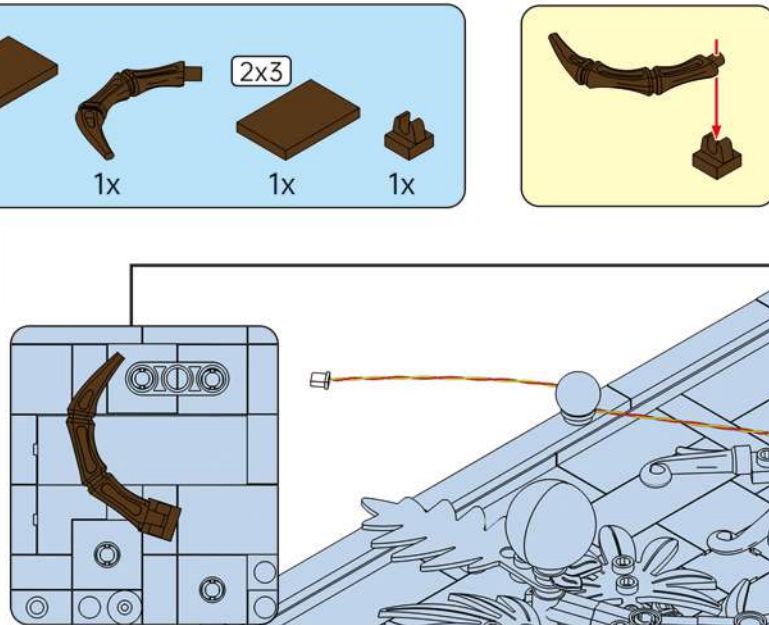

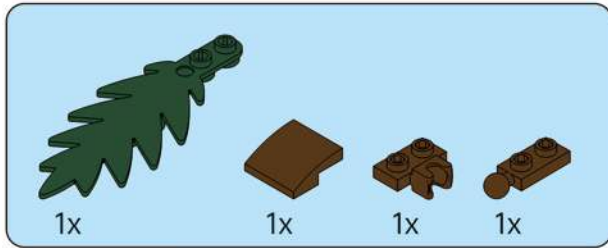

125

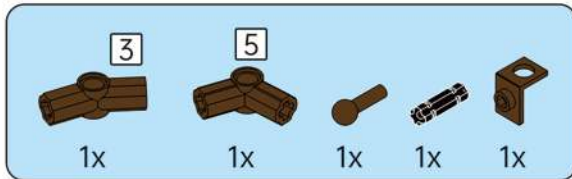
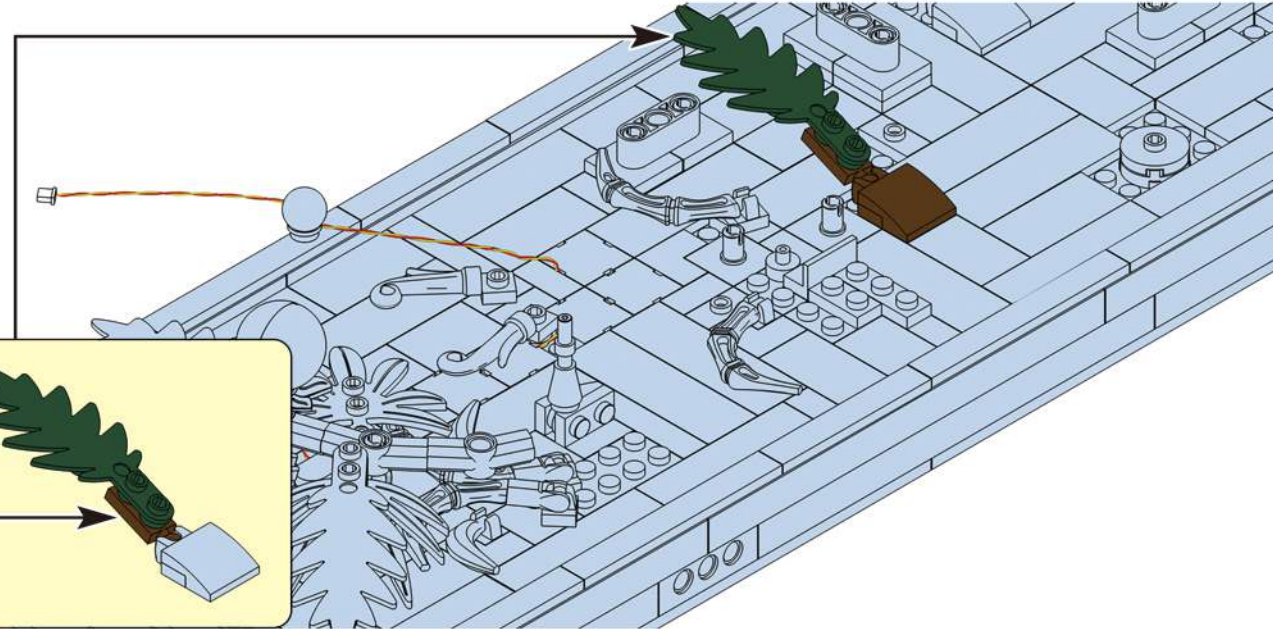
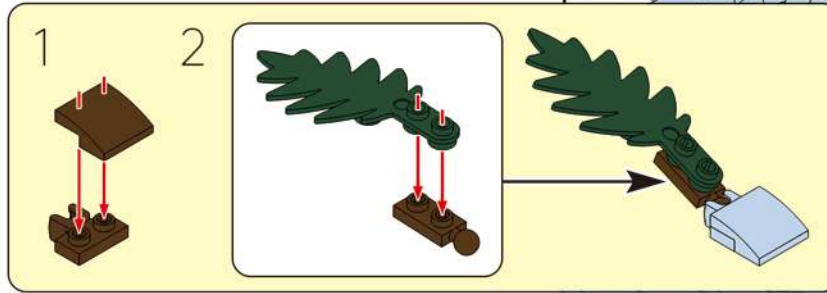

126

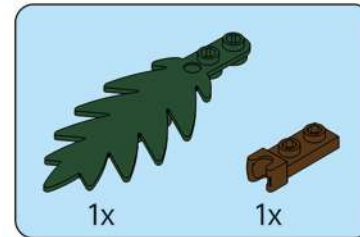
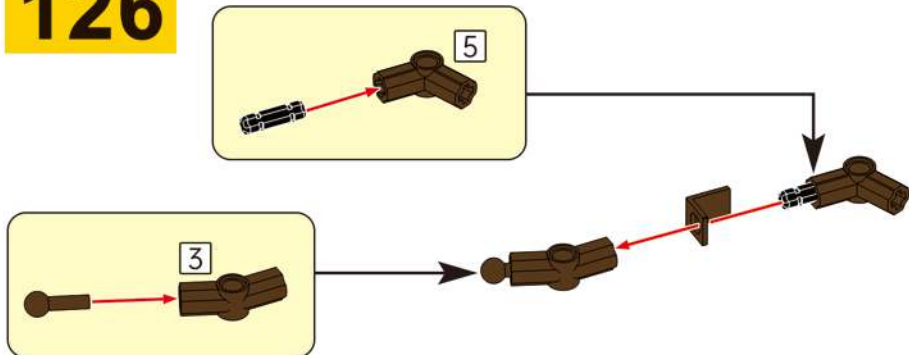

127

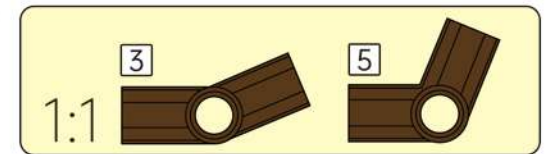
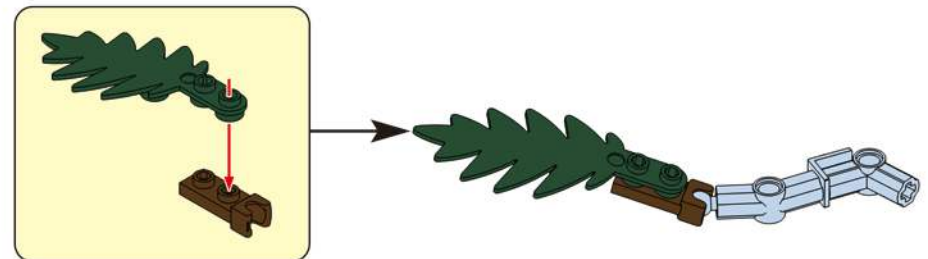

128

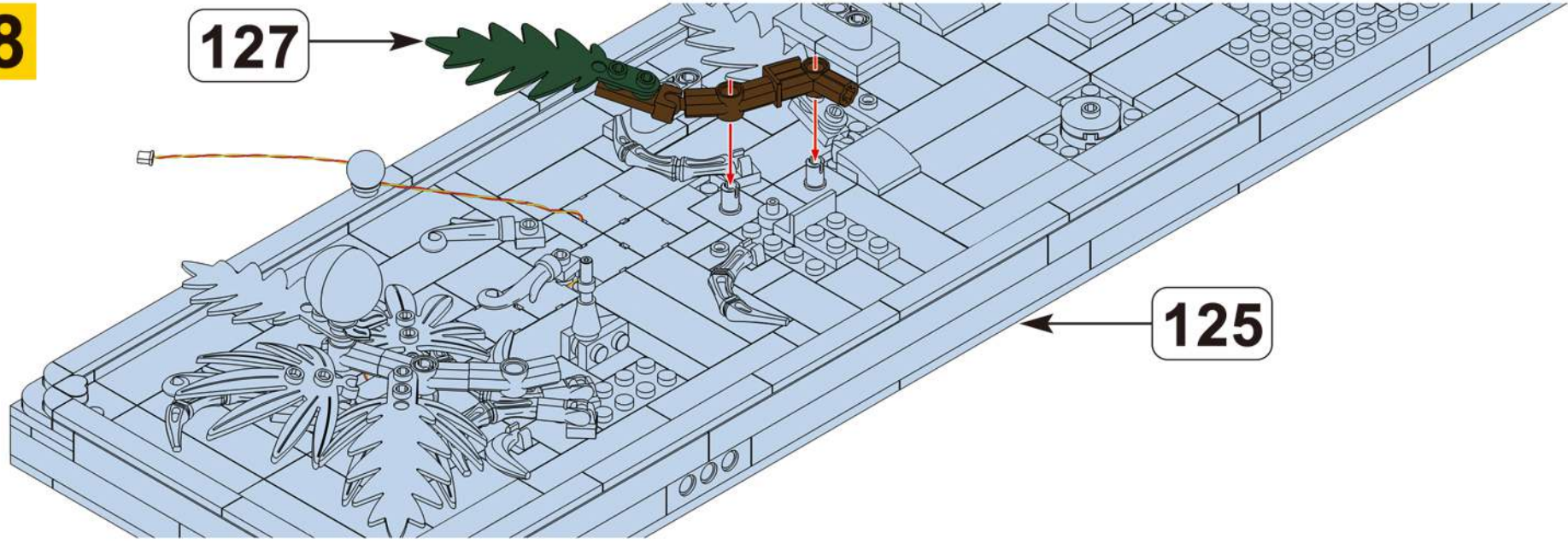

- 1x
- 1x
- 1x
- 1x
- 2x

129

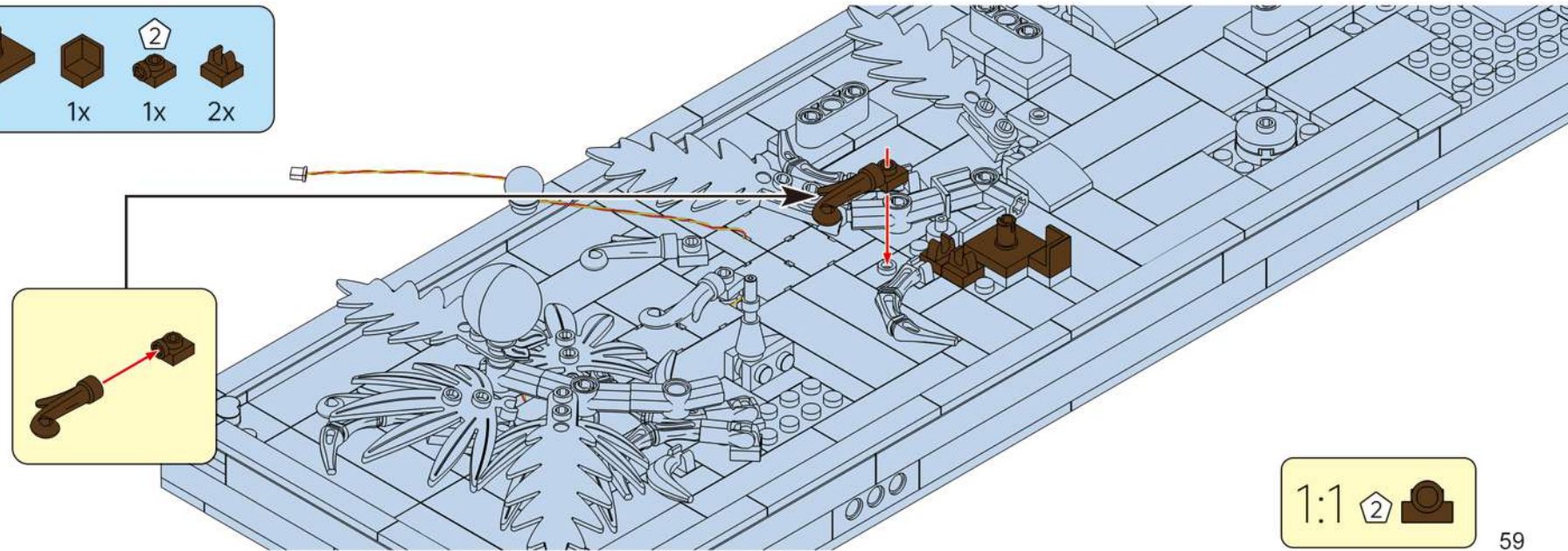

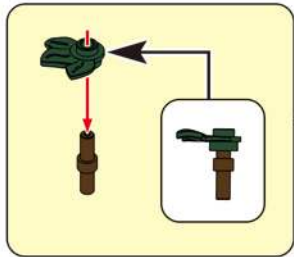
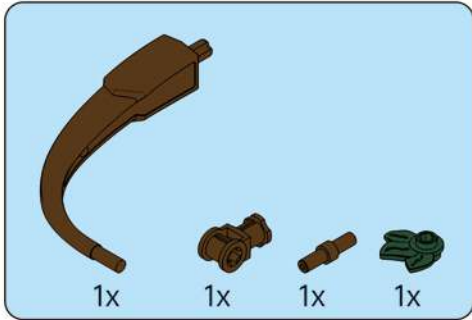

**130**

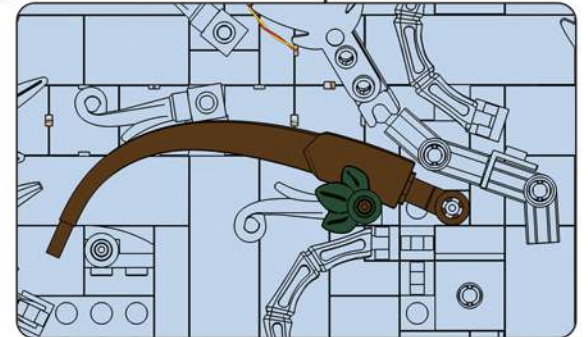
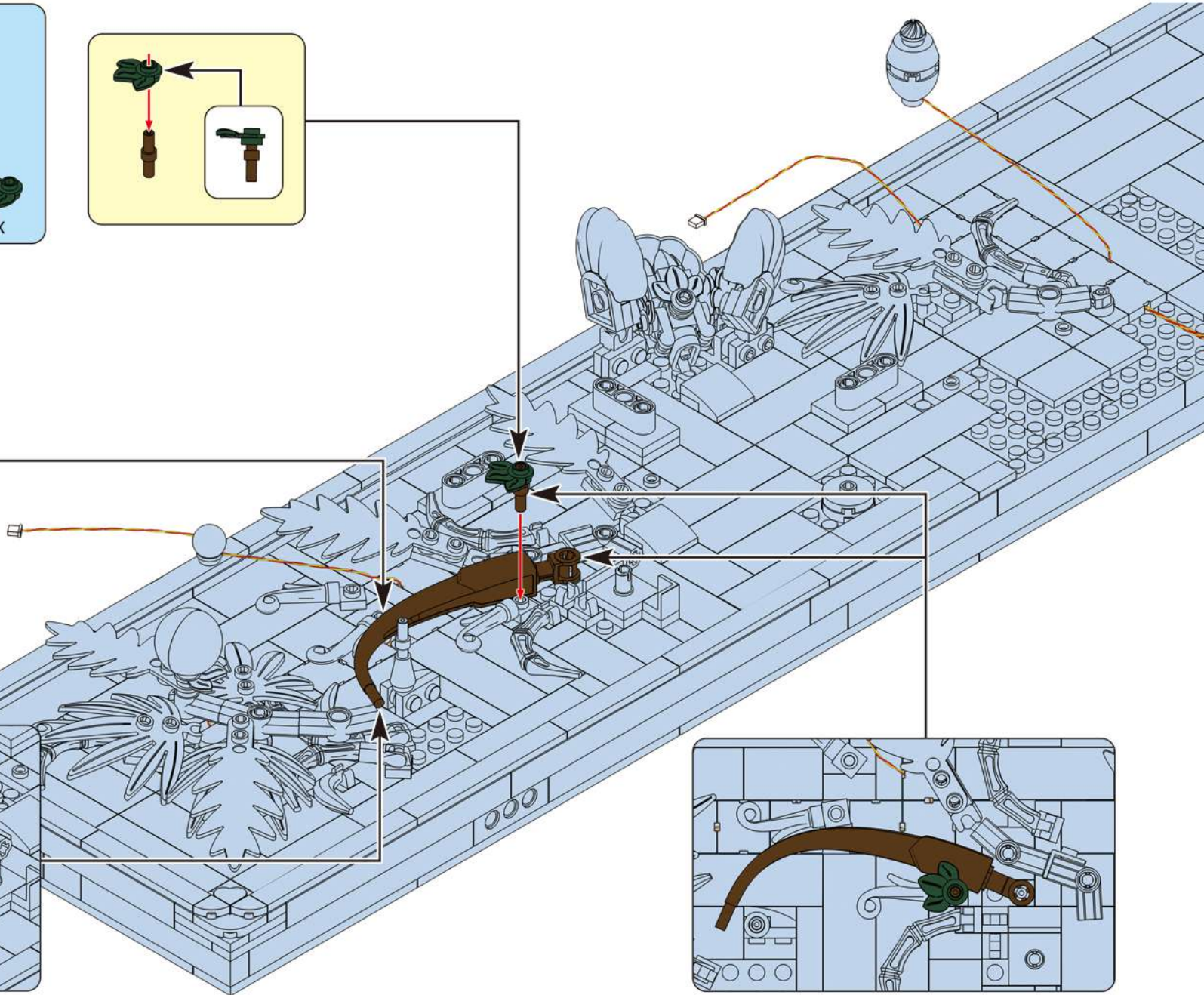
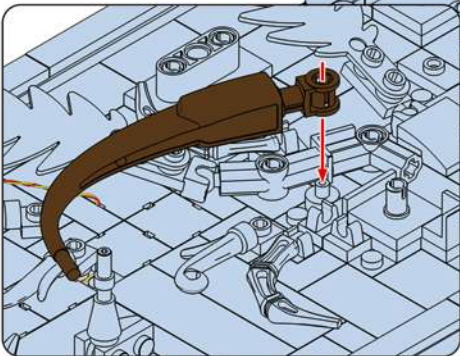
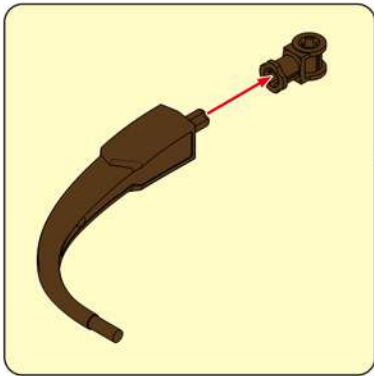

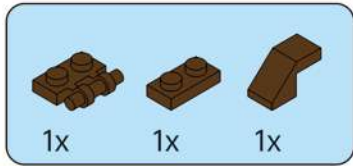

131

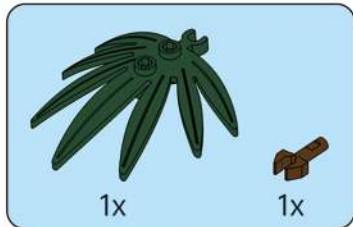
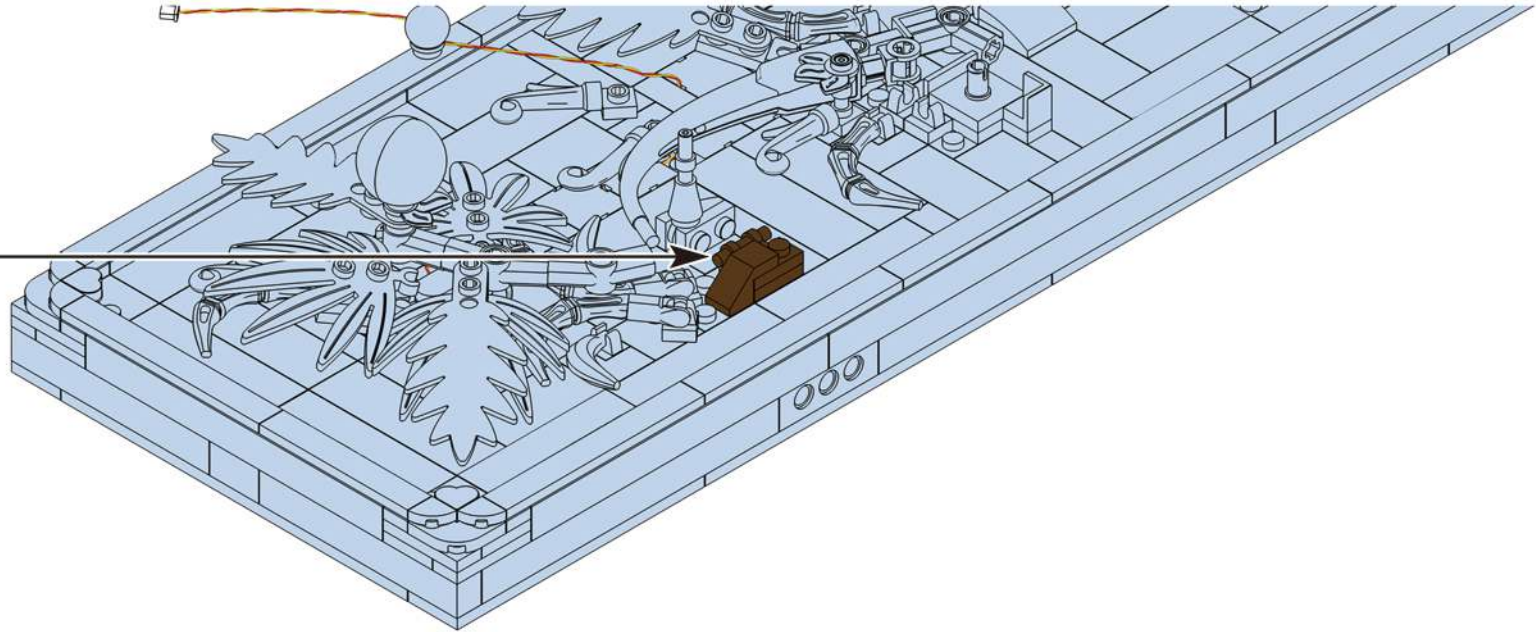
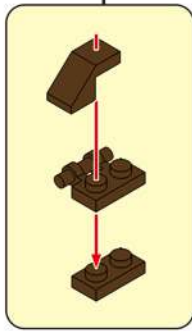

132

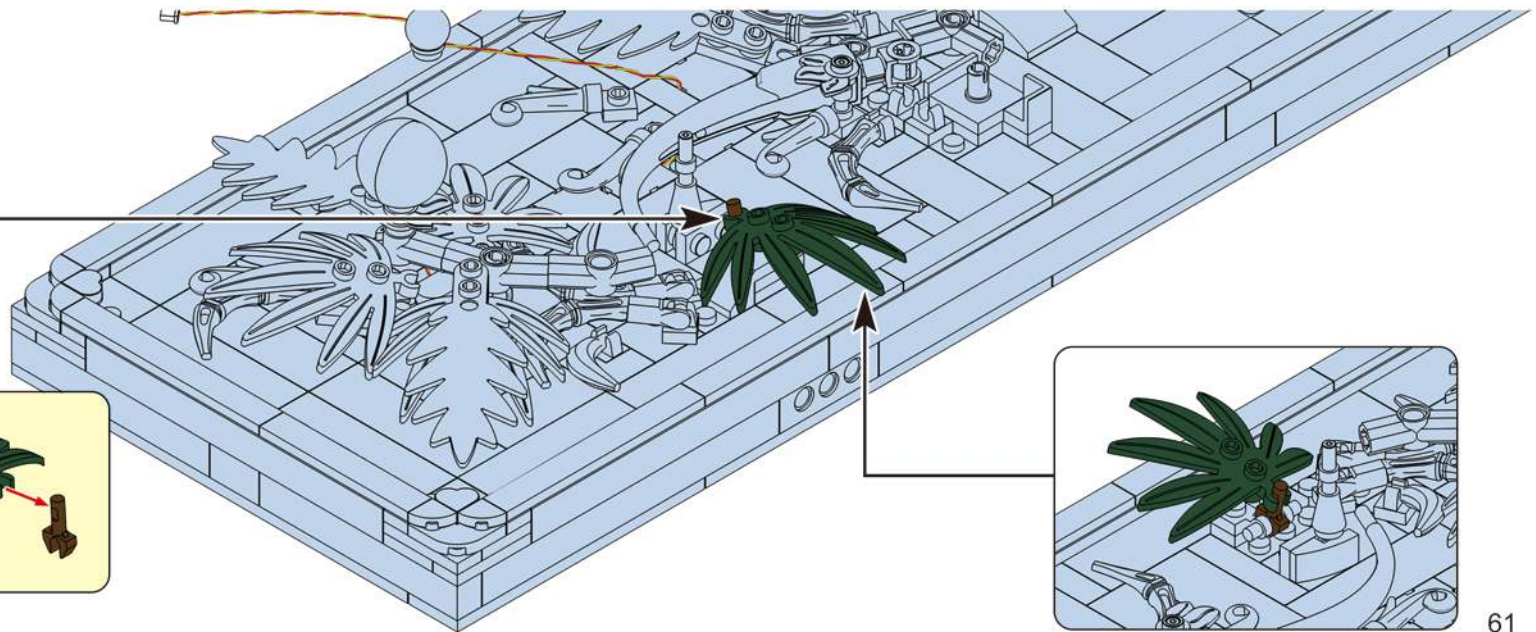
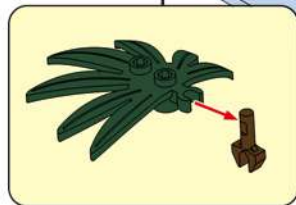

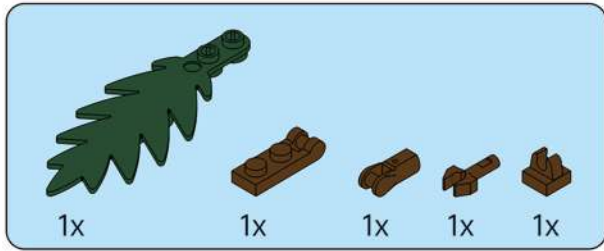

133

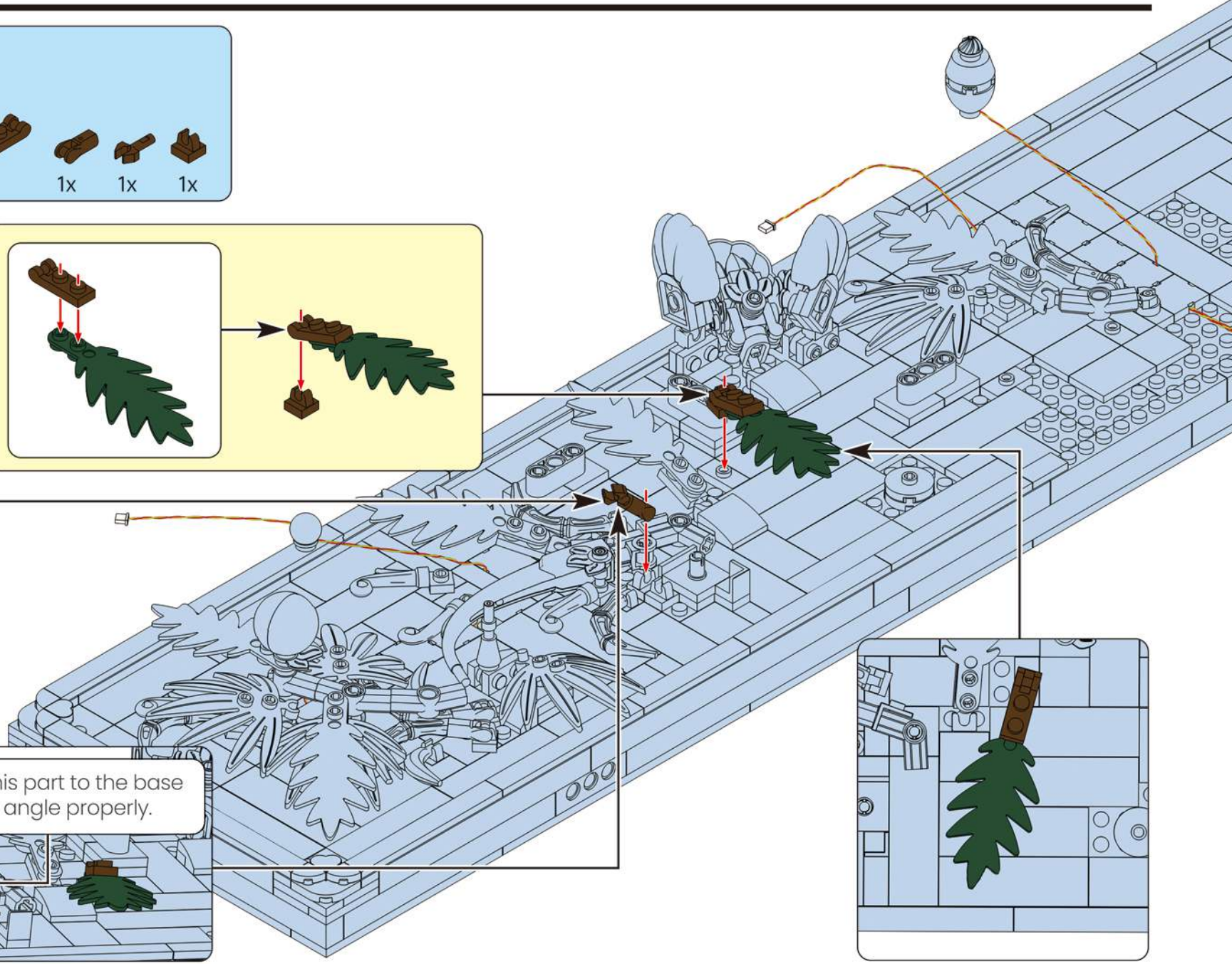
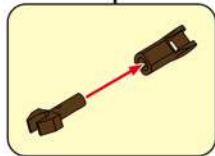
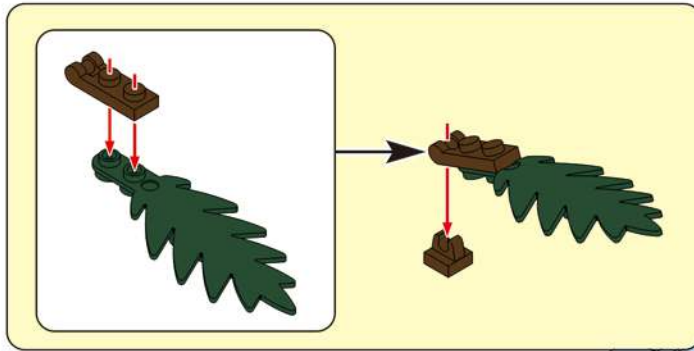

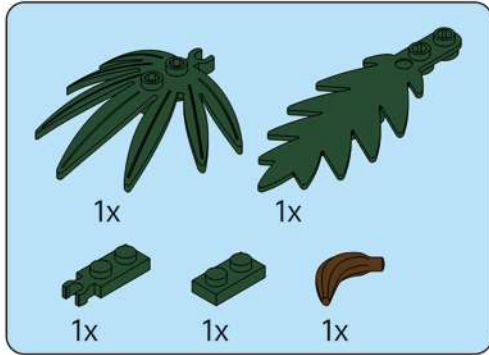

134

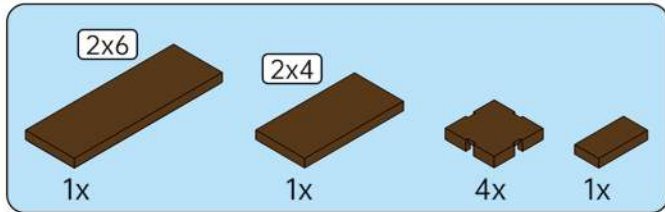
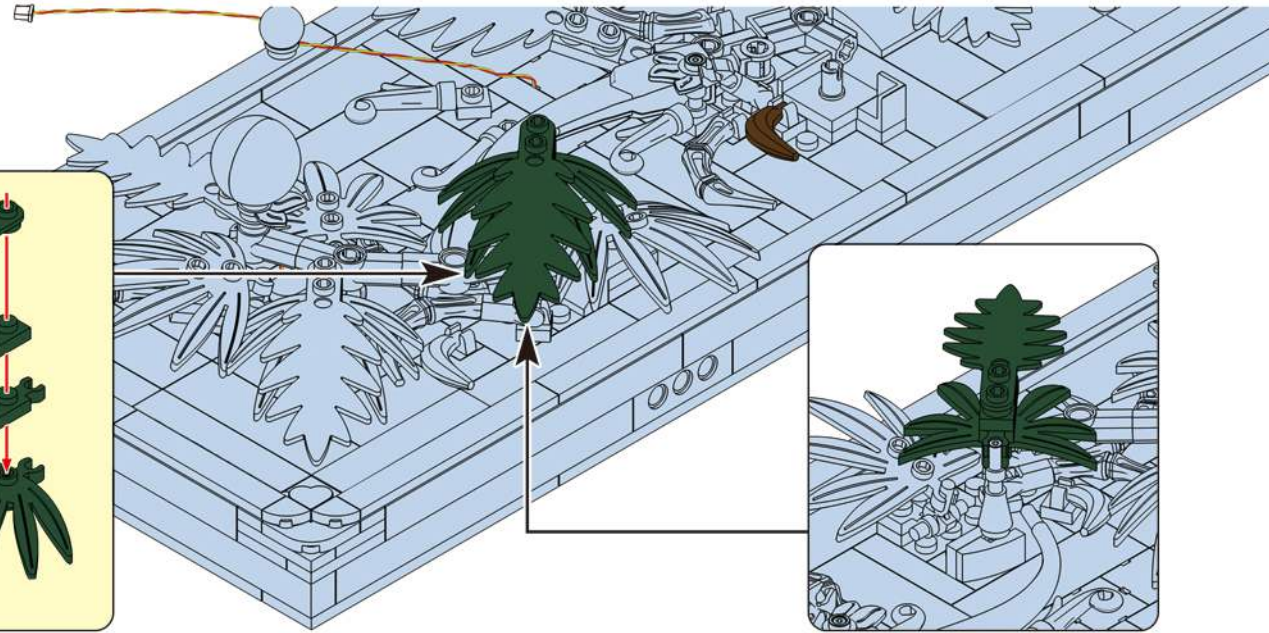

135

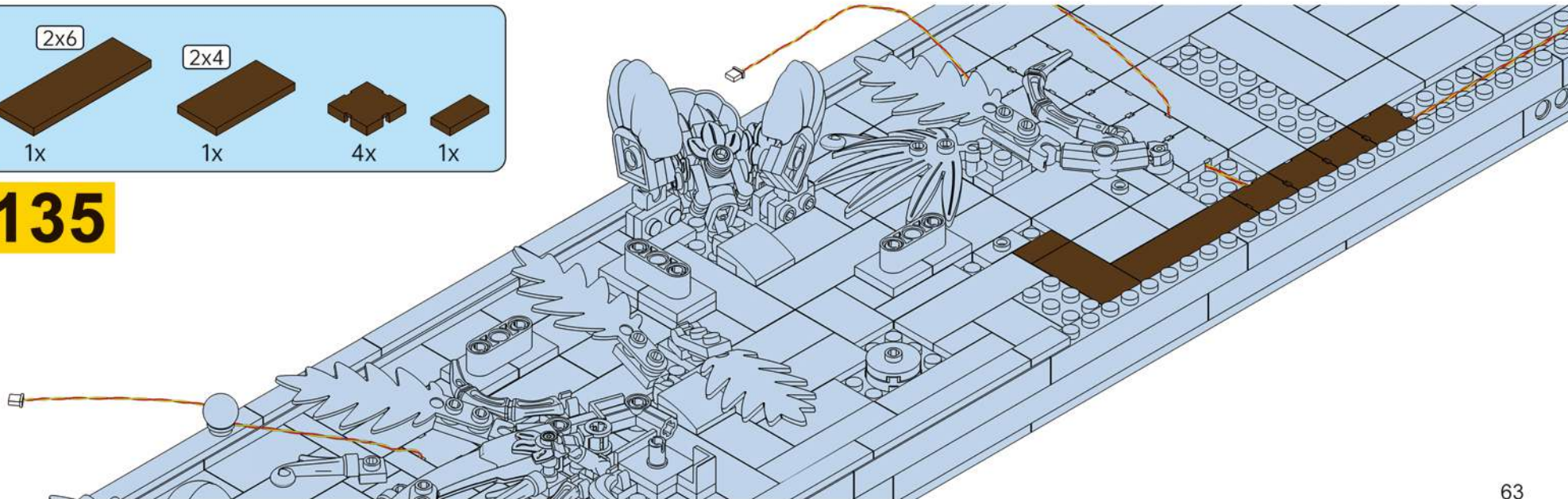

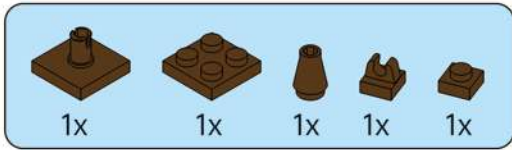

# 136

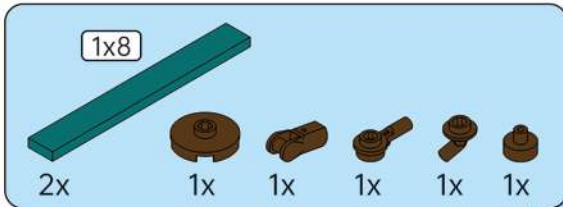
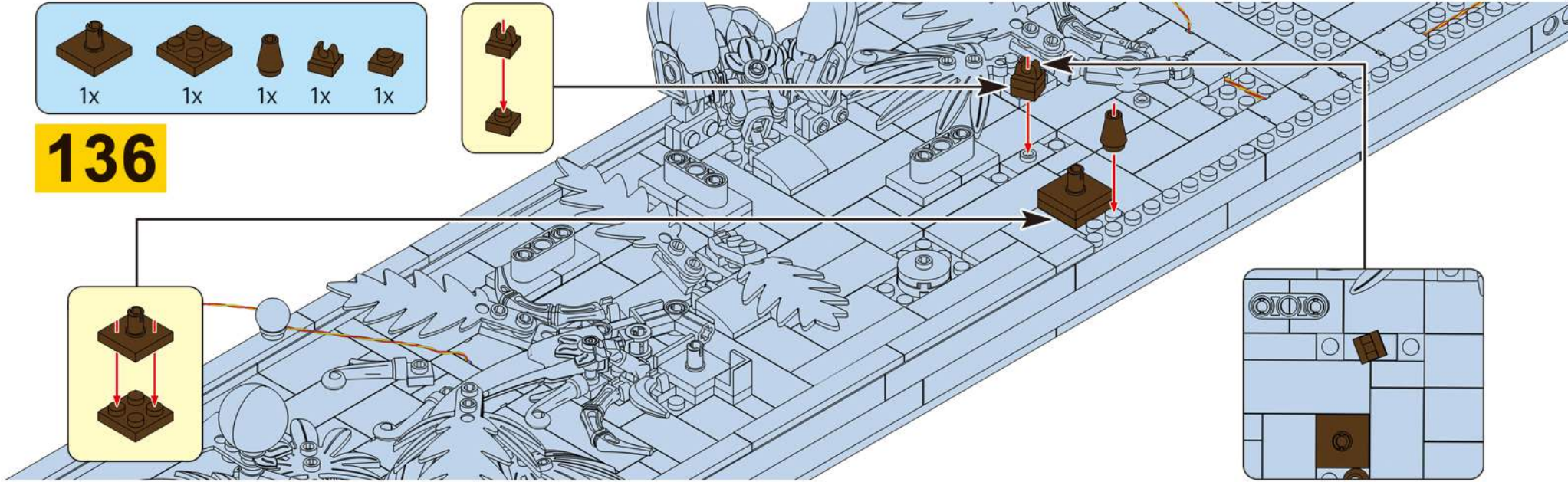
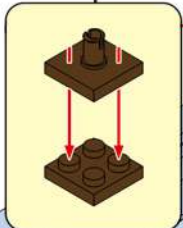
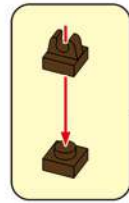

# 137

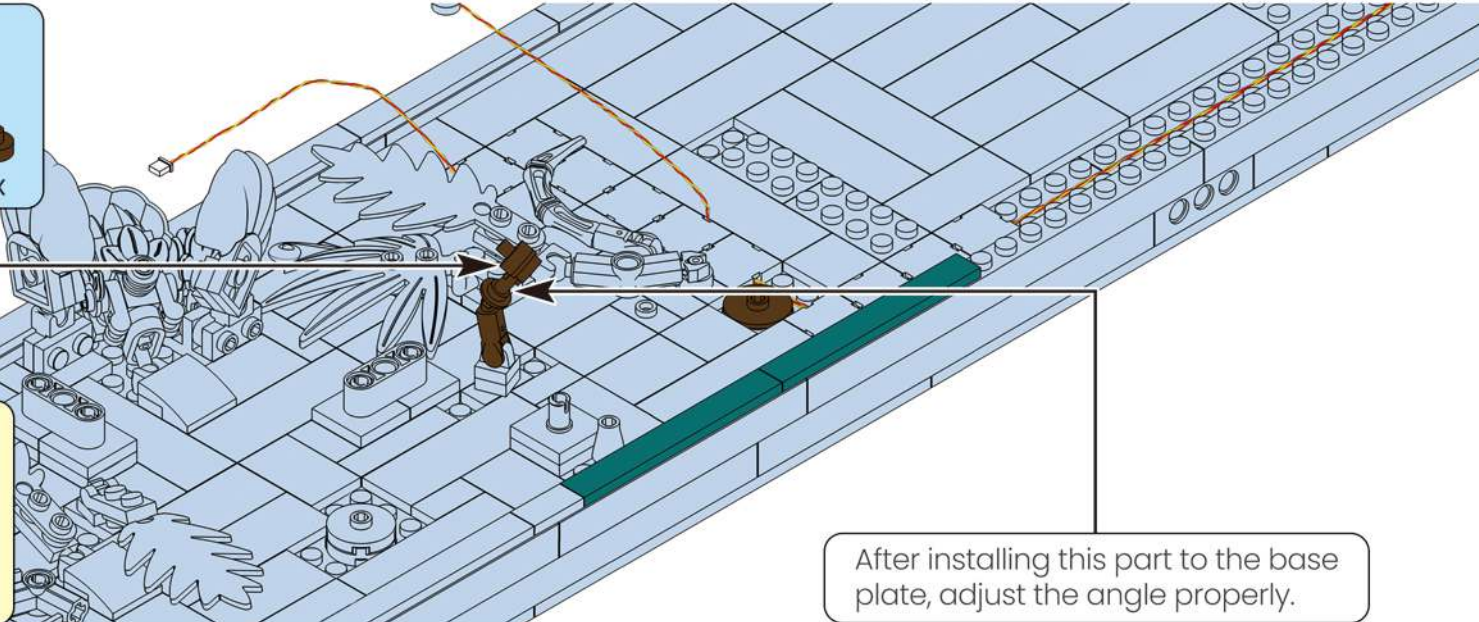
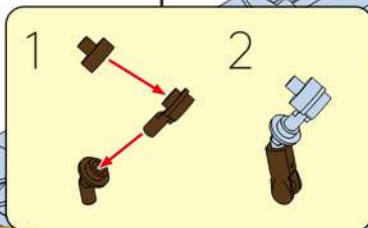

After installing this part to the base plate, adjust the angle properly.

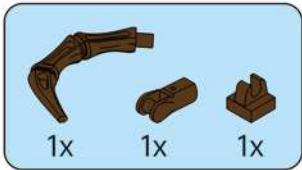

# 138

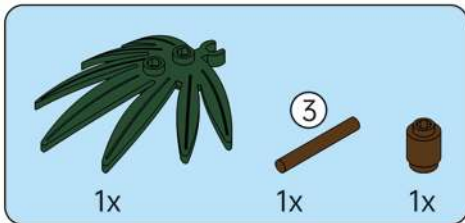
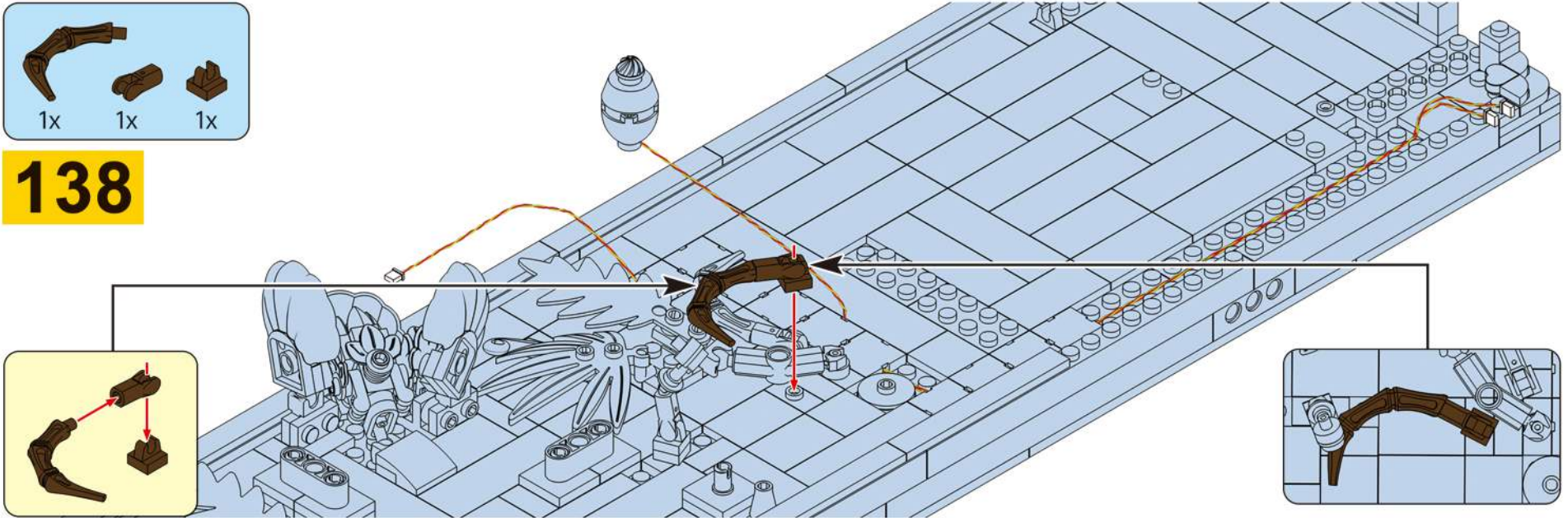

# 139

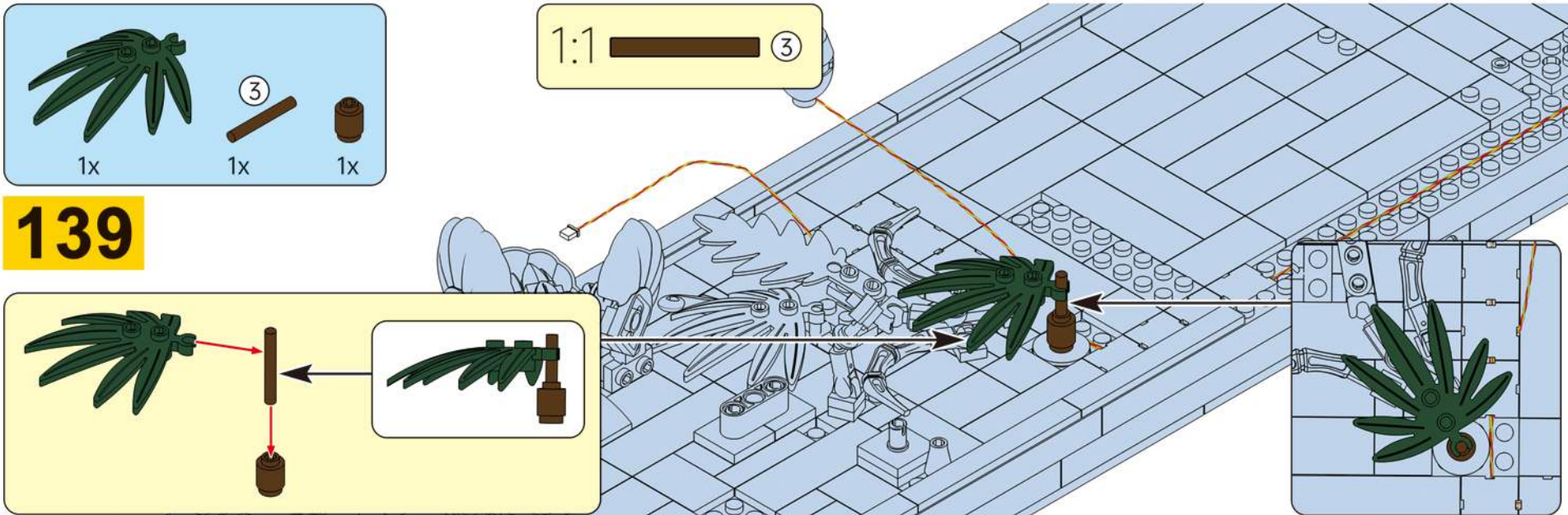

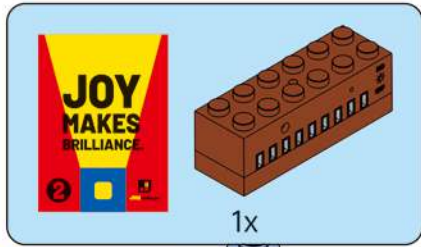

**140**

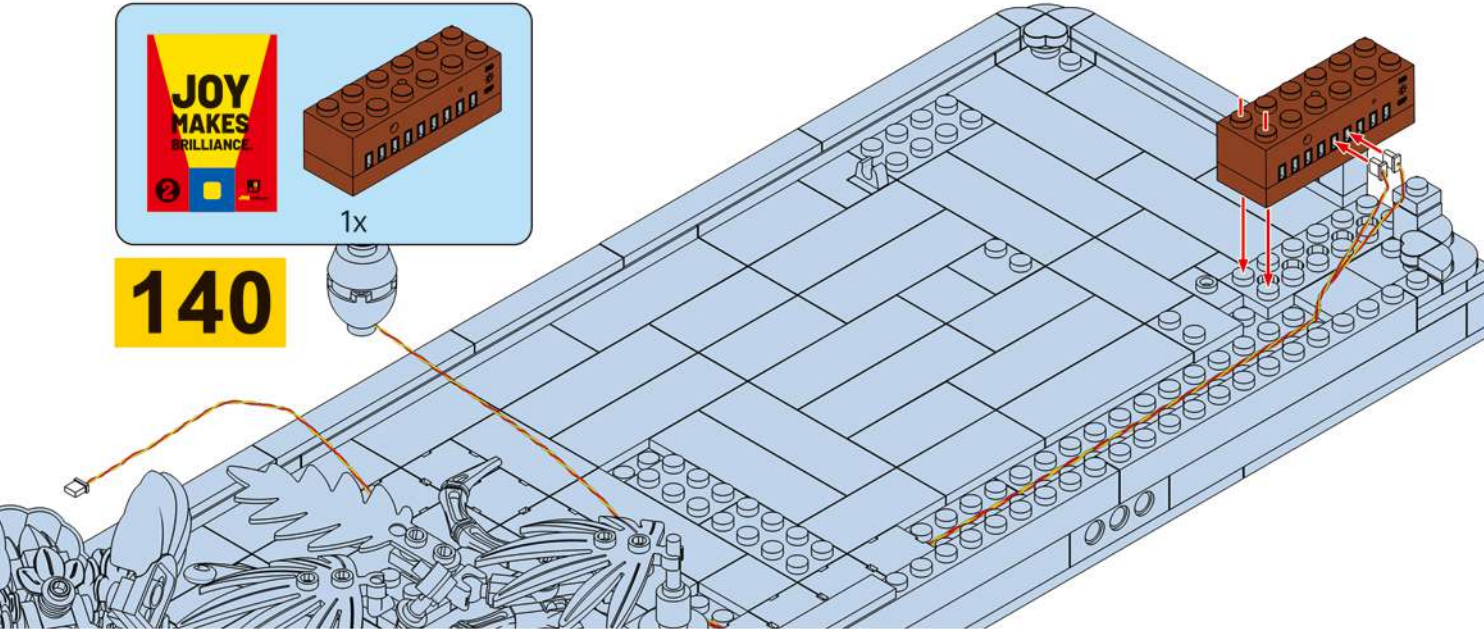

Connectors can be inserted into ports of the expansion boards in only one way. Make sure the plug faces the right way before connecting.

Tips: If the plug doesn't fit easily into a port connector, please don't force it. Otherwise, it will damage the plug and connector, and even cause a short circuit. If you suspect a short circuit, **DISCONNECT POWER IMMEDIATELY** to avoid dangers.

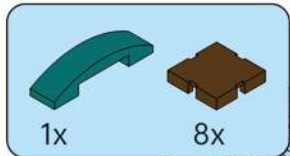

**141**

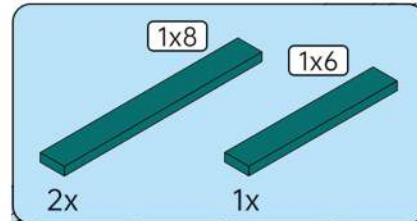
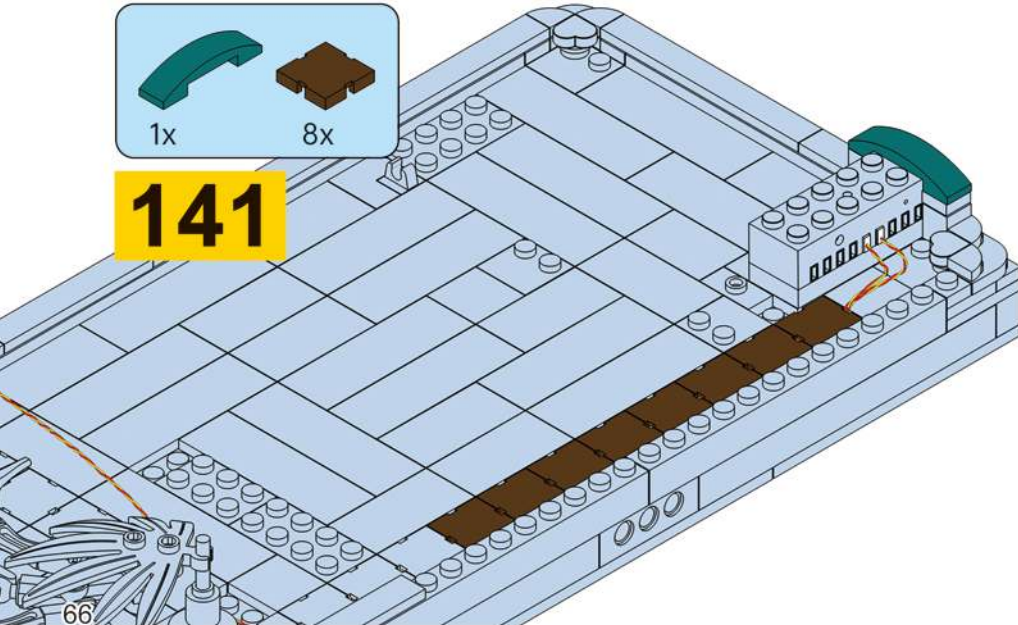

**142**

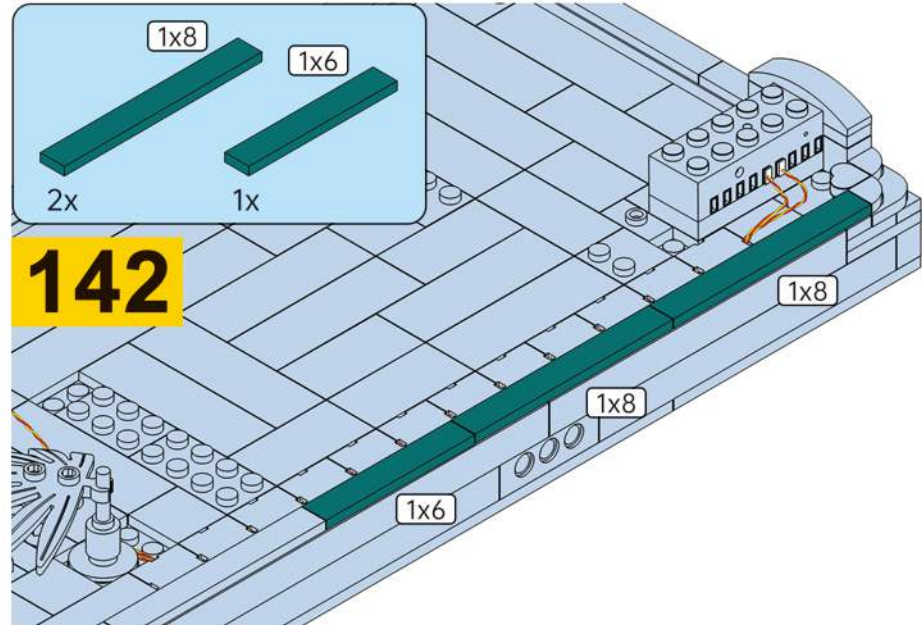

# JOY MAKES BRILLIANCE.

## Embrace Relaxation Embrace Joy

Every adultescent needs a "JOY BOX".  
Please, open your JOY BOX! Heading for joy.

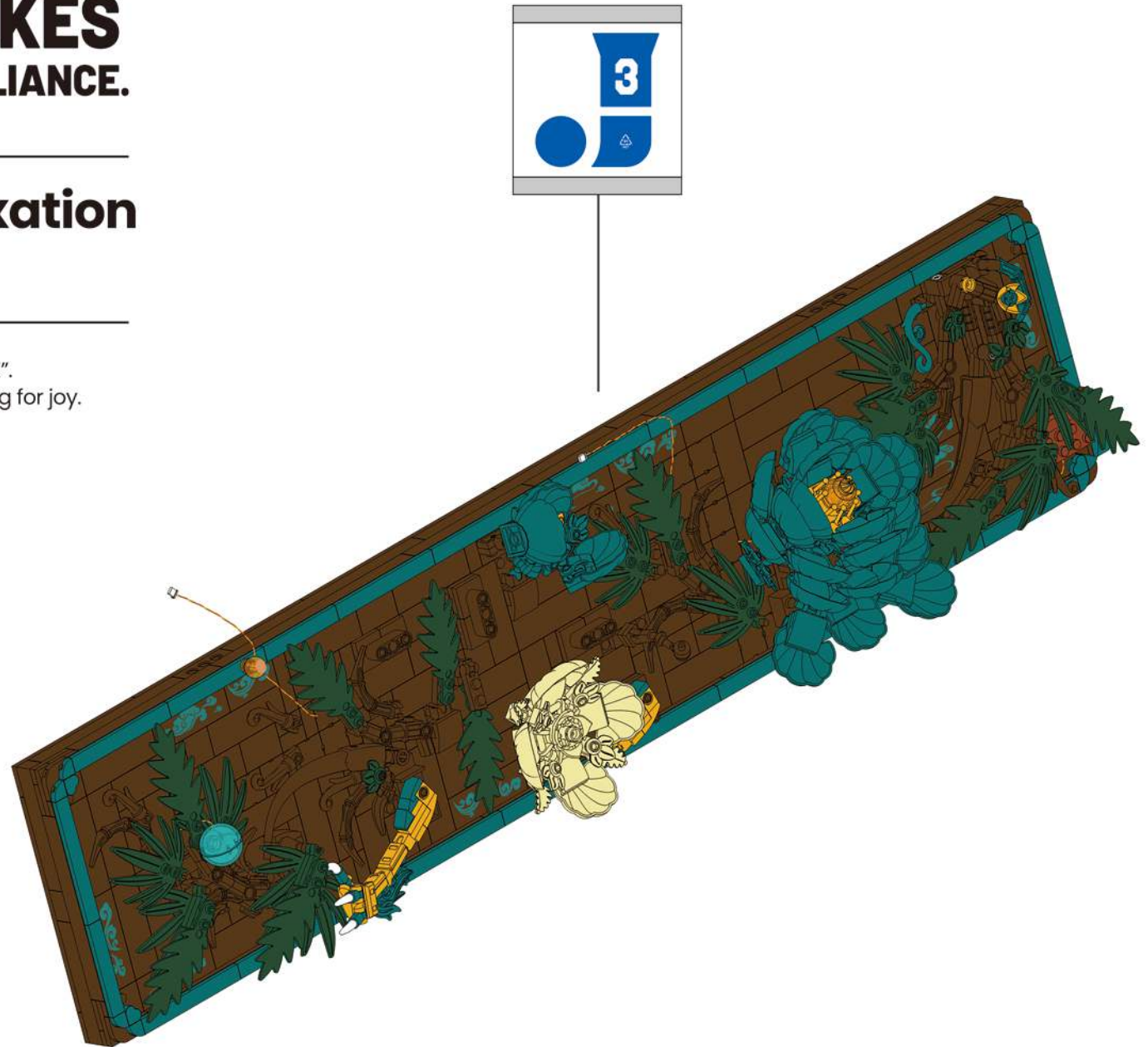

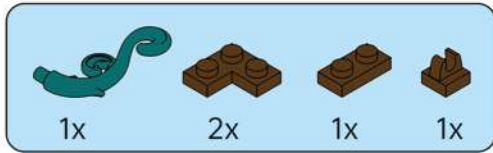

143

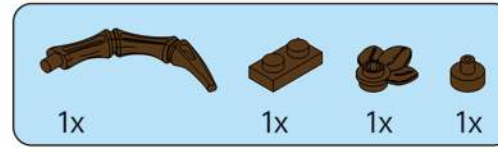
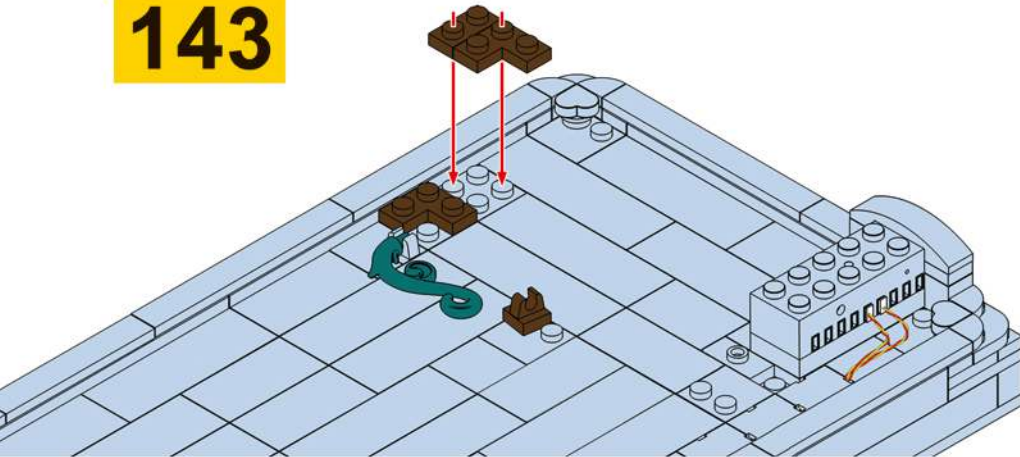

144

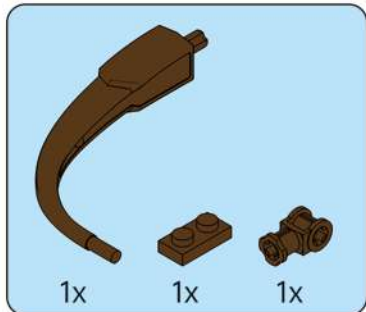
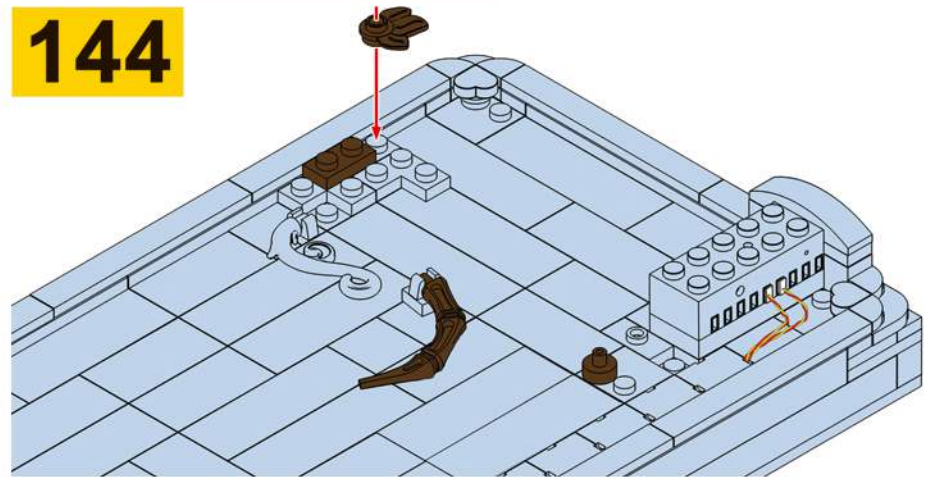

145

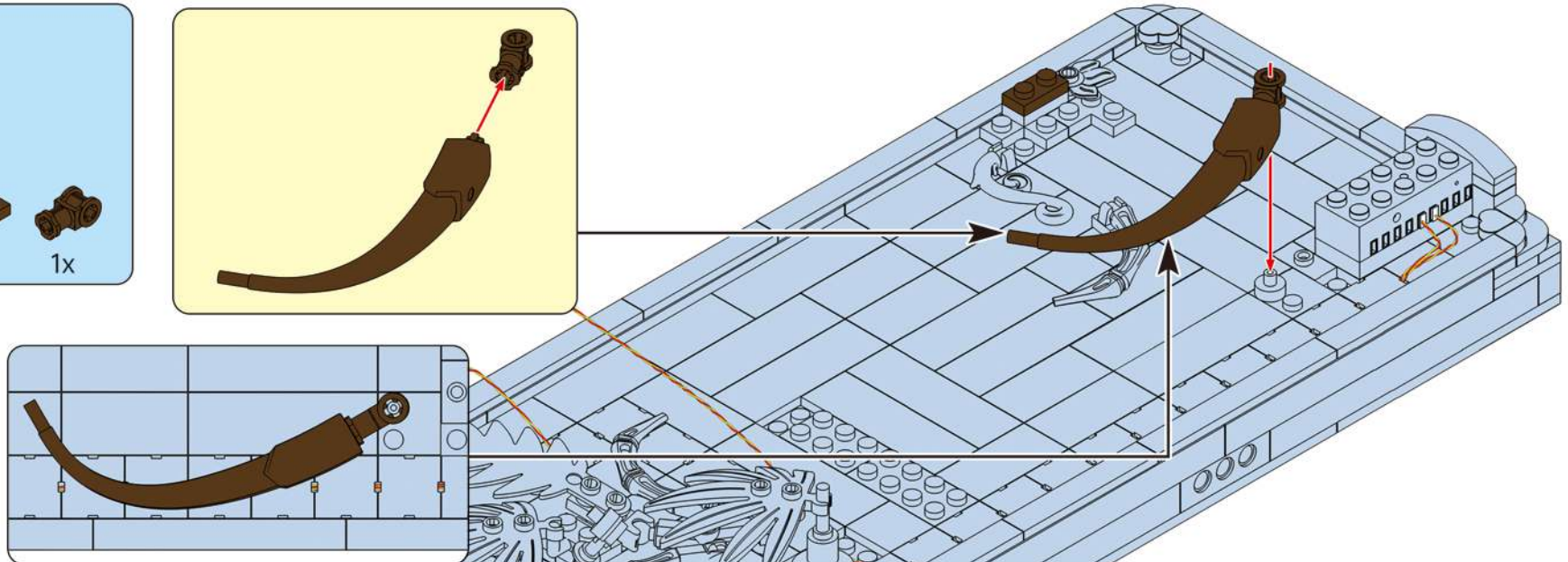

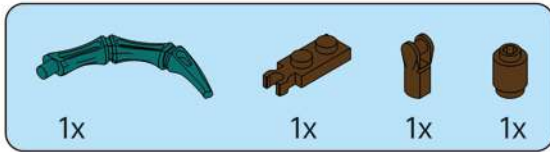

# 146

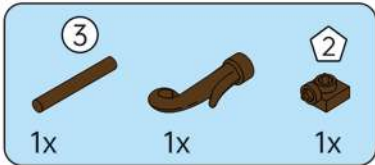
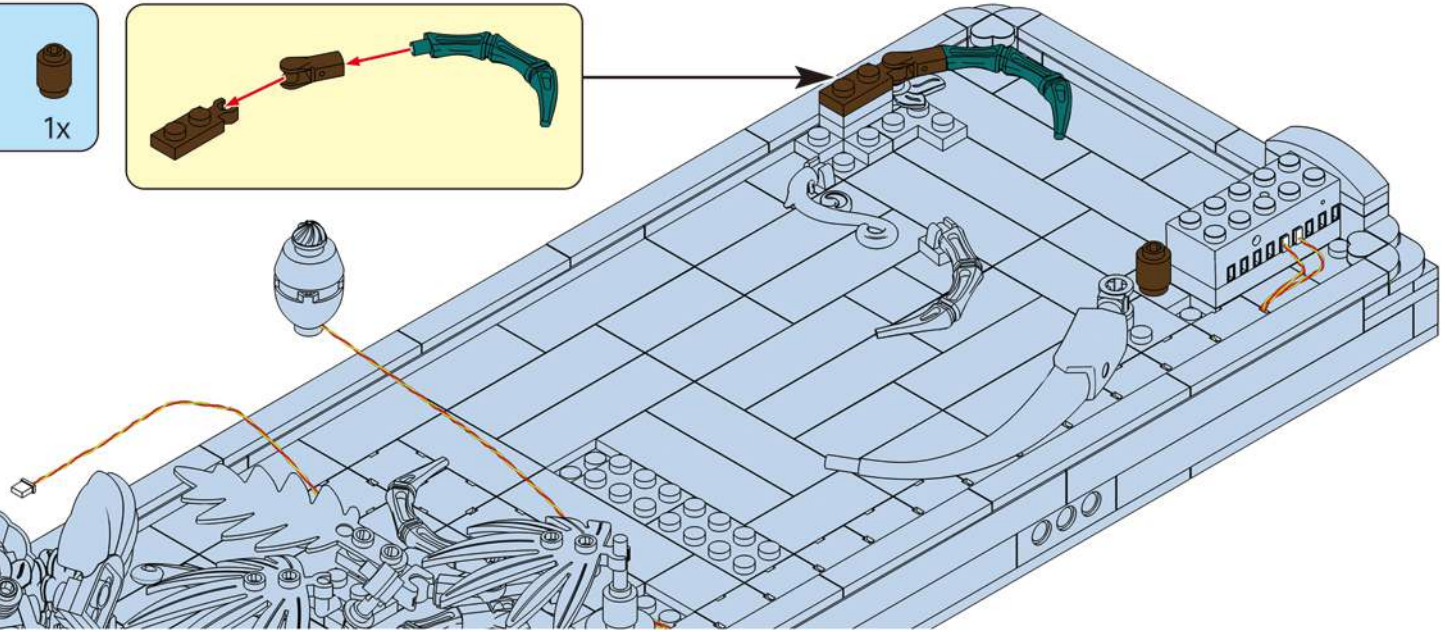
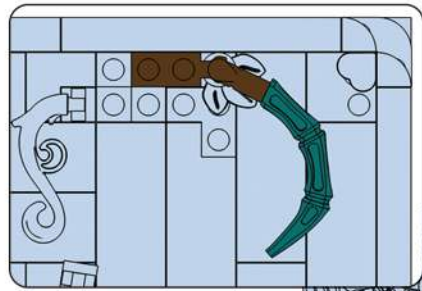
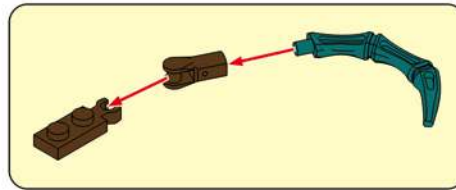

# 147

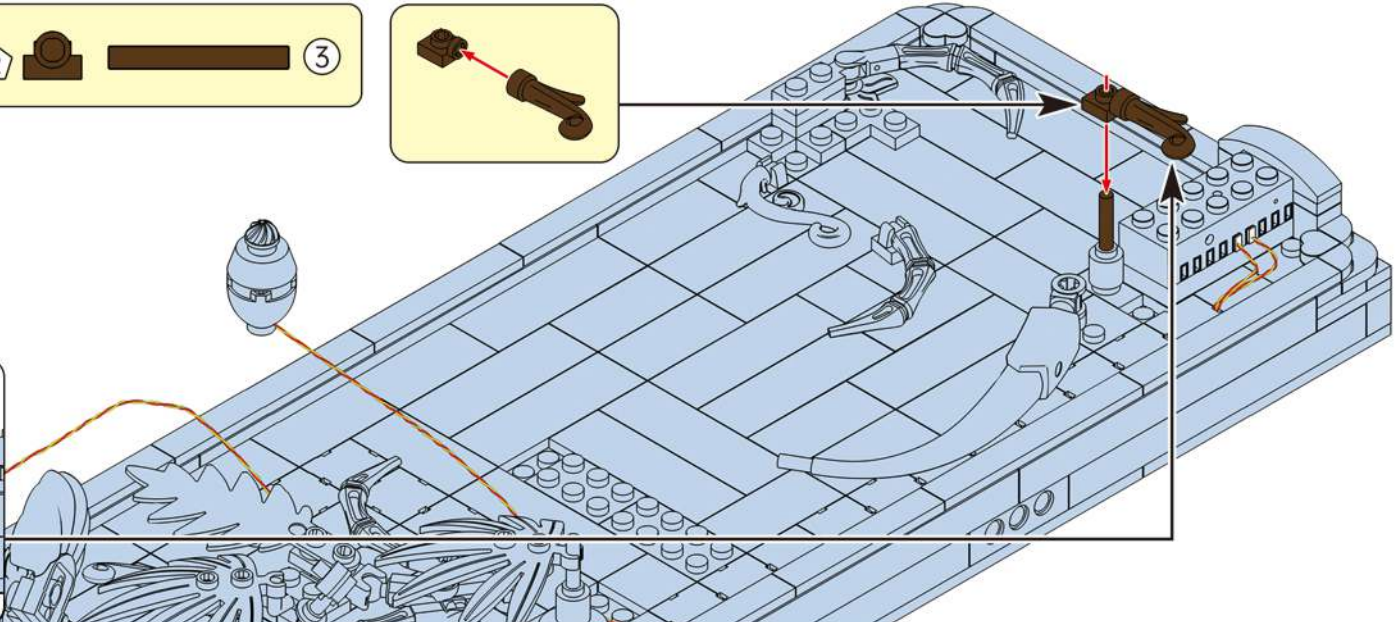
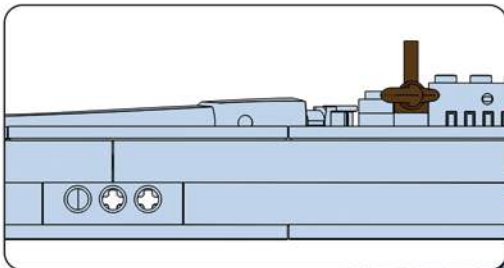
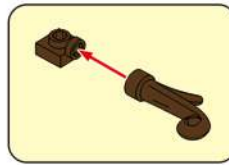
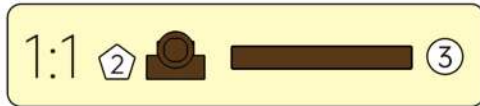

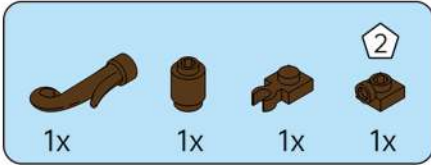

148

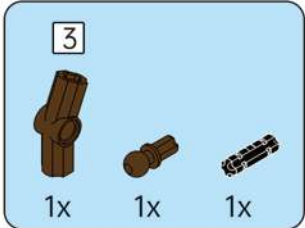
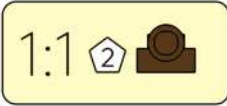
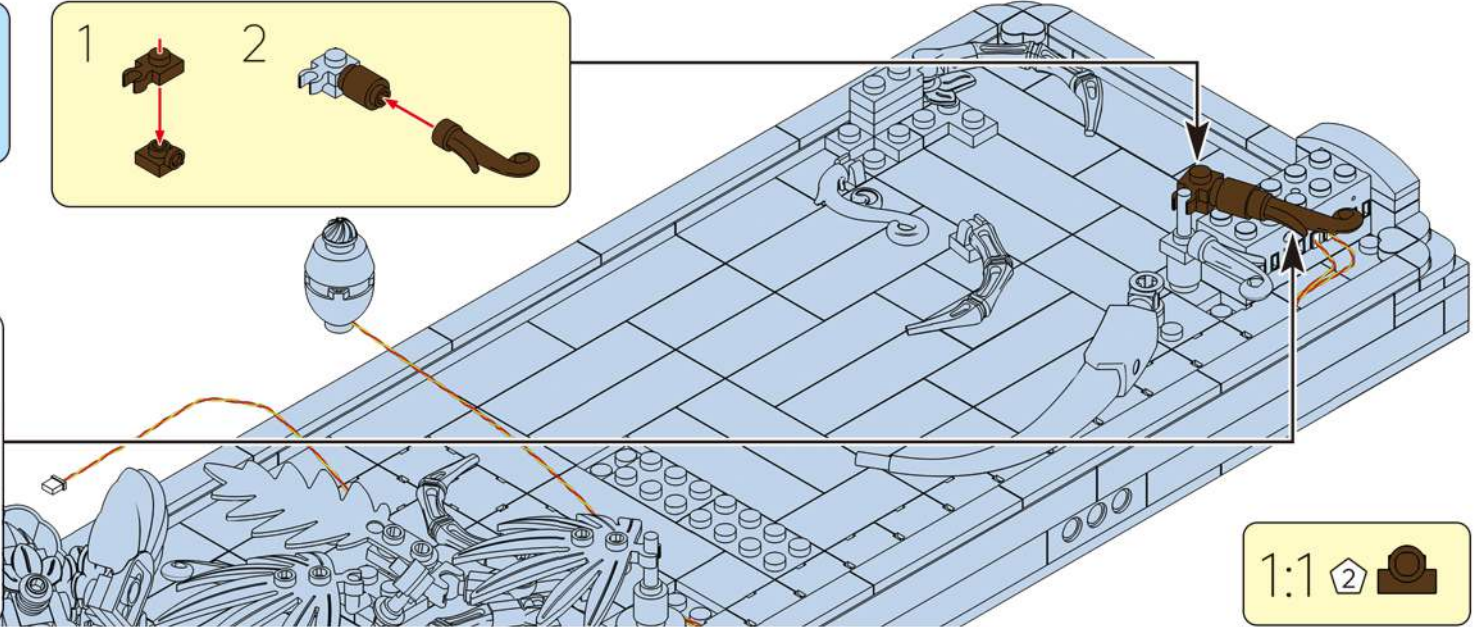
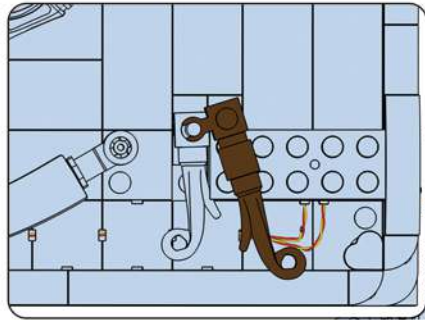
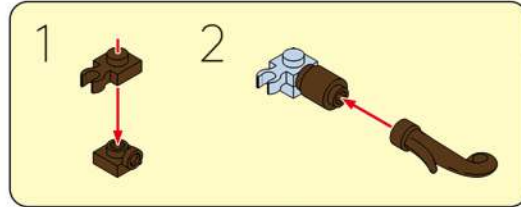

149

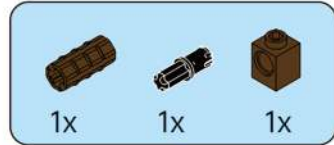
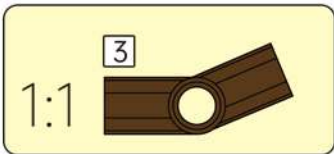

150

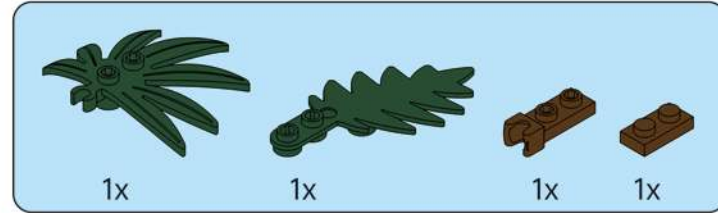
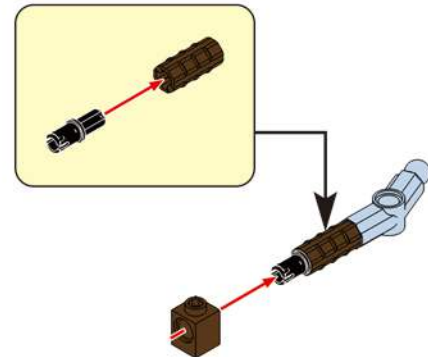

151

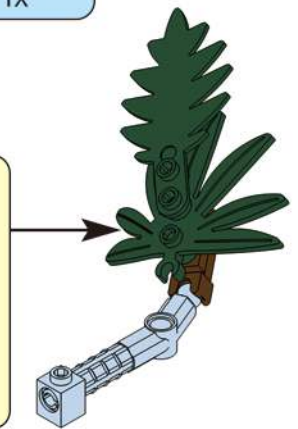
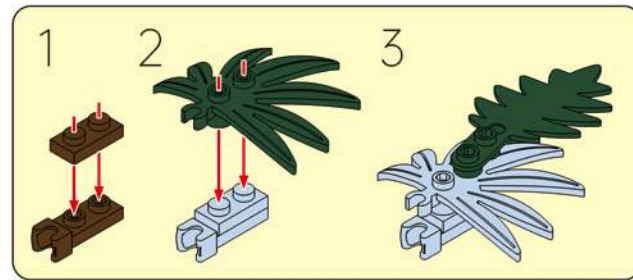

152

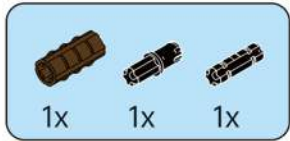
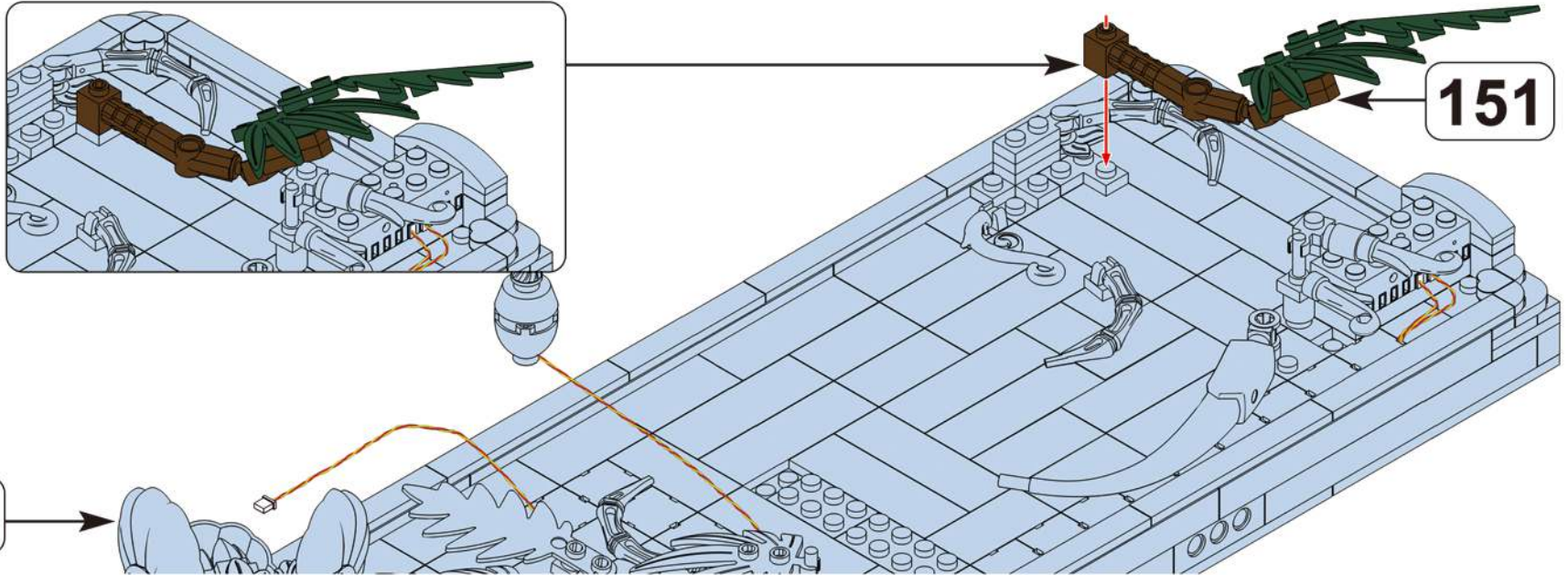

153

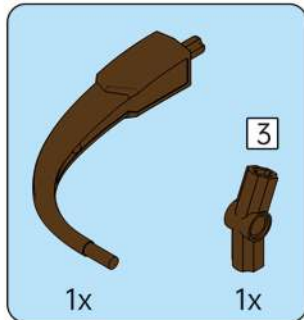
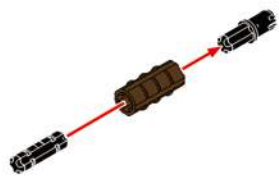

154

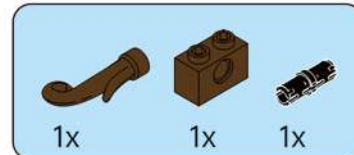
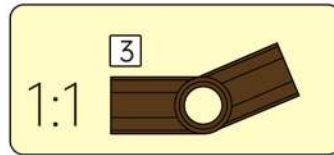

155

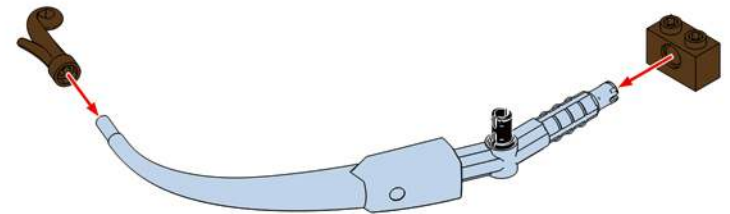

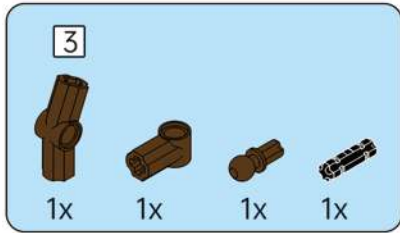

156

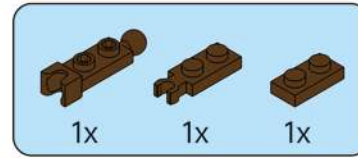
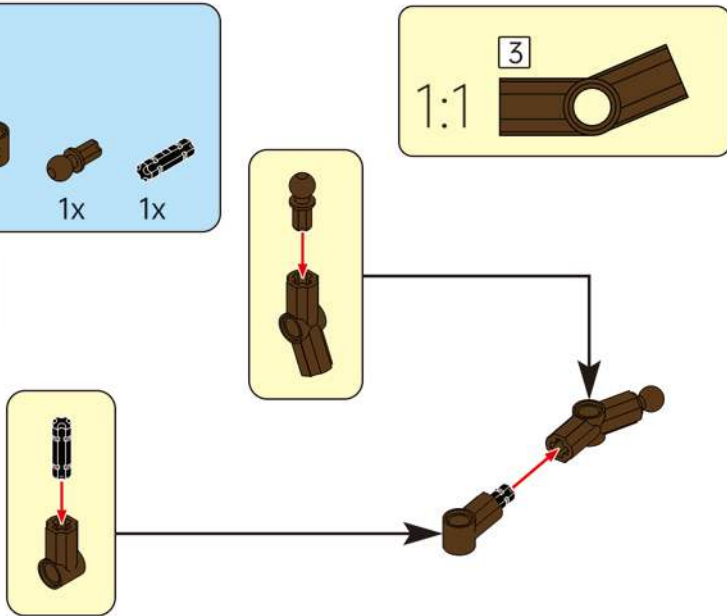

157

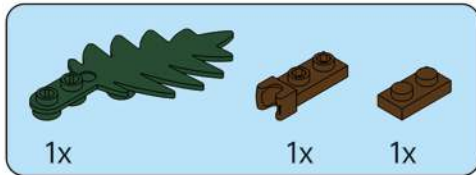
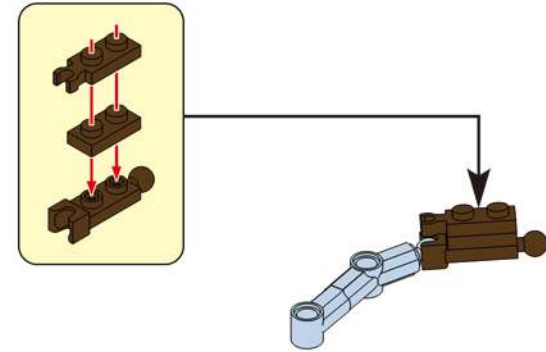

158

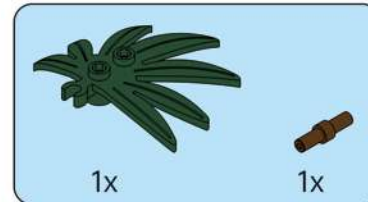
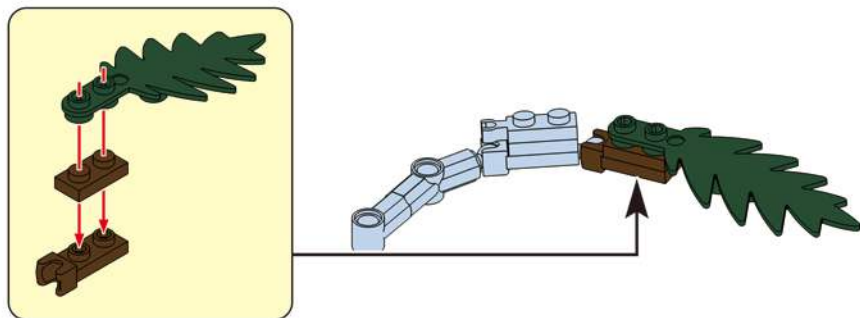

159

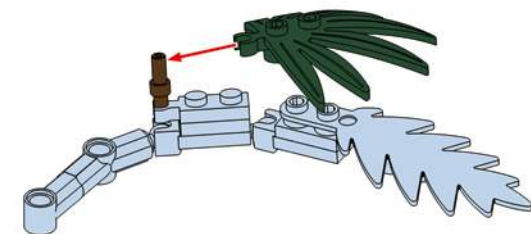

160

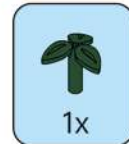
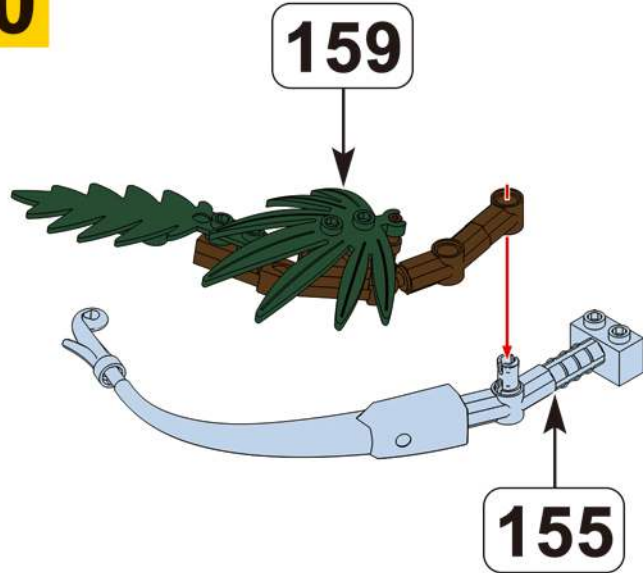

161

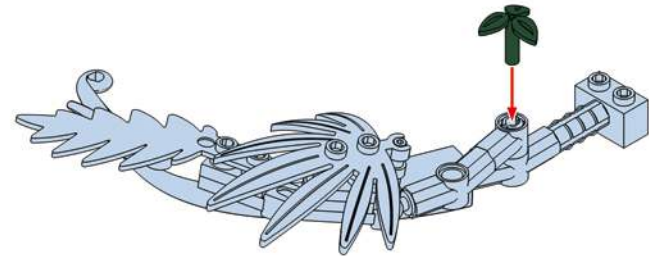

162

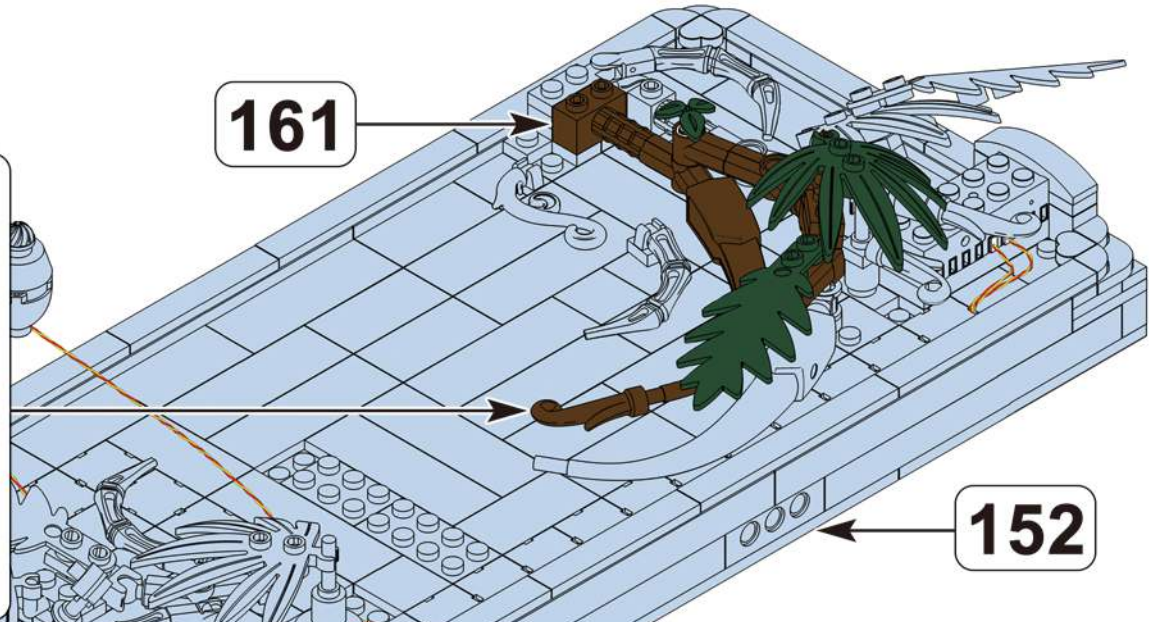
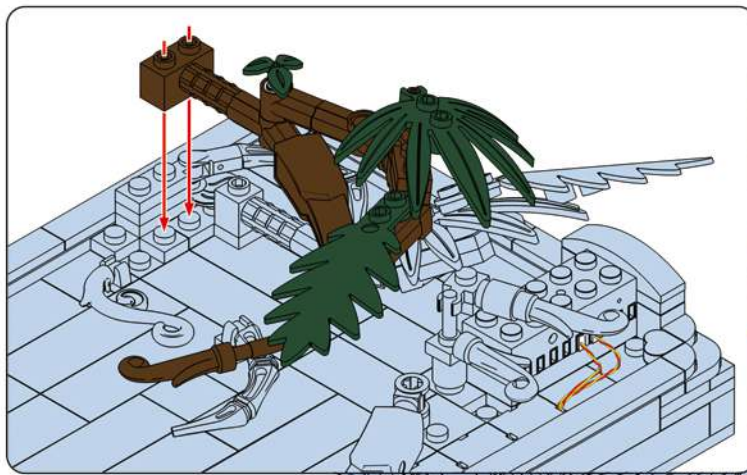

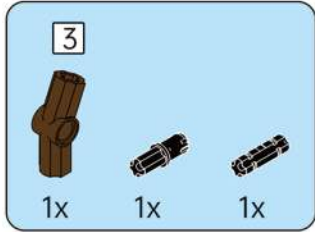

**163**

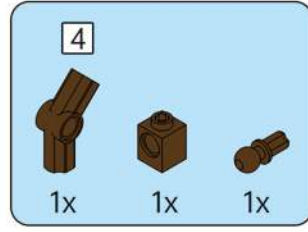
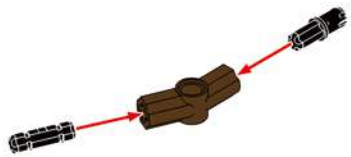

**164**

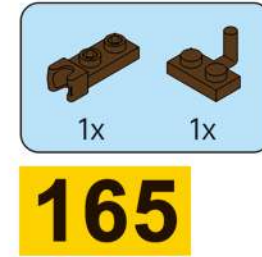
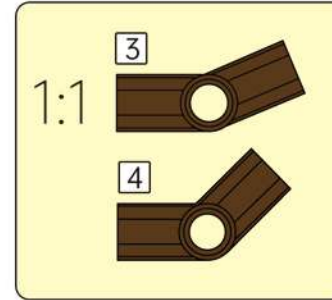
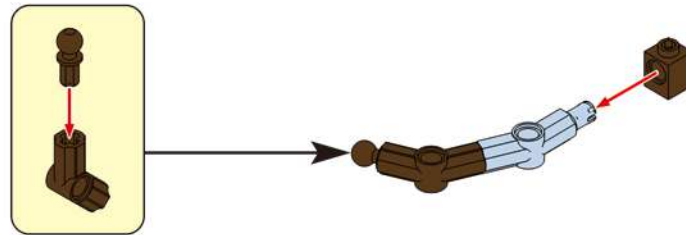

**165**

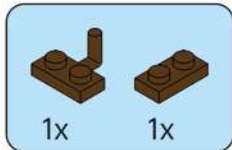
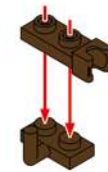

**166**

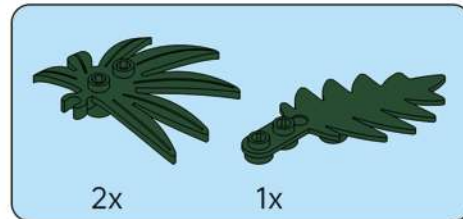
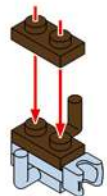

**167**

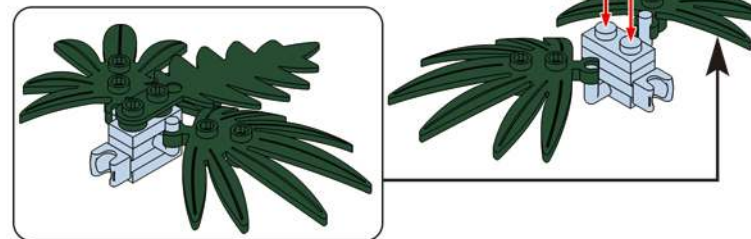

**168**

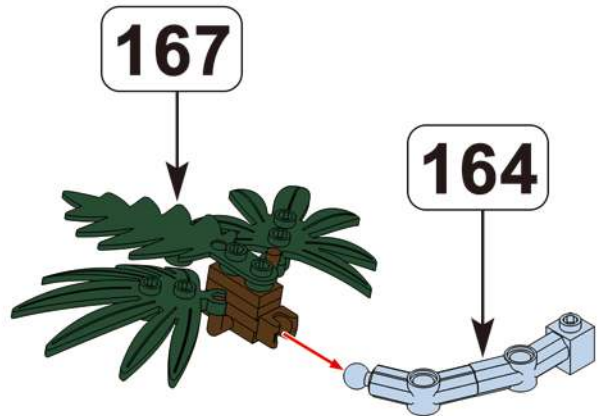

169

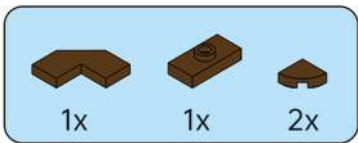
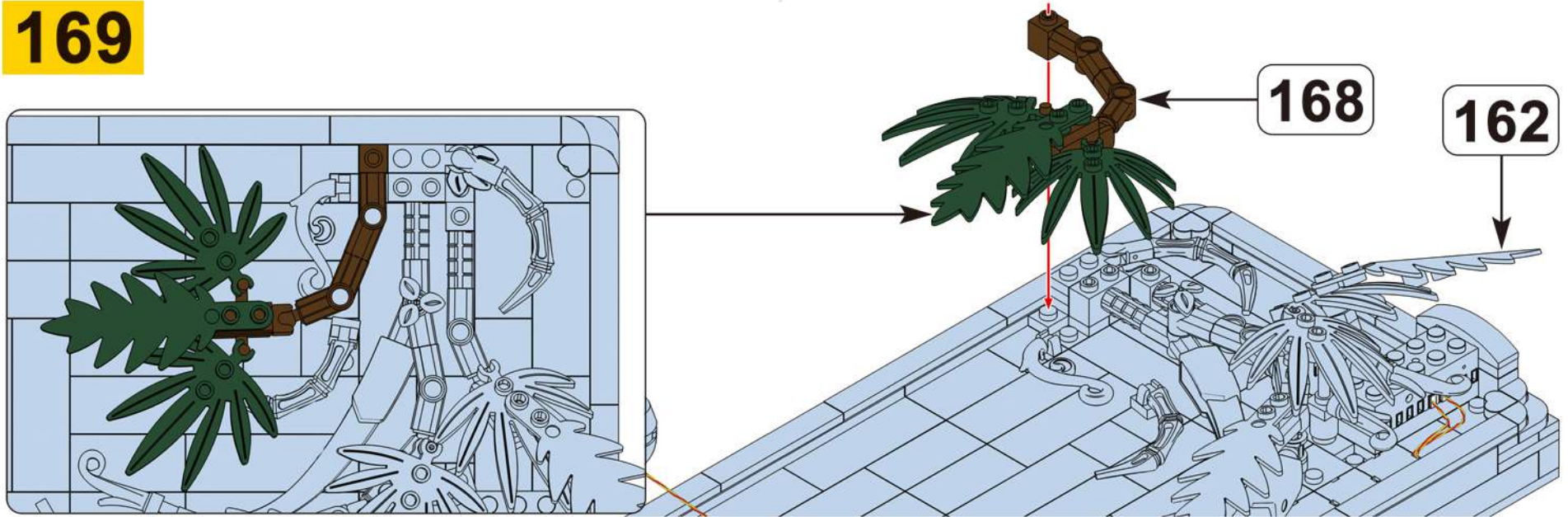

170

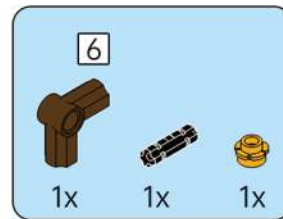
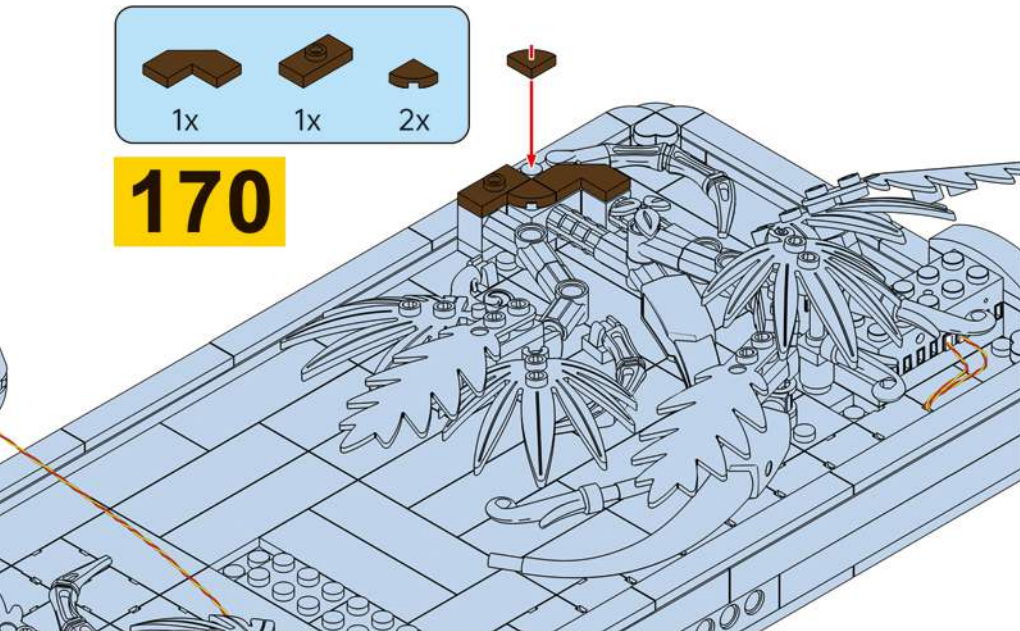

171

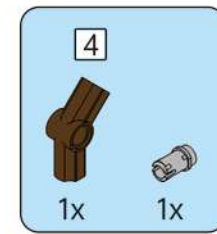
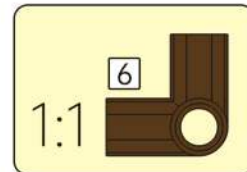

172

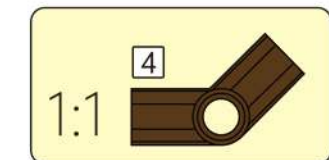



173

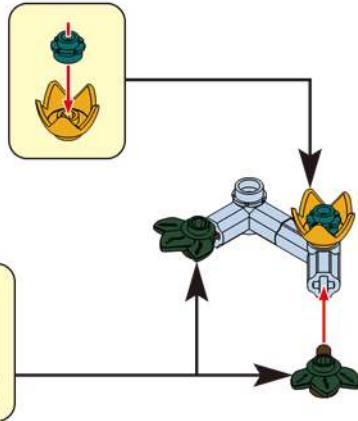

174

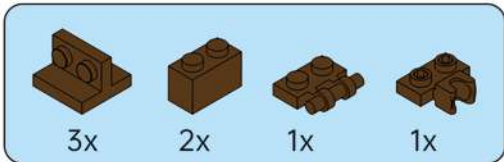
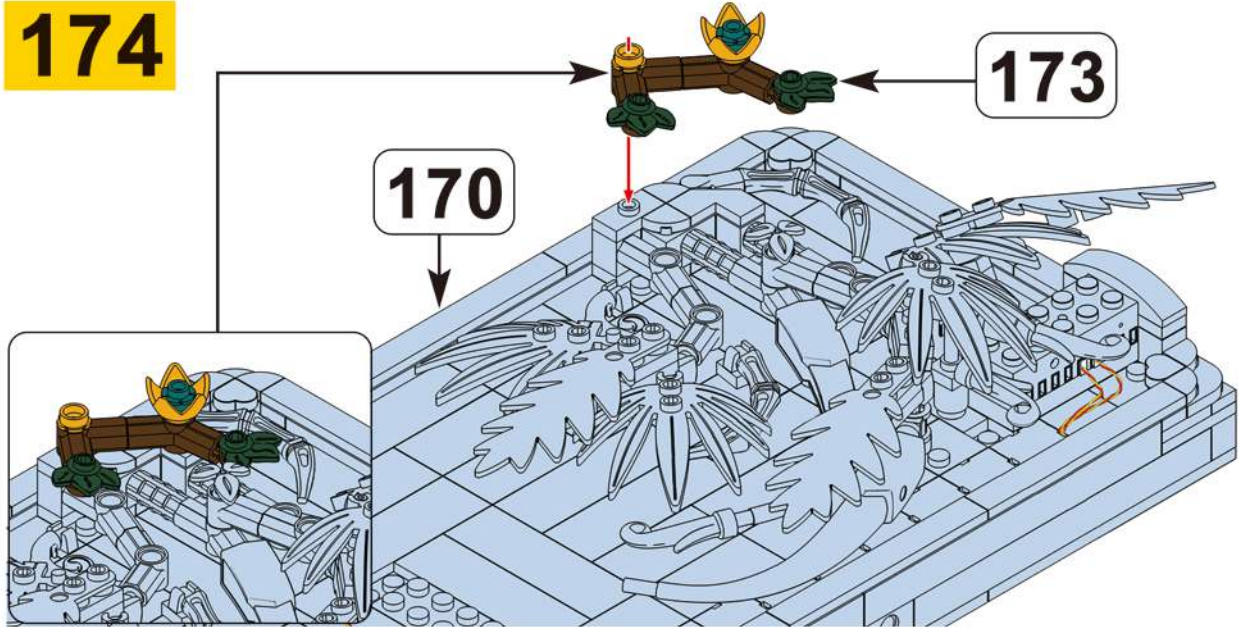

175

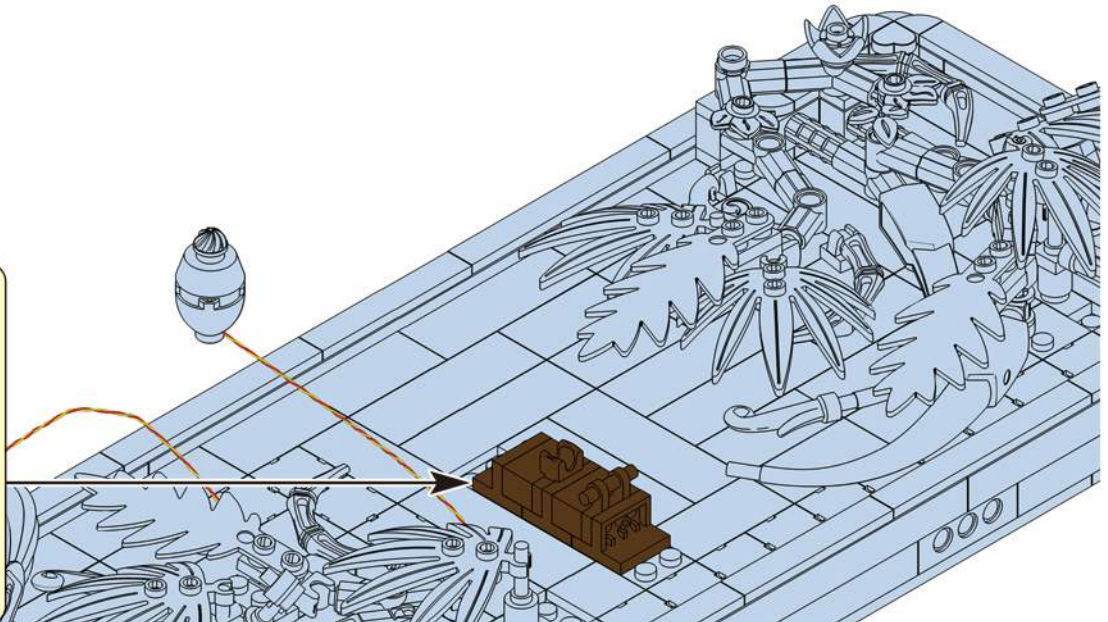
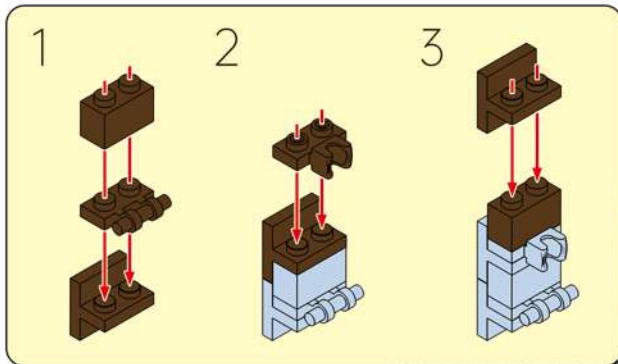

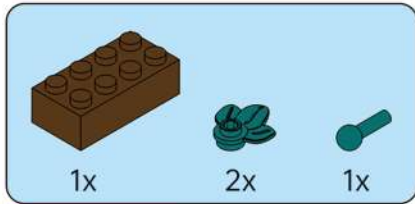

176

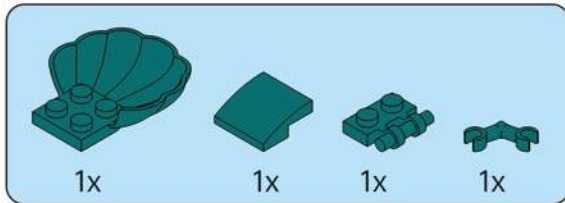
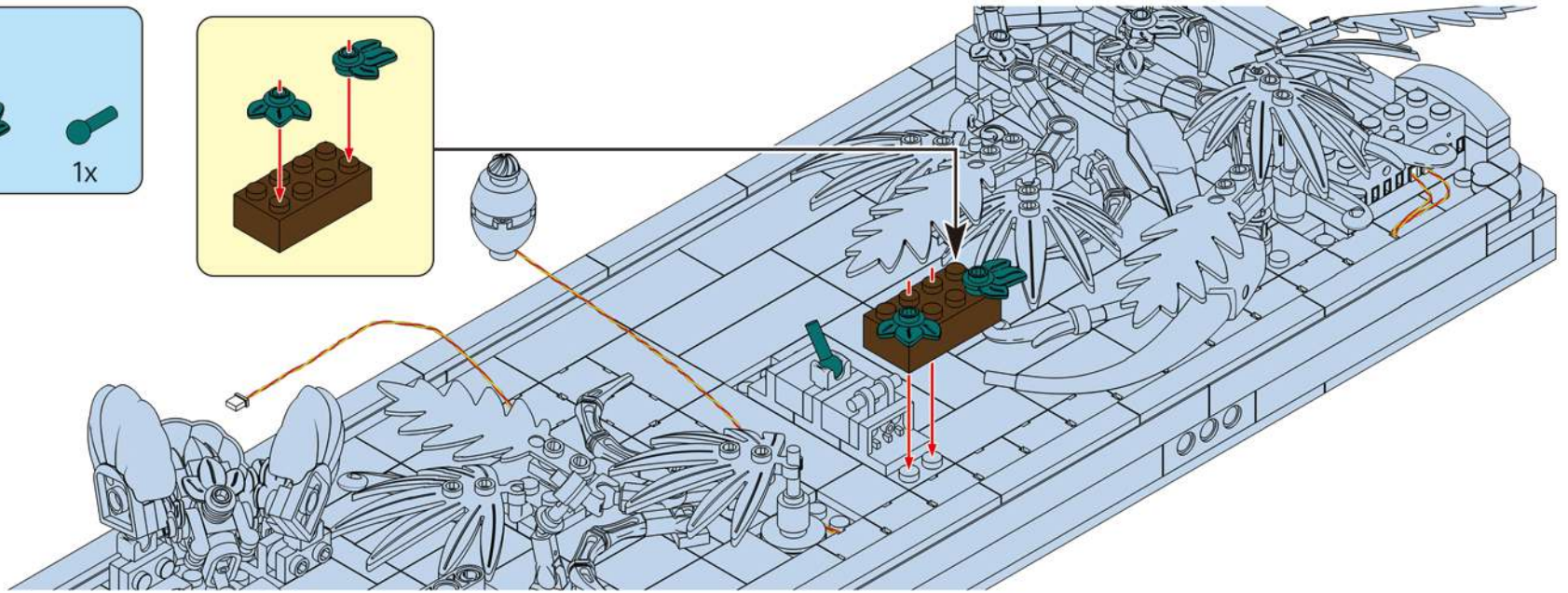
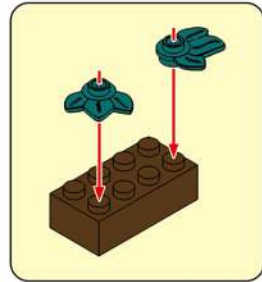

177

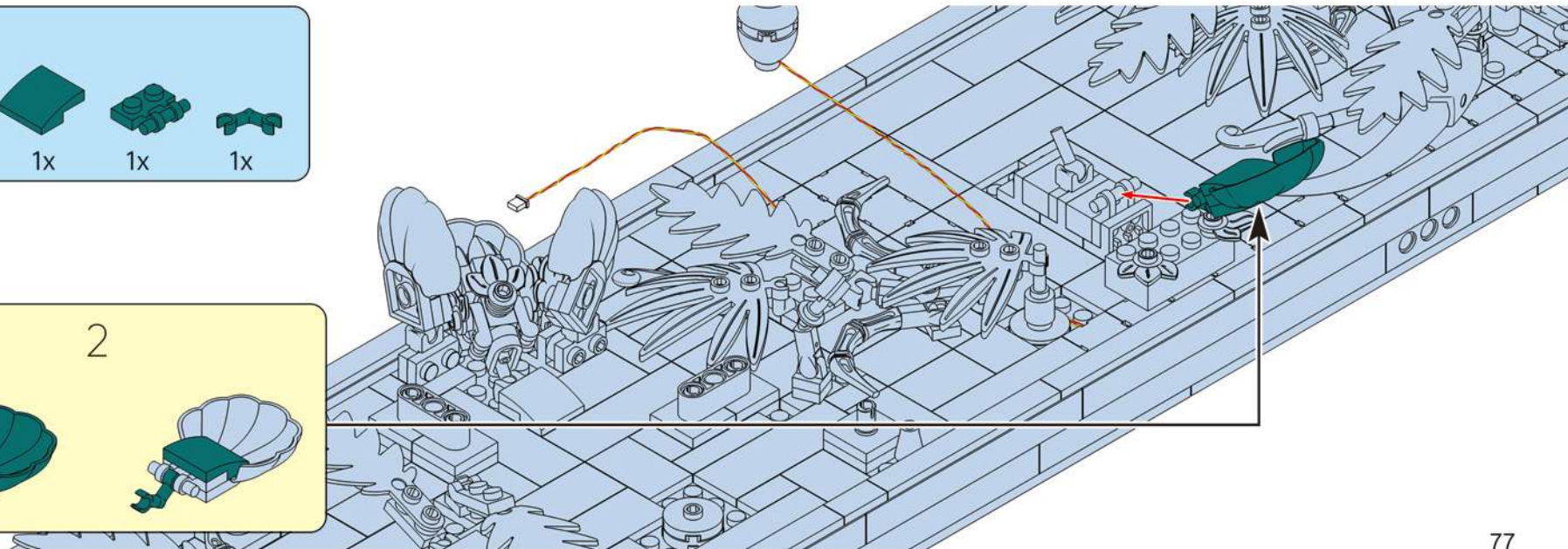
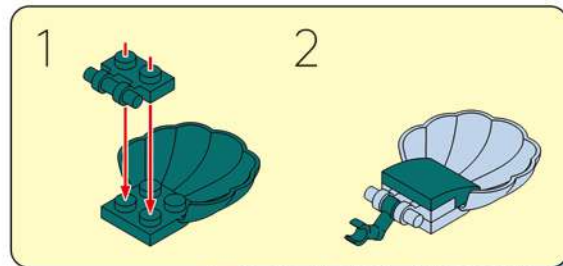

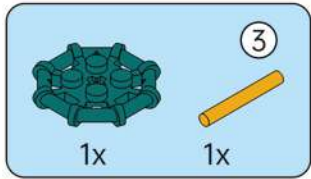

**178**

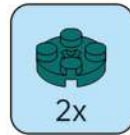
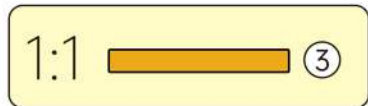
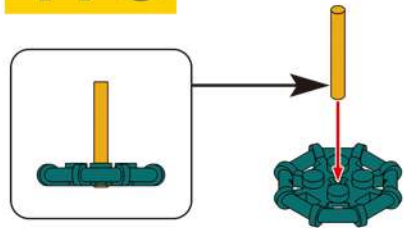

**179**

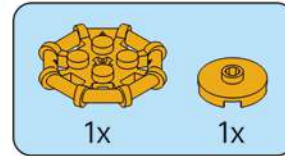
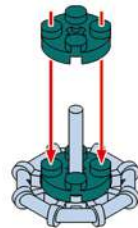

**180**

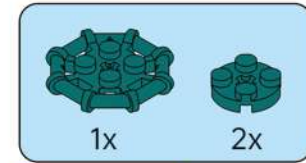
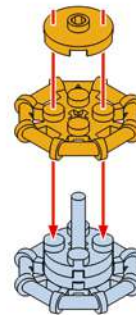

**181**

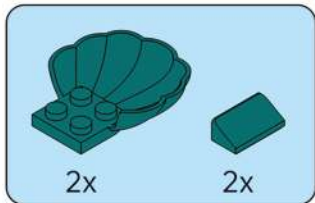
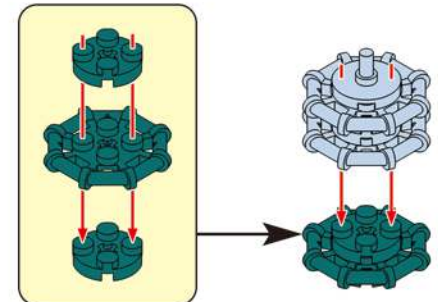

**182**

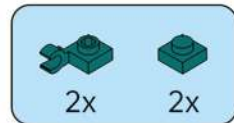
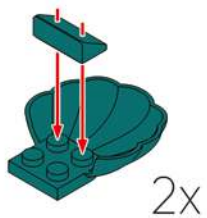

**183**

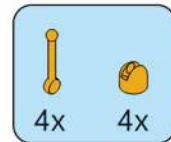
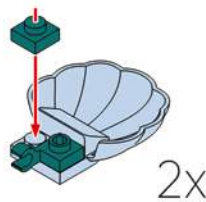

**184**

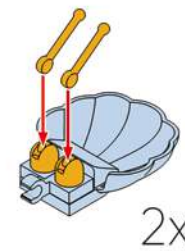

**185**



**181**

**184**

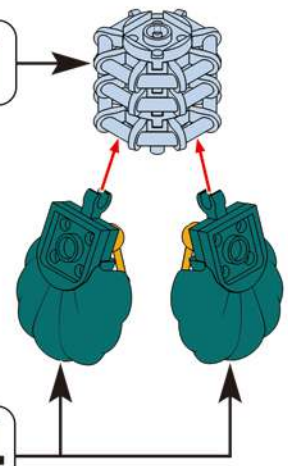

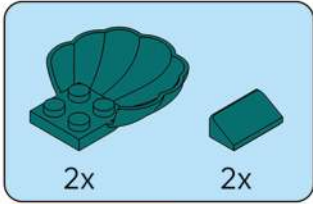

186

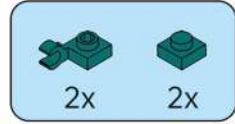
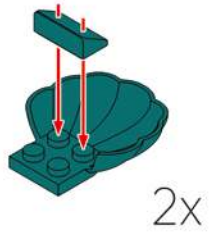

187

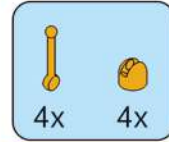
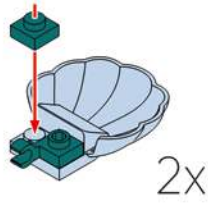

188

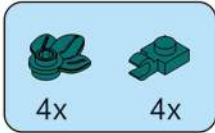
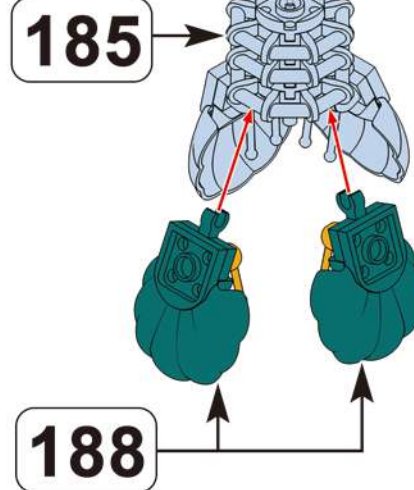
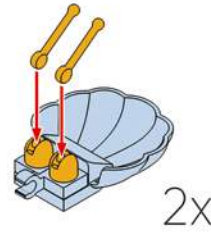

190

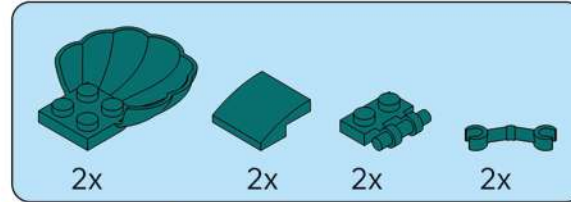
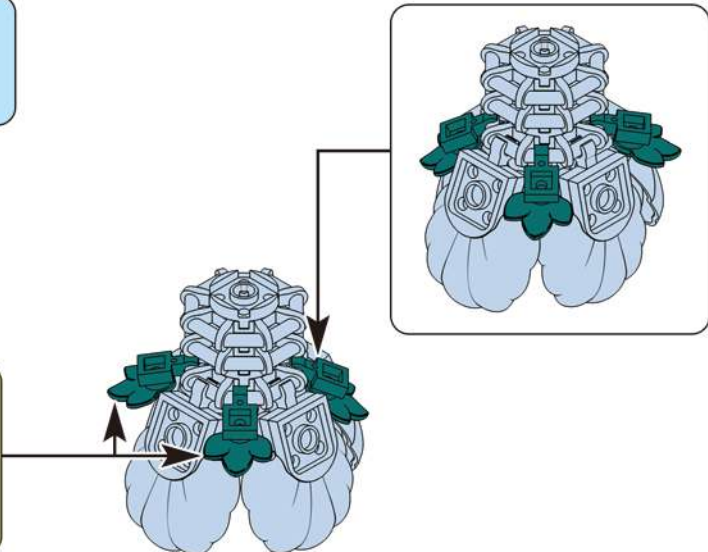
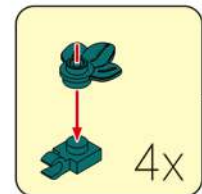

191

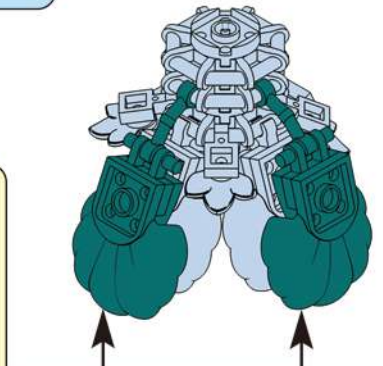
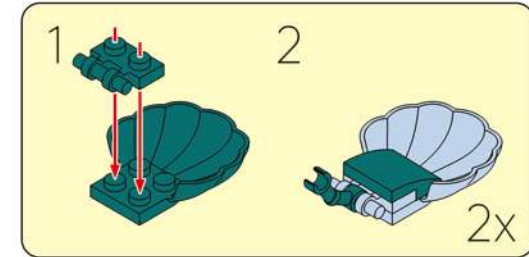

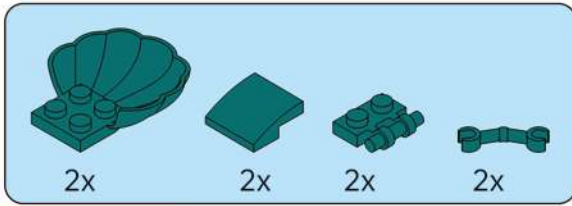

192

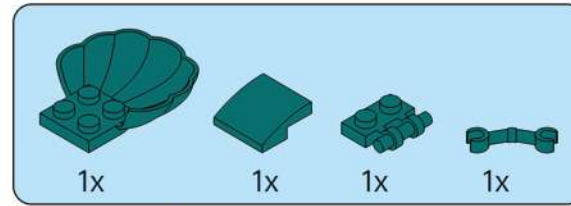
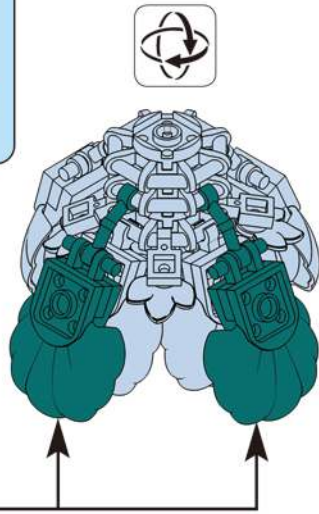
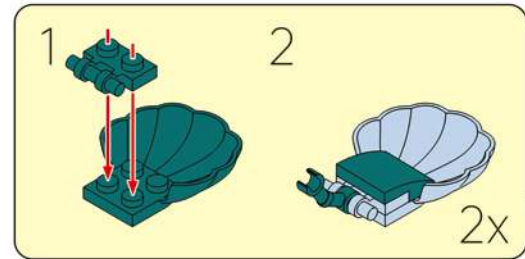

193

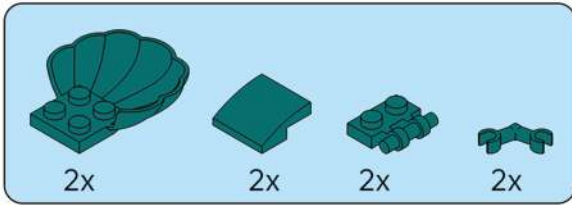
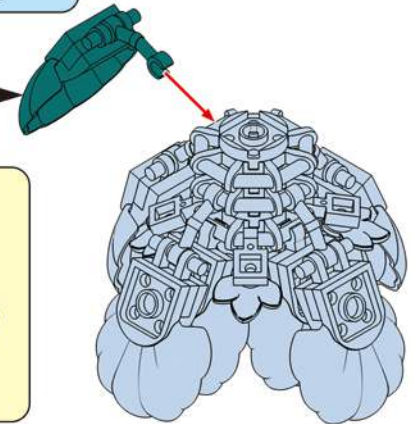
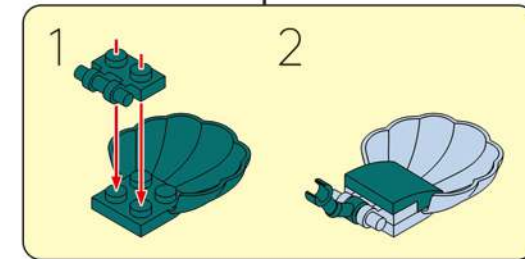

194

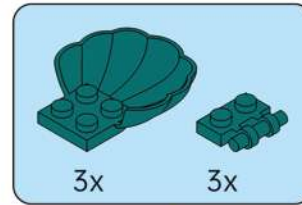
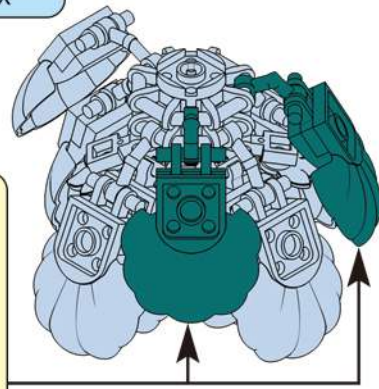
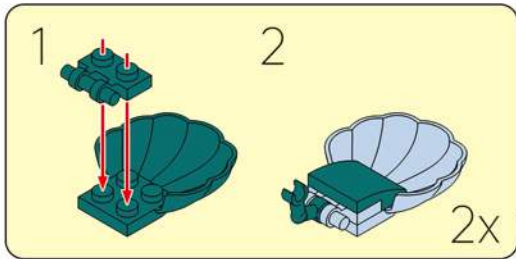

195

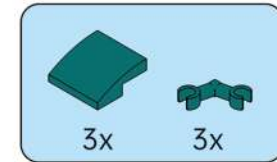
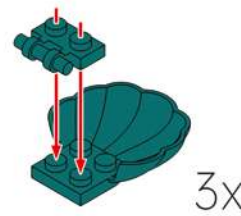

196

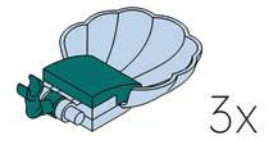

197

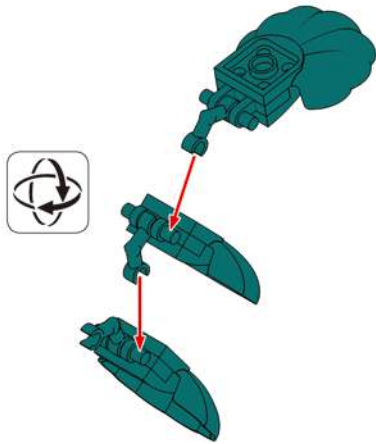

198

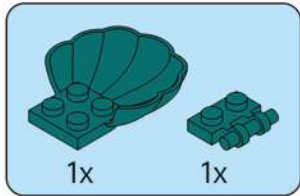
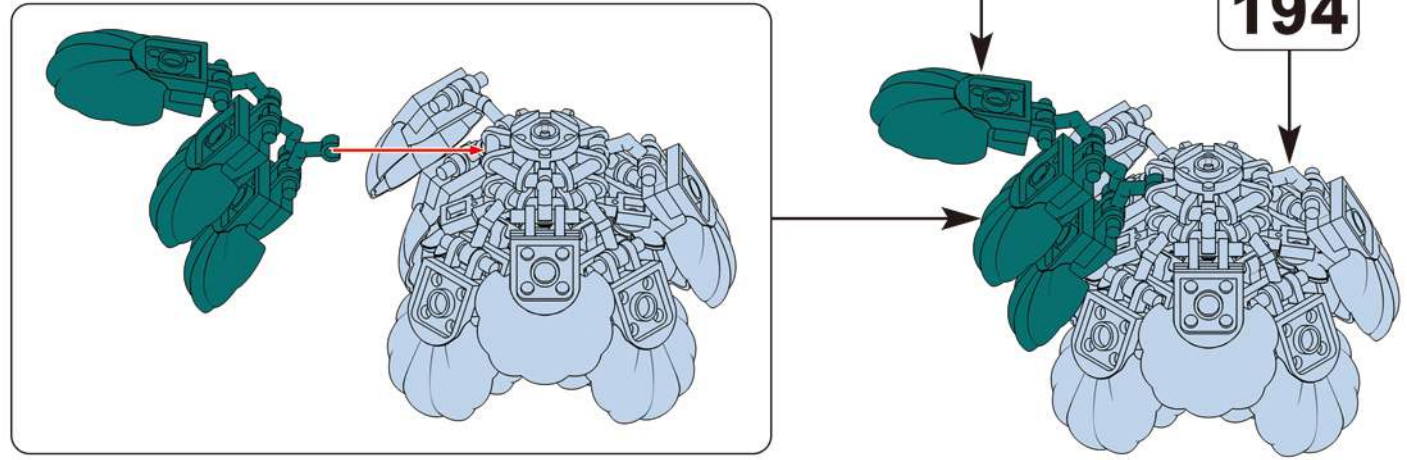

199

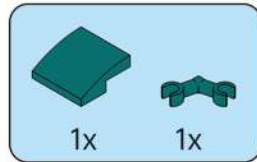
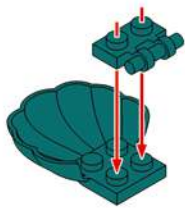

200



201

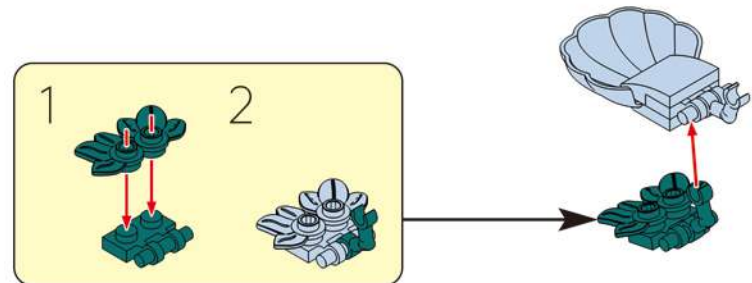

202

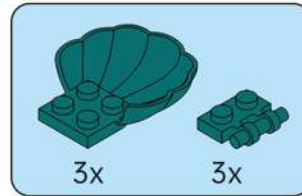
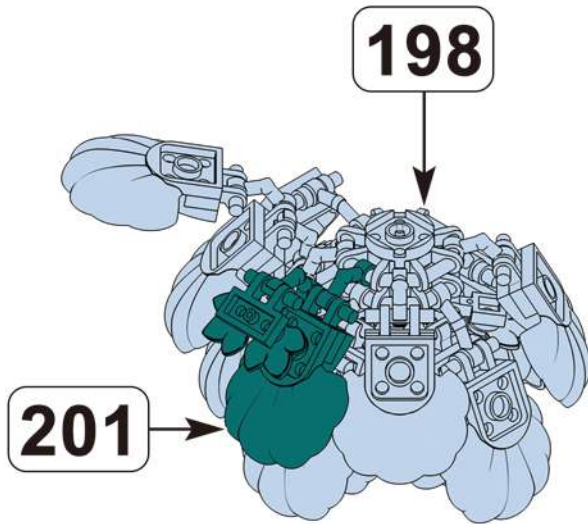

203

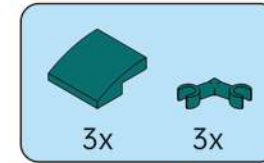
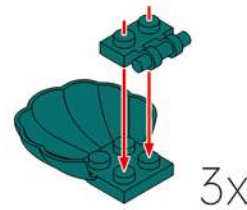

204



205

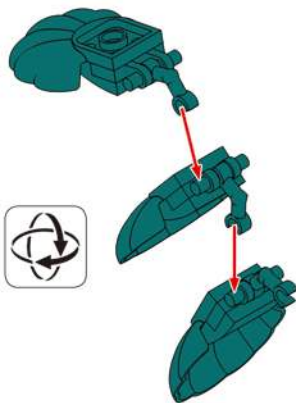

206

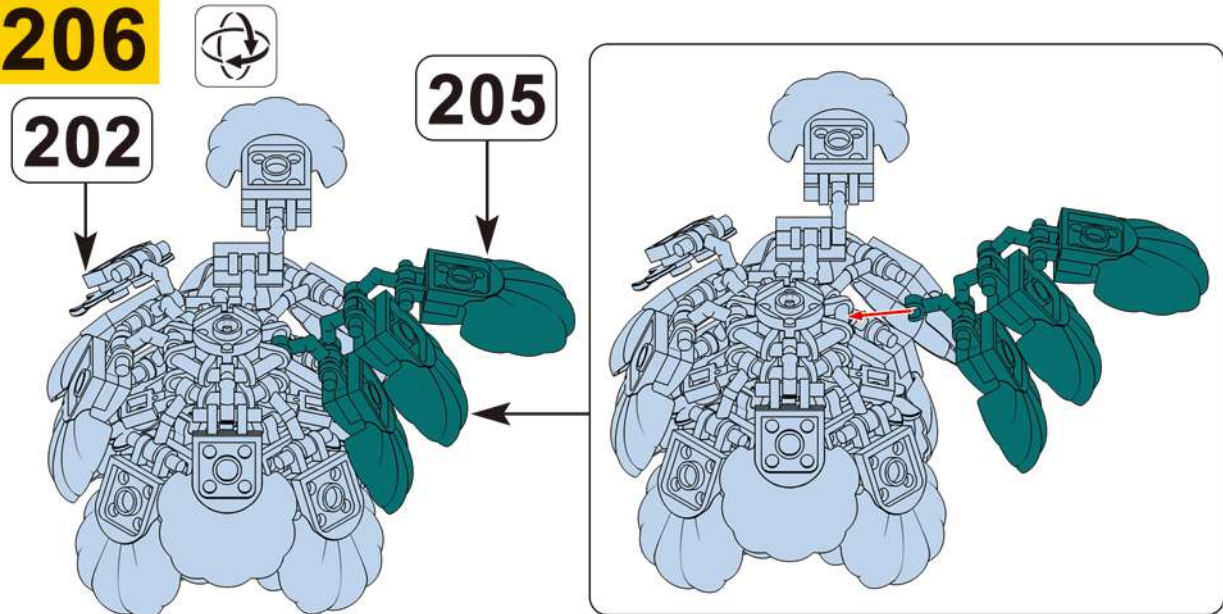

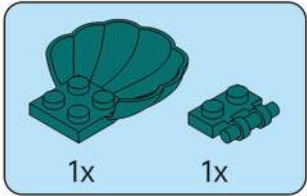

**207**

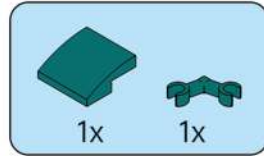
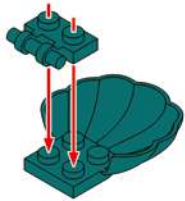

**208**

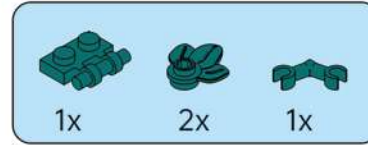

**209**

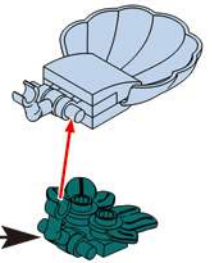
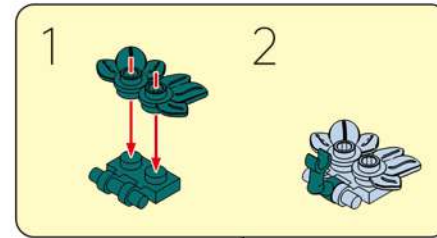

**210**

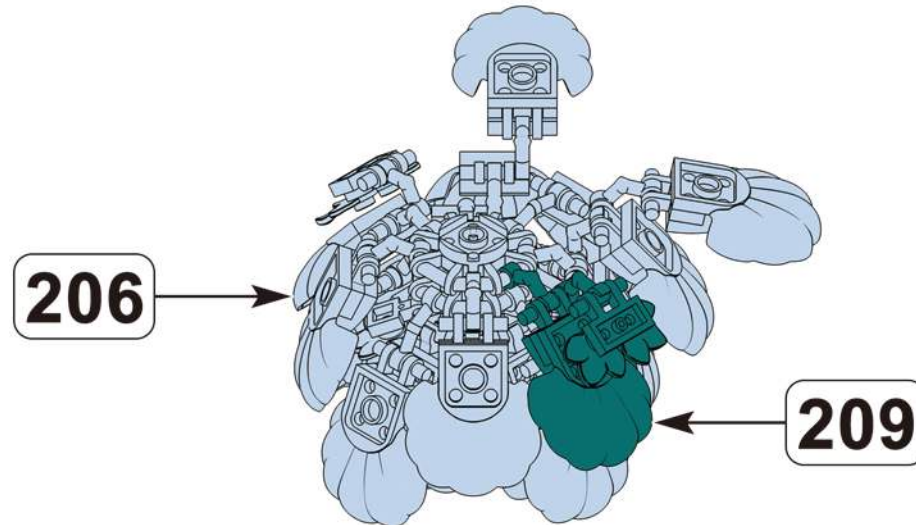

# 211

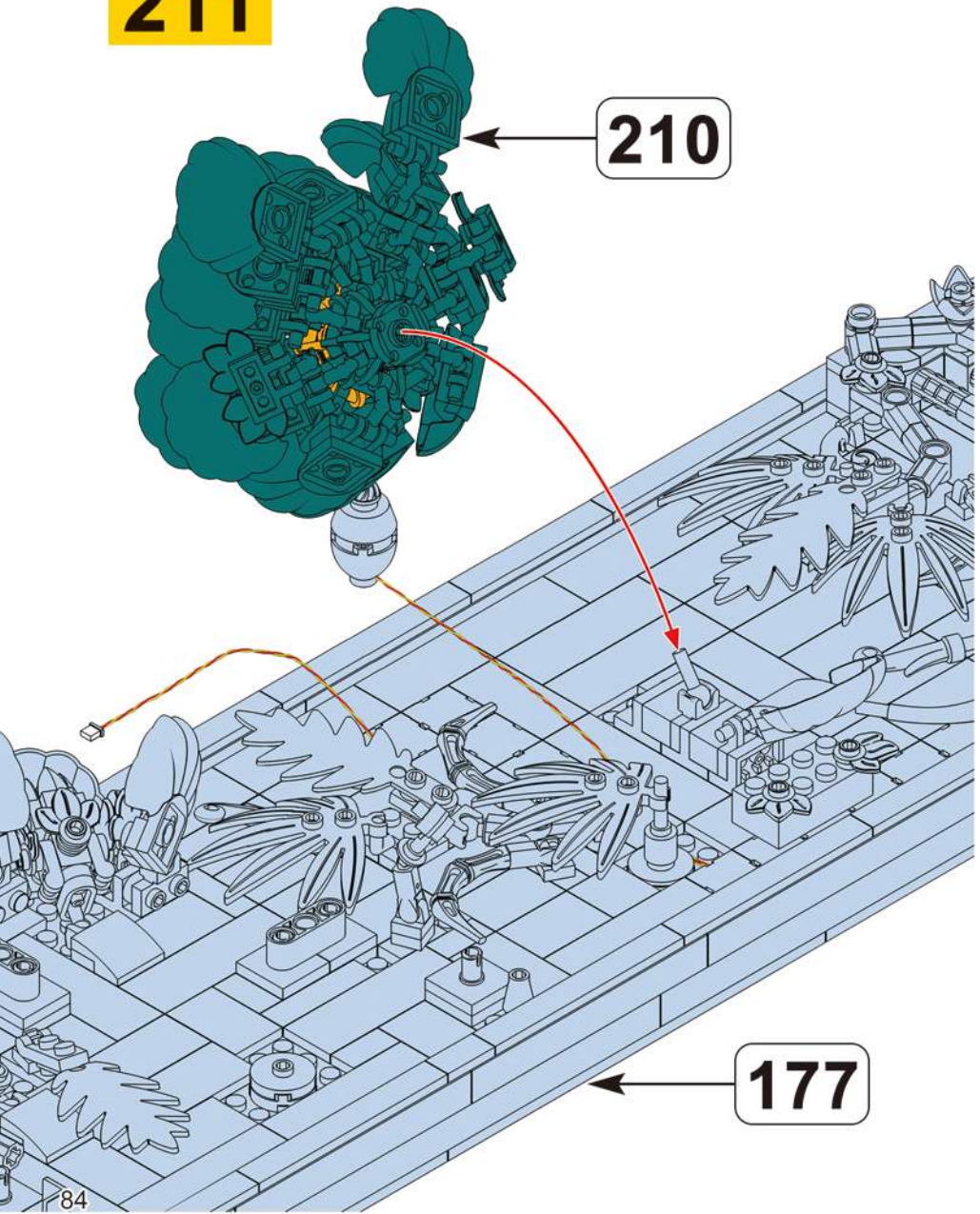

# 212

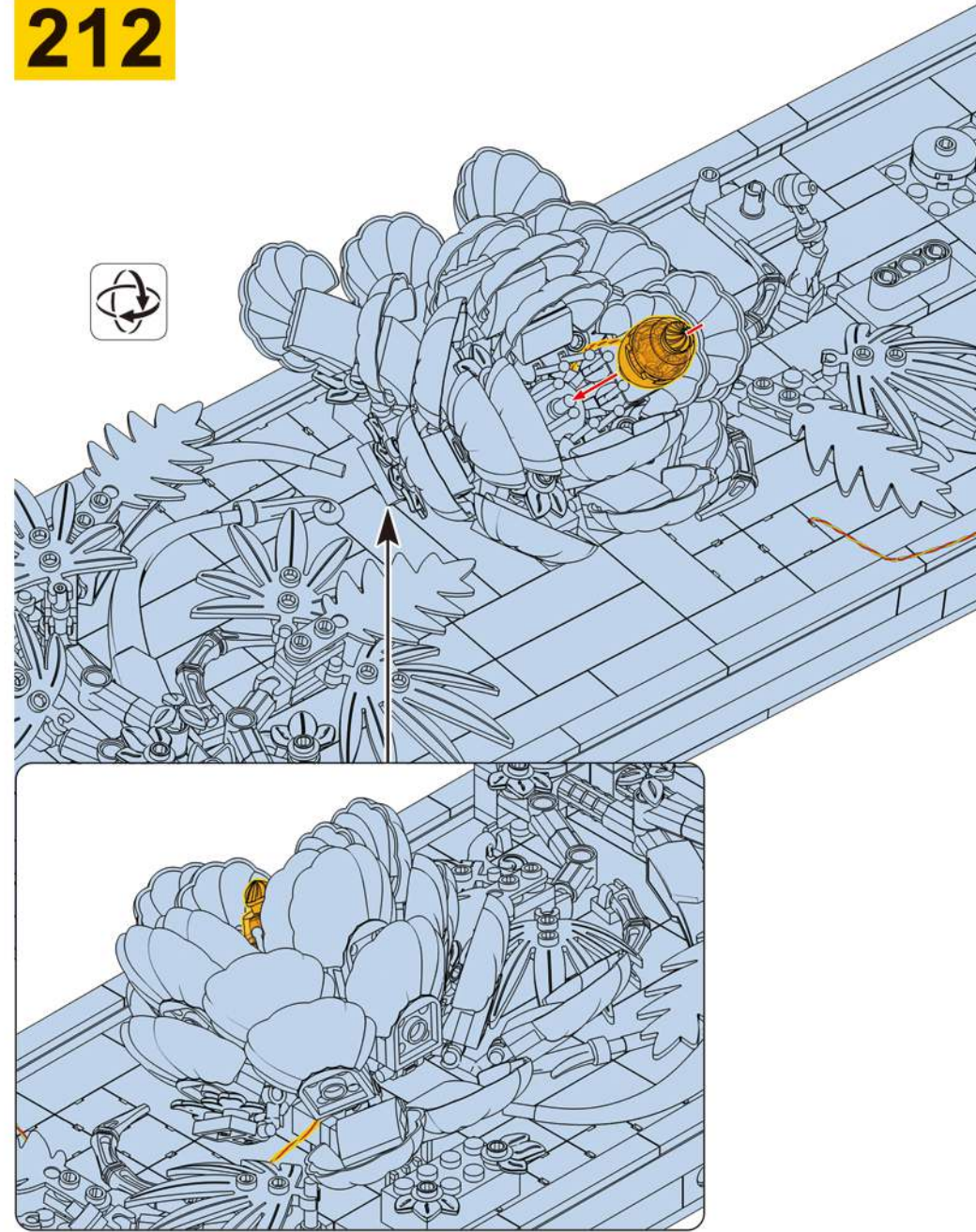

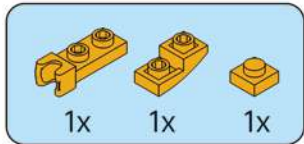

**213**

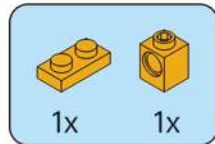
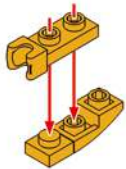

**214**

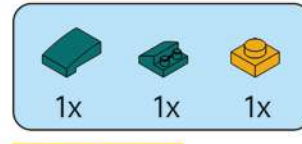
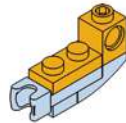

**215**

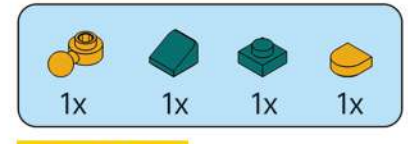
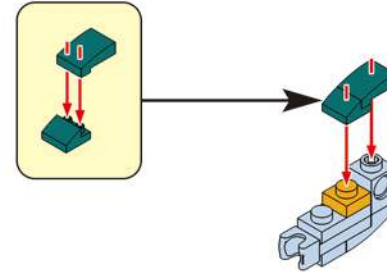

**216**

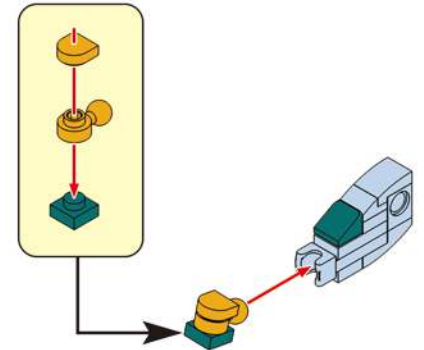

**217**

**212**

**216**

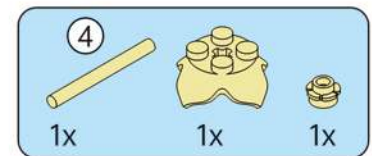
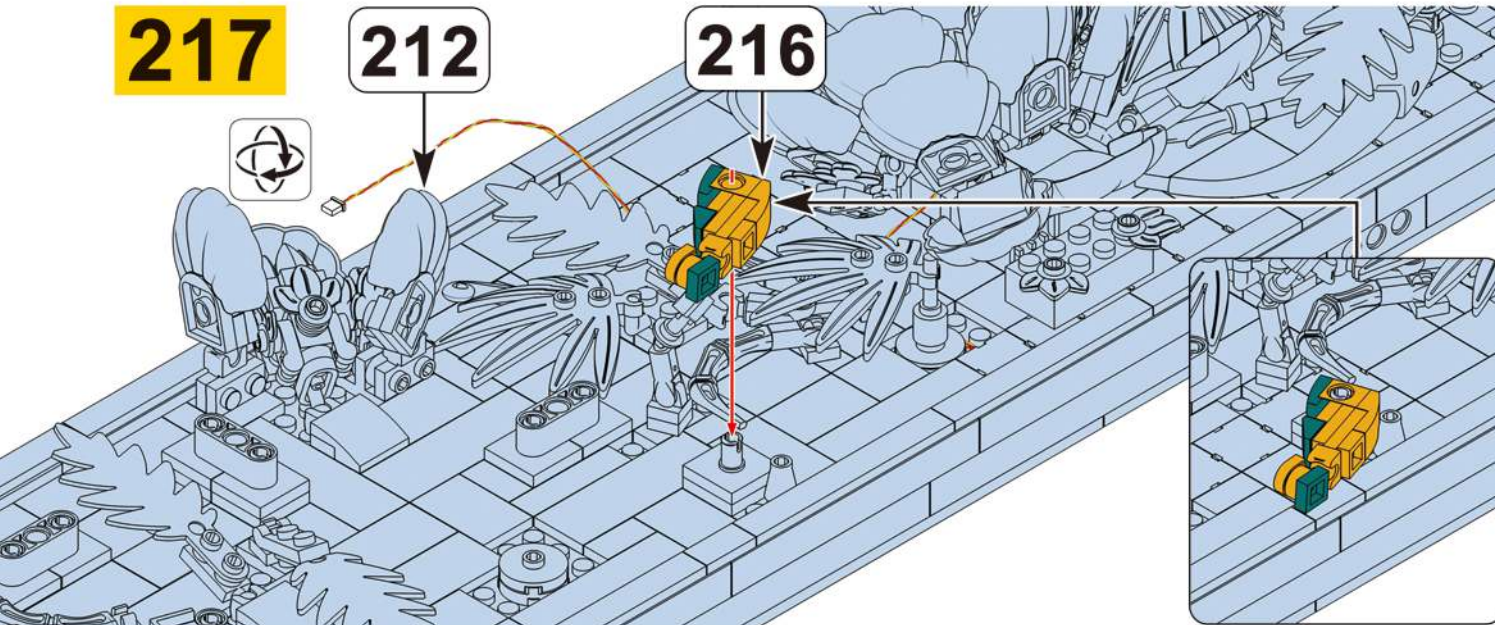

**218**

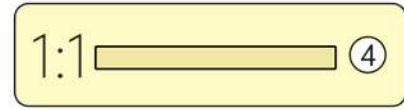
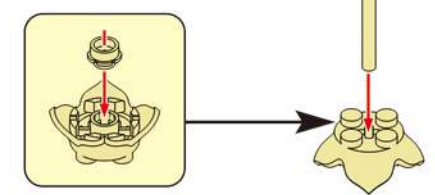

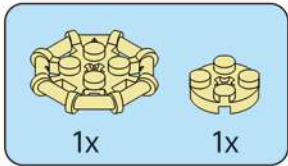

**219**

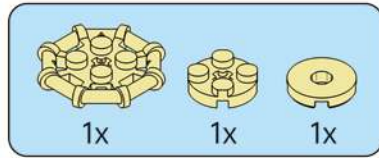
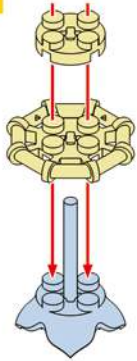

**220**

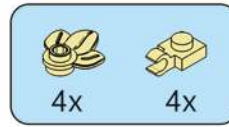
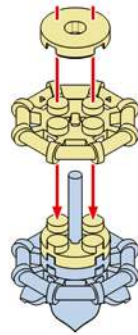

**221**

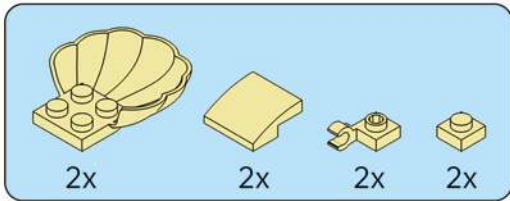
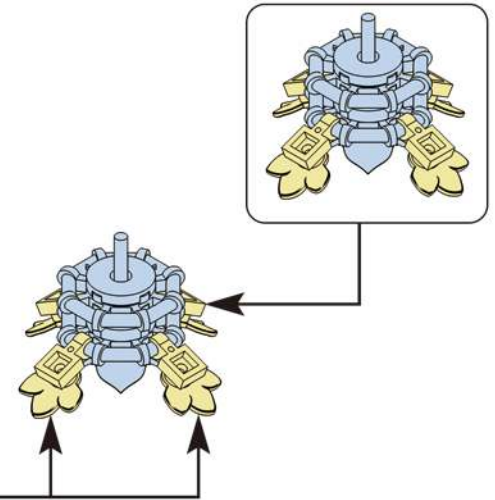
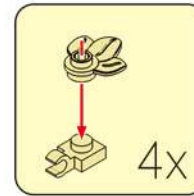

**222**

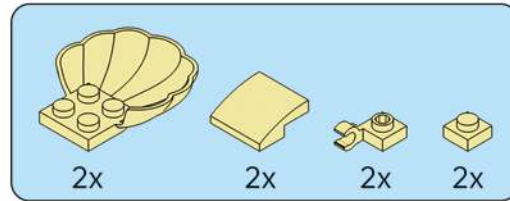
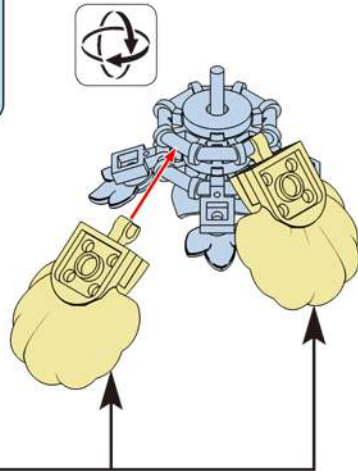
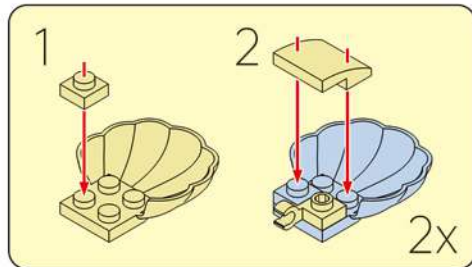

**223**

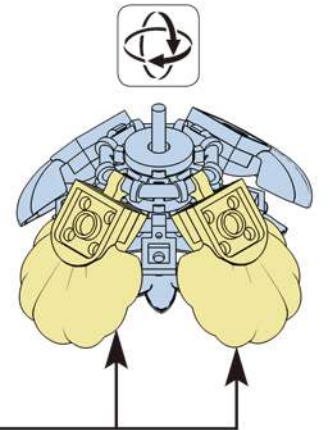
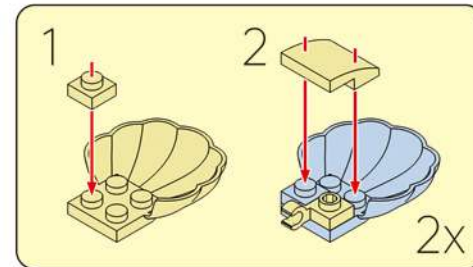

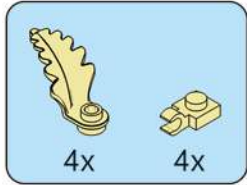

224

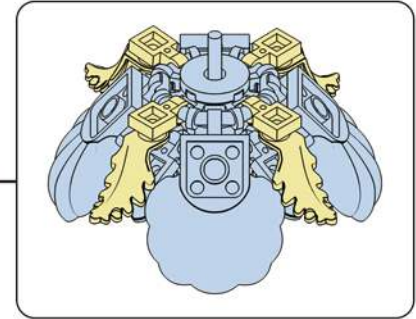
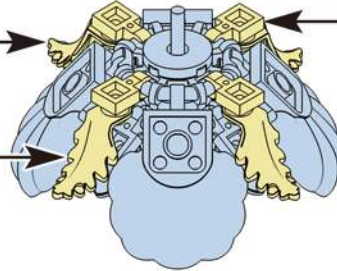
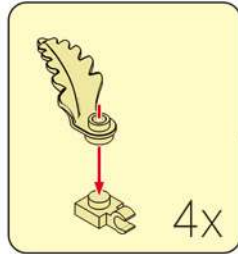

225

224

217

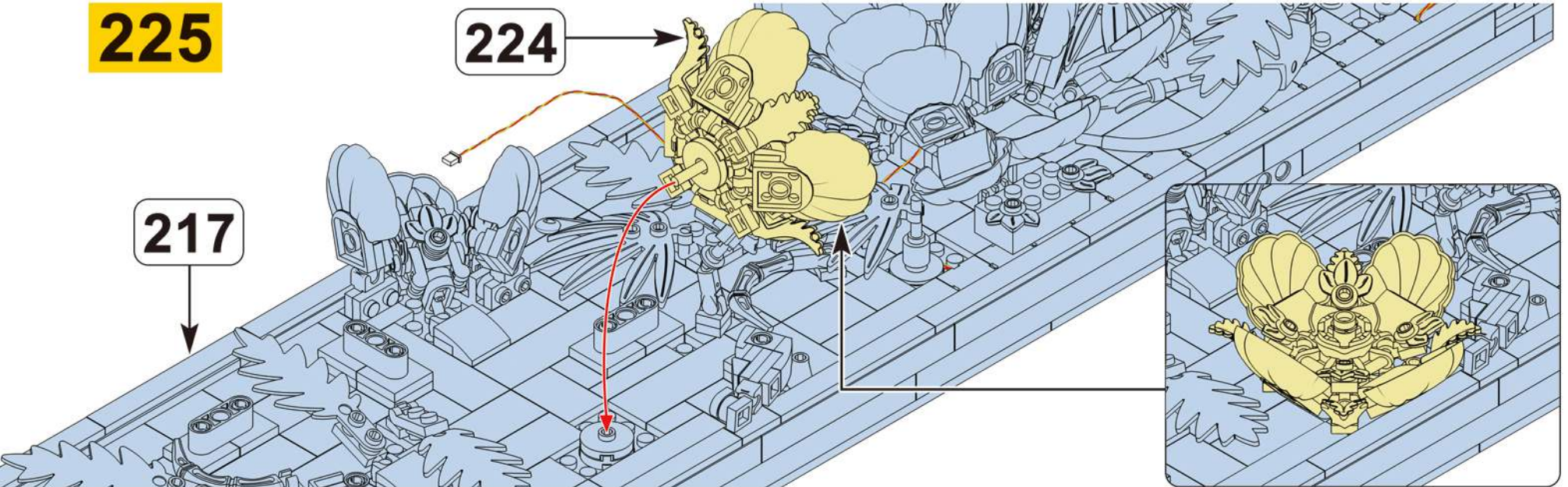

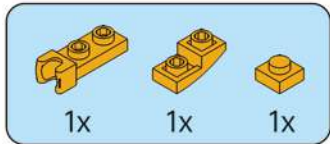

**226**

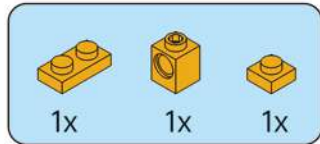
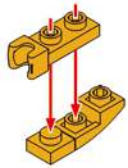

**227**

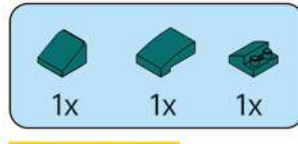
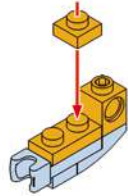

**228**

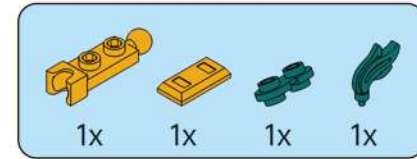
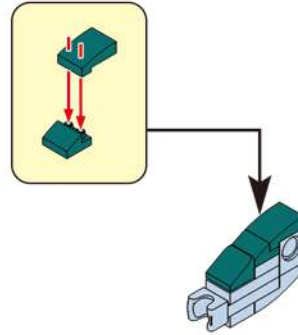

**229**

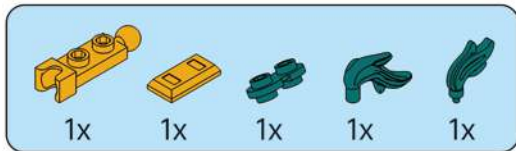
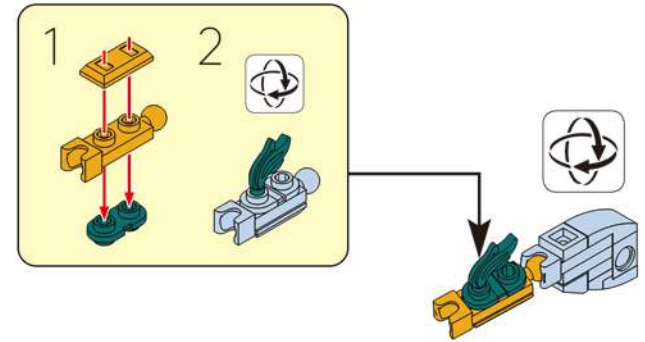

**230**

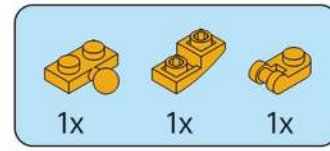
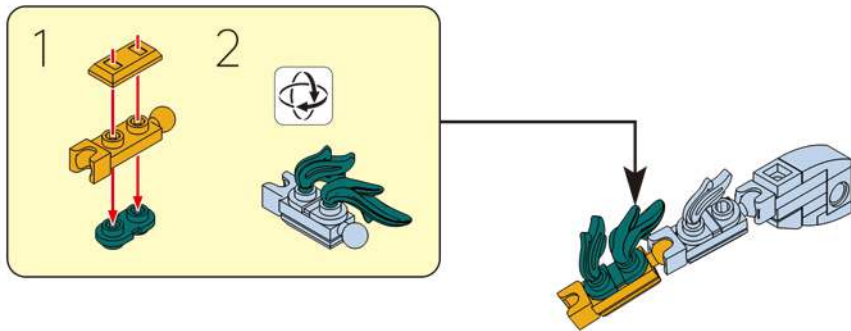

**231**

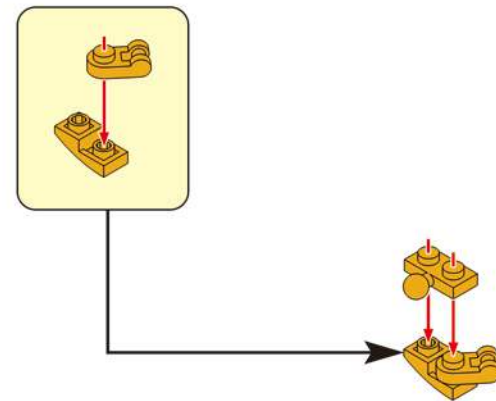

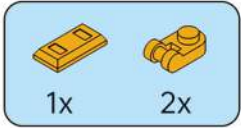

# 232

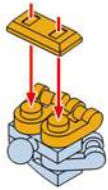

# 233

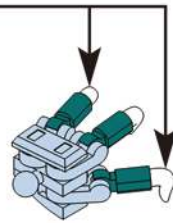
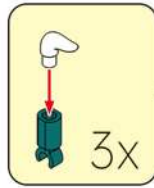

# 234

# 230

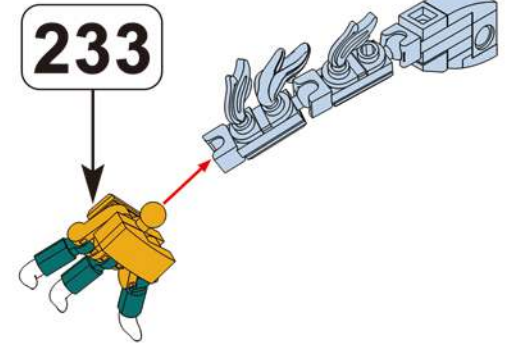

# 235

# 234

# 225

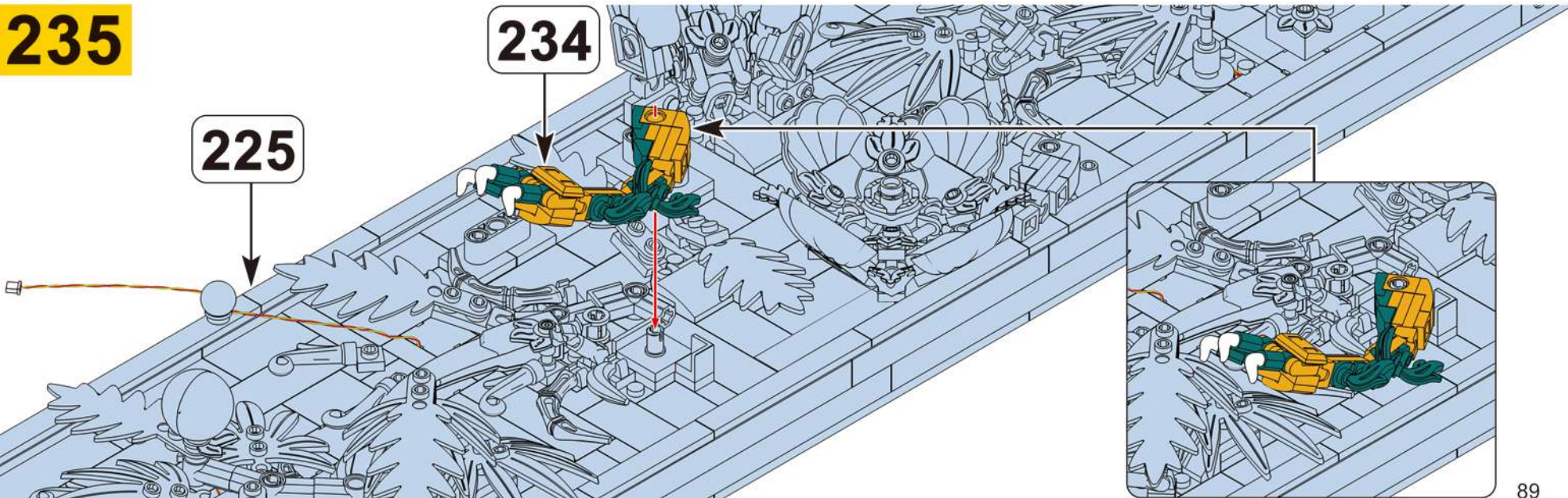

# JOY MAKES BRILLIANCE.

---

## Embrace Relaxation Embrace Joy

---

Every adulescent needs a "JOY BOX".  
Please , open your JOY BOX ! Heading for joy.

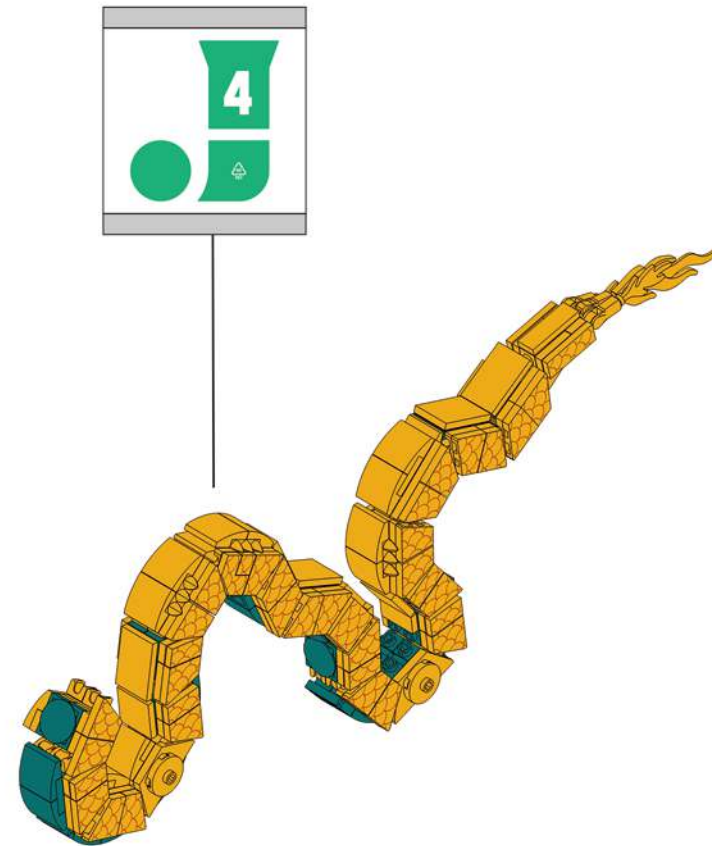

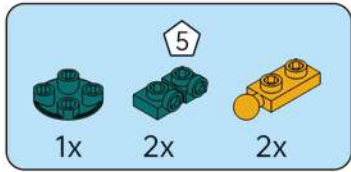

**236**

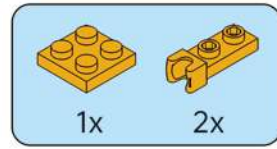
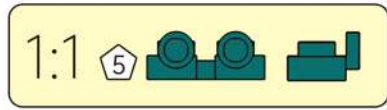
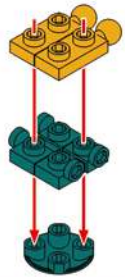

**237**

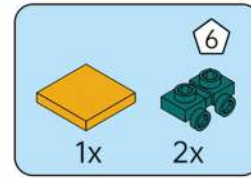
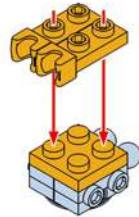

**238**

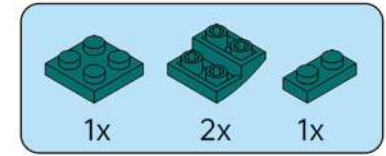
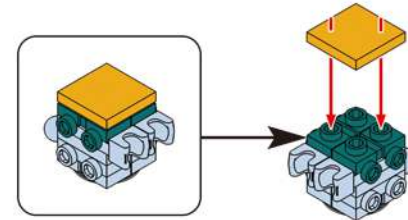
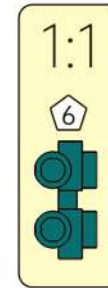

**239**

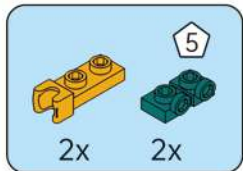
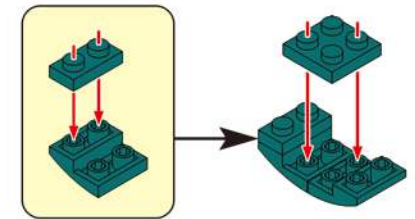

**240**

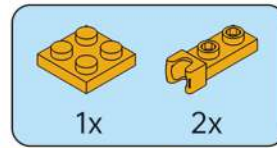
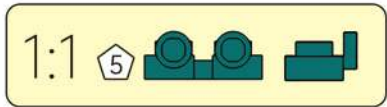
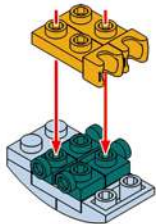

**241**

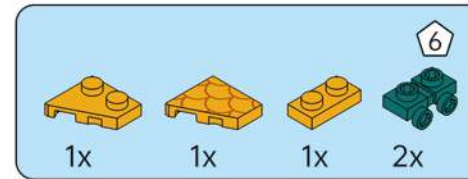
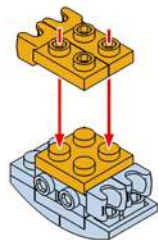

**242**

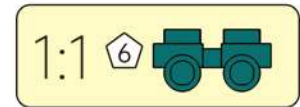
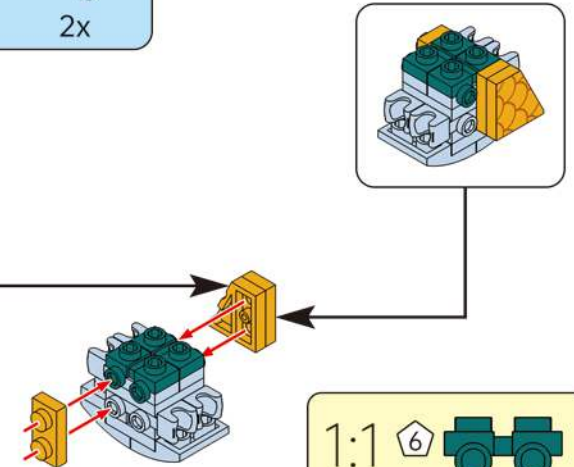
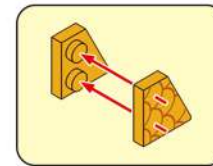

**243**

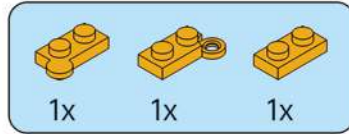
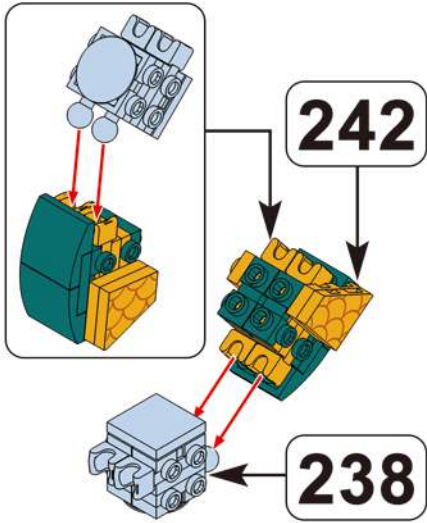

**244**

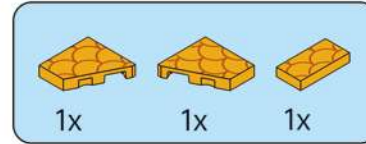
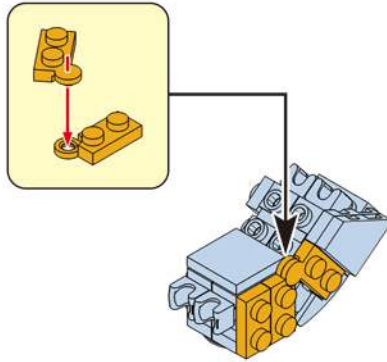

**245**

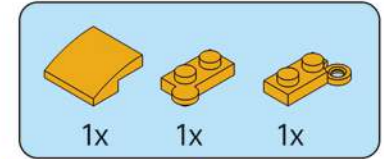
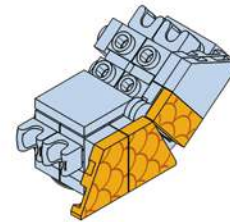

**246**

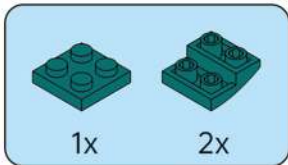
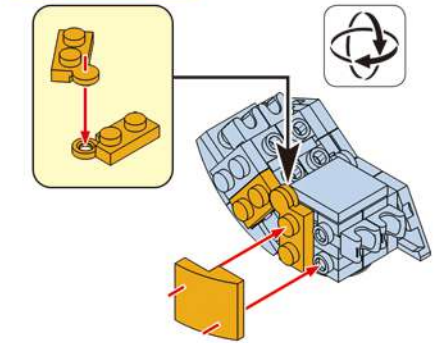

**247**

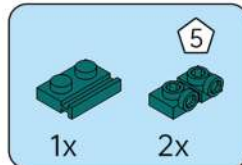
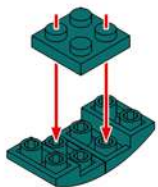

**248**

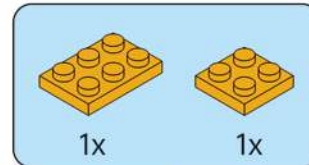
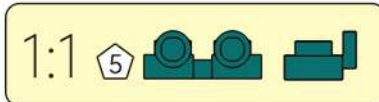
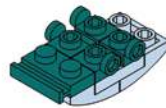

**249**

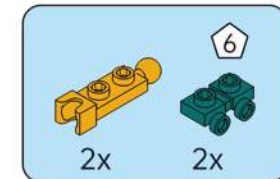
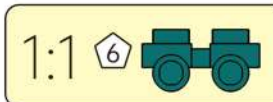
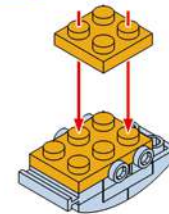

**250**

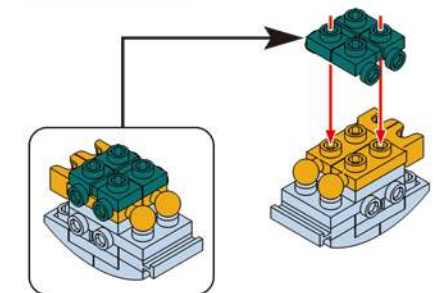

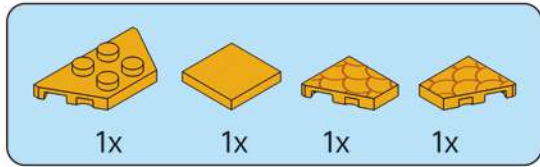

# 251

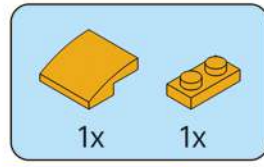
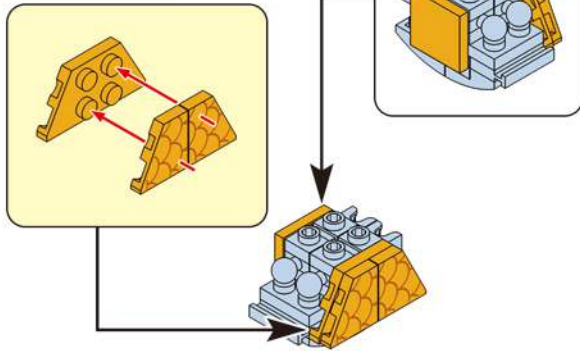

# 252

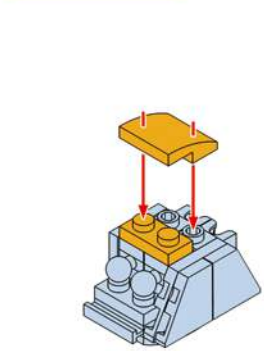

# 253

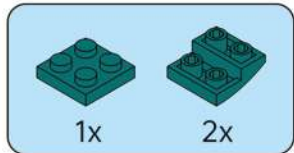
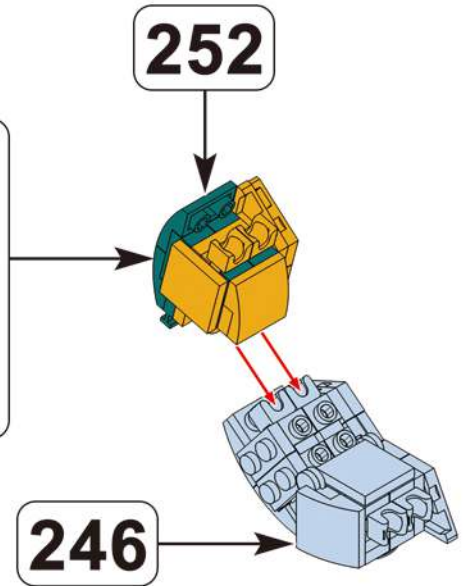
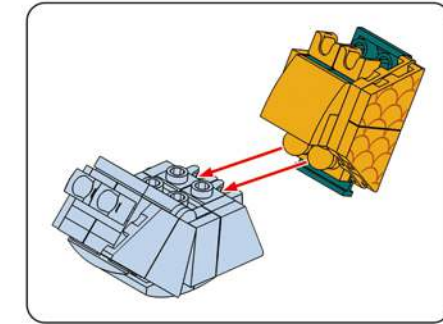

# 254

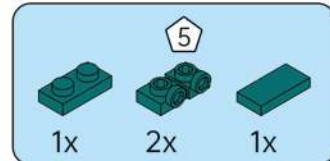
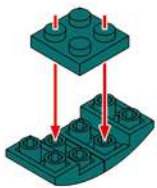

# 255

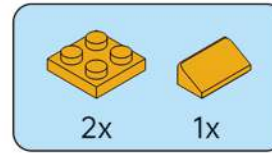
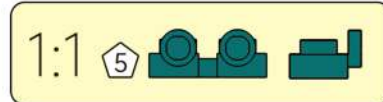

# 256

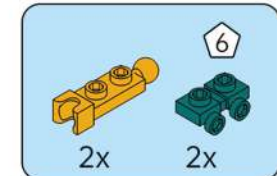
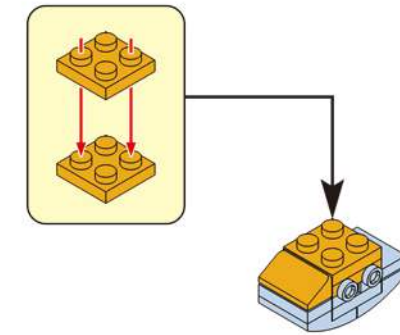

# 257

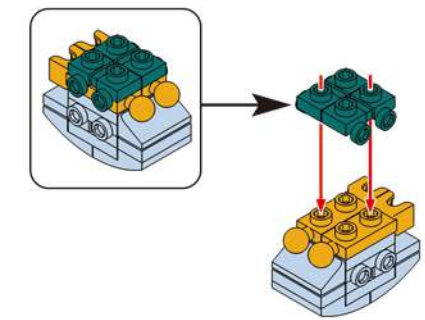

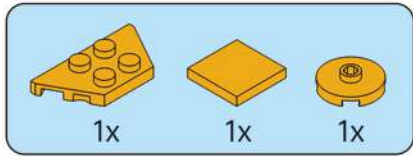

**258**

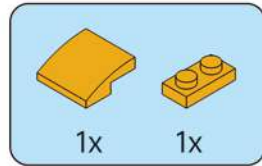
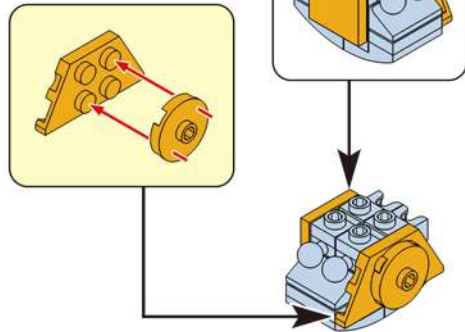

**259**

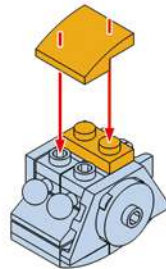

**260**

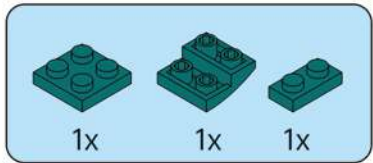
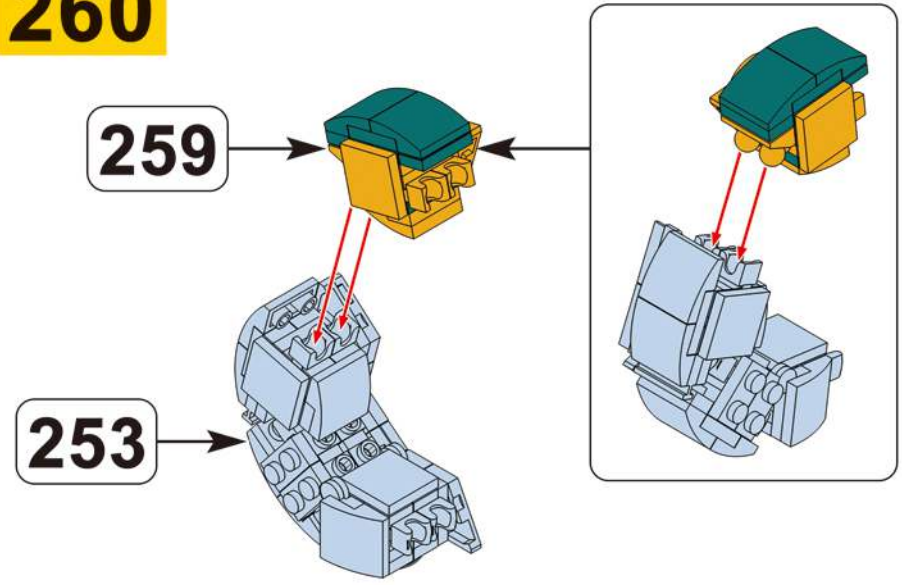

**261**

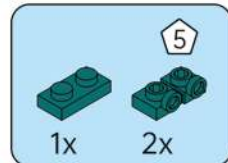
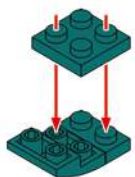

**262**

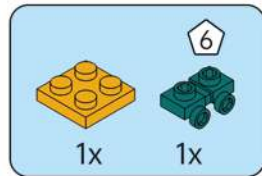

**263**

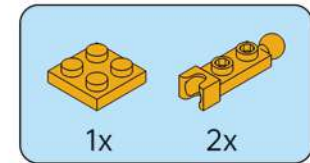
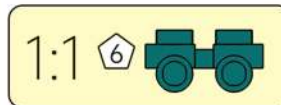
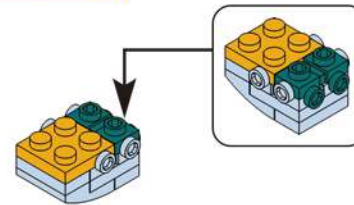

**264**

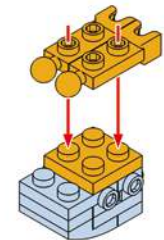

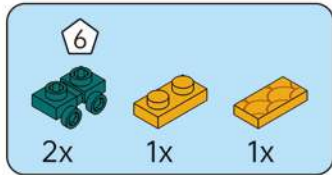

**265**

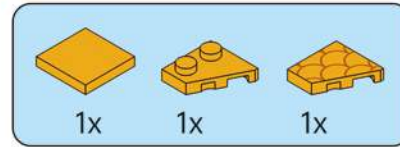
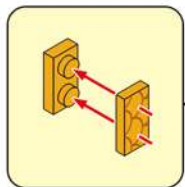
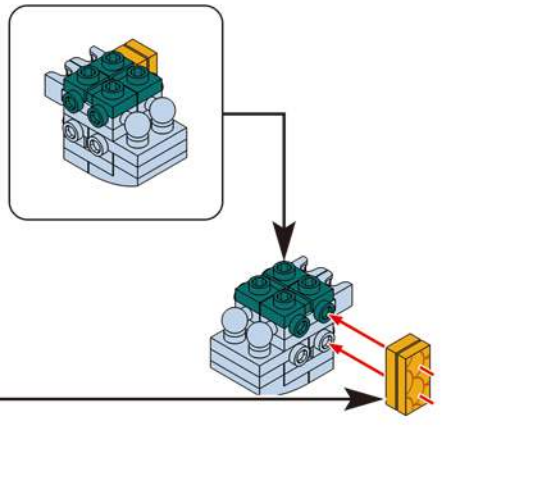
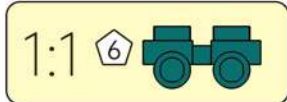

**266**

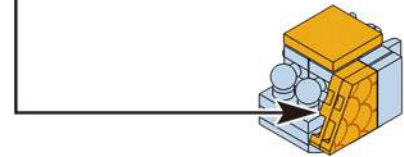
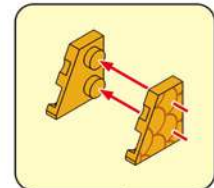

**267**

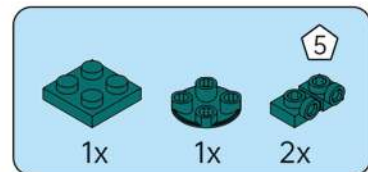
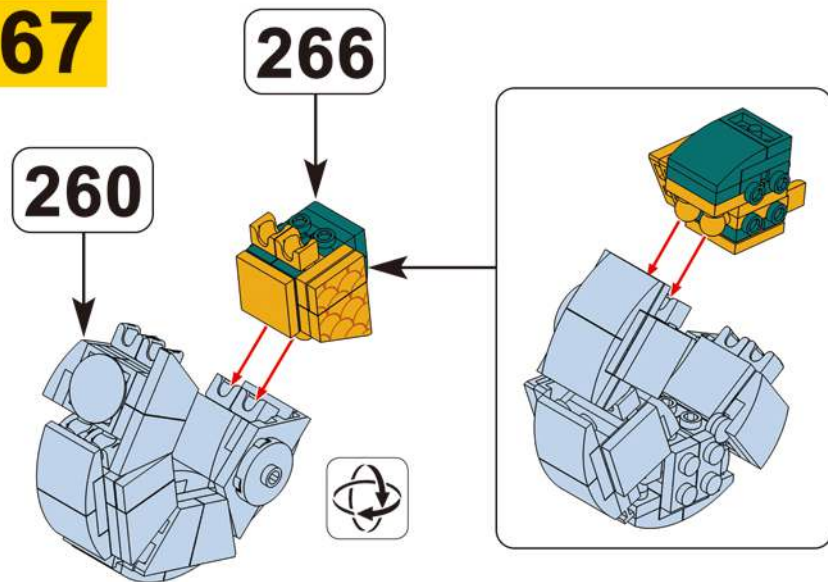

**268**

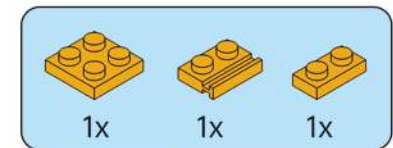
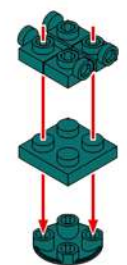

**269**

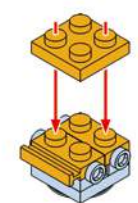

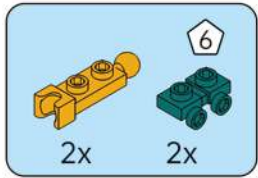

**270**

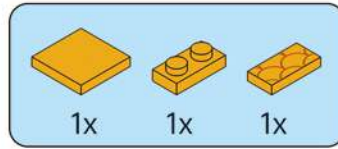
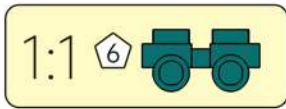
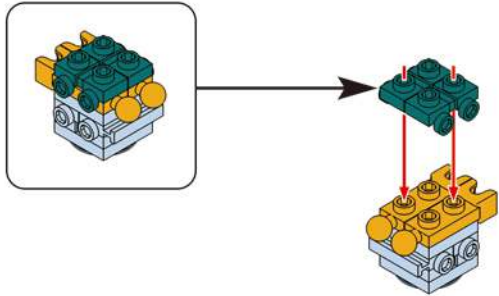

**271**

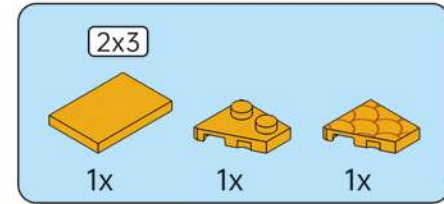
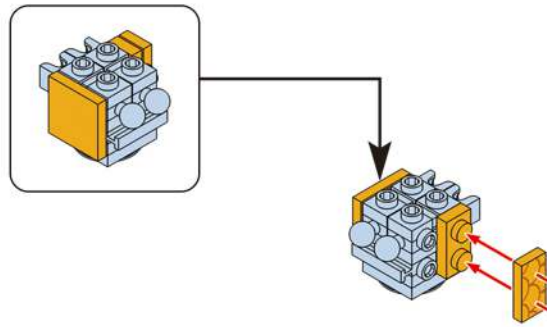

**272**

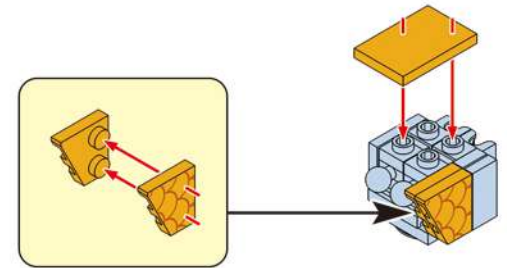

**273**

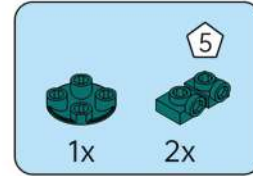
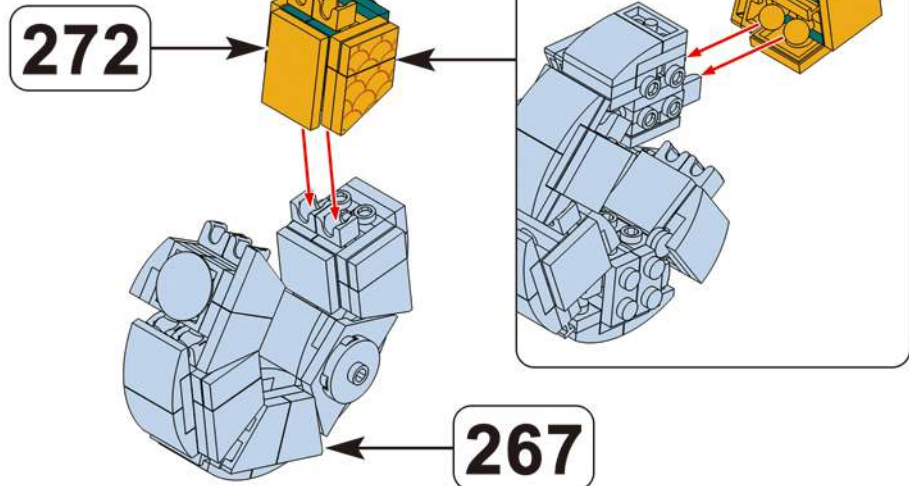

**274**

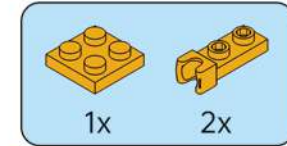
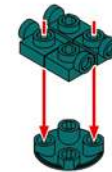

**275**

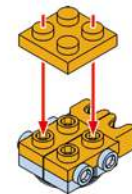

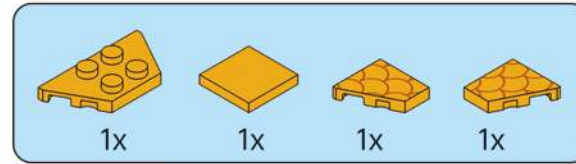
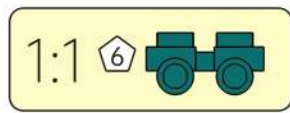
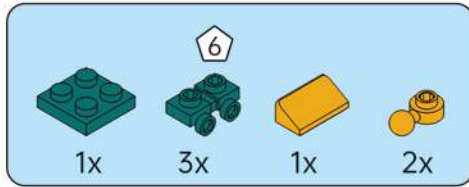

**276**

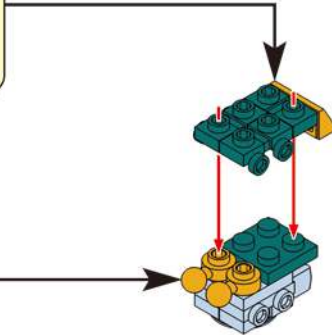
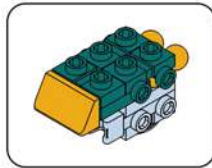
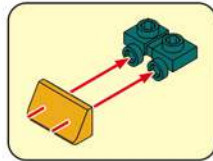

**277**

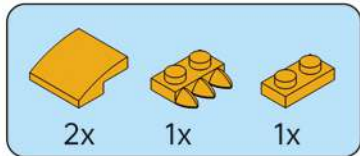
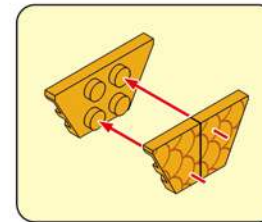
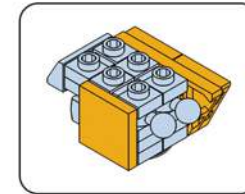

**278**

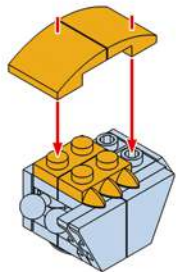

**279**

**278**

**273**

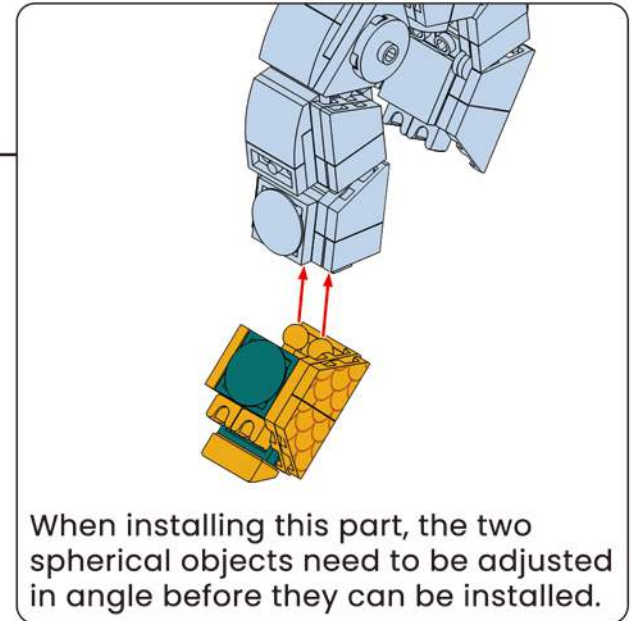
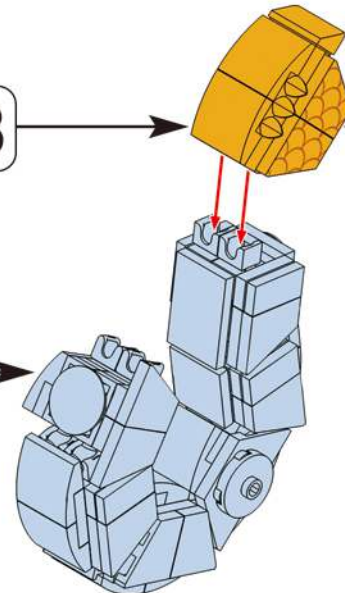

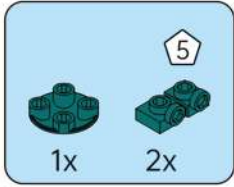

**280**

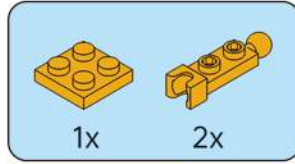
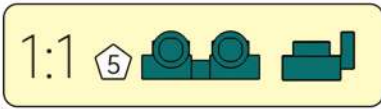
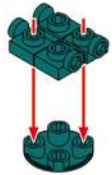

**281**

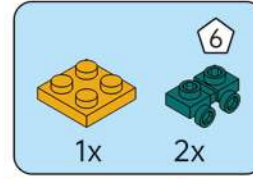
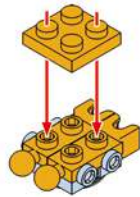

**282**

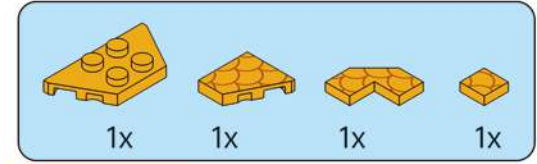
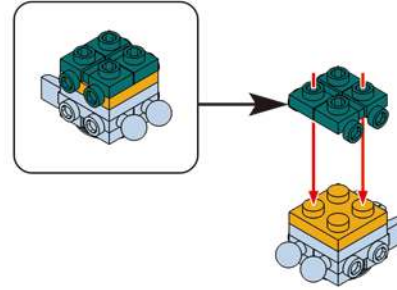

**283**

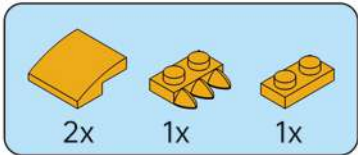
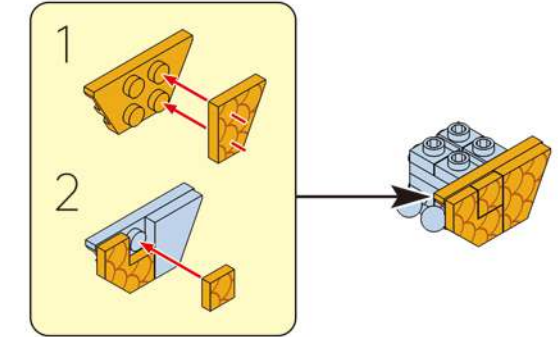

**284**

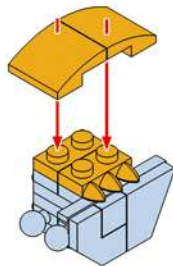

**285**

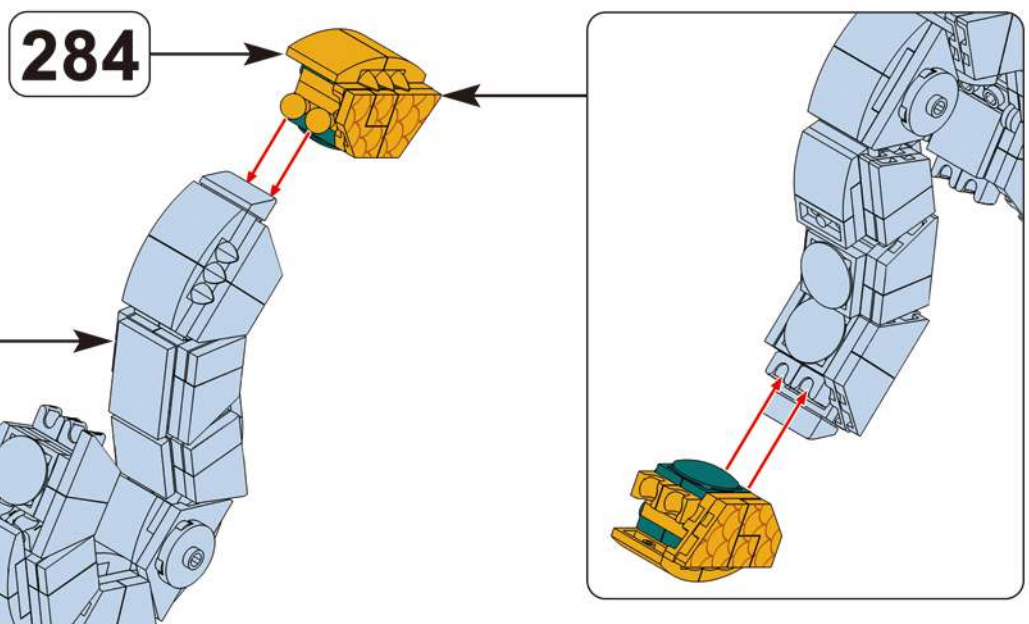

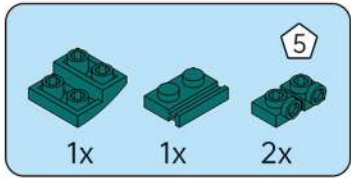

**286**

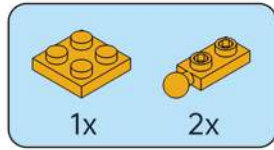
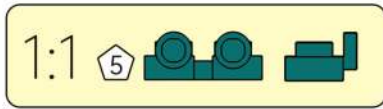
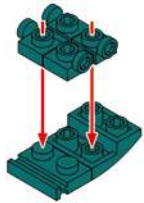

**287**

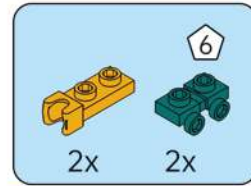
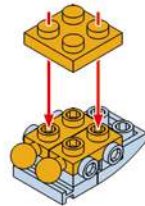

**288**

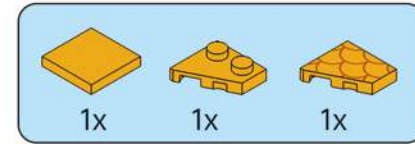
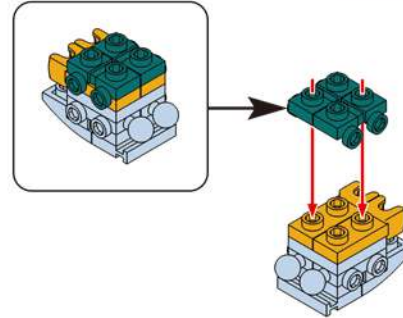

**289**

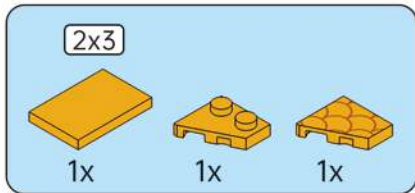
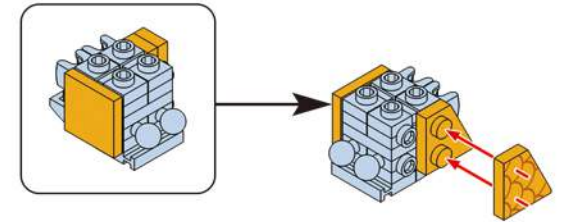

**290**

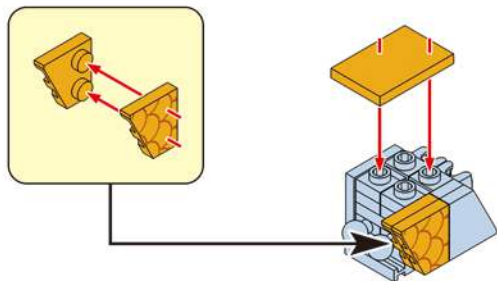

**291**

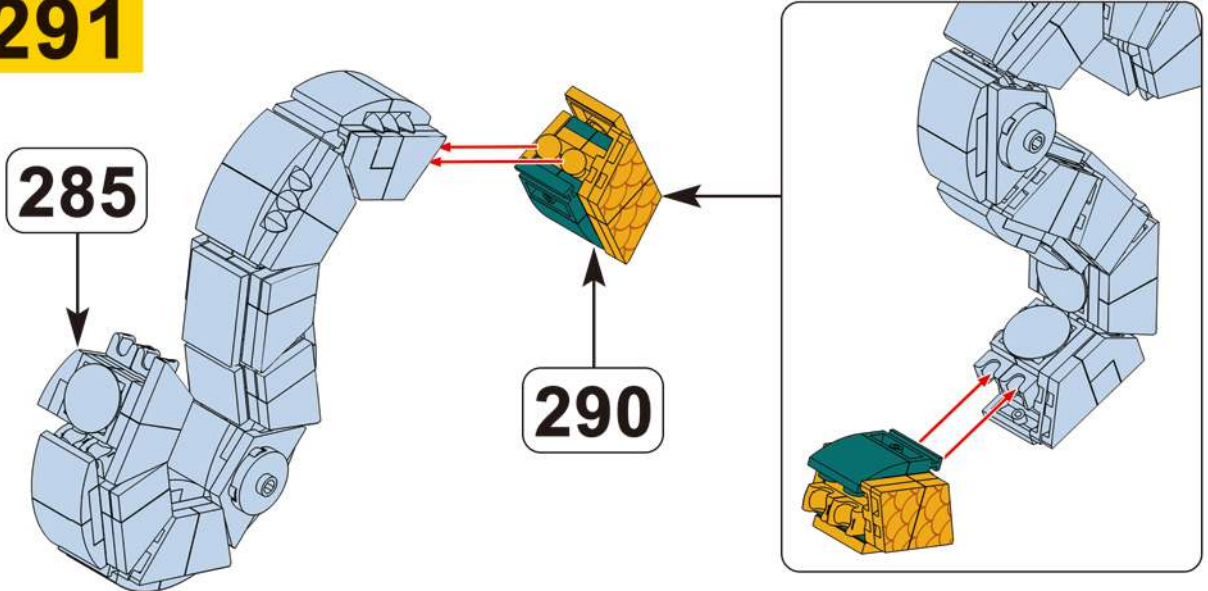

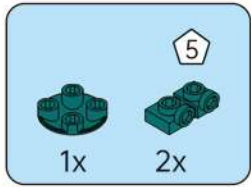

**292**

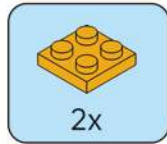
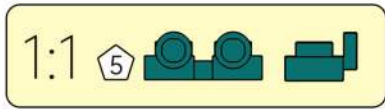
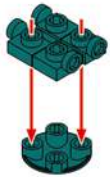

**293**

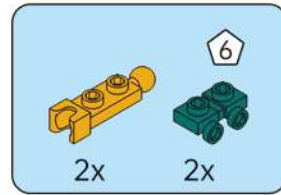
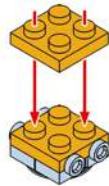

**294**

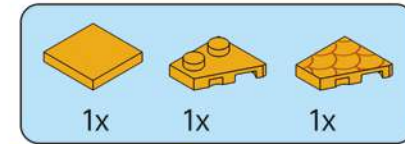
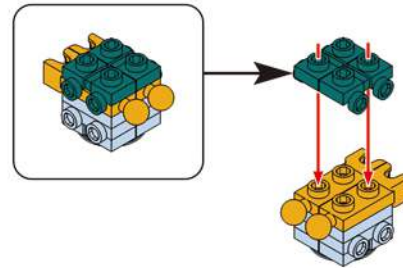

**295**

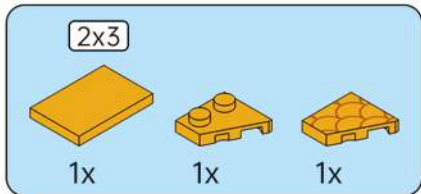
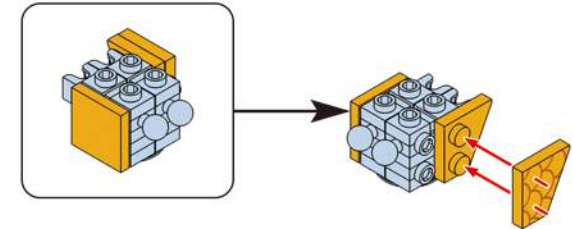

**296**

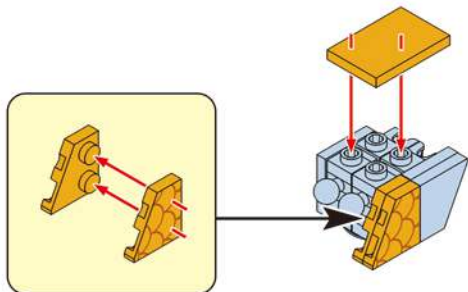

**297**

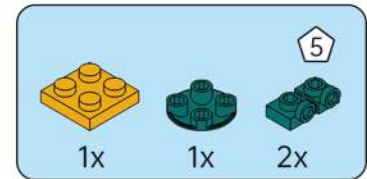
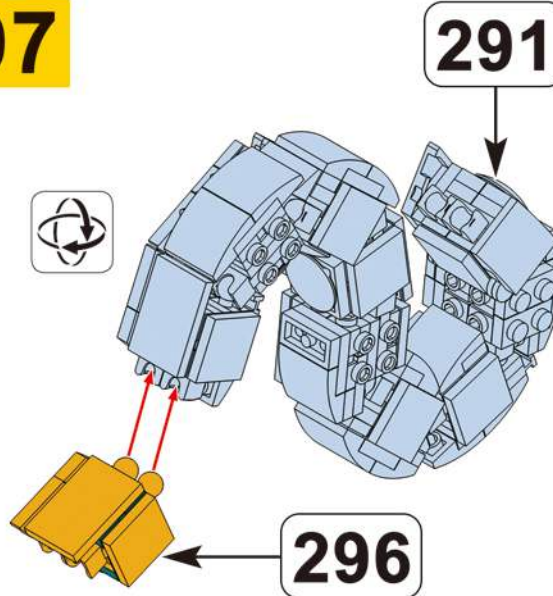

**298**

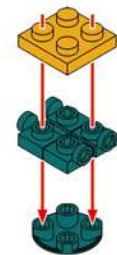

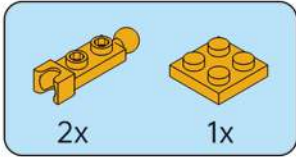

**299**

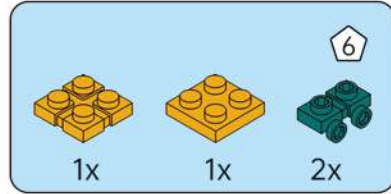
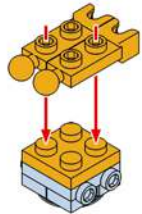

**300**

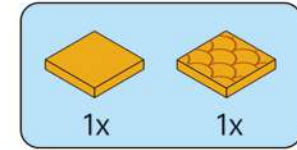
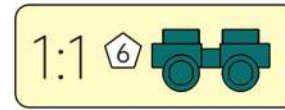
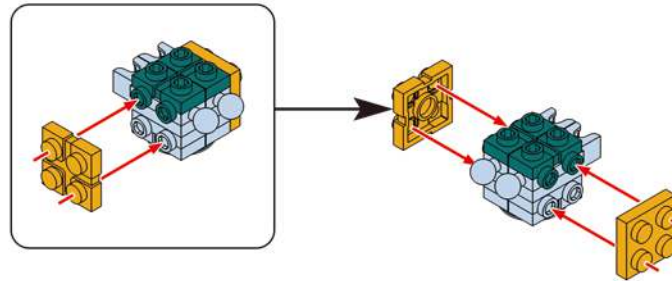

**301**

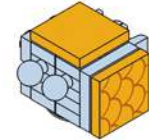

**302**

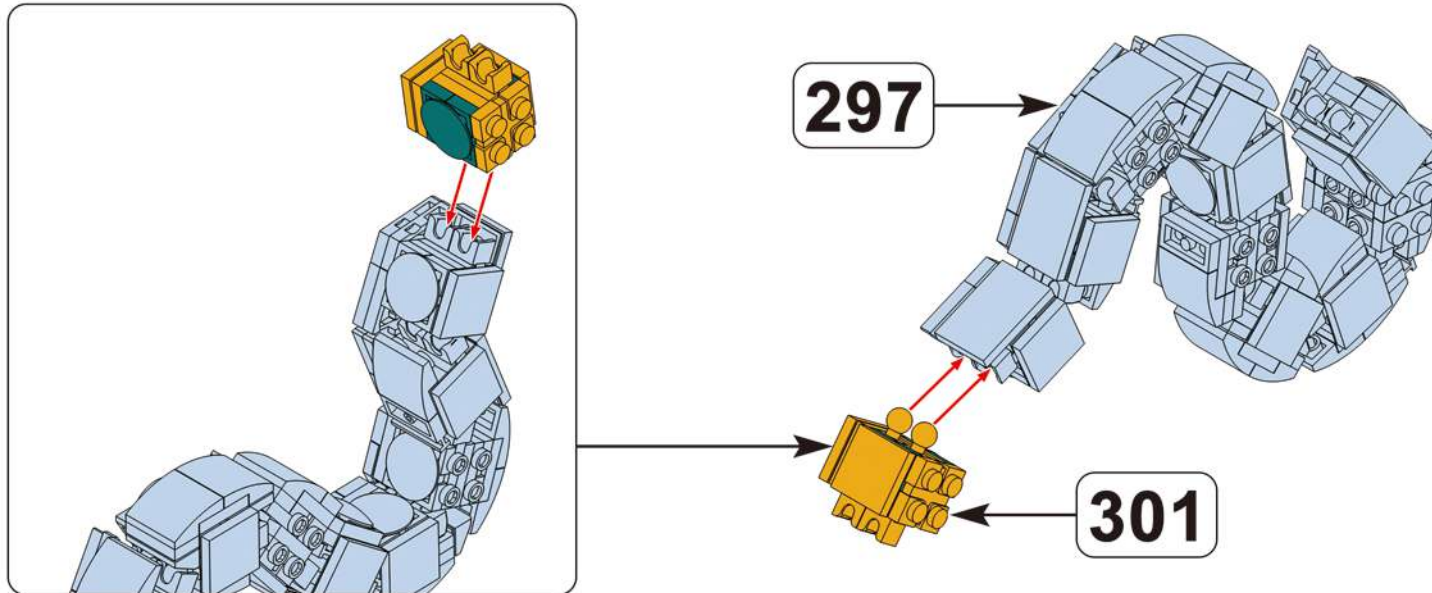

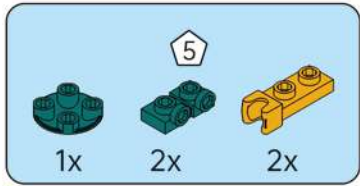

**303**

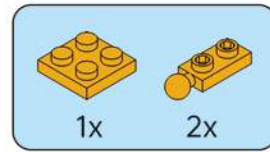
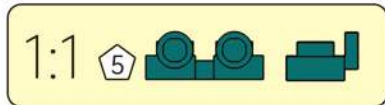
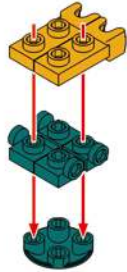

**304**

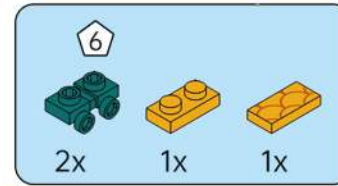
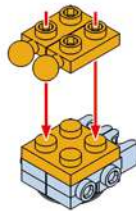

**305**

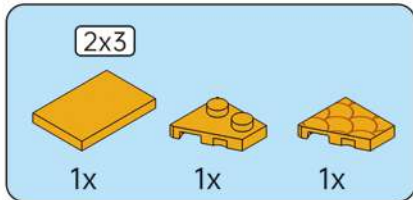
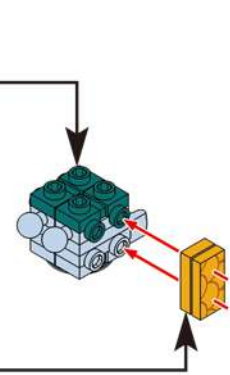
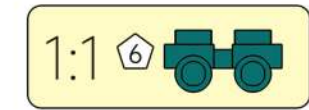
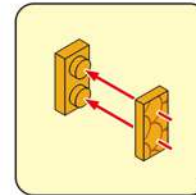
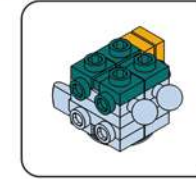

**306**

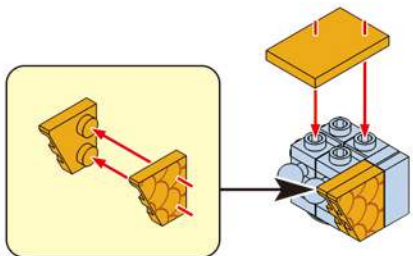

**307**

**302**

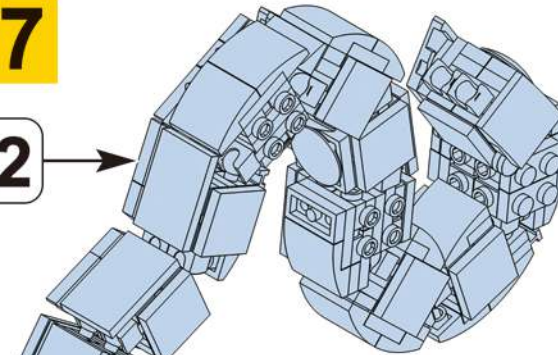

**306**

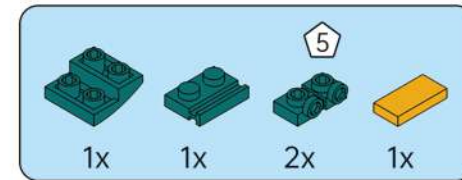

**308**

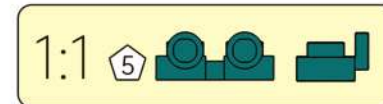
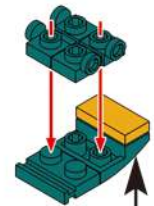
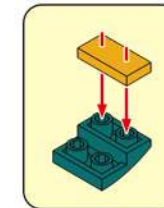

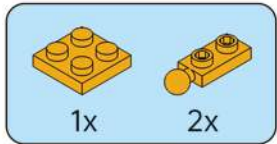

**309**

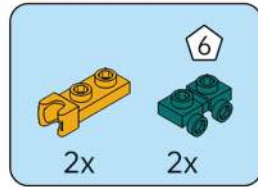
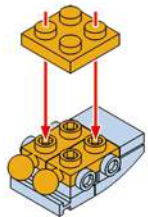

**310**

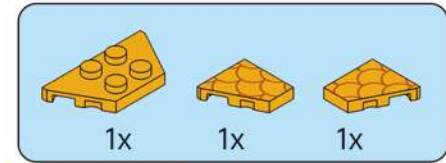
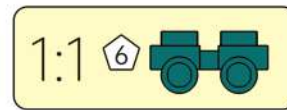
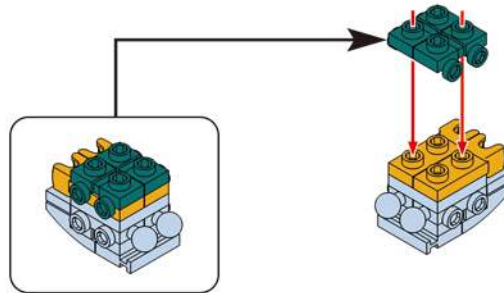

**311**

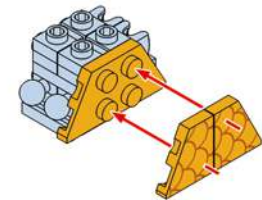

**312**

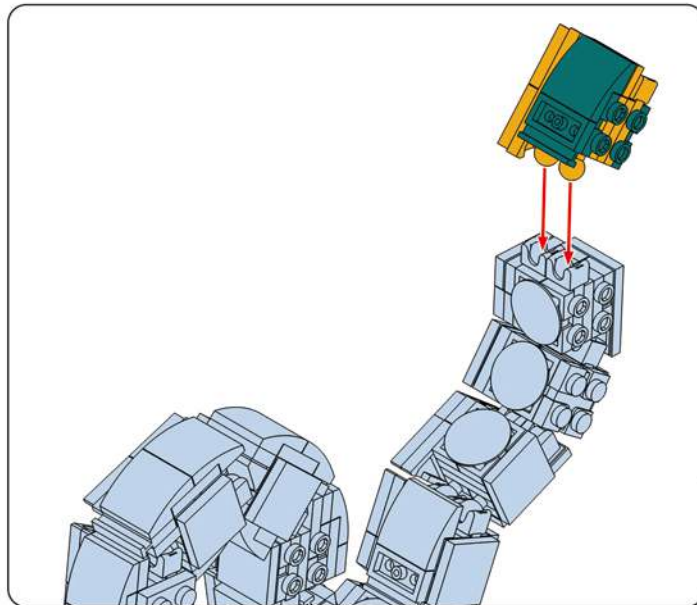

**307**

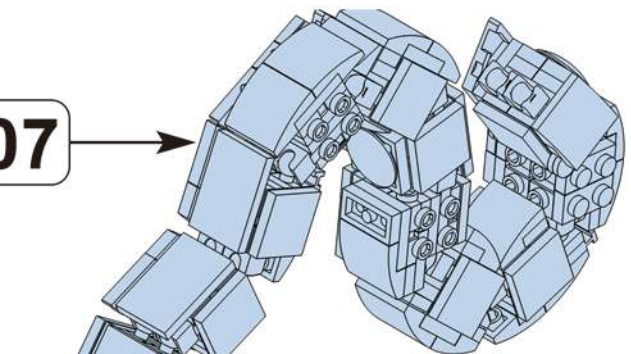

**311**



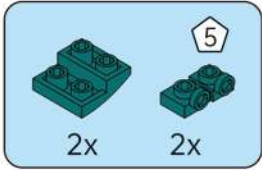

**313**

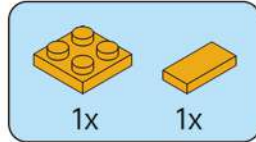
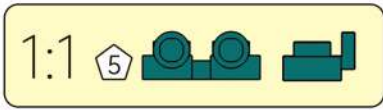
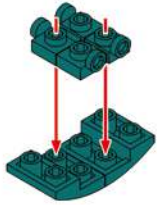

**314**

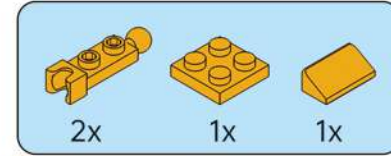

**315**

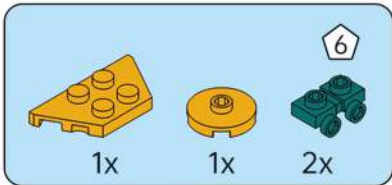
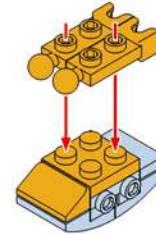

**316**

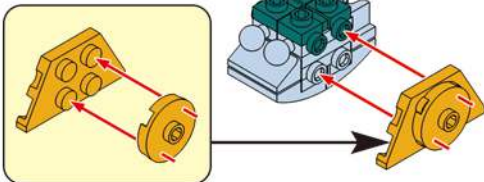
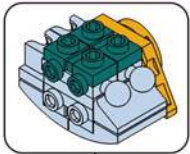

**317**

312

316

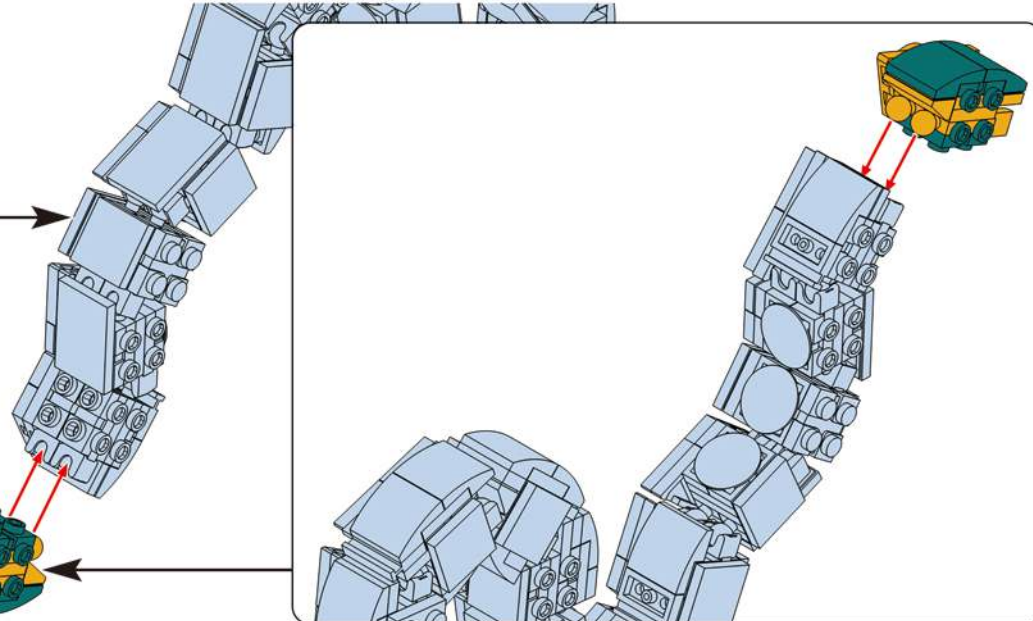

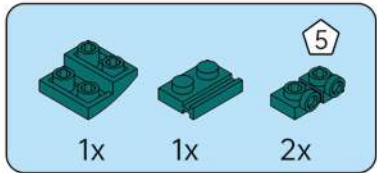

**318**

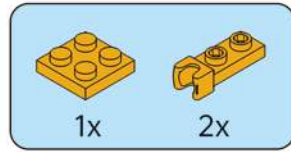
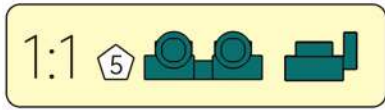
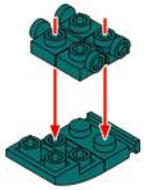

**319**

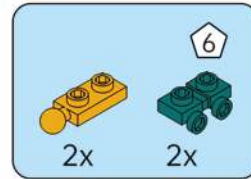
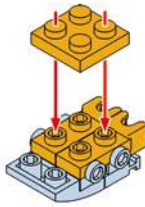

**320**

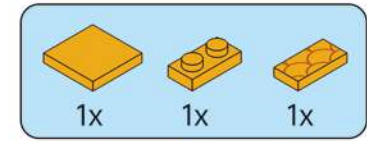
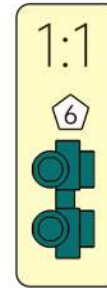
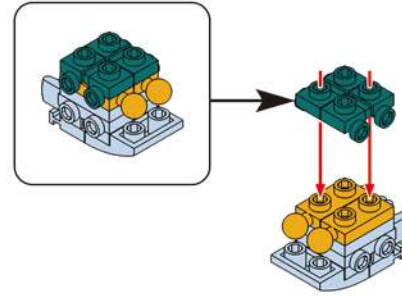

**321**

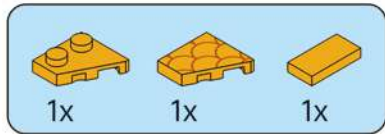
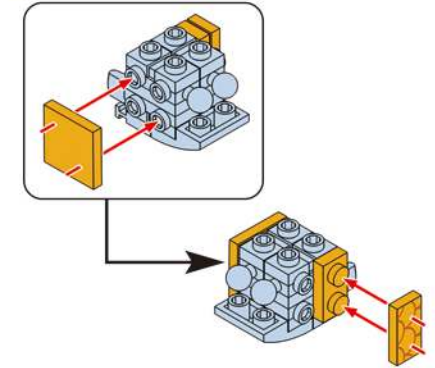

**322**

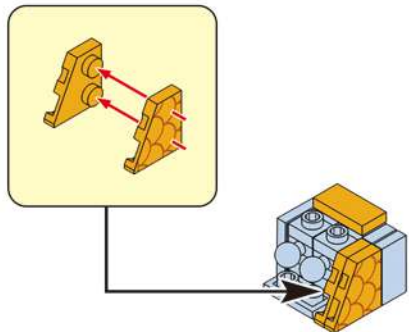

**323**

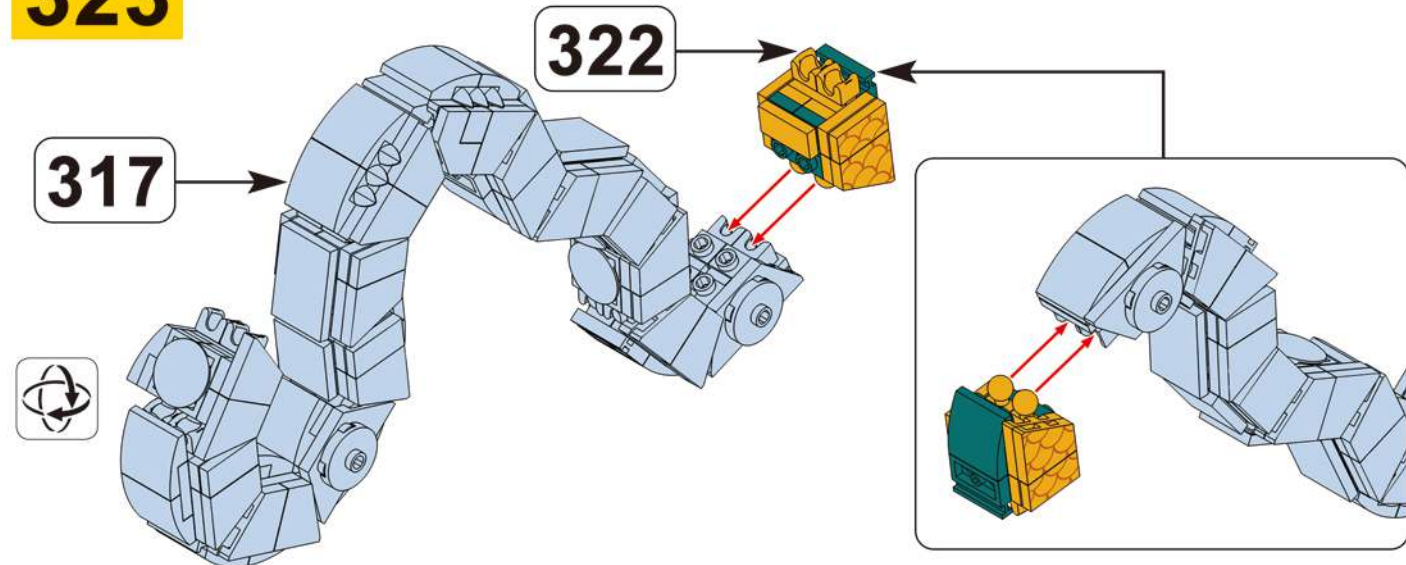

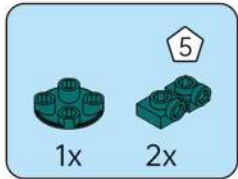

**324**

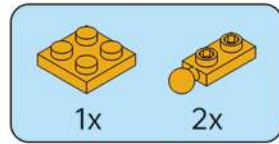
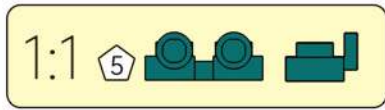
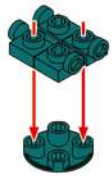

**325**

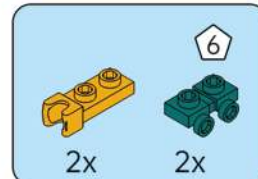
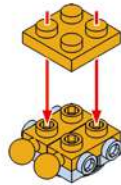

**326**

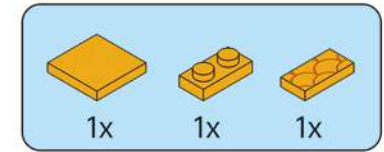
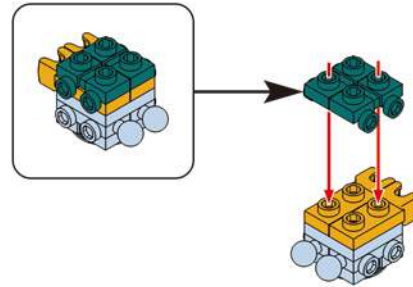

**327**

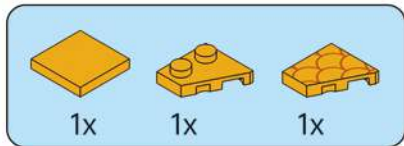
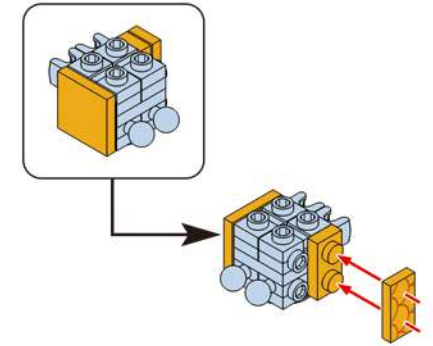

**328**

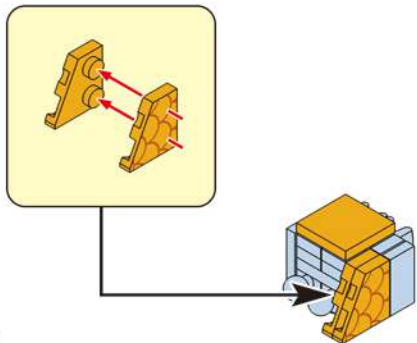

**329**

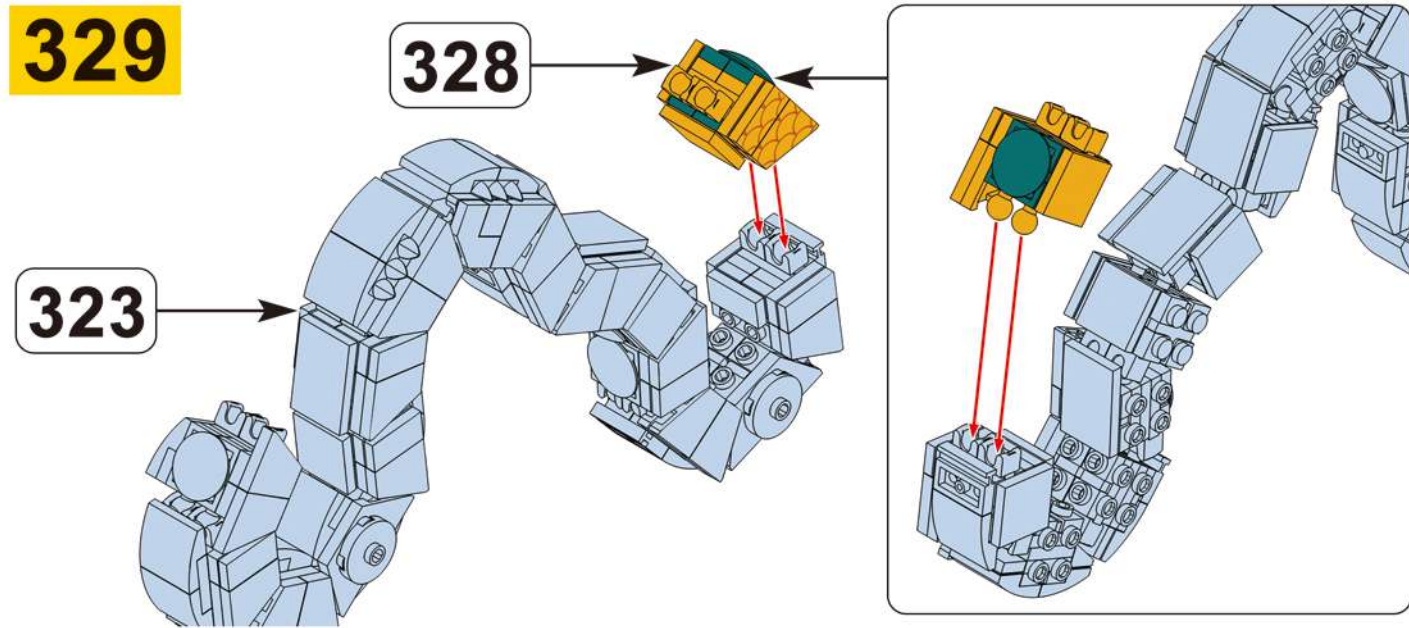

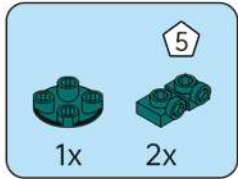

**330**

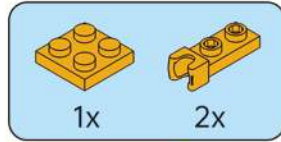
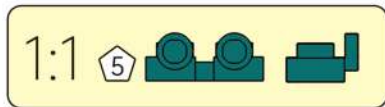
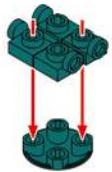

**331**

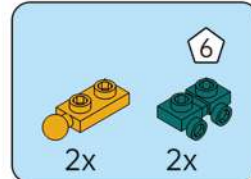
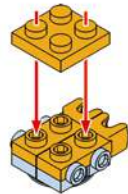

**332**

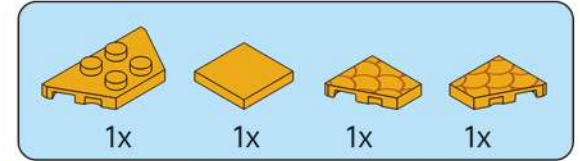
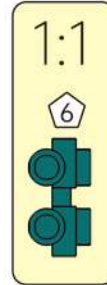
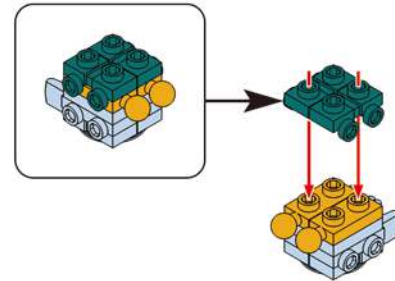

**333**

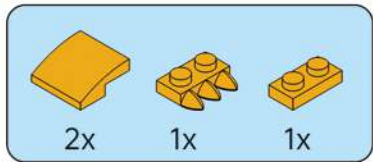
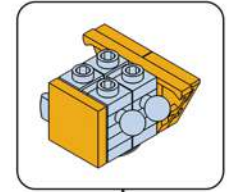
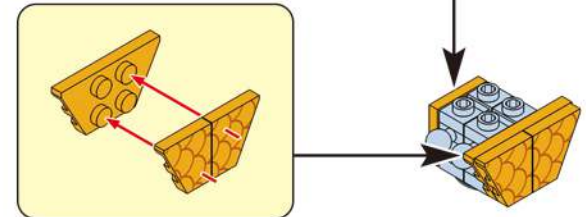

**334**

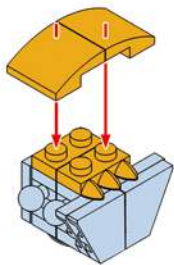

**335**

**334**

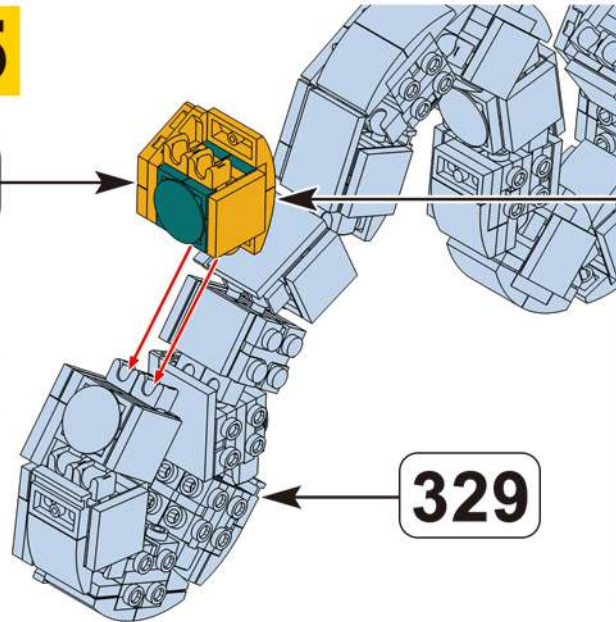

**329**

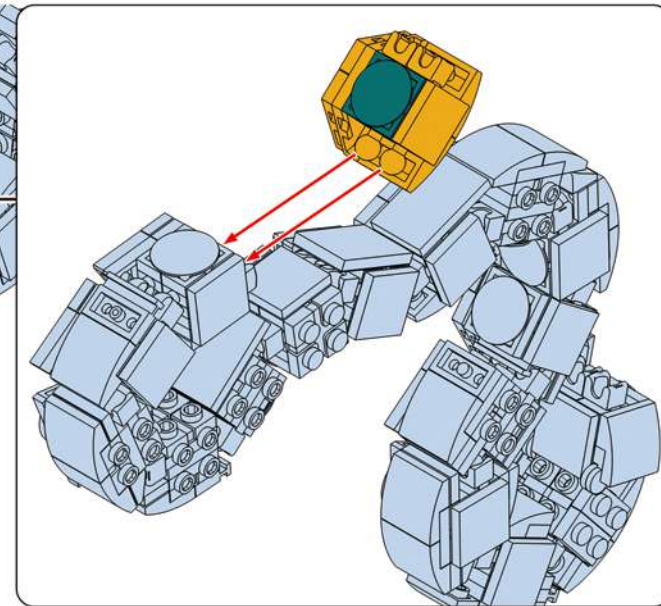

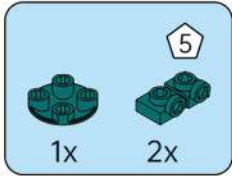

**336**

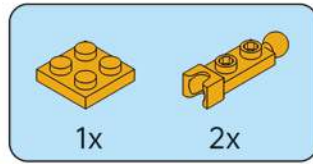
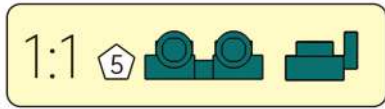
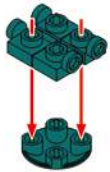

**337**

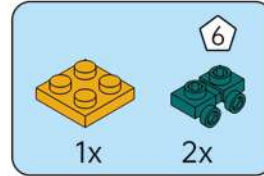
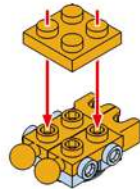

**338**

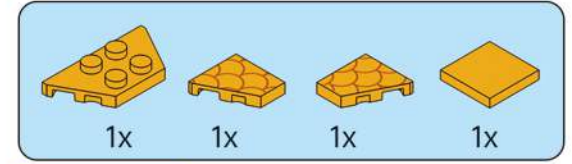
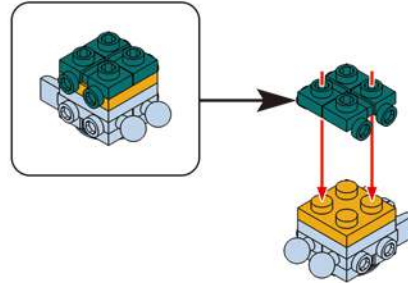

**339**

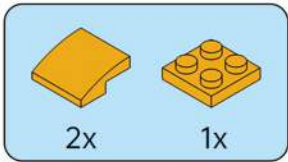
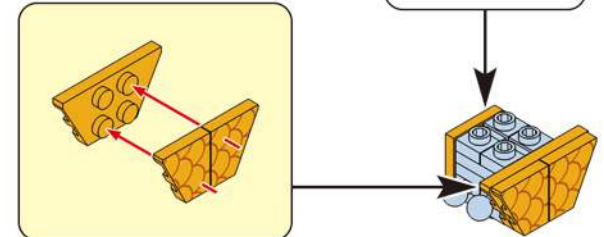

**340**

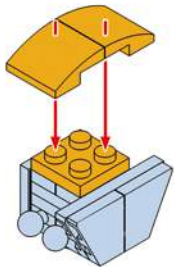

**341**

**340**

**335**

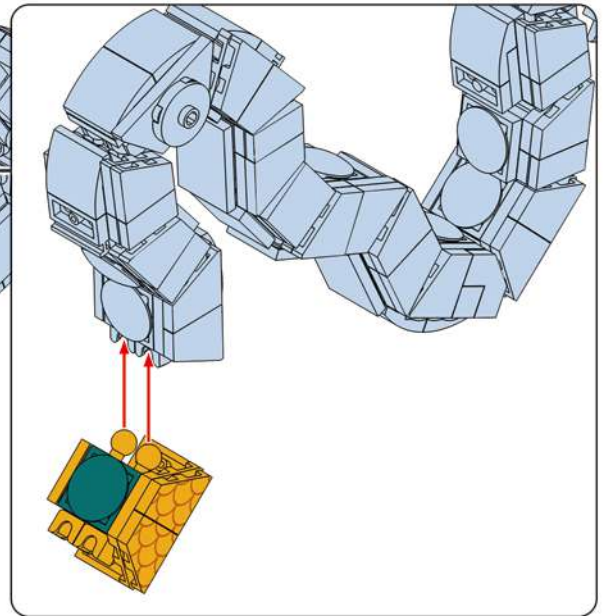
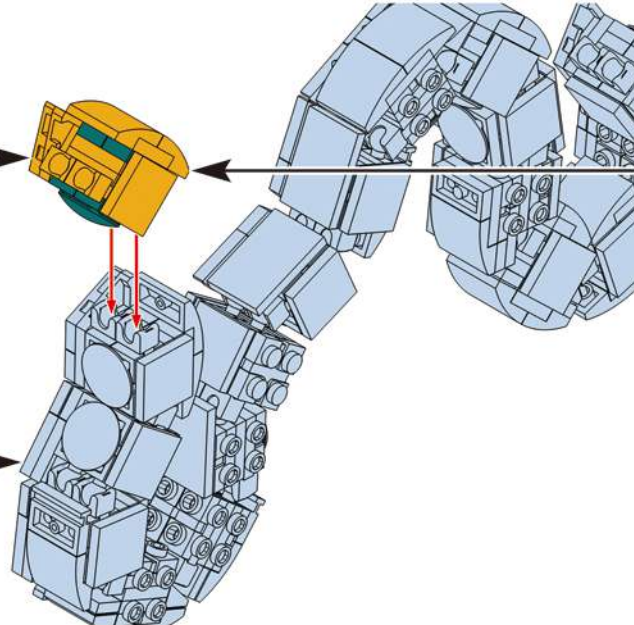

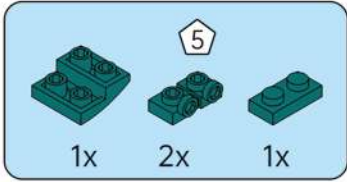

**342**

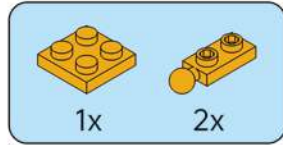
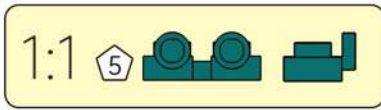
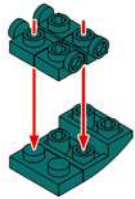

**343**

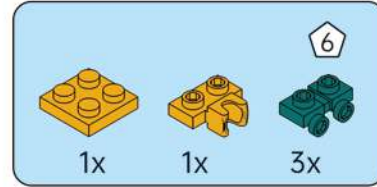
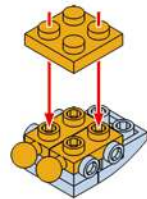

**344**

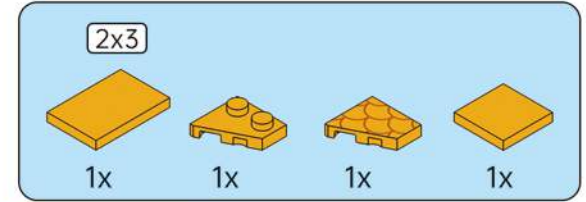
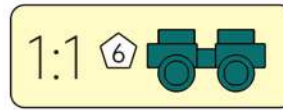
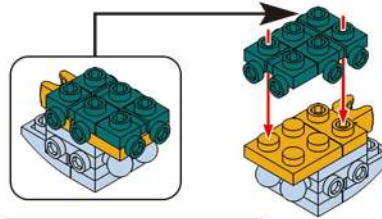

**345**

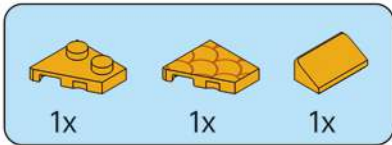
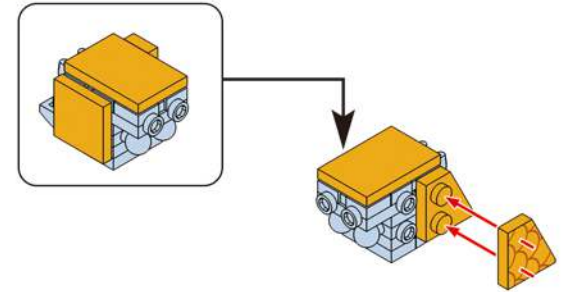

**346**

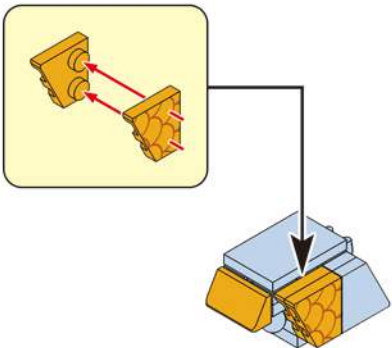

**347**

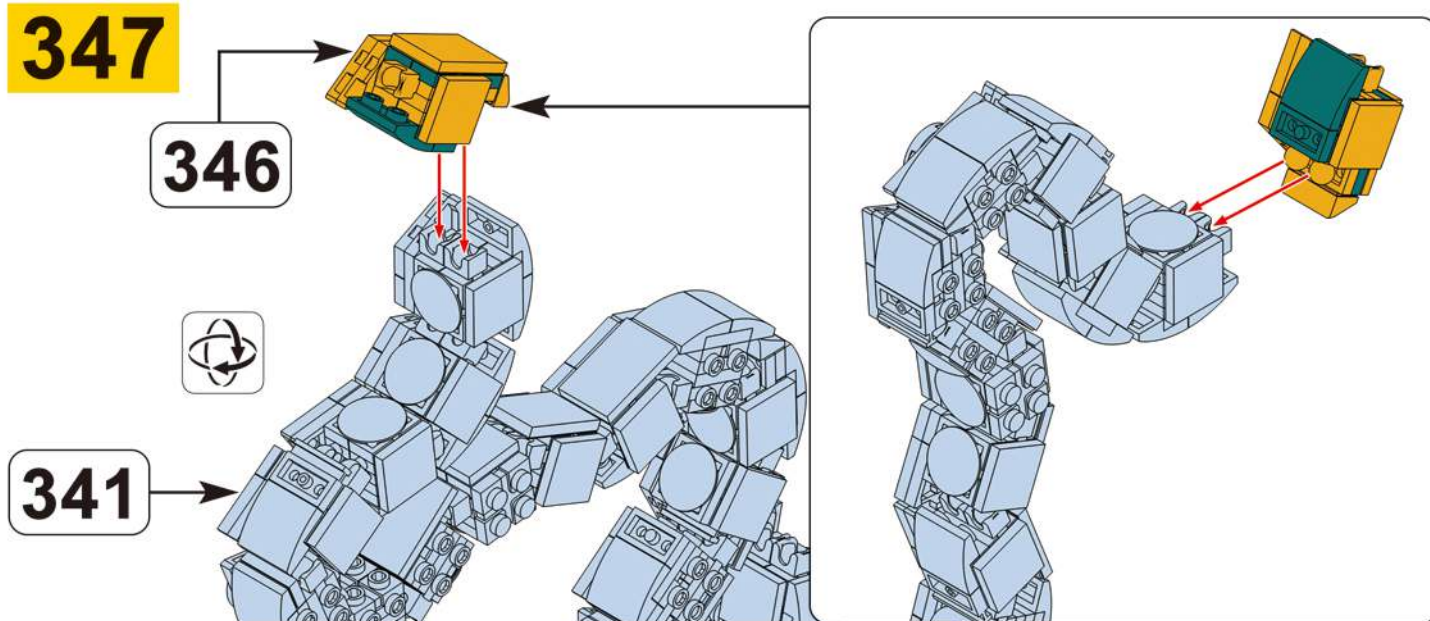

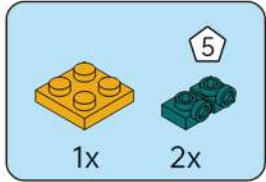

**348**

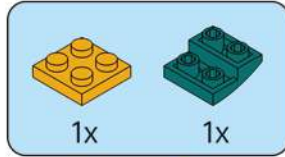
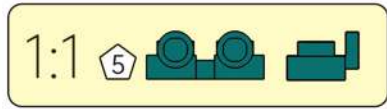
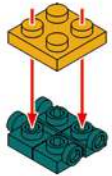

**349**

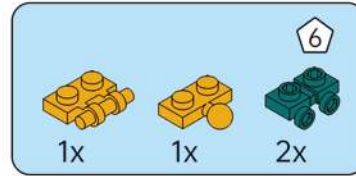
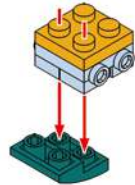

**350**

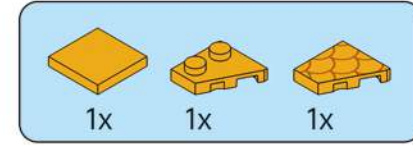
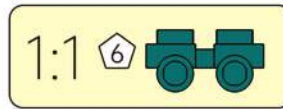
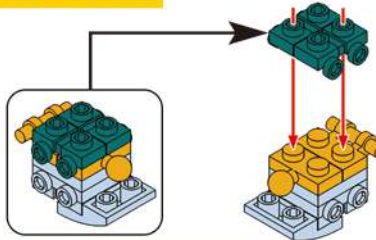

**351**

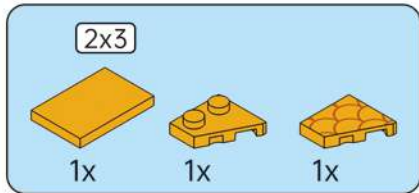
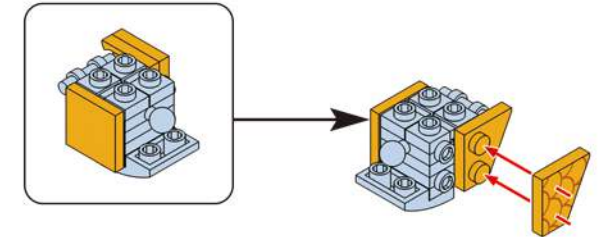

**352**

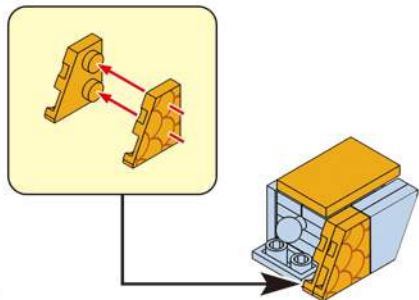

**353**

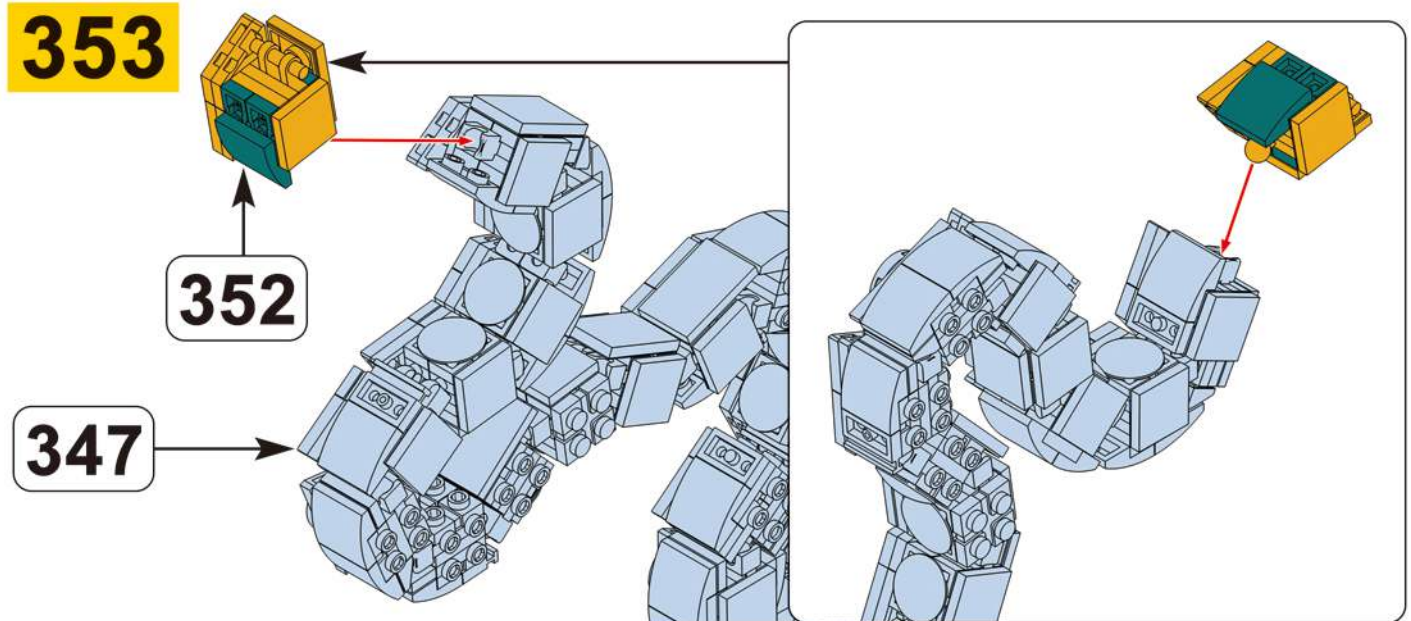

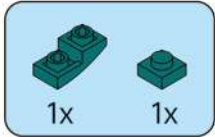

**354**

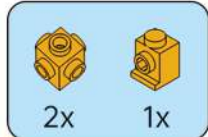
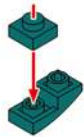

**355**

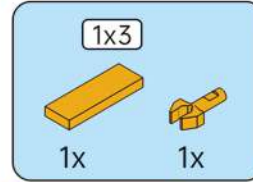
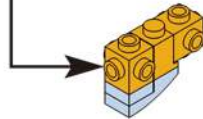
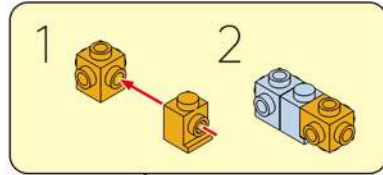

**356**

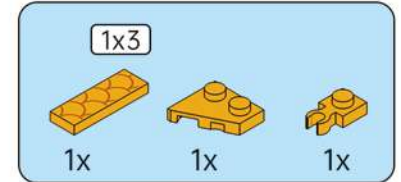
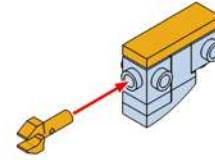

**357**

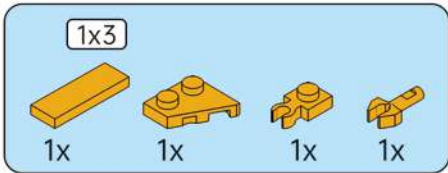
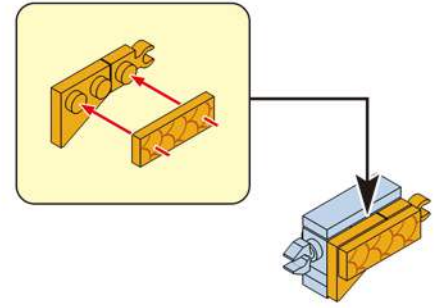

**358**

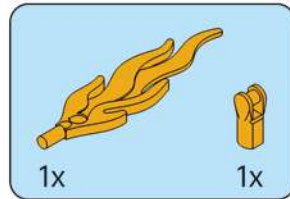
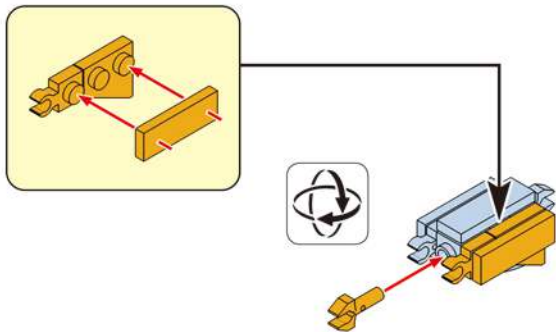

**359**

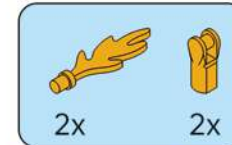
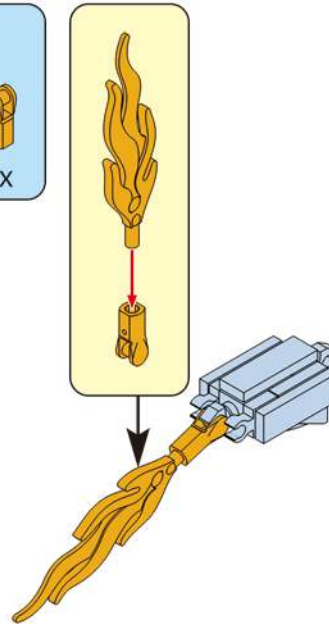

**360**

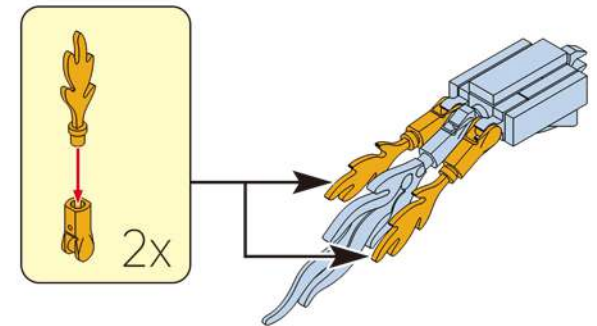

# 361

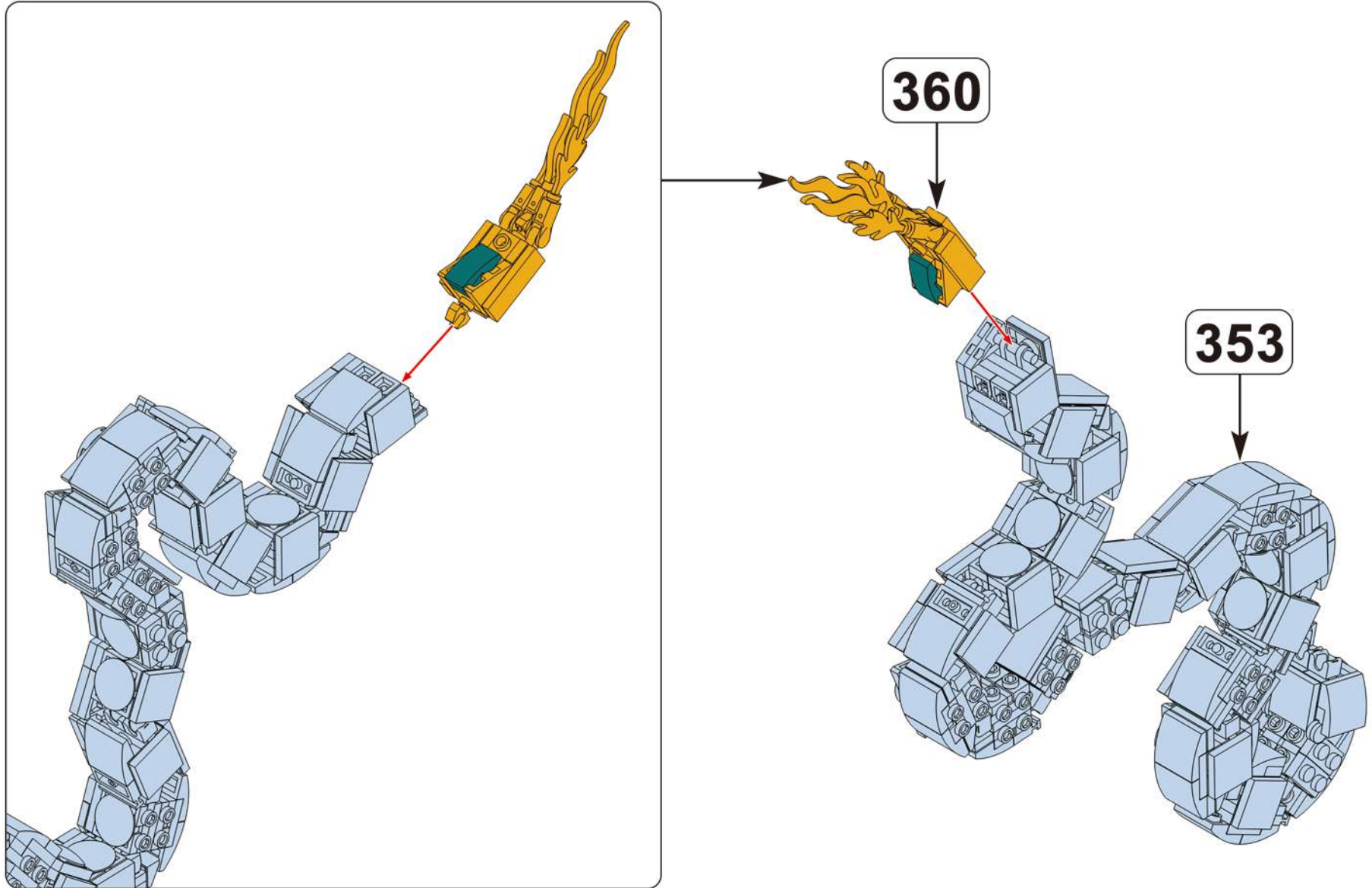

# JOY MAKES BRILLIANCE.

## Embrace Relaxation Embrace Joy

Every adultescent needs a "JOY BOX".  
Please, open your JOY BOX! Heading for joy.



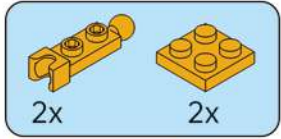

**362**

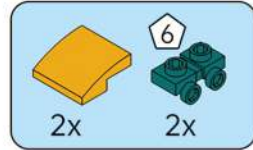

**363**

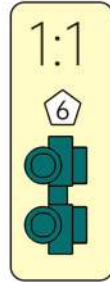
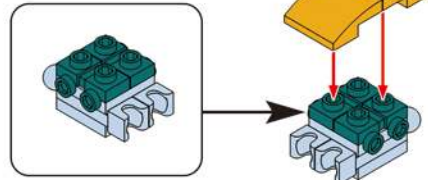

**364**

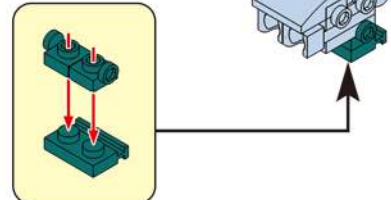

**365**

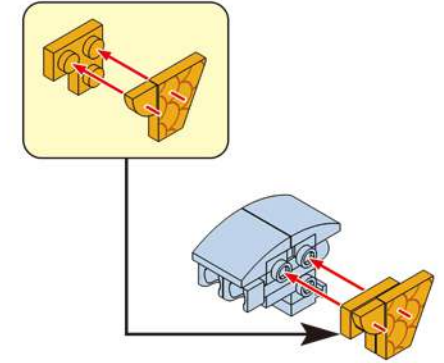

**366**

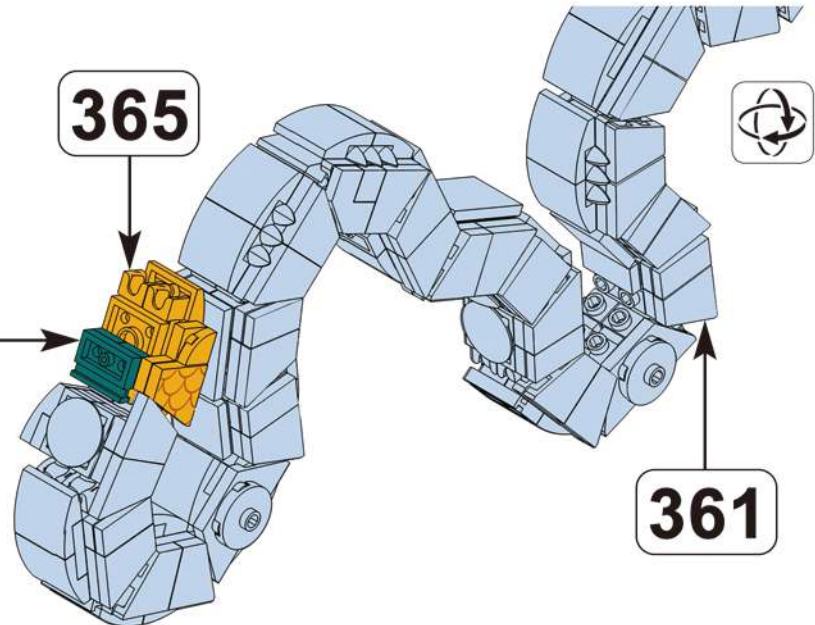
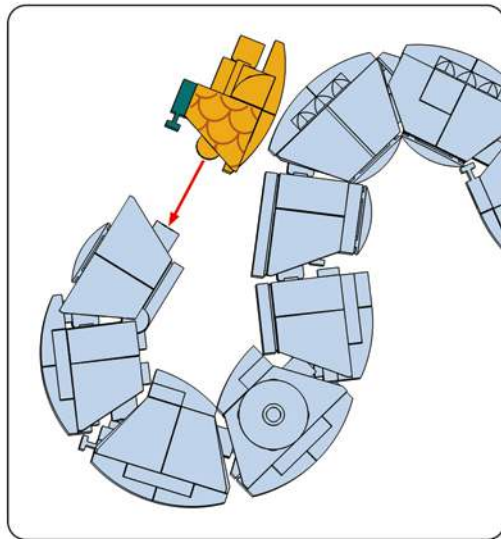

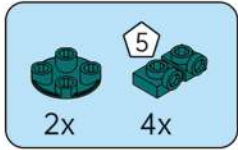

**367**

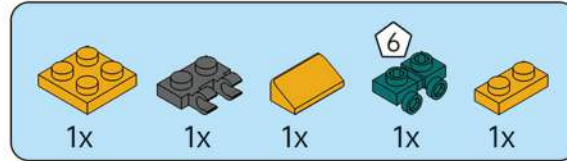
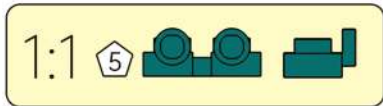
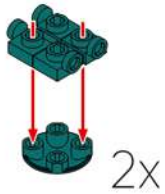

**368**

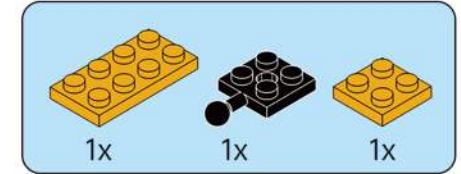
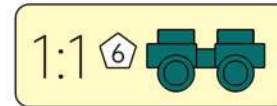
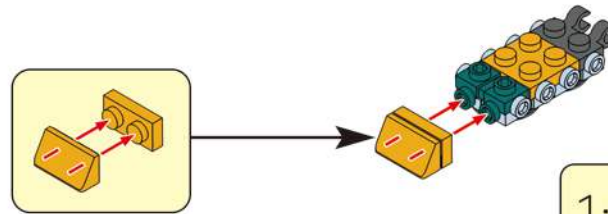

**369**

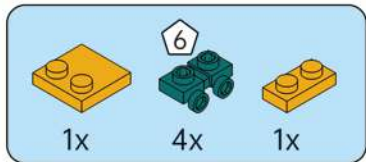
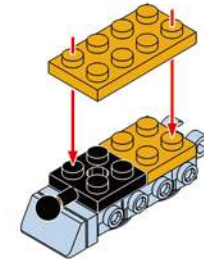

**370**

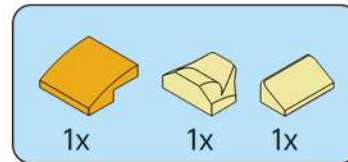
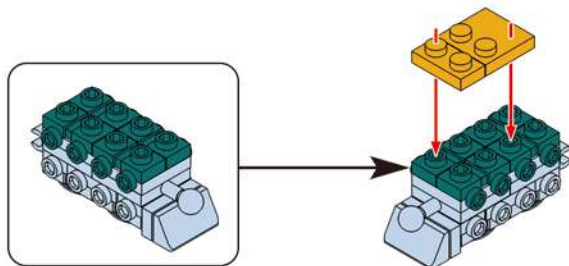

**371**

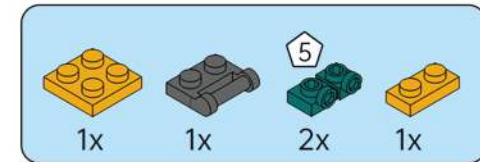
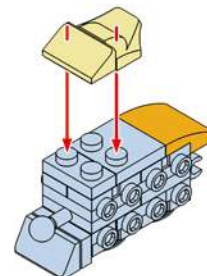

**372**

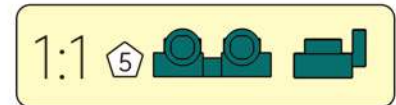
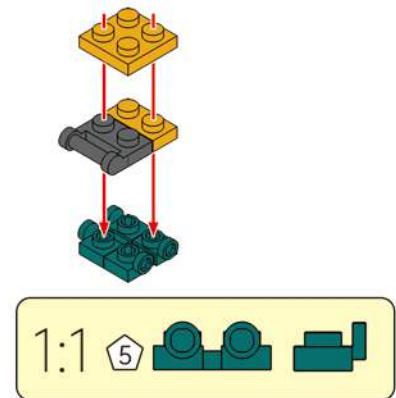

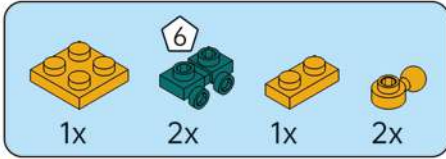

**373**

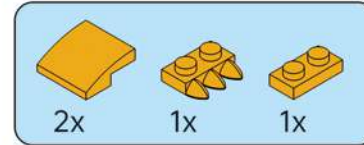
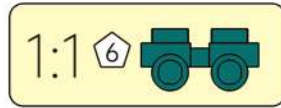
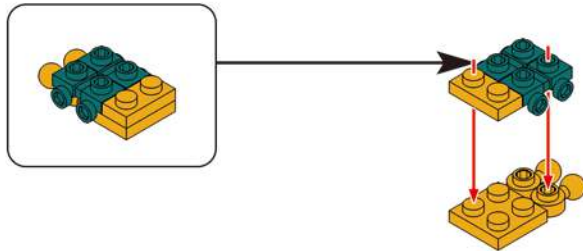

**374**

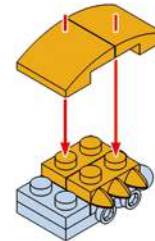

**375**

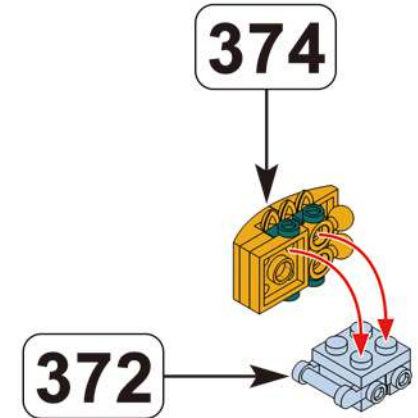

**376**

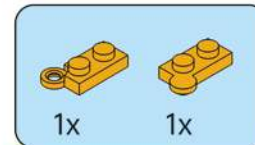
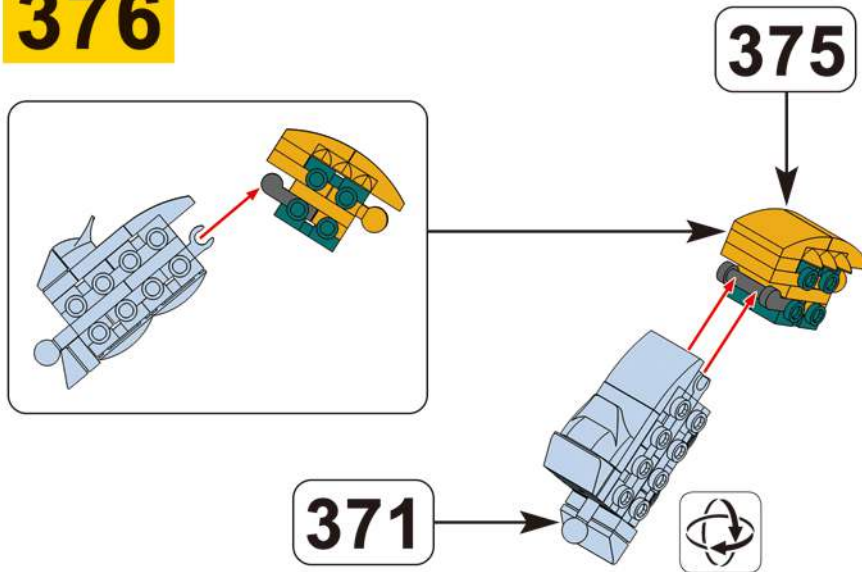

**377**

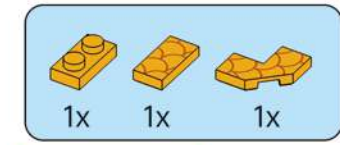
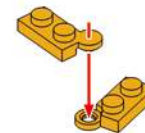

**378**

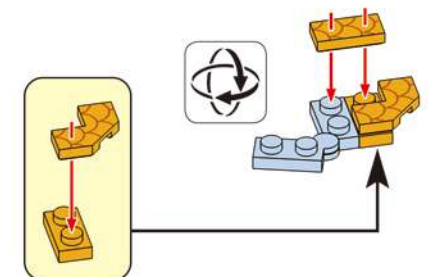

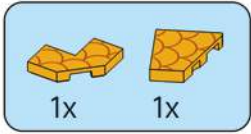

379

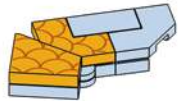

380

376

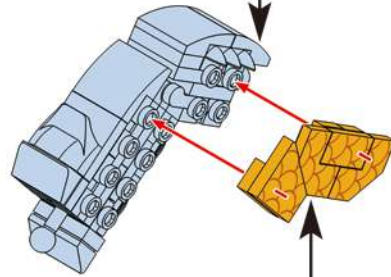

379

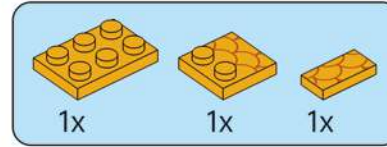

381

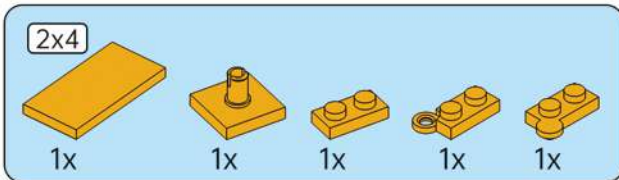
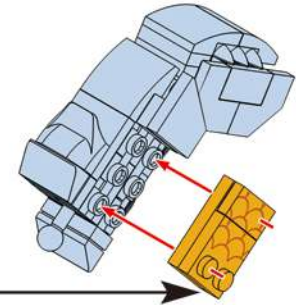
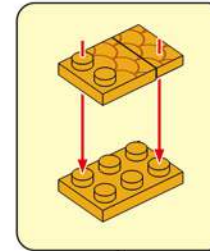

382

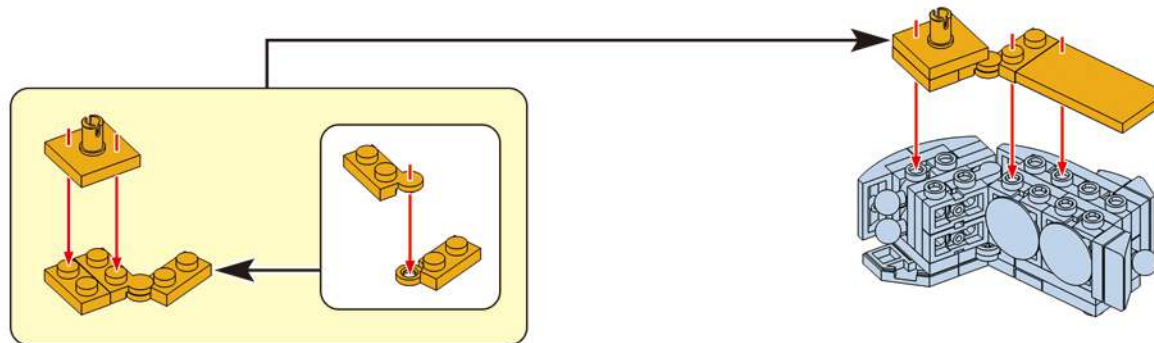

383

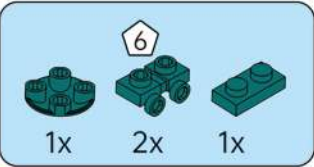
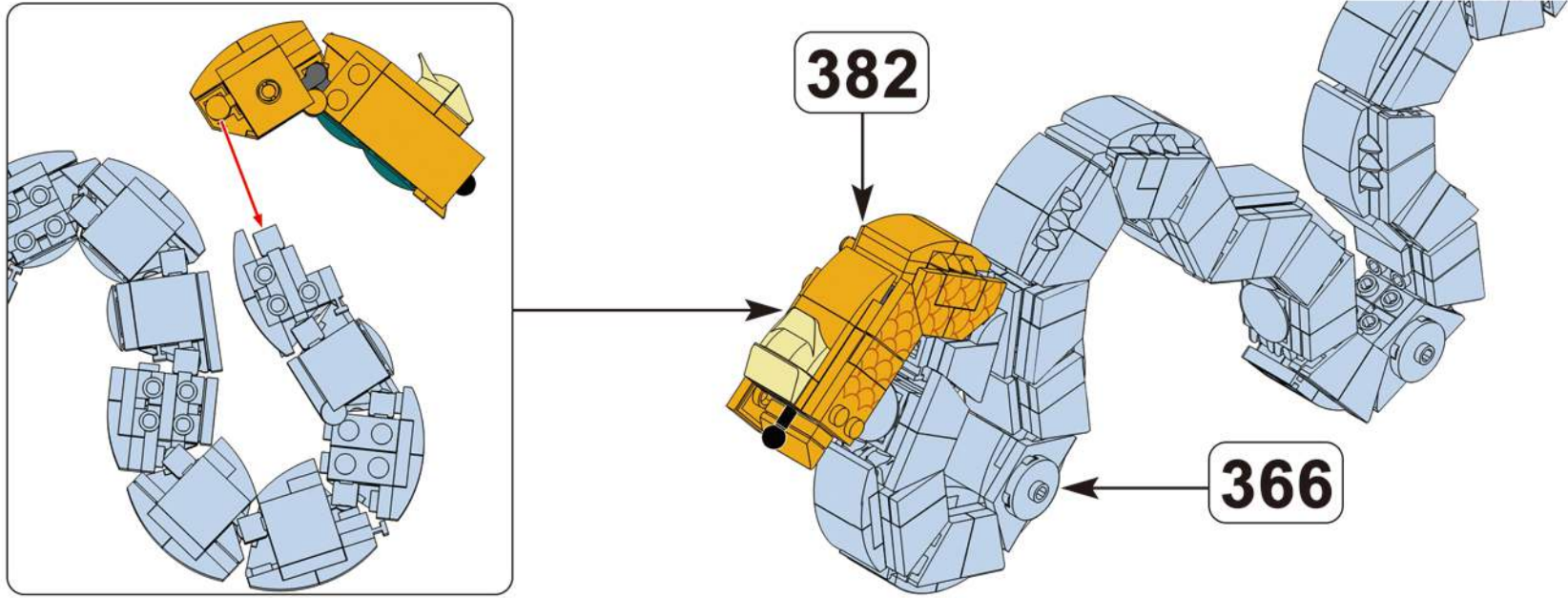

384

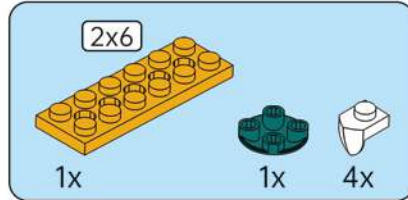
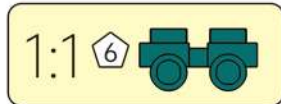
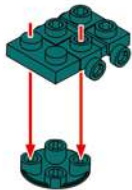

385

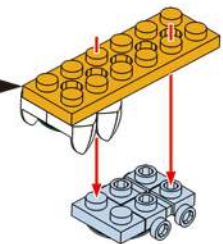
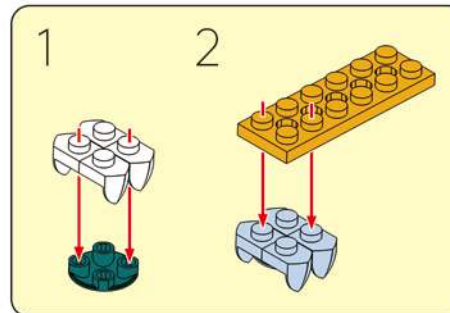

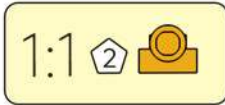
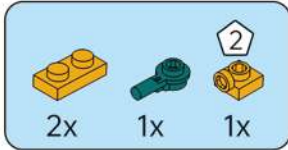

386

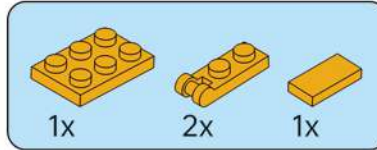
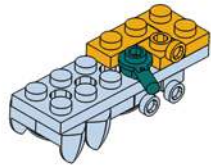

387

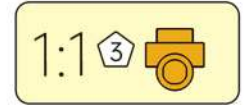
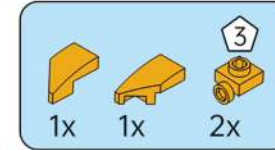
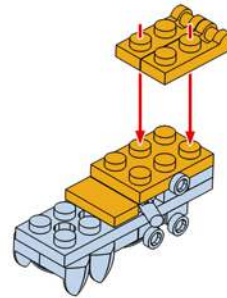

388

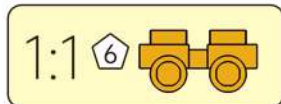
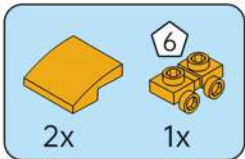
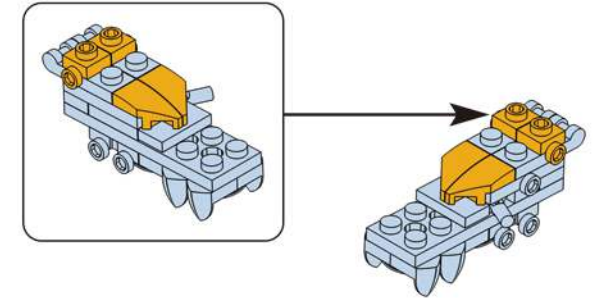

389

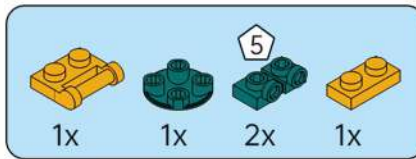
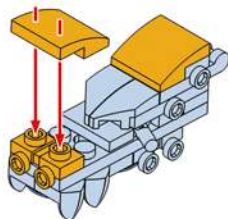

390

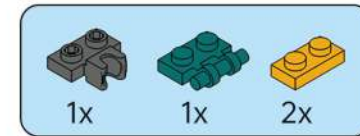
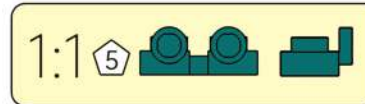
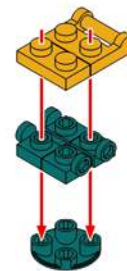

391

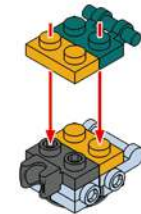

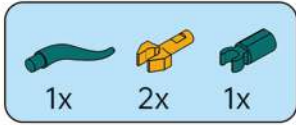

**392**

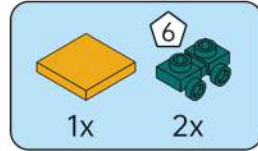
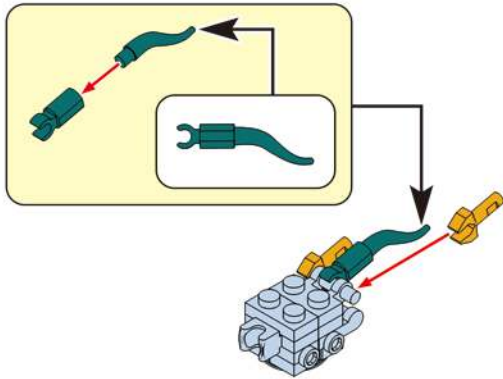

**393**

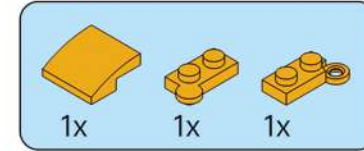
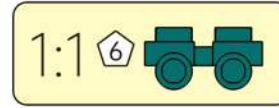
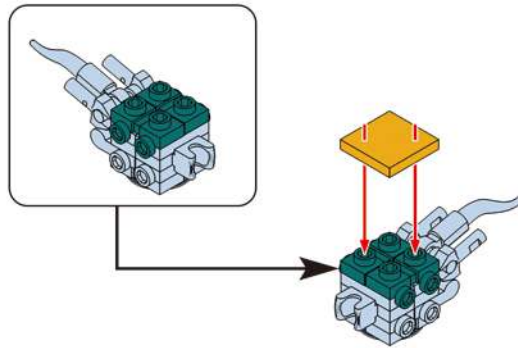

**394**

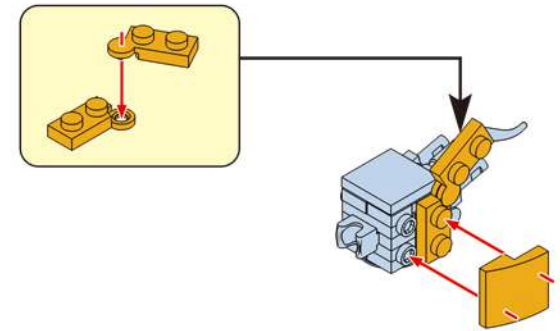

**395**

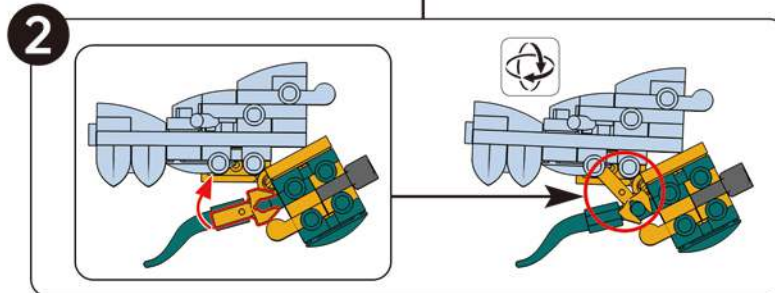
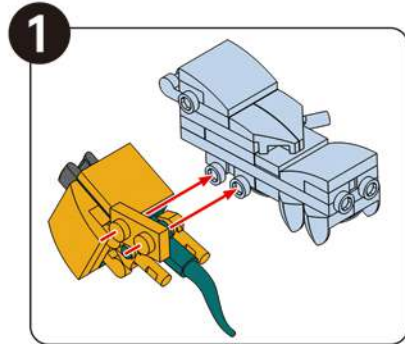

**389**

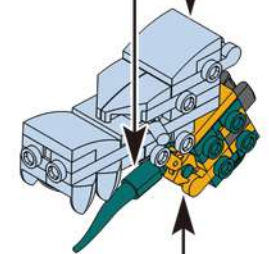

**394**

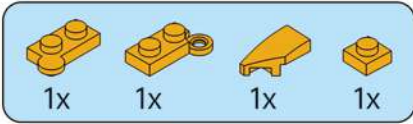

**396**

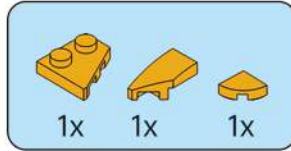
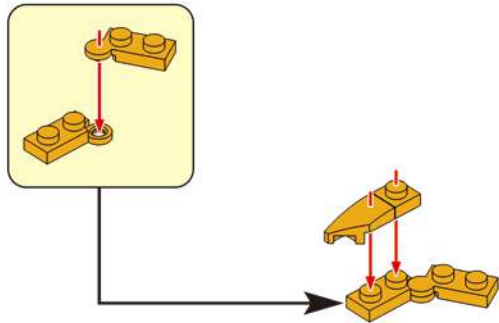

**397**

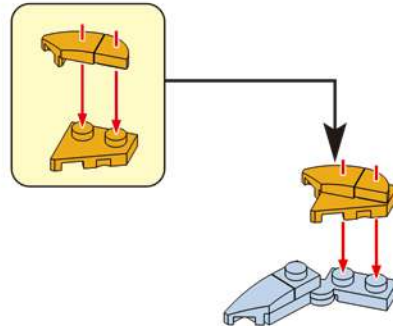

**398**

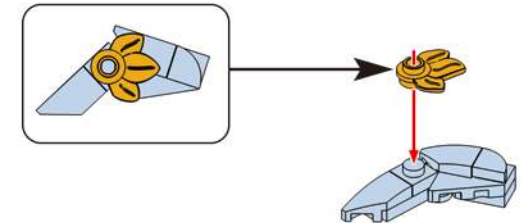

**399**

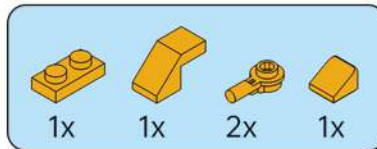
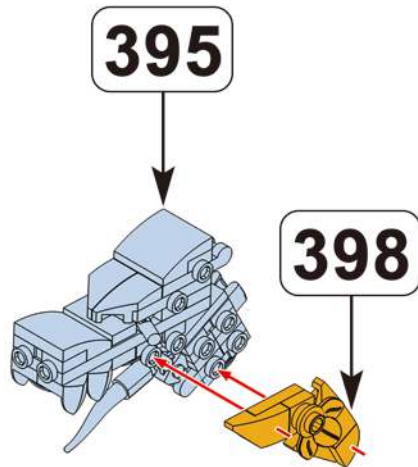

**400**

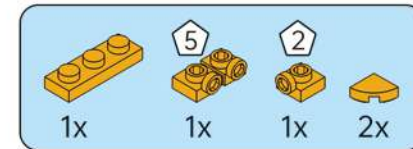
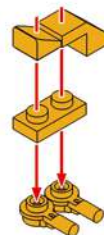

**401**

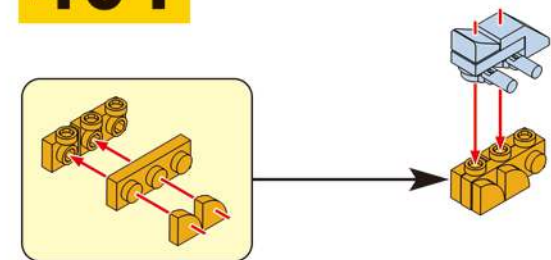

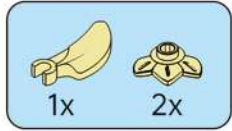

**402**

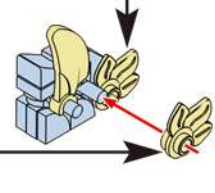
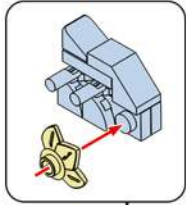

**403**



**402**

**399**

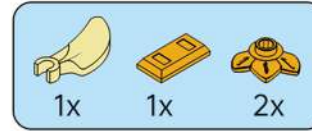
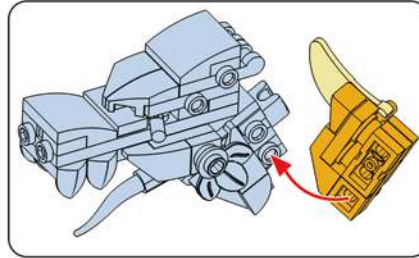
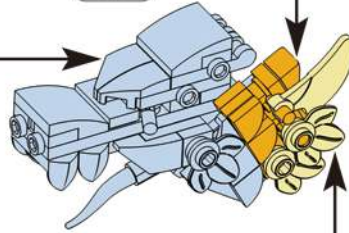

**404**

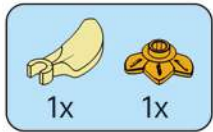
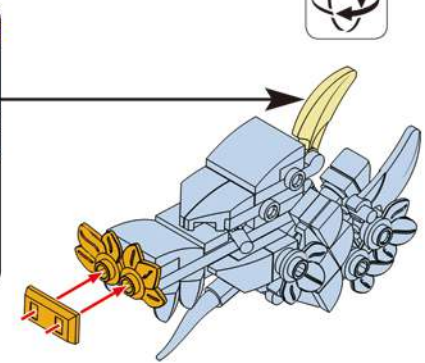
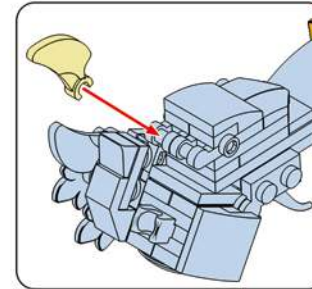

**405**

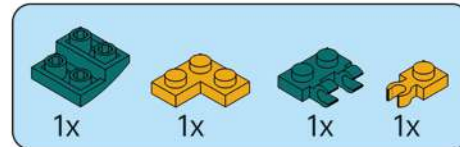
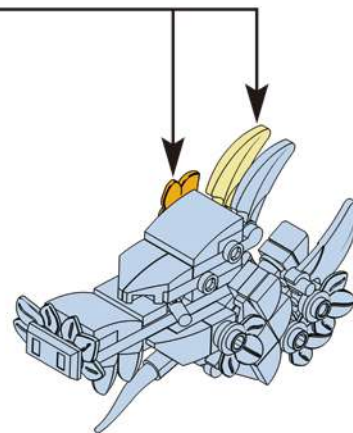
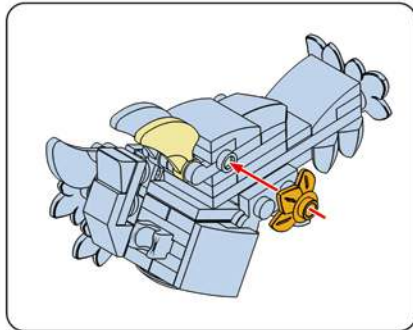

**406**

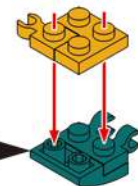
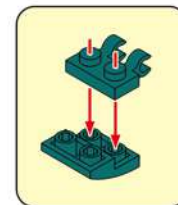

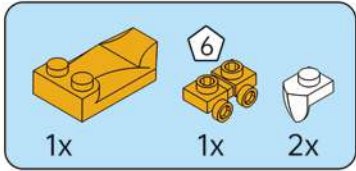

**407**

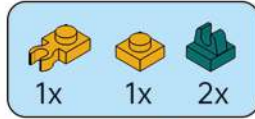
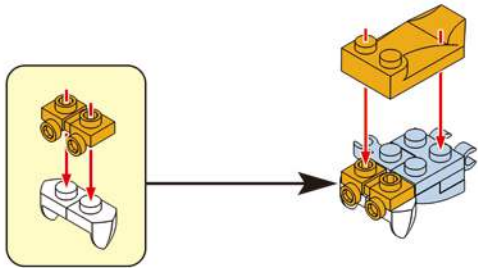
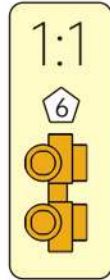

**408**

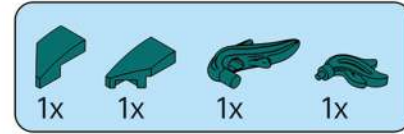
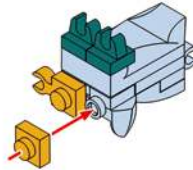

**409**

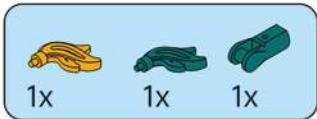
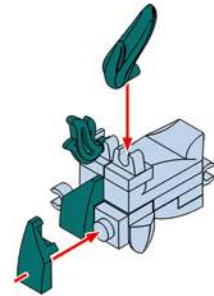

**410**

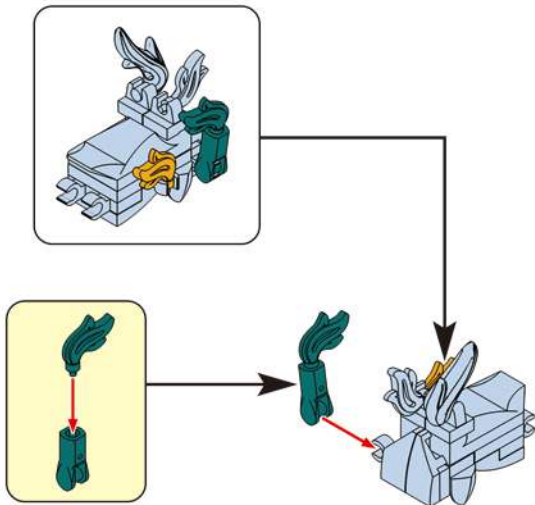

**411**

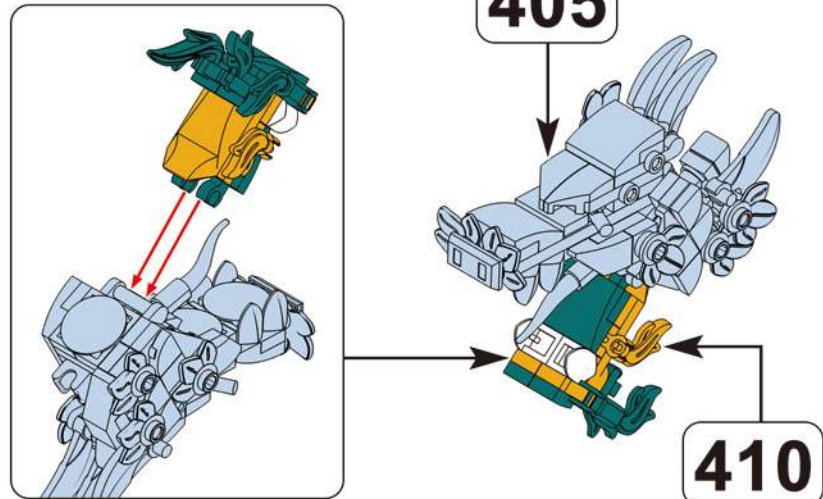

412

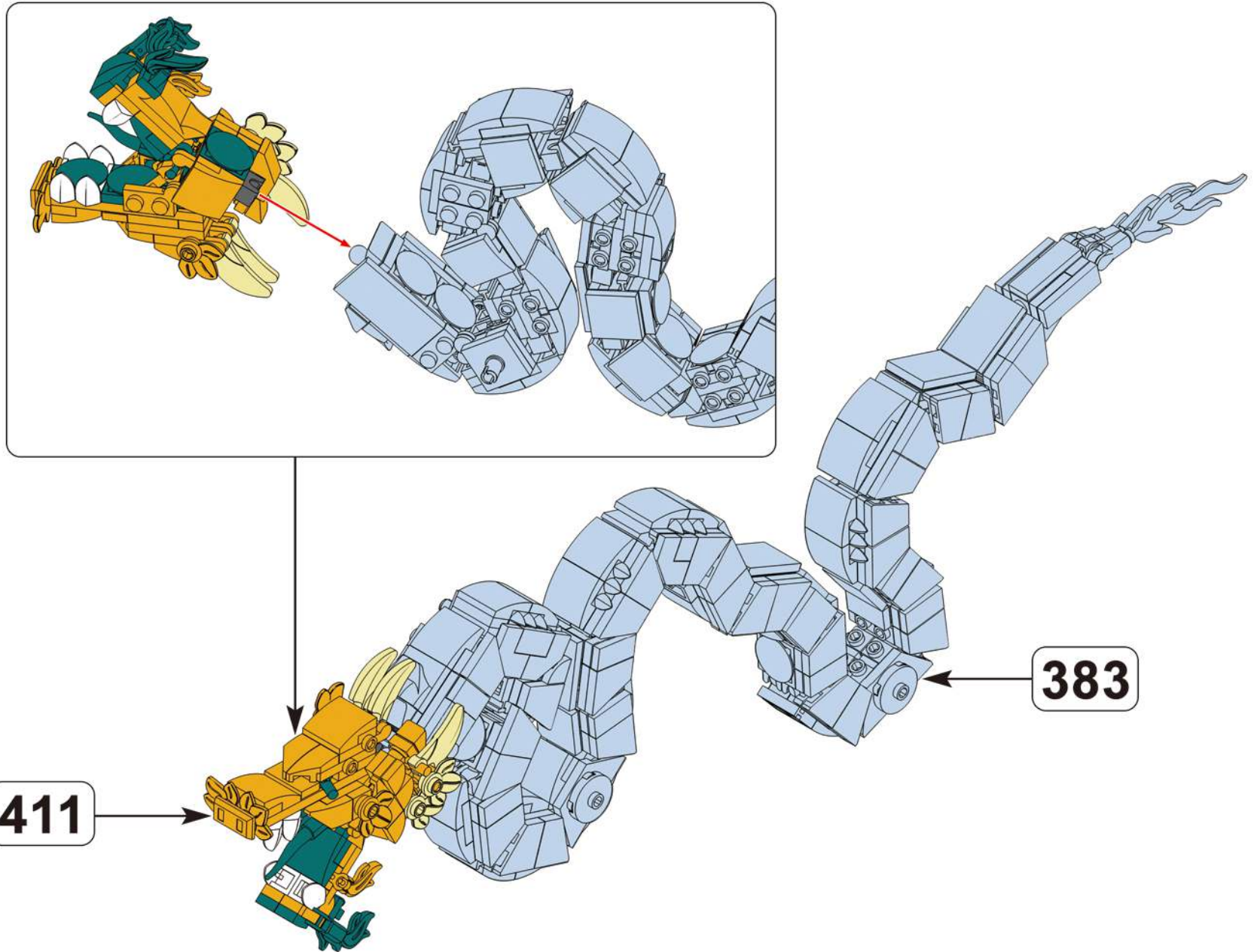

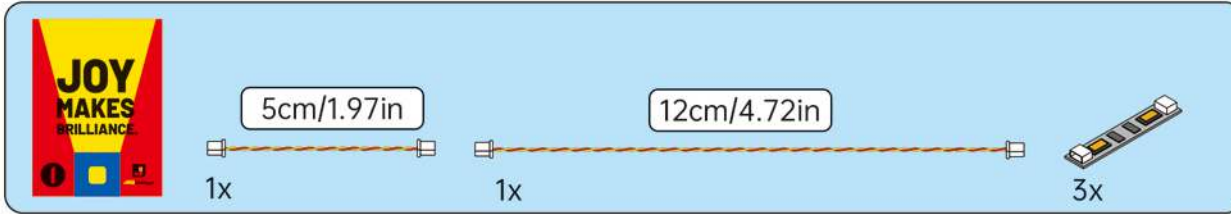

# 413

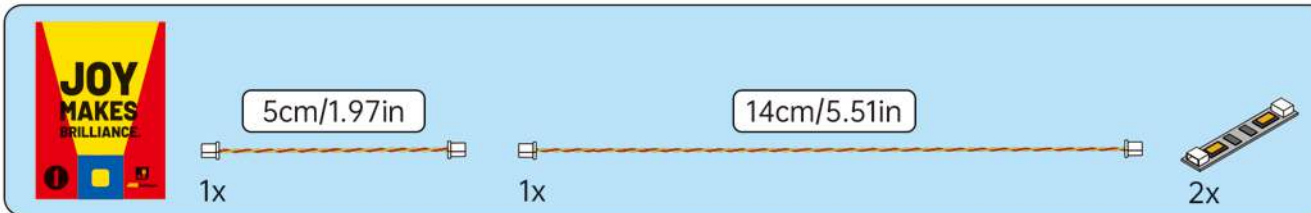
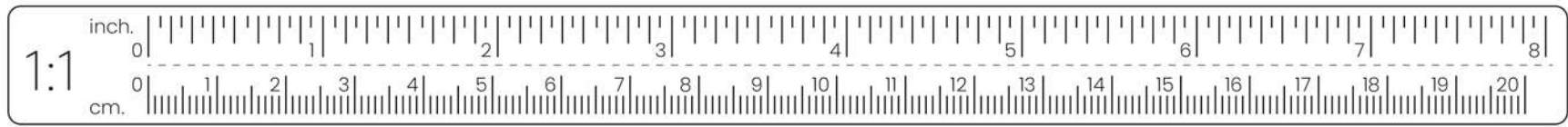

# 414

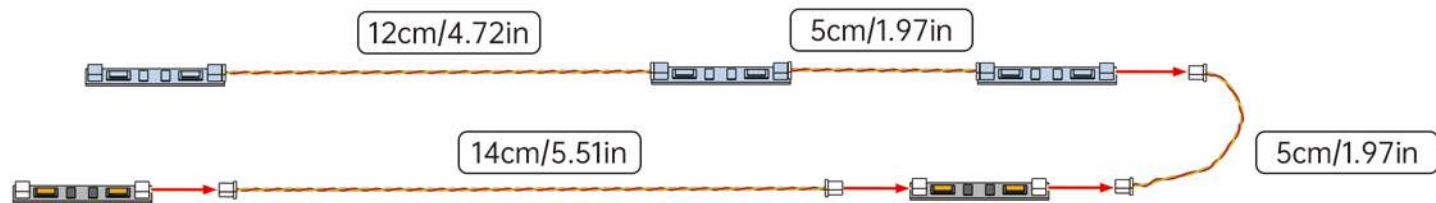

415

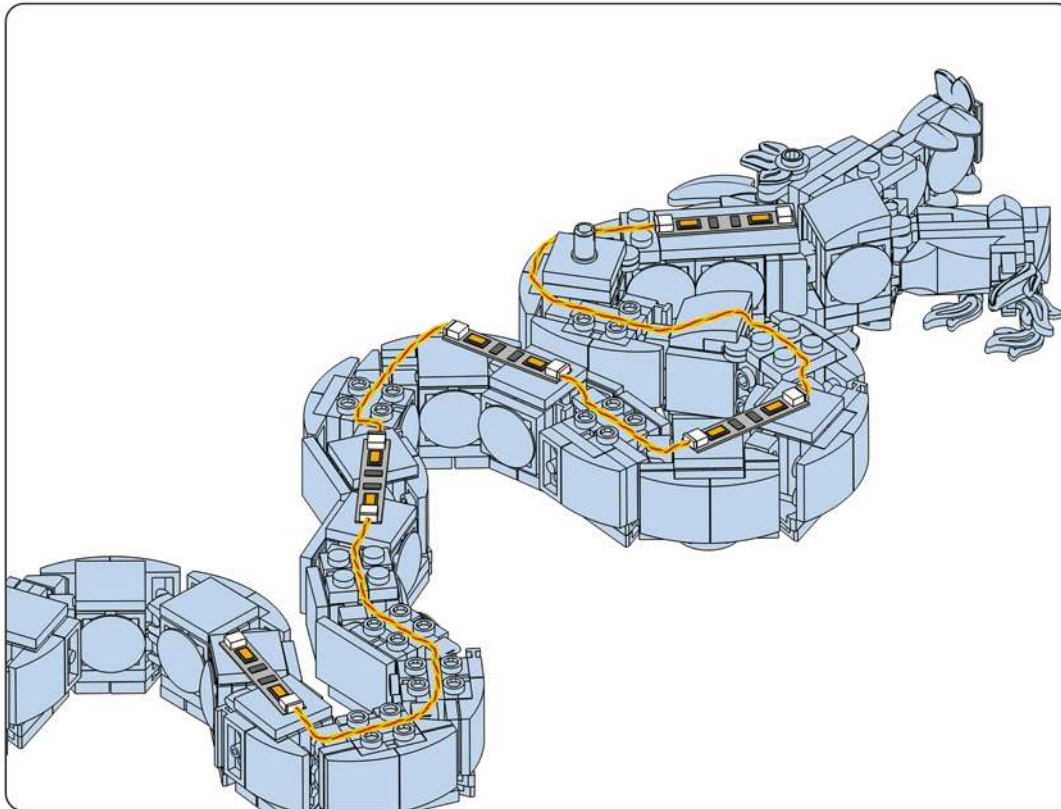

Tear off the double-sided tape for pasting  
 Reißen Sie das doppelseitige Klebeband zum Aufkleben ab

414

14cm/5.51in

5cm/1.97in

5cm/1.97in

12cm/4.72in

412



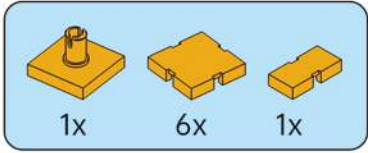

# 416

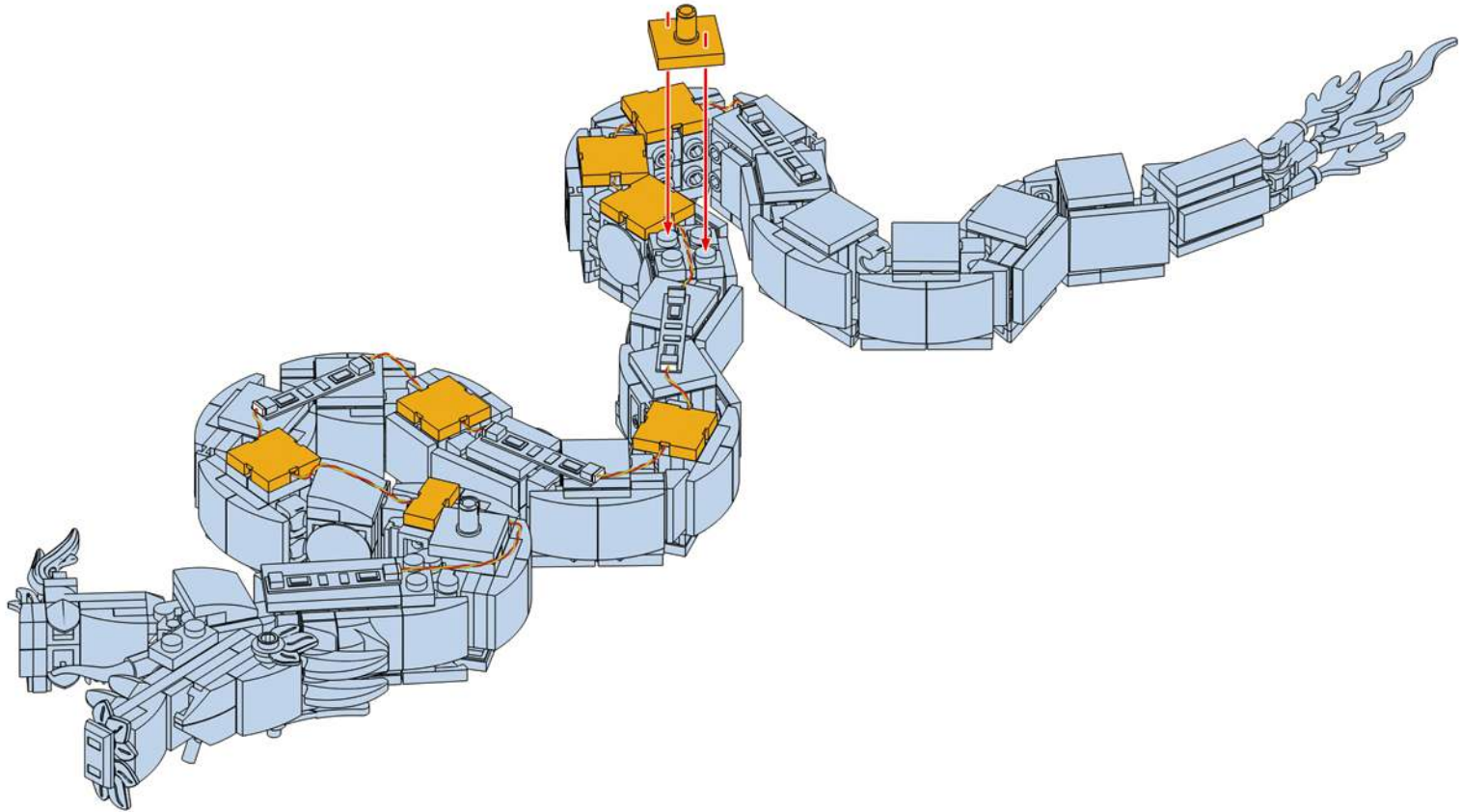

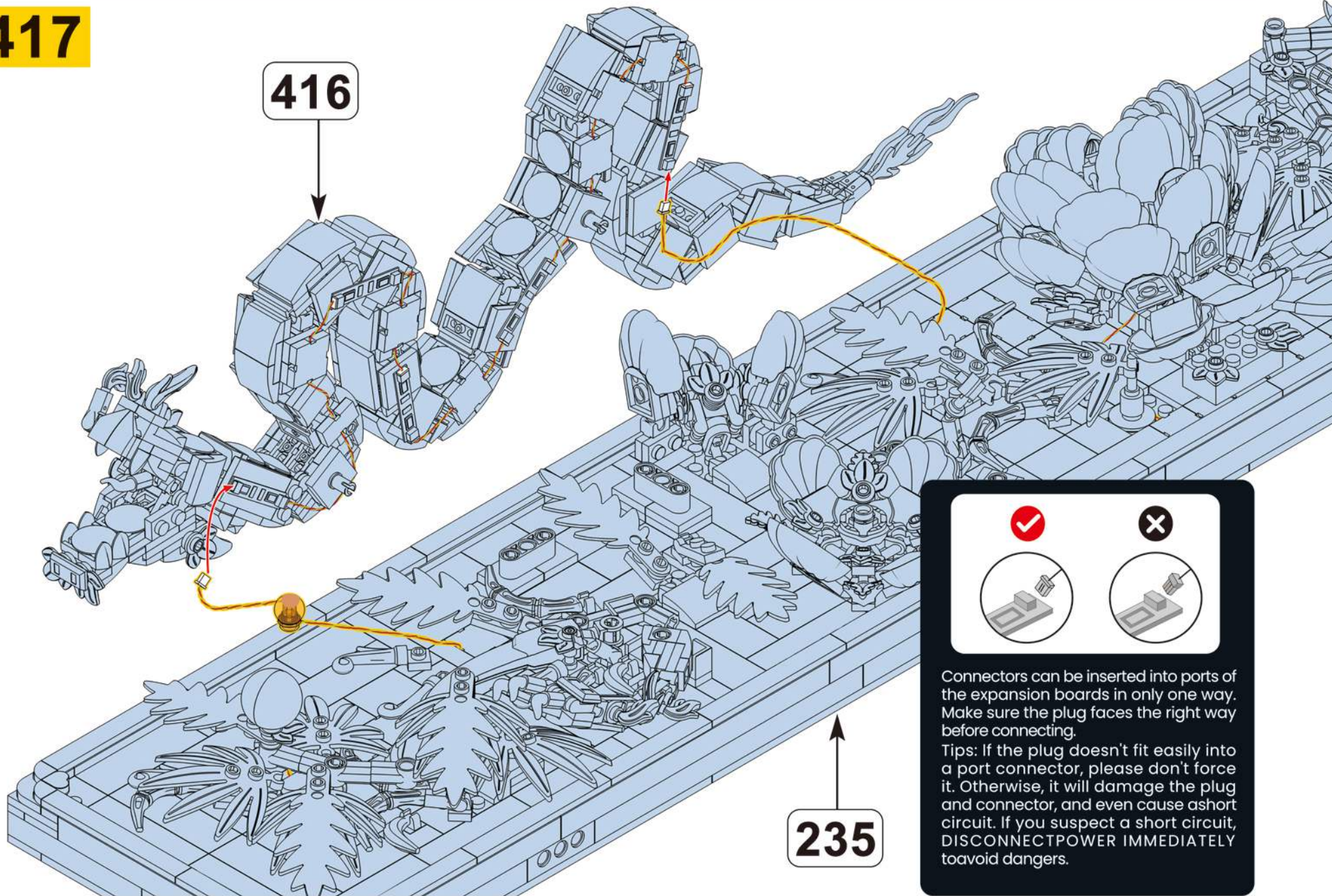

417

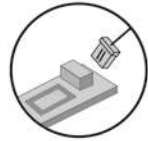

416

235



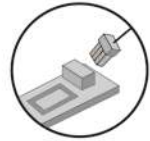

Connectors can be inserted into ports of the expansion boards in only one way. Make sure the plug faces the right way before connecting.

Tips: If the plug doesn't fit easily into a port connector, please don't force it. Otherwise, it will damage the plug and connector, and even cause a short circuit. If you suspect a short circuit, DISCONNECT POWER IMMEDIATELY to avoid dangers.

418

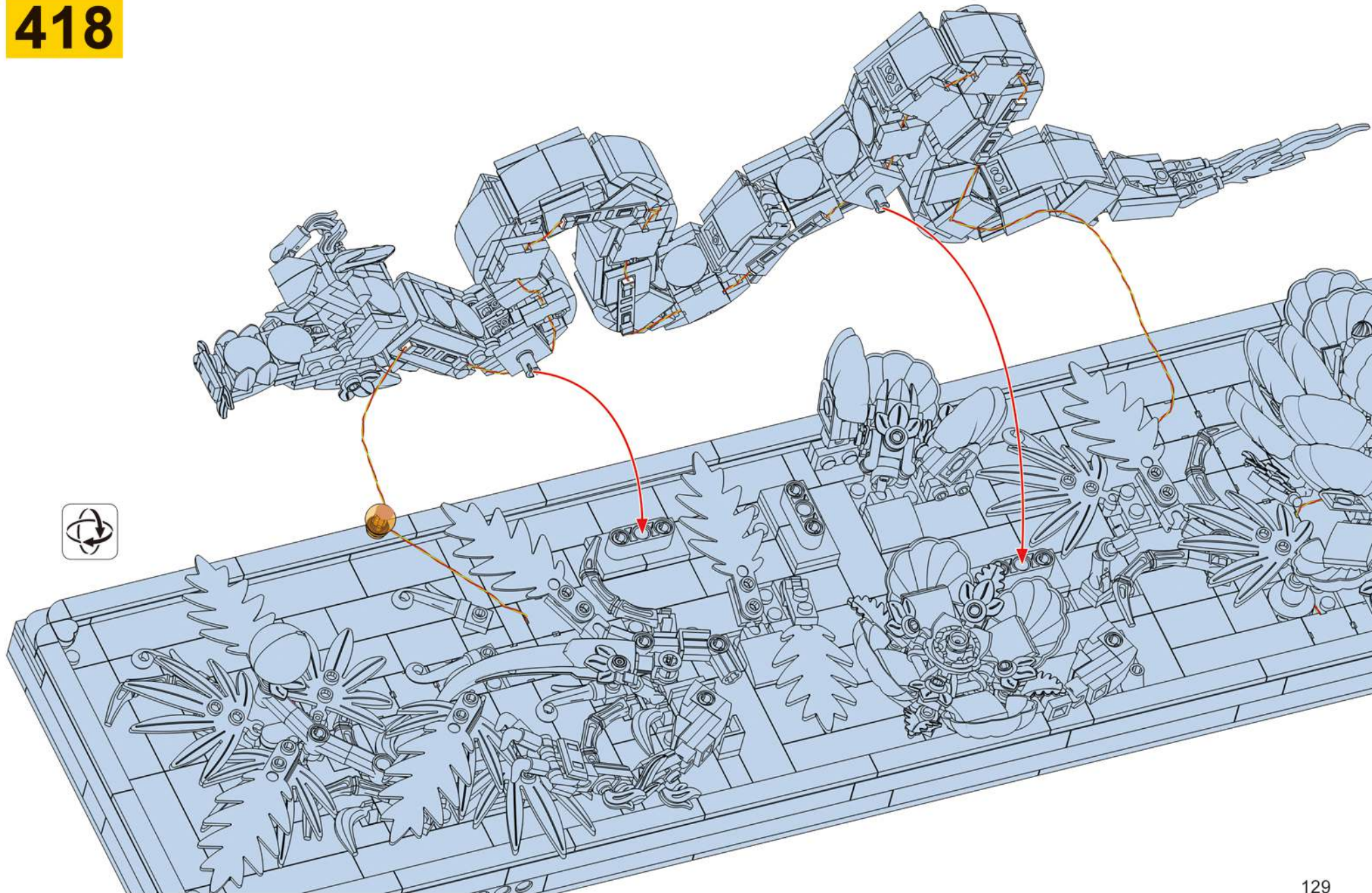

**419**

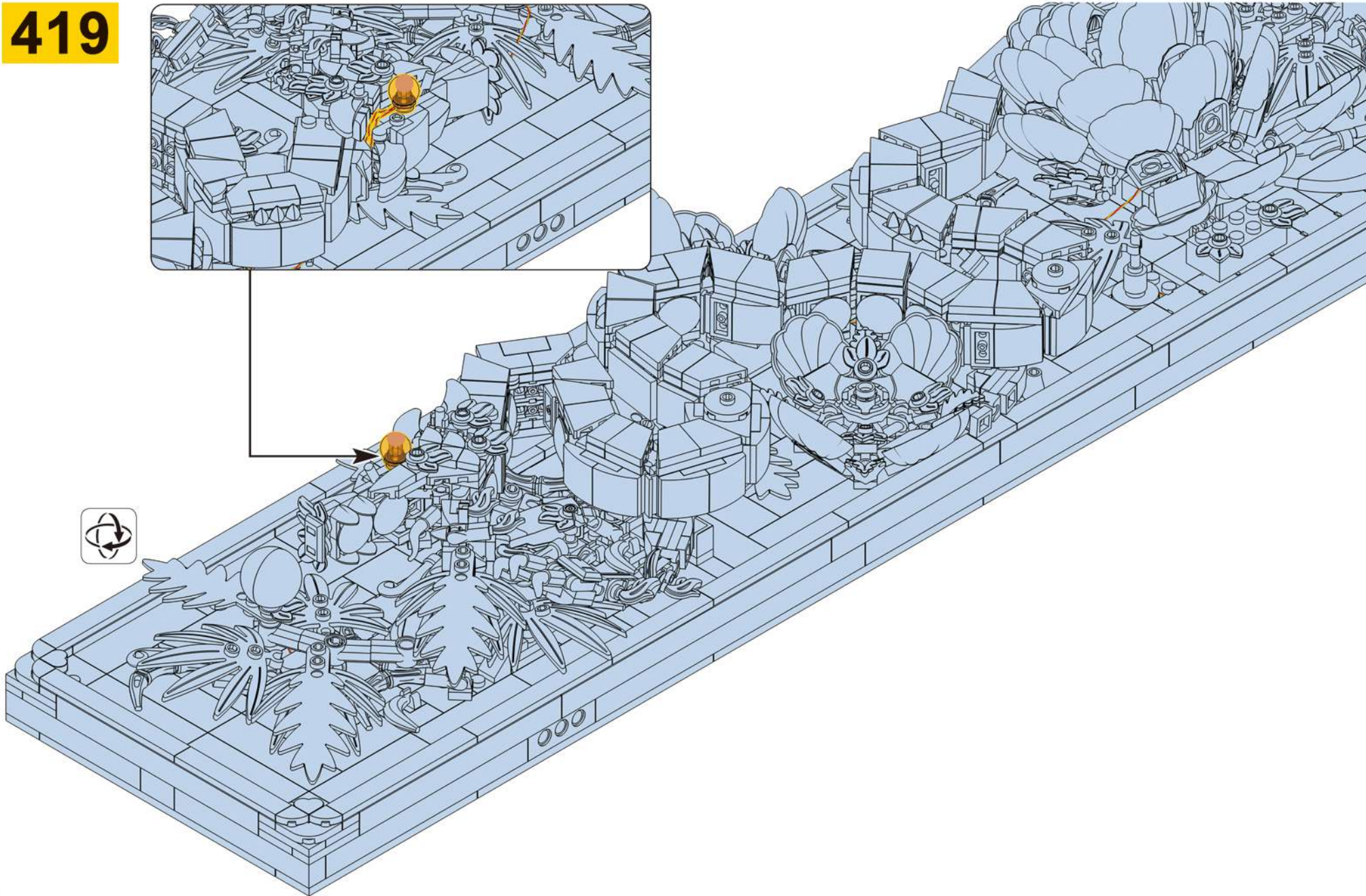
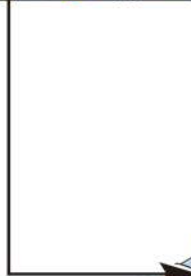
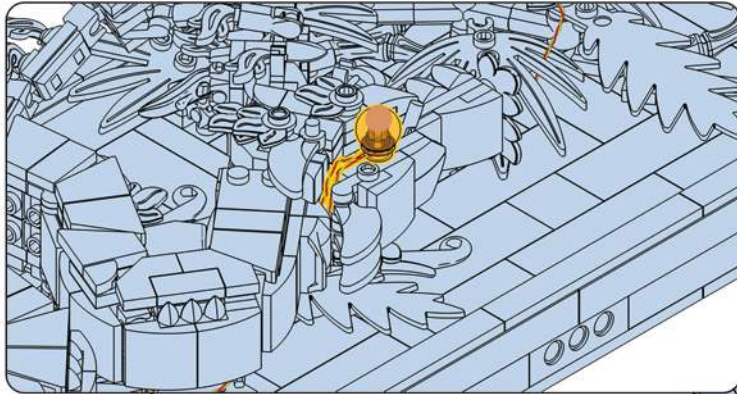

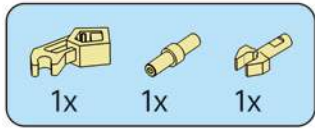

# 420

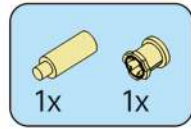
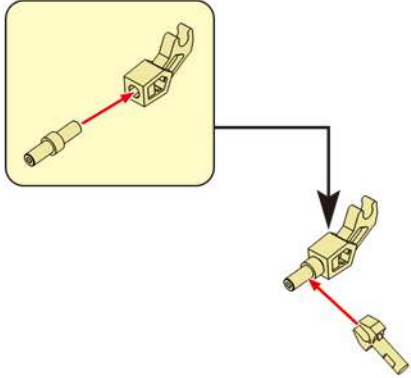

# 421

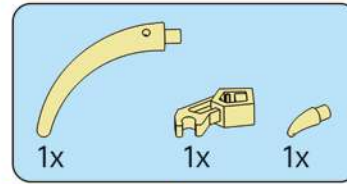
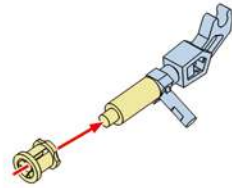

# 422

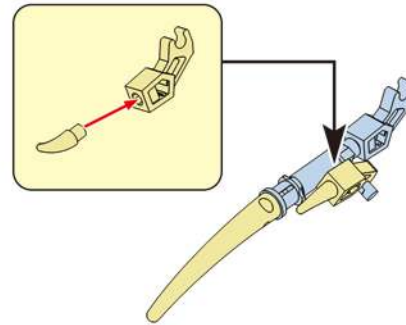

# 423

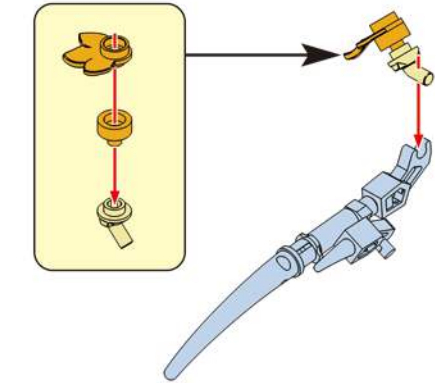

# 424

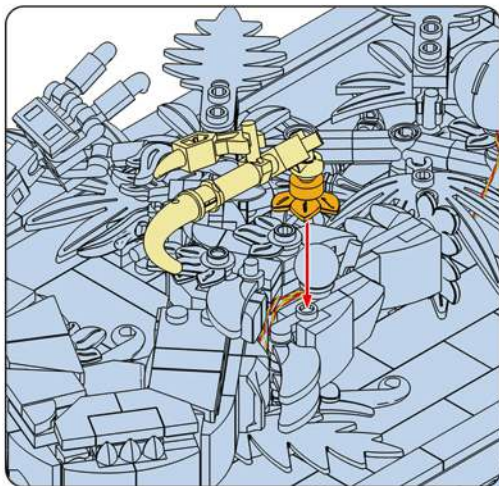

# 423

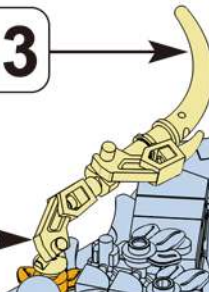

# 419

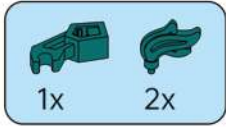

**425**

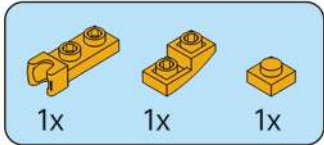
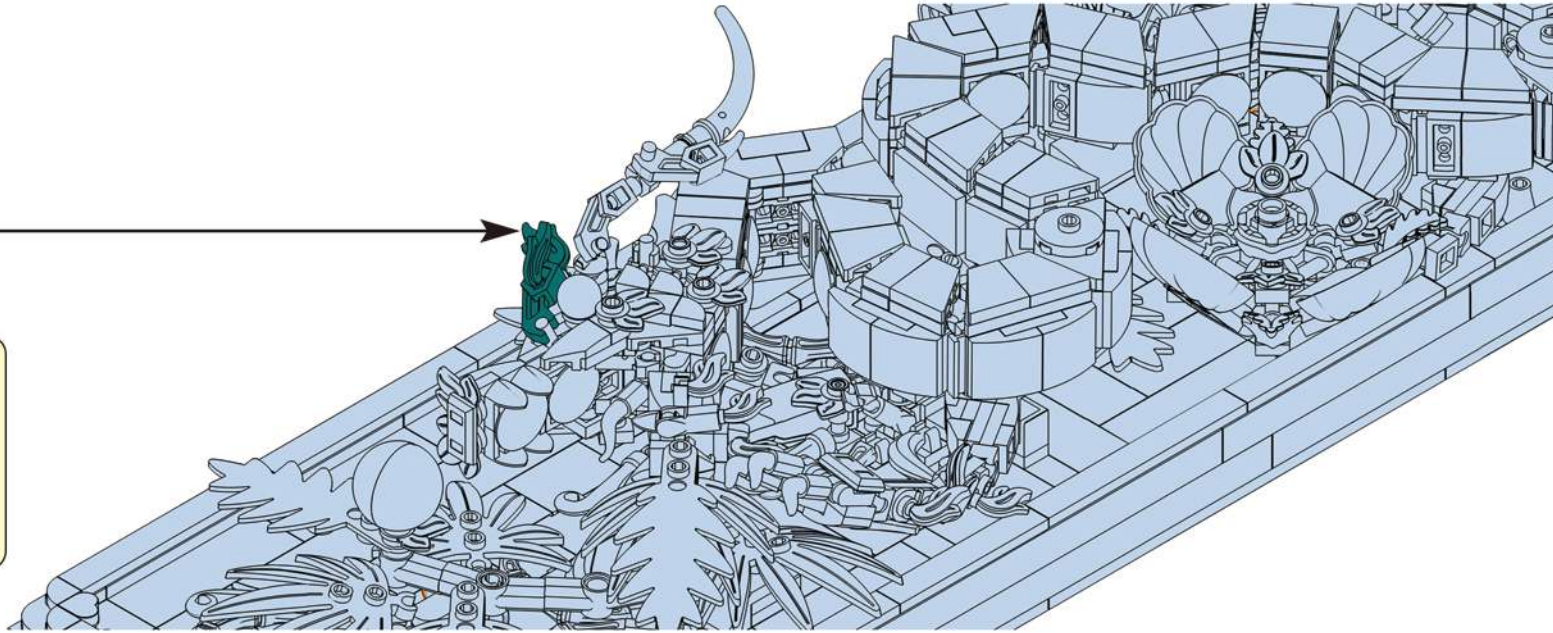
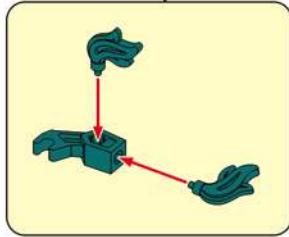

**426**

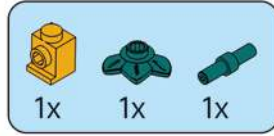
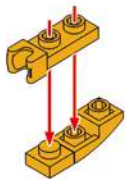

**427**

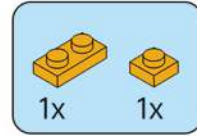
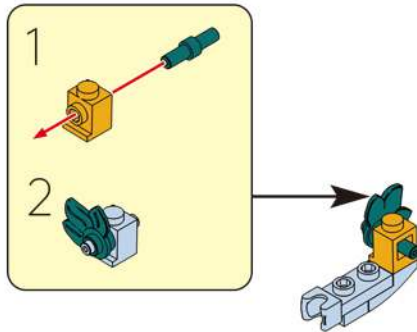

**428**

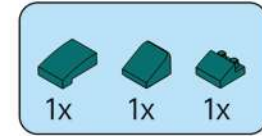
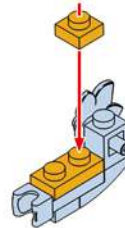

**429**

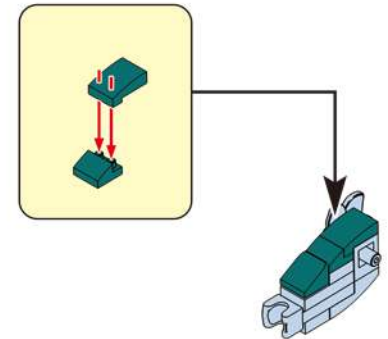

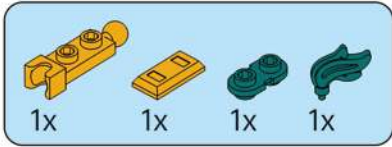

**430**

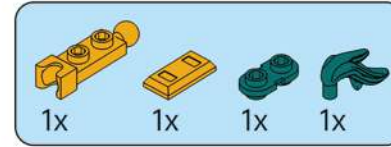
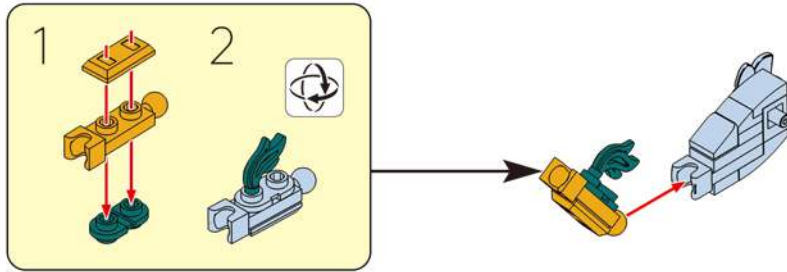

**431**

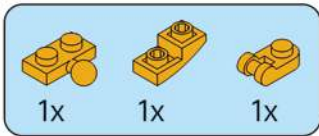
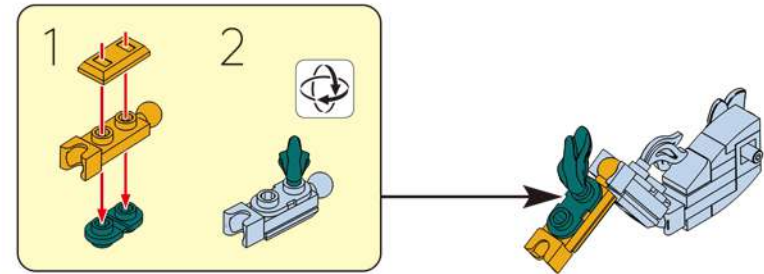

**432**

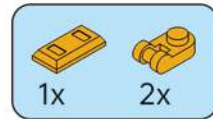
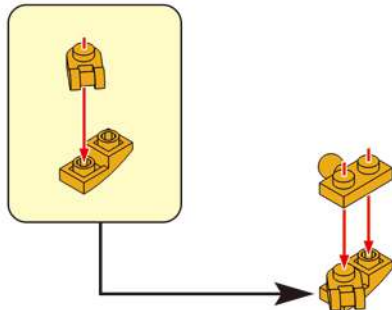

**433**

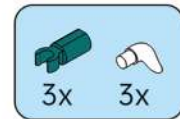
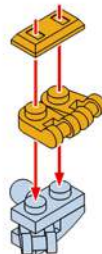

**434**

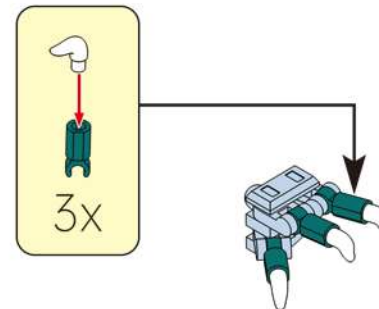

**435**

**431**

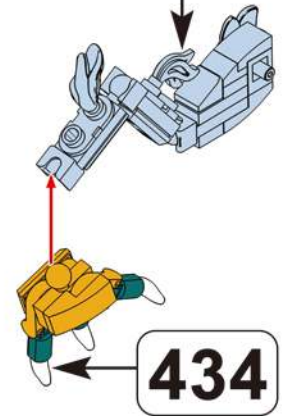

**434**

436

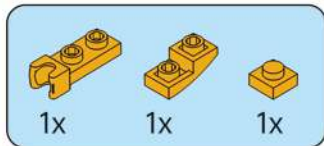
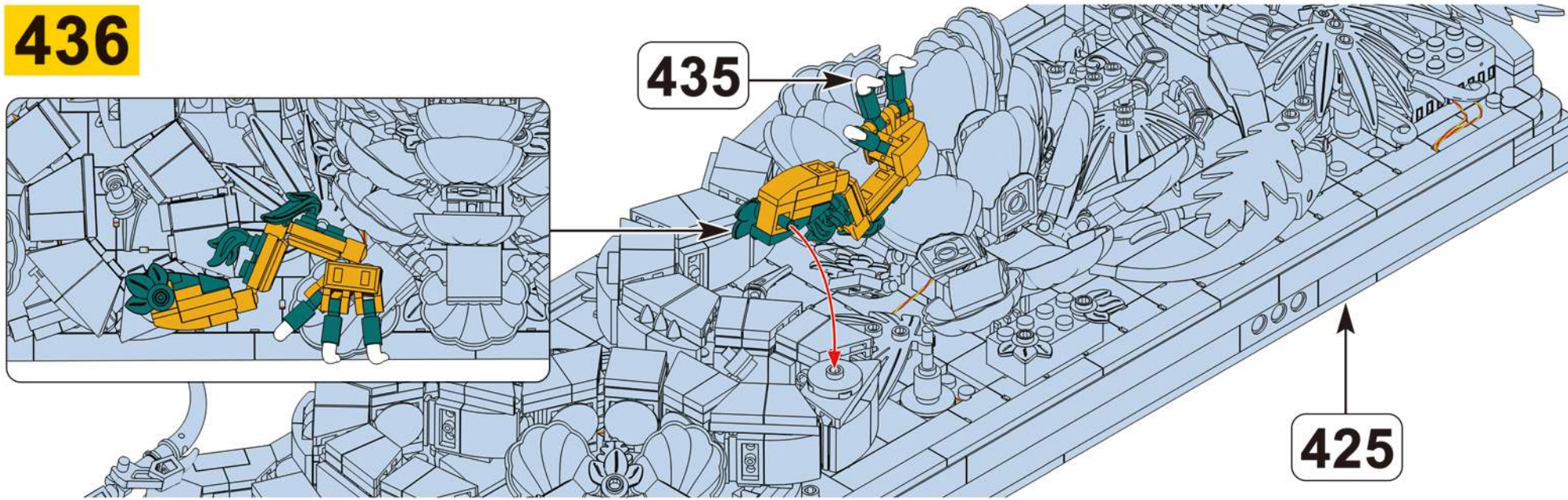

437

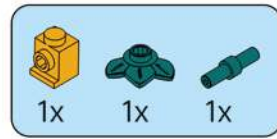
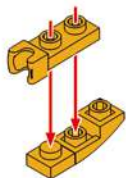

438

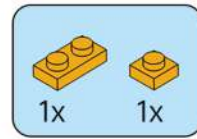
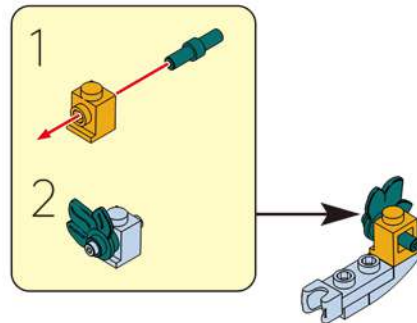

439

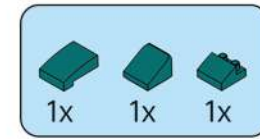
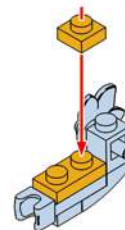

440

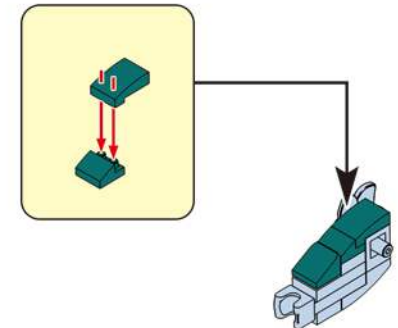

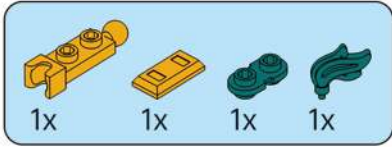

**441**

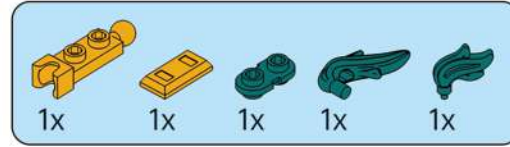
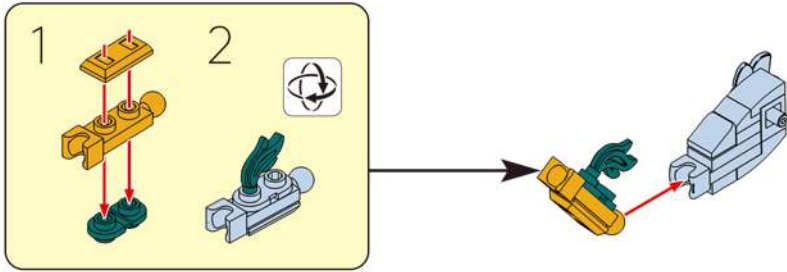

**442**

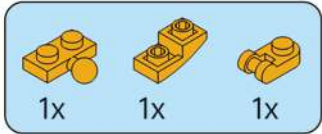
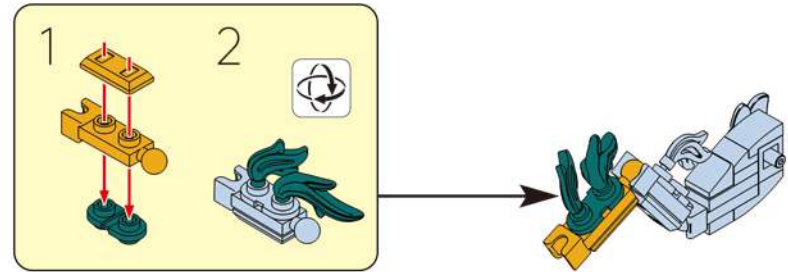

**443**

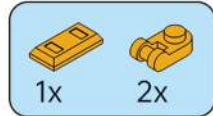
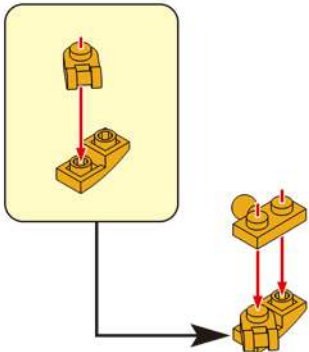

**444**

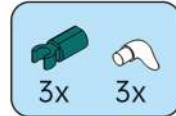
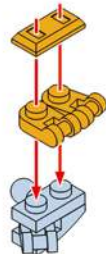

**445**

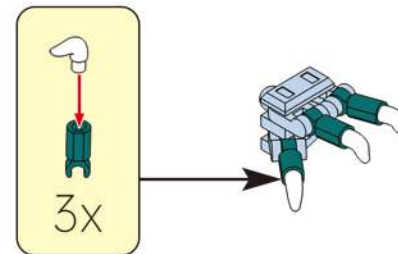

**446**

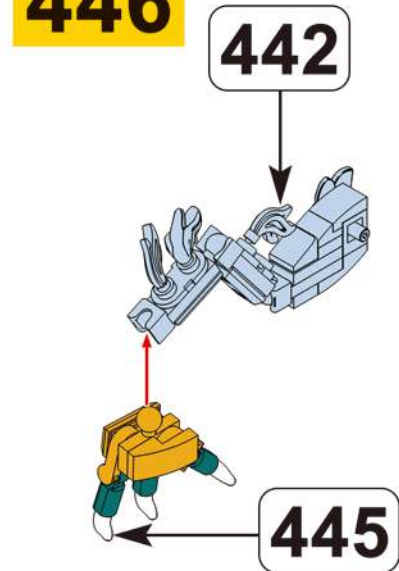

447

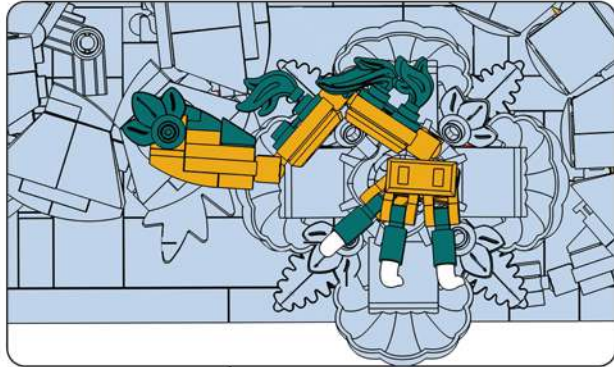

446

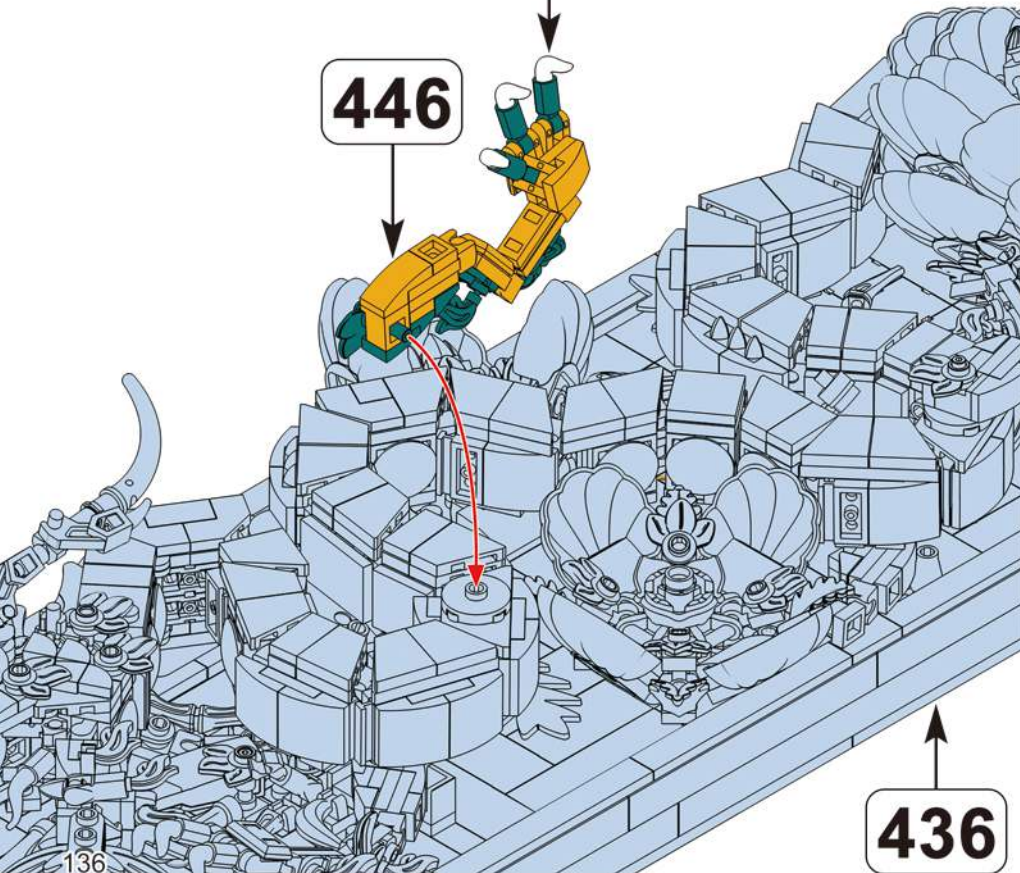

436

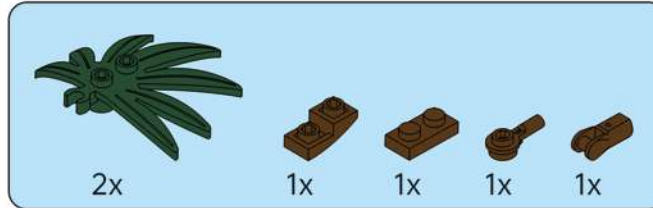

448

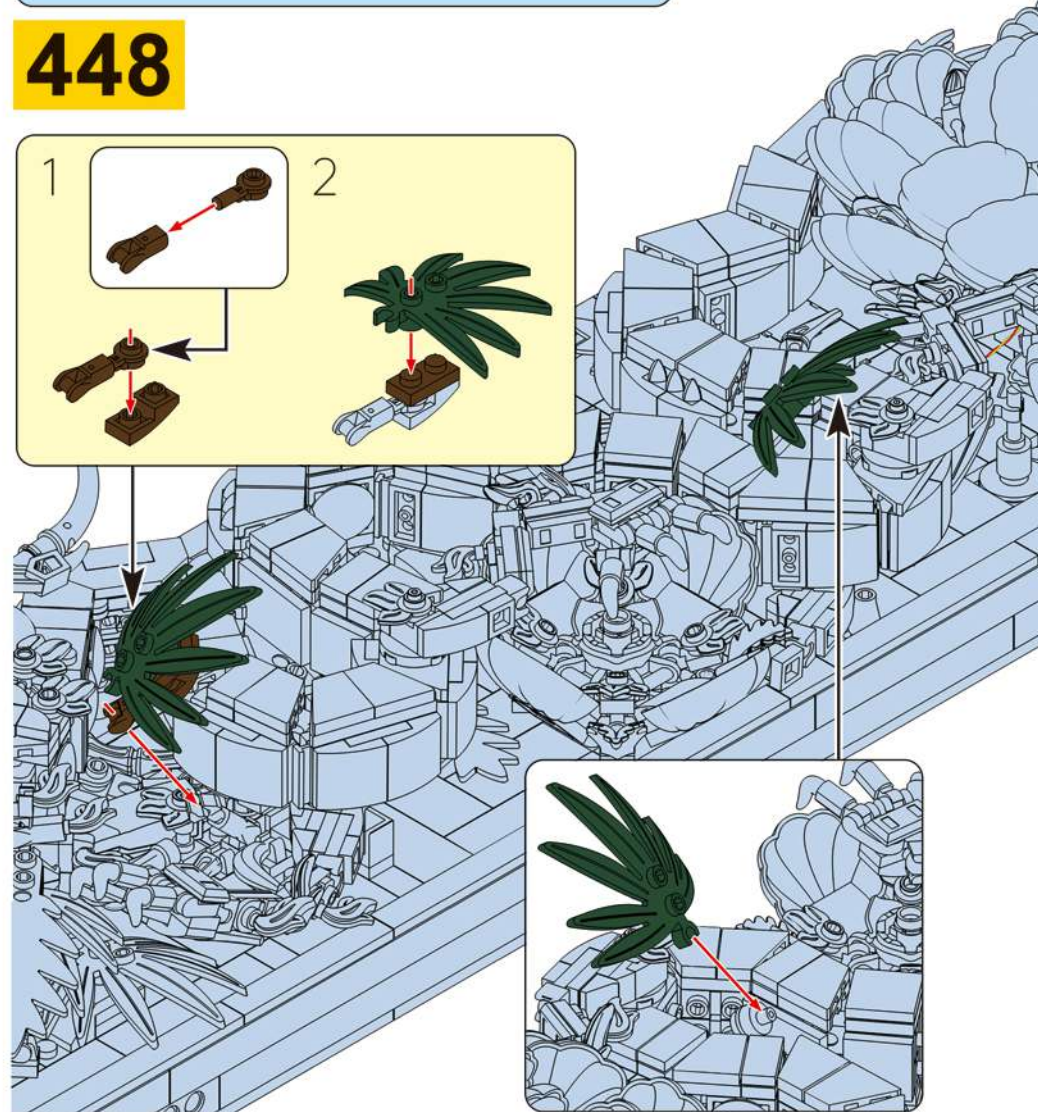
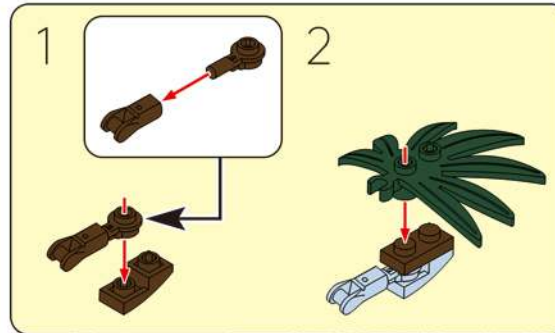



449

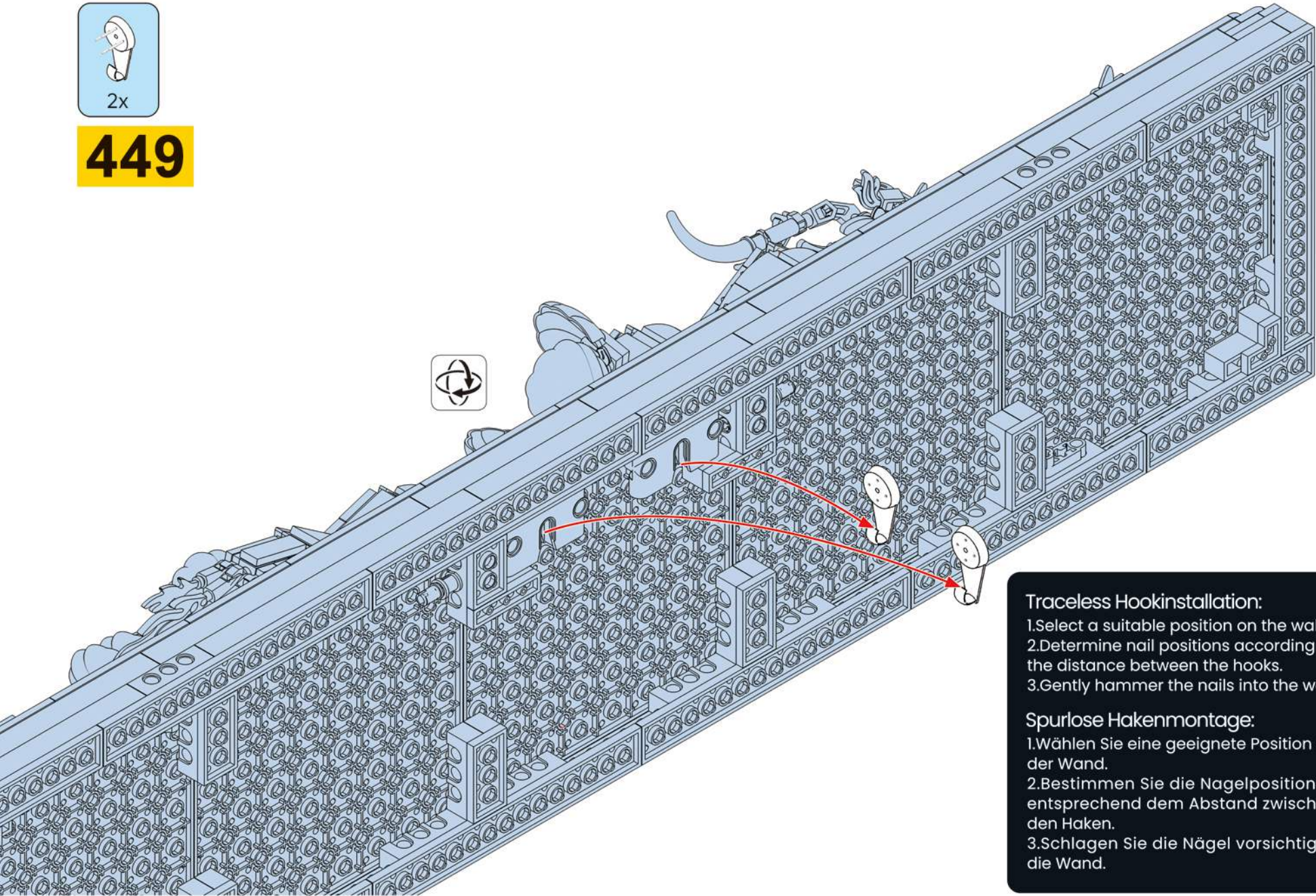

**Traceless Hookinstallation:**

1. Select a suitable position on the wall.
2. Determine nail positions according to the distance between the hooks.
3. Gently hammer the nails into the wall.

**Spurlose Hakenmontage:**

1. Wählen Sie eine geeignete Position an der Wand.
2. Bestimmen Sie die Nagelpositionen entsprechend dem Abstand zwischen den Haken.
3. Schlagen Sie die Nägel vorsichtig in die Wand.

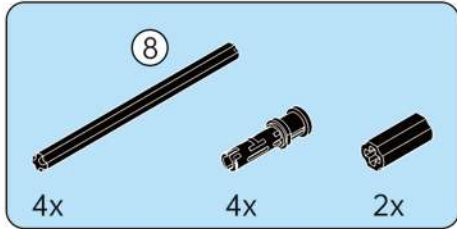

450

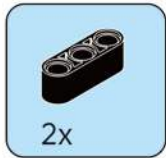
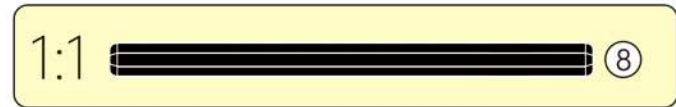
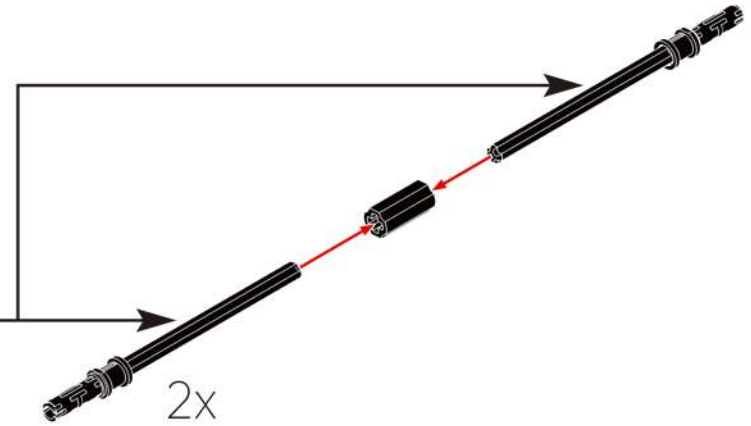
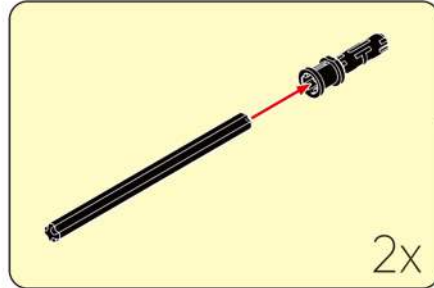

451

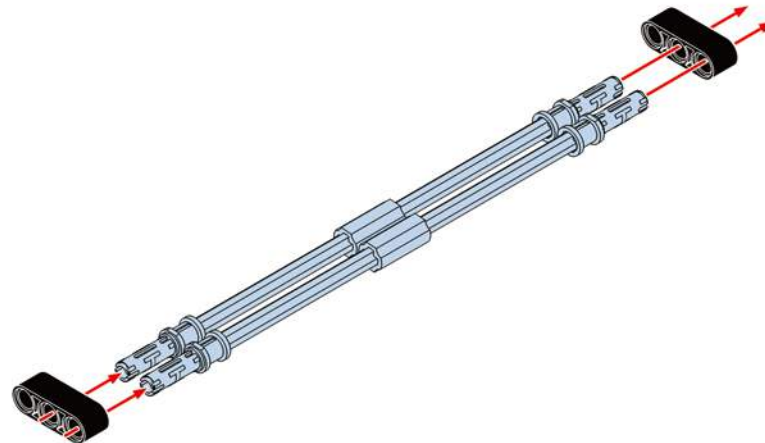

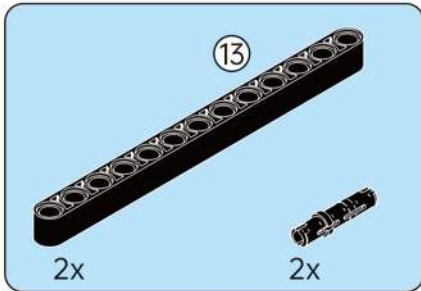

452

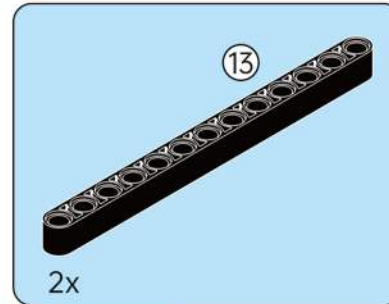
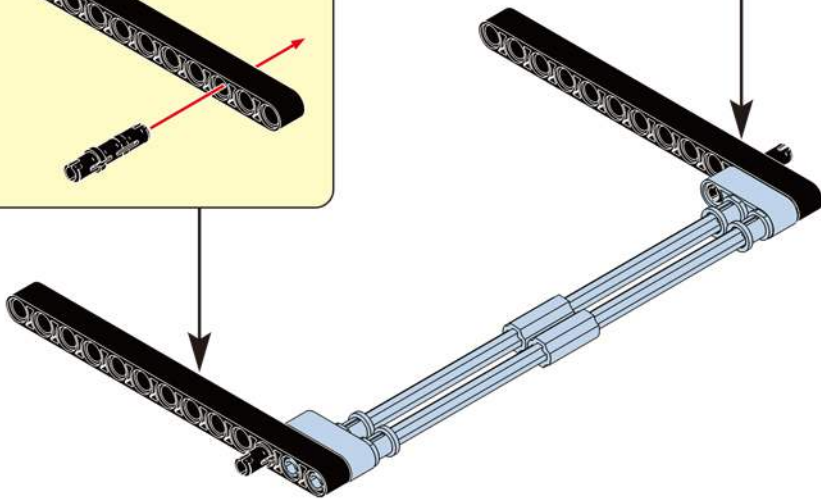
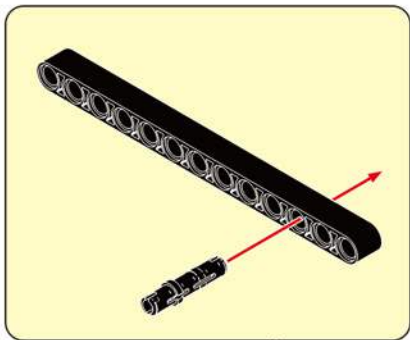
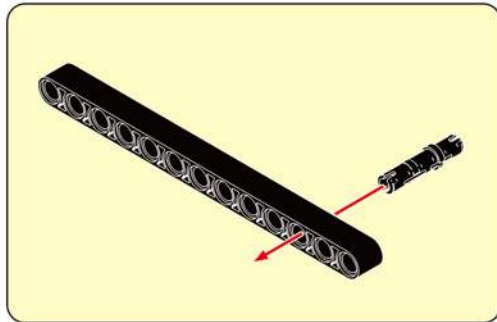

453

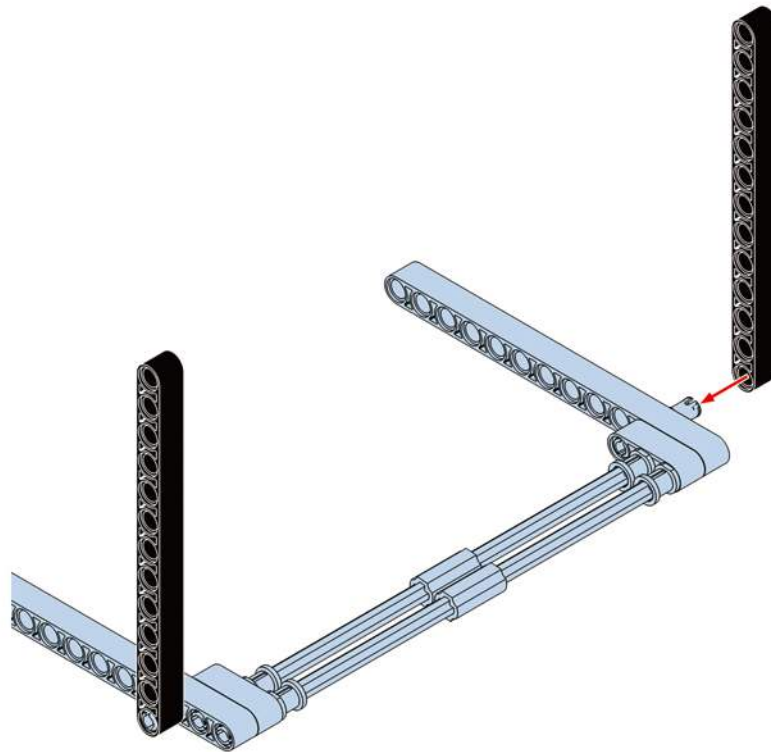

# 454

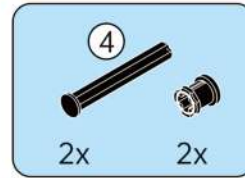
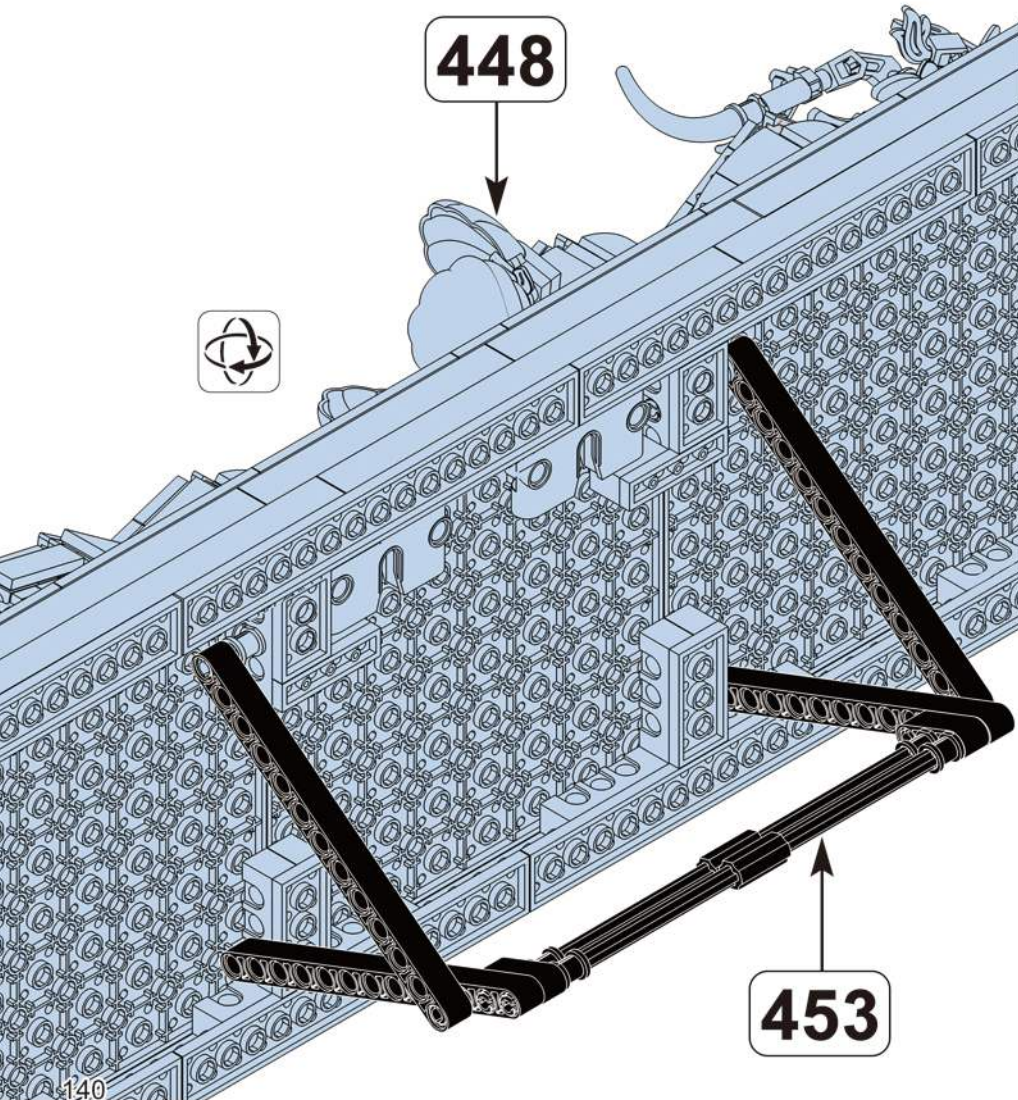

# 455

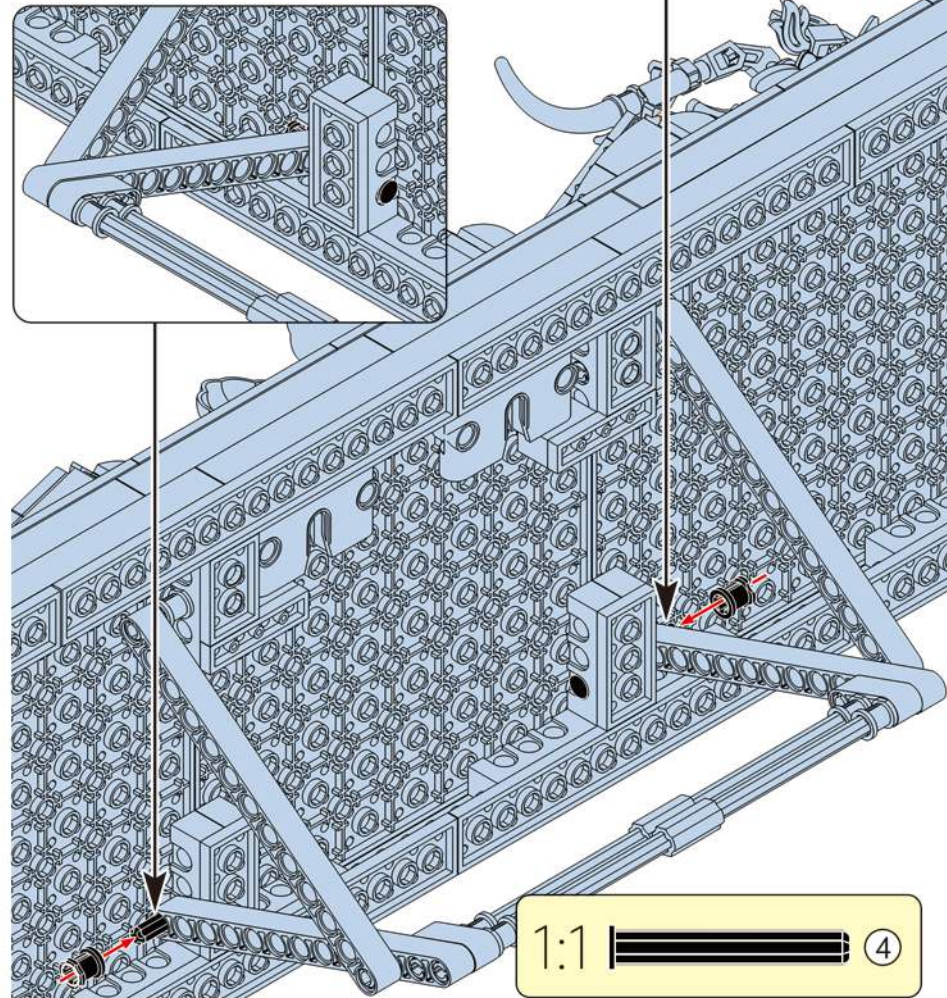
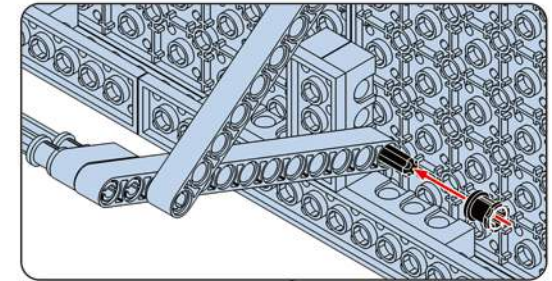

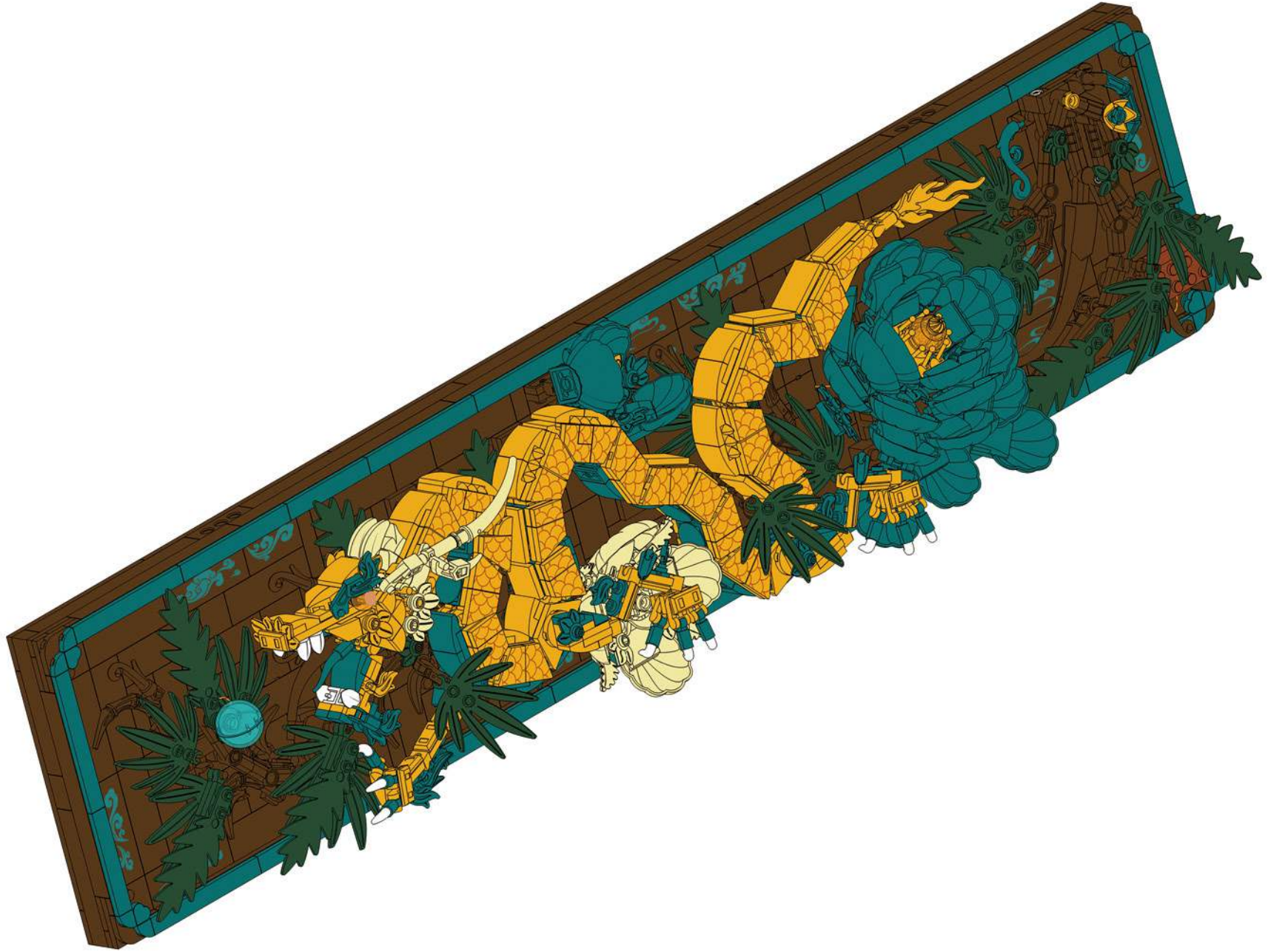



### Lighting function display :

- ON** Constant Light Mode: In this mode, the lights remain continuously illuminated once turned on, providing steady illumination until manually switched off.
- ☀** Light Sensor Mode: This setting activates the light only when ambient lighting is low, automatically turning on during nighttime or in dark conditions and switching off in bright environments, effectively saving power.
- OFF** Power Off: Selecting this option completely disables the device, ensuring no power consumption occurs until manually reactivated by the user.

These three primary functions allow versatile usage scenarios, catering to different needs whether requiring constant illumination, energy-saving automatic operation, or complete shutdown.

**Note:** When in use, Voltage must be less than 5v. Not for children under eight.

### Beleuchtungsfunktionen:

- ON** Ständige Beleuchtungsmodus: Sobald eingeschaltet, bleiben die Lichter kontinuierlich erleuchtet und bieten eine stabile Beleuchtung bis manuell ausgeschaltet.
- ☀** Lichtsensor Modus: Diese Einstellung aktiviert das Licht nur bei schwacher Umgebungsbewegung, schaltet es automatisch in der Nacht oder in dunklen Bedingungen ein und in hellen Umgebungen aus, was effektiv Strom spart.
- OFF** Ausschalten: Die Auswahl dieser Option deaktiviert das Gerät vollständig, wodurch kein Stromverbrauch auftritt, bis durch den Benutzer manuell erneut aktiviert.

Diese drei Hauptfunktionen ermöglichen vielseitige Szenarien, die unterschiedliche Anforderungen abdecken, sei es konstante Beleuchtung, energieeffiziente automatische Betrieb oder vollständiges Ausschalten.

**Hinweis:** Beim Einsatz muss die Spannung kleiner als 5V sein. Nicht für Kinder unter acht Jahren geeignet.



# A

# 2 IN 1

This series of products can be assembled in a two-in-one combination. You can freely combine them by yourself. The following steps mainly demonstrate the combined assembly of NO.70019 and NO.70020.

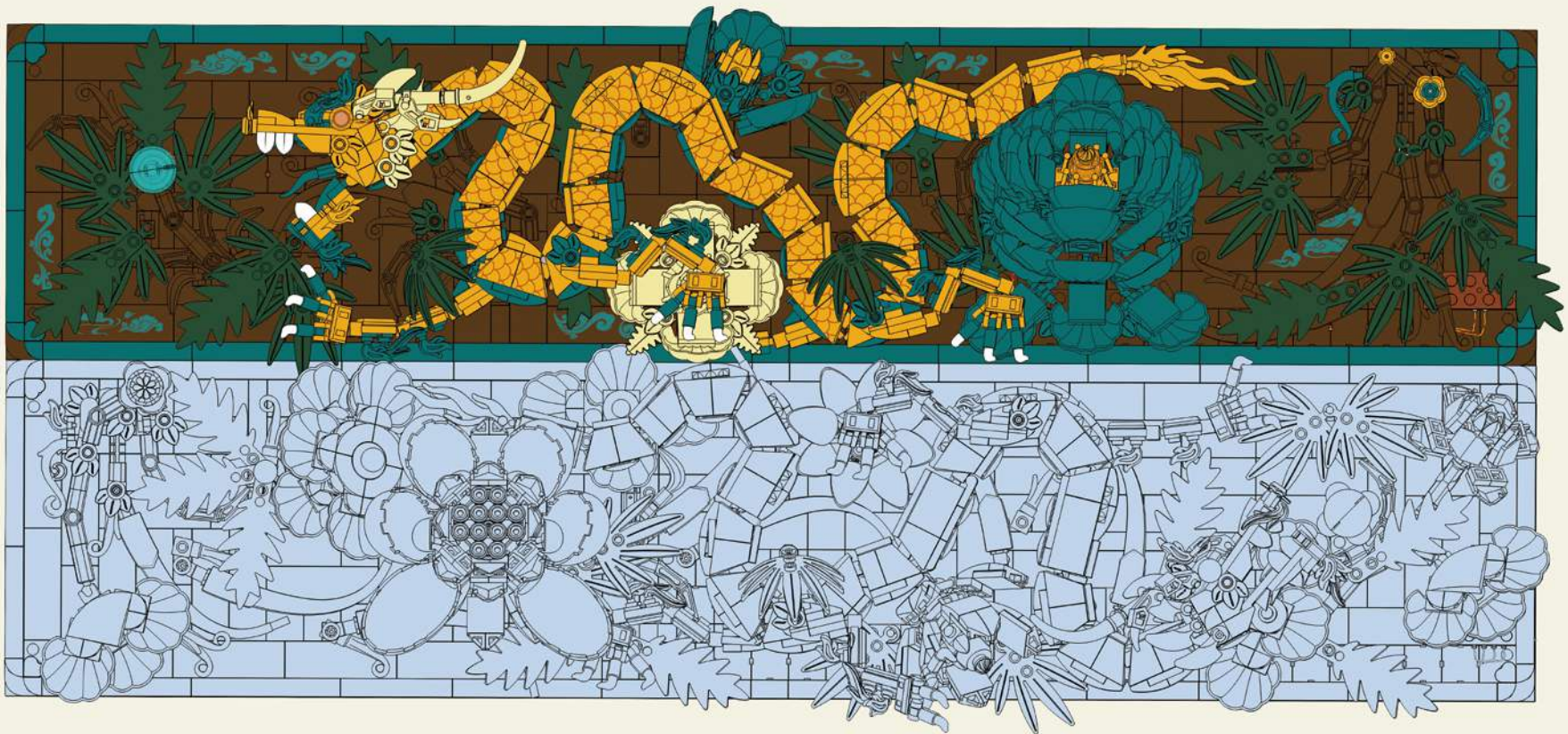

8  
4x 4x 2x

**A1**

2x

448

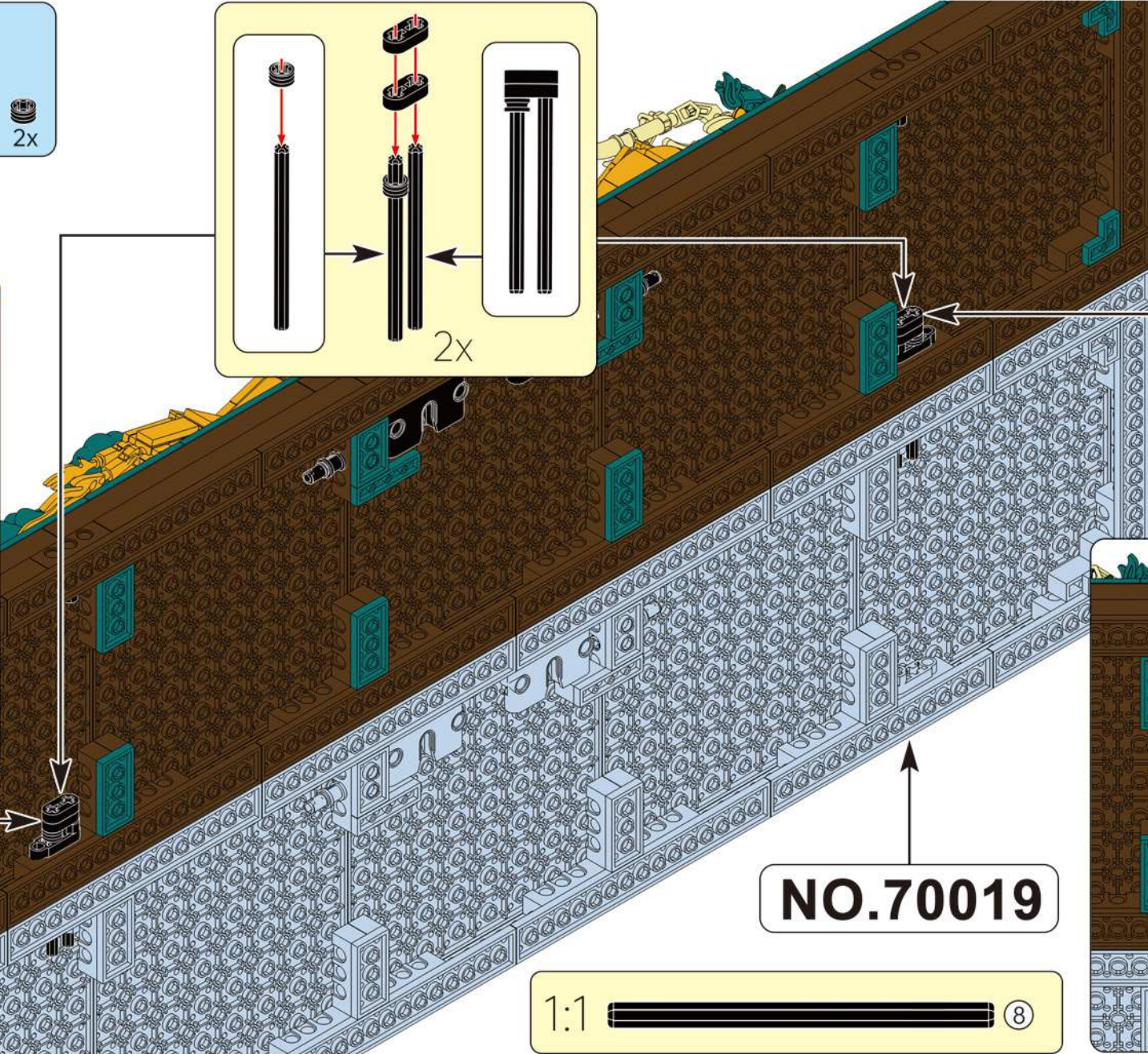
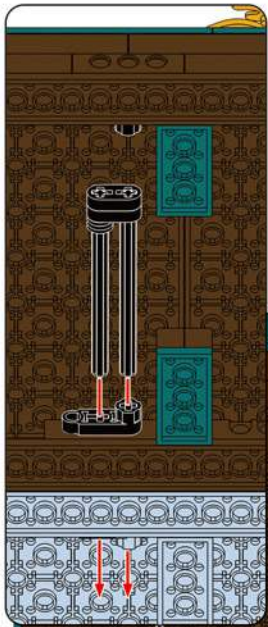

**NO.70019**

1:1 8

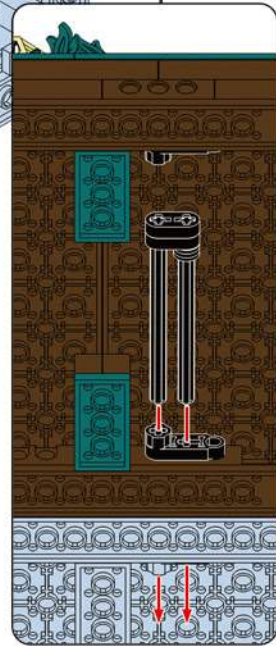

4x    2x

# A2

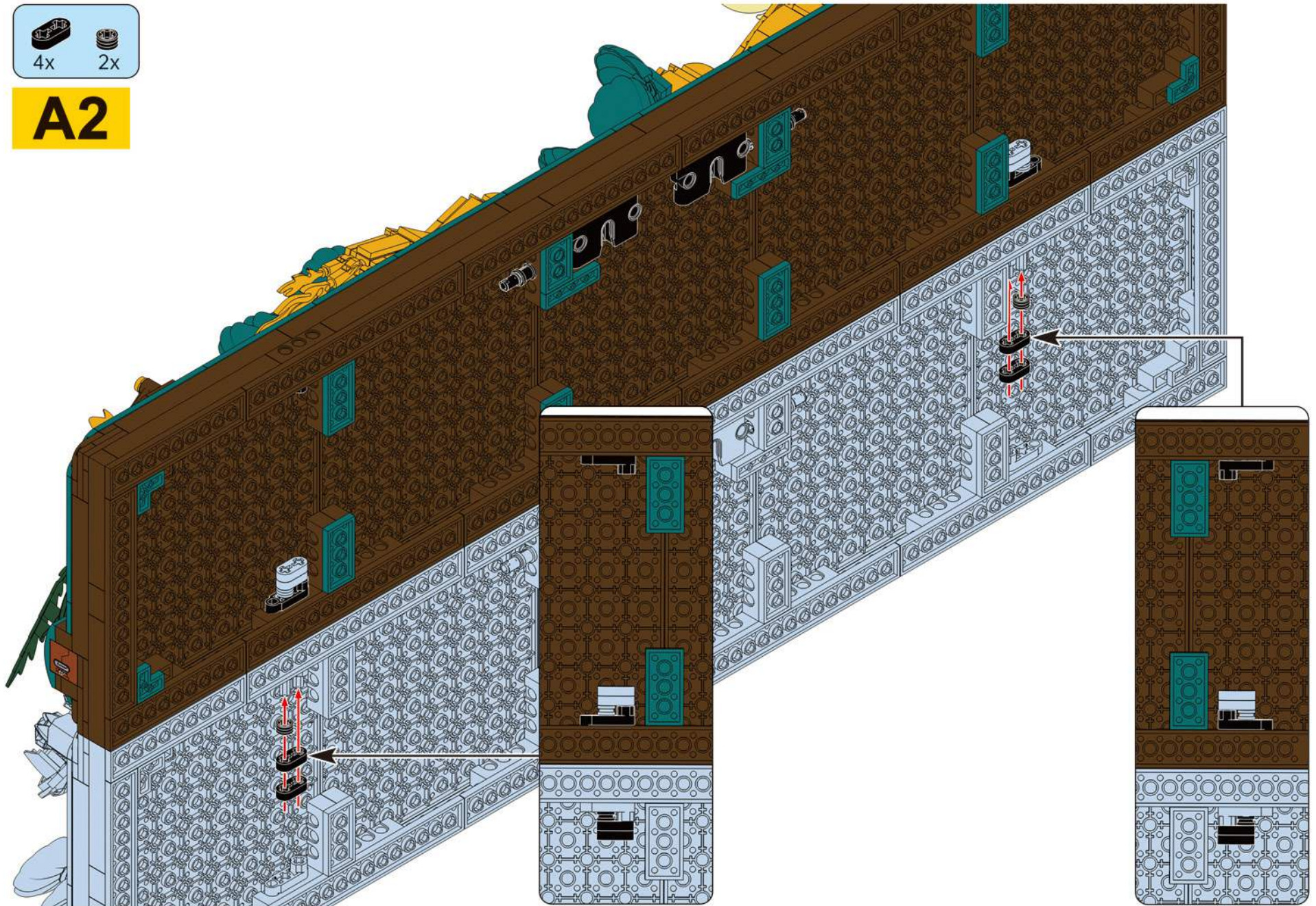

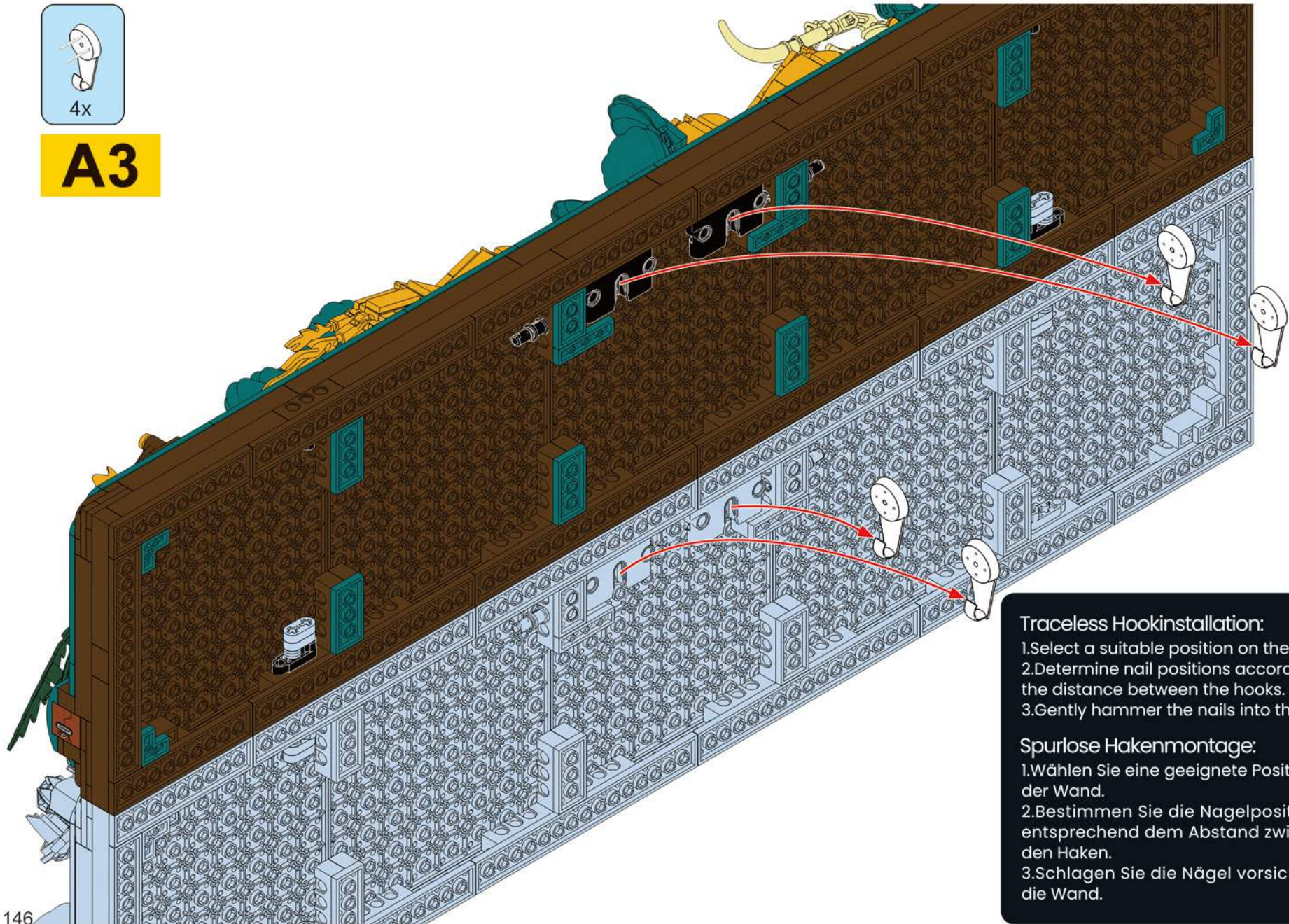
**A3****Traceless Hookinstallation:**

1. Select a suitable position on the wall.
2. Determine nail positions according to the distance between the hooks.
3. Gently hammer the nails into the wall.

**Spurlose Hakenmontage:**

1. Wählen Sie eine geeignete Position an der Wand.
2. Bestimmen Sie die Nagelpositionen entsprechend dem Abstand zwischen den Haken.
3. Schlagen Sie die Nägel vorsichtig in die Wand.

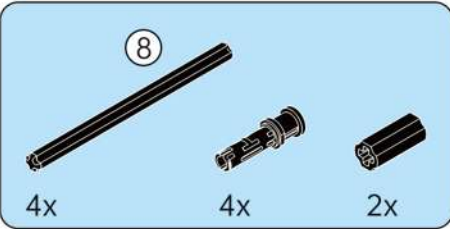

**A4**

To carry out this part of the assembly, the previously assembled brackets need to be disassembled.

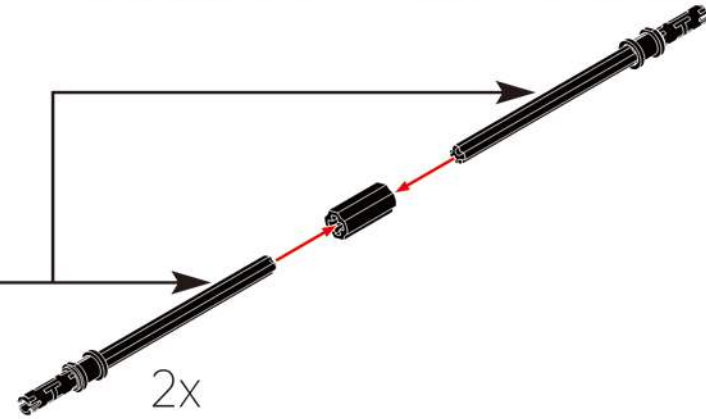
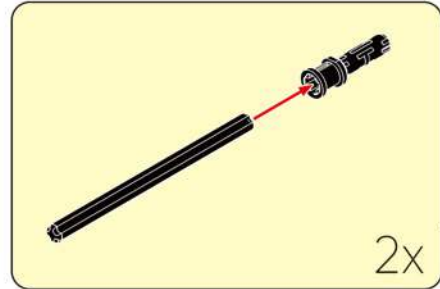

**A5**

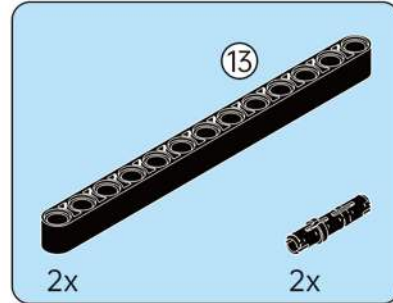
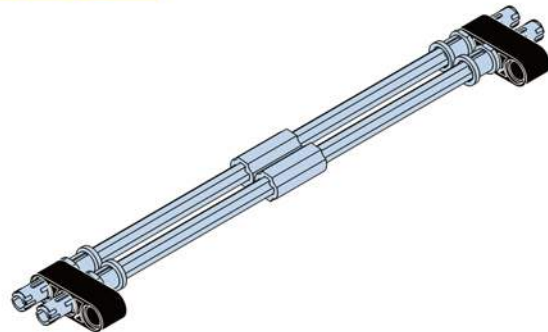

**A6**

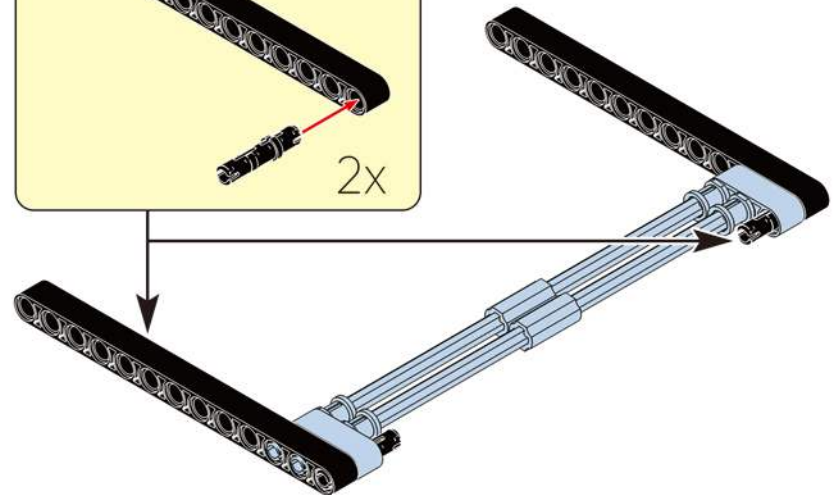
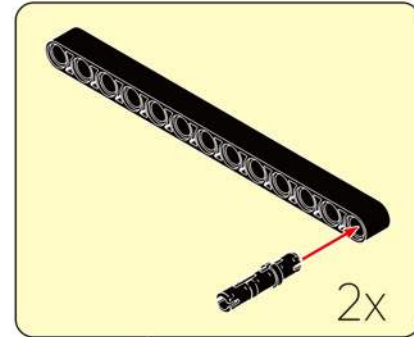

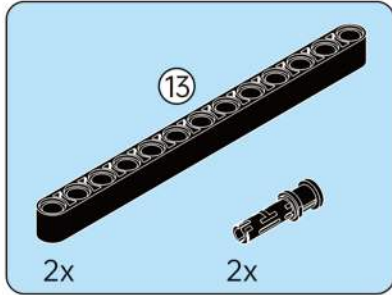

**A7**

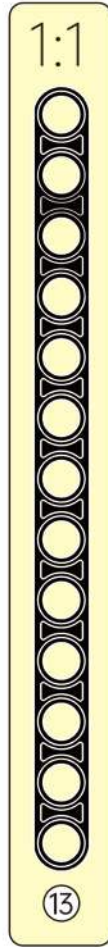
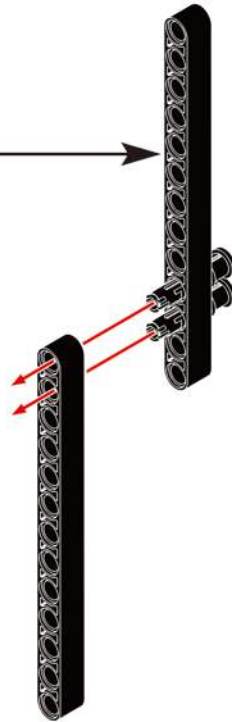
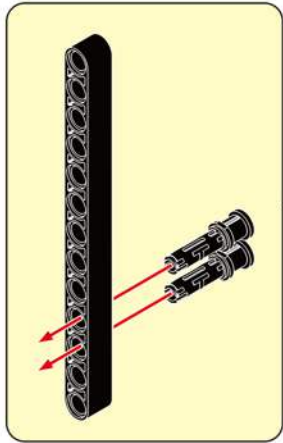

**A8**

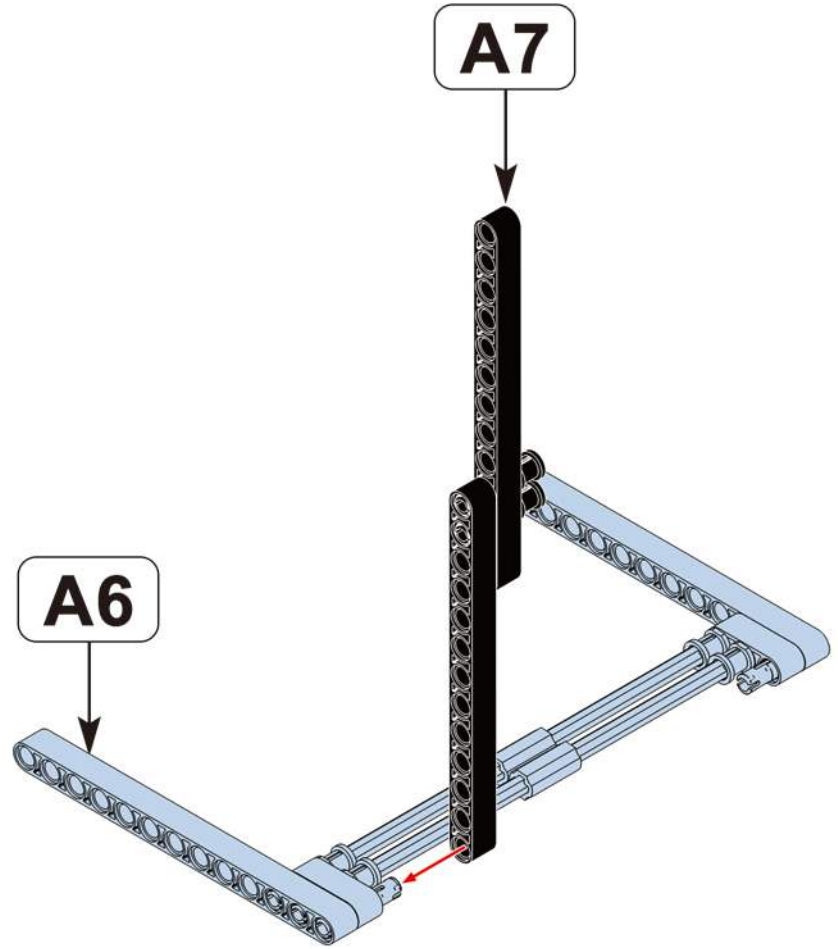

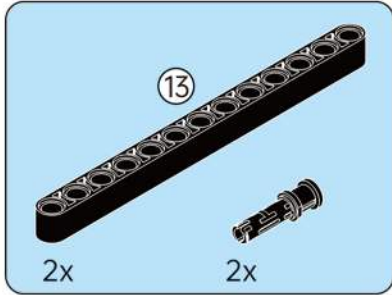

**A9**

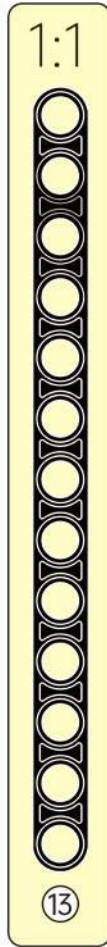
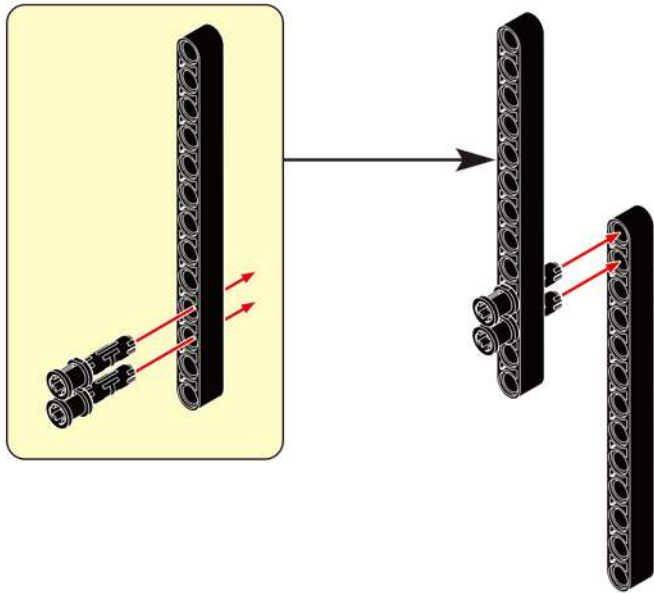

**A10**

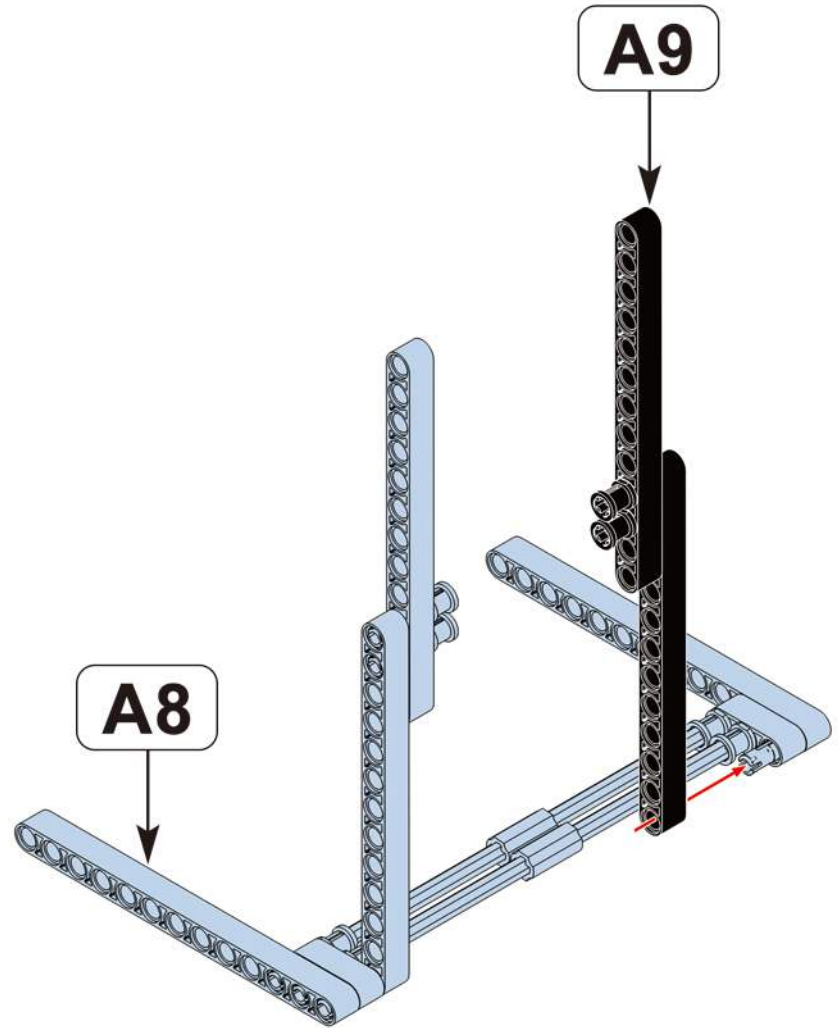

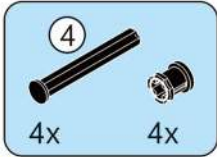

**A11**

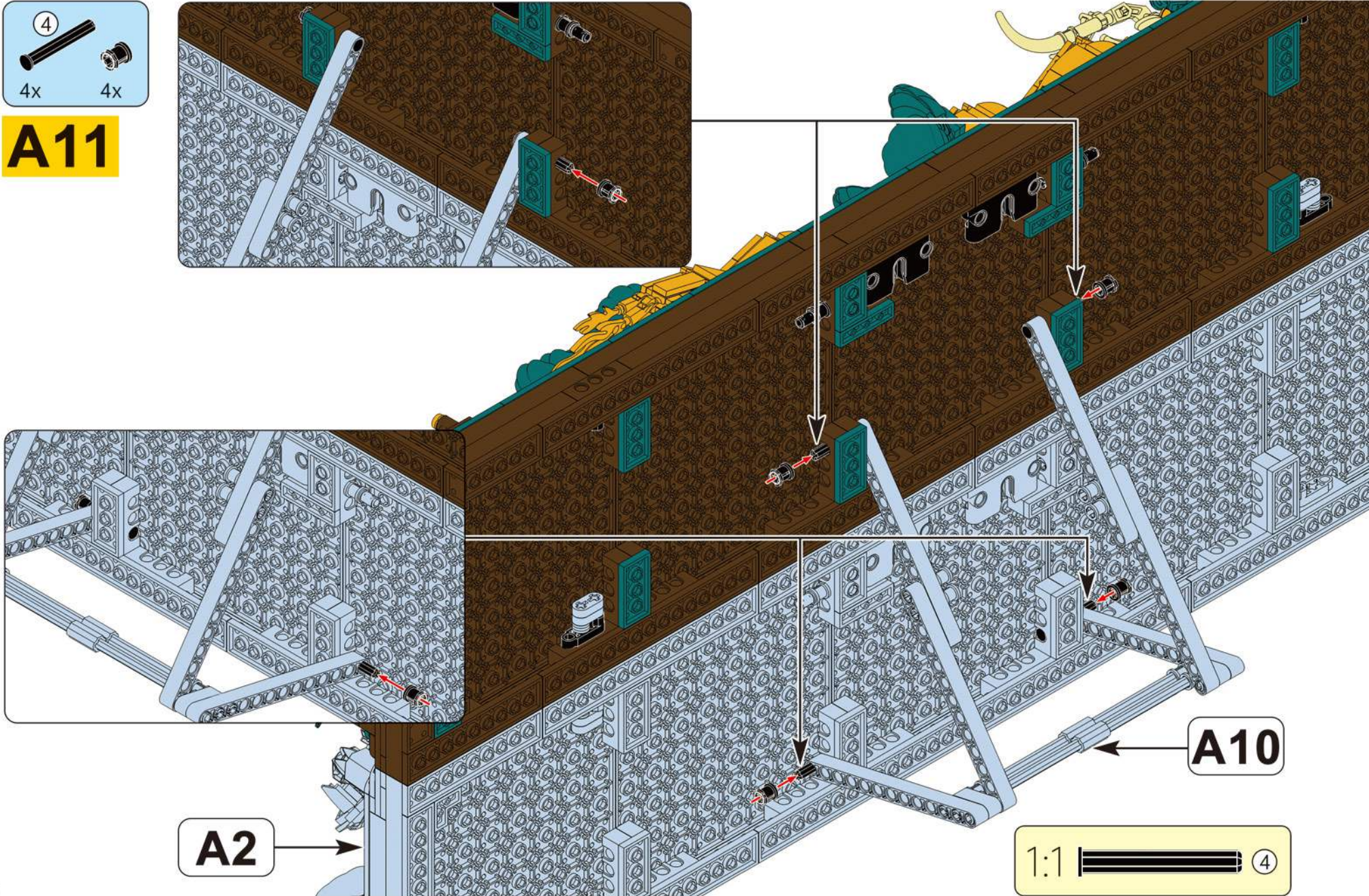

**B**

**3 IN 1**

This series of products can be assembled in a three in one combination. You can freely combine them by yourself. The following steps mainly demonstrate the combination assembly of NO.70019, NO.70020, and NO.70021.

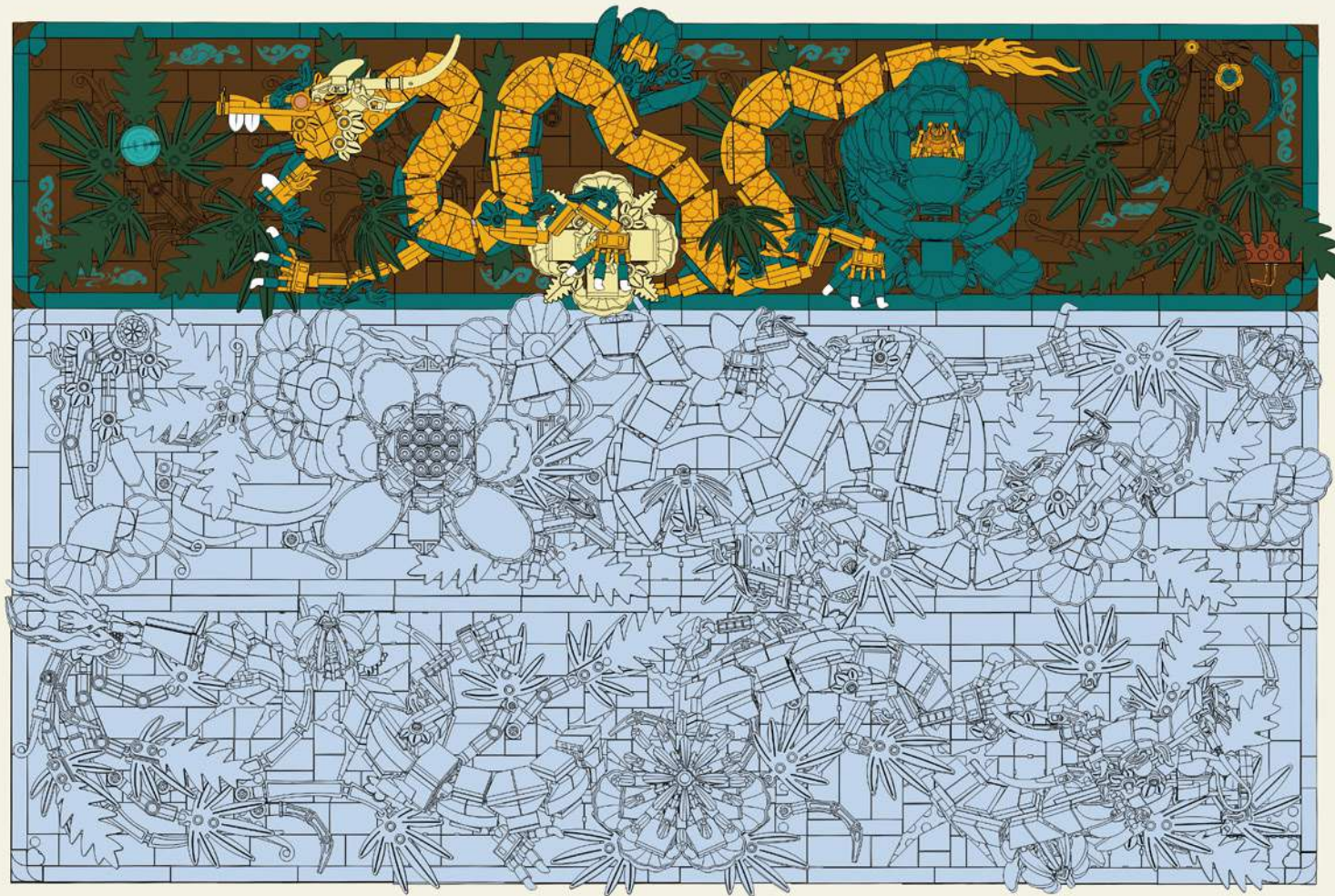

8  
4x 4x 2x

**B1**

2x

448

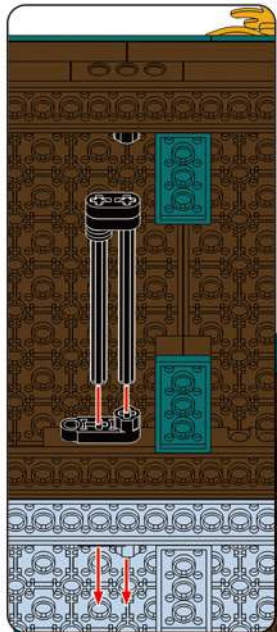

**NO.70019**

1:1 8

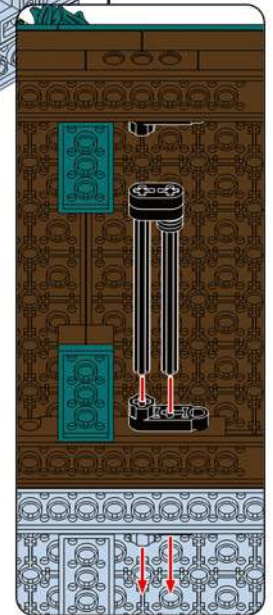

4x 2x

**B2**

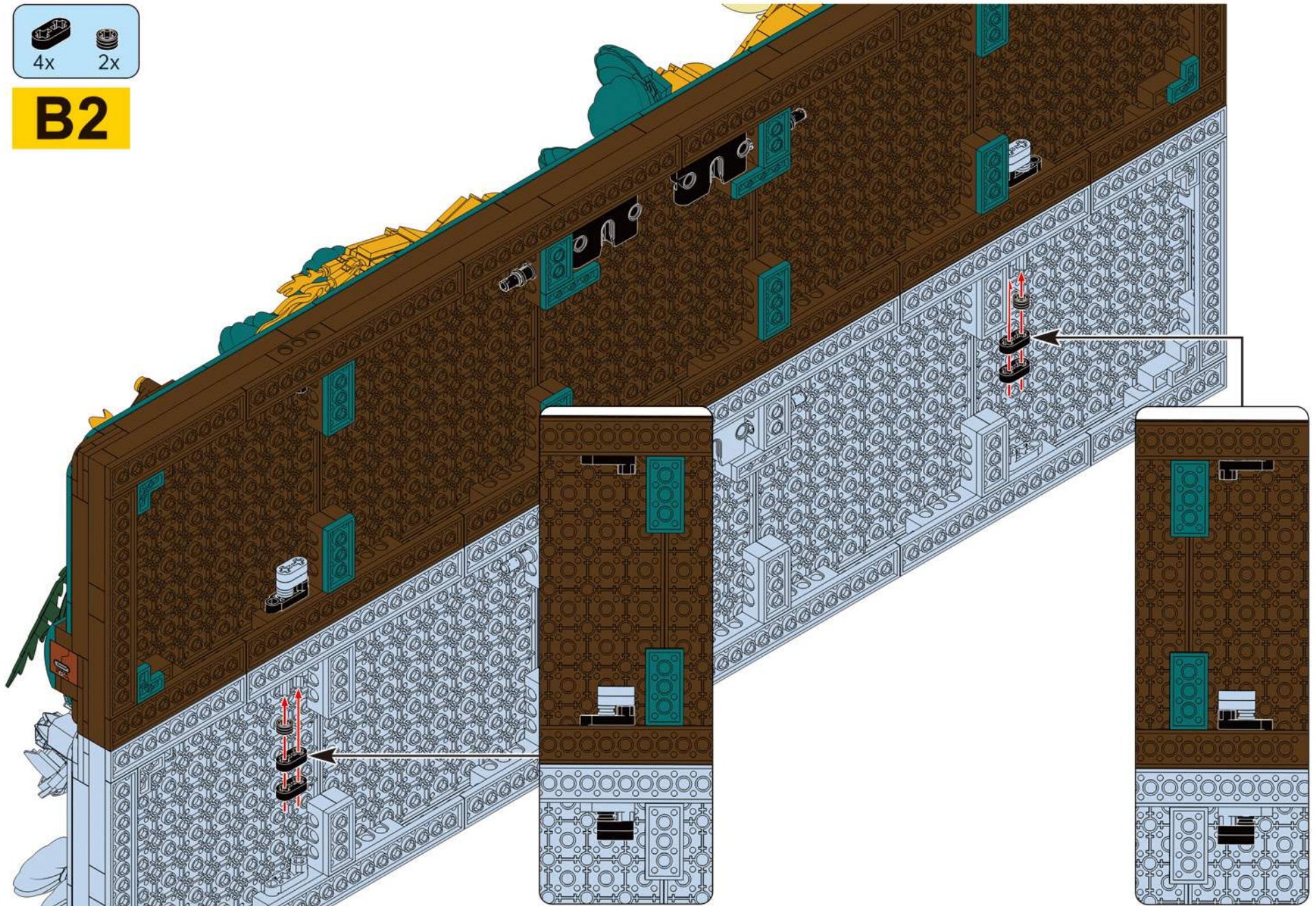

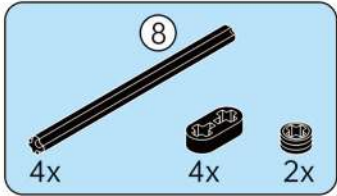

**B3**

**B2**

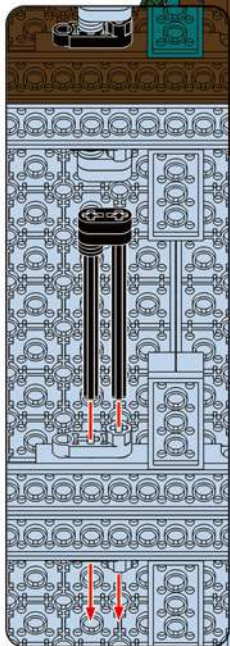
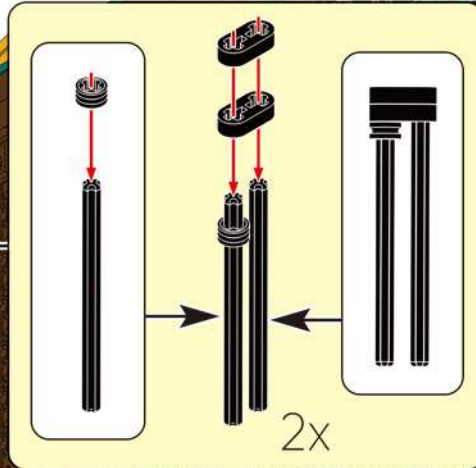

**NO.70021**

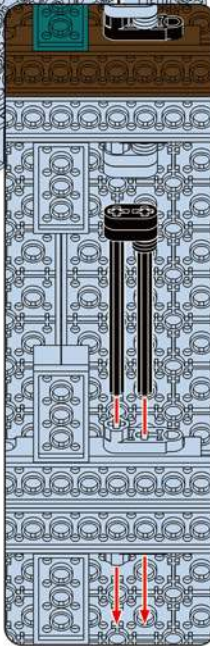

4x 2x

**B4**

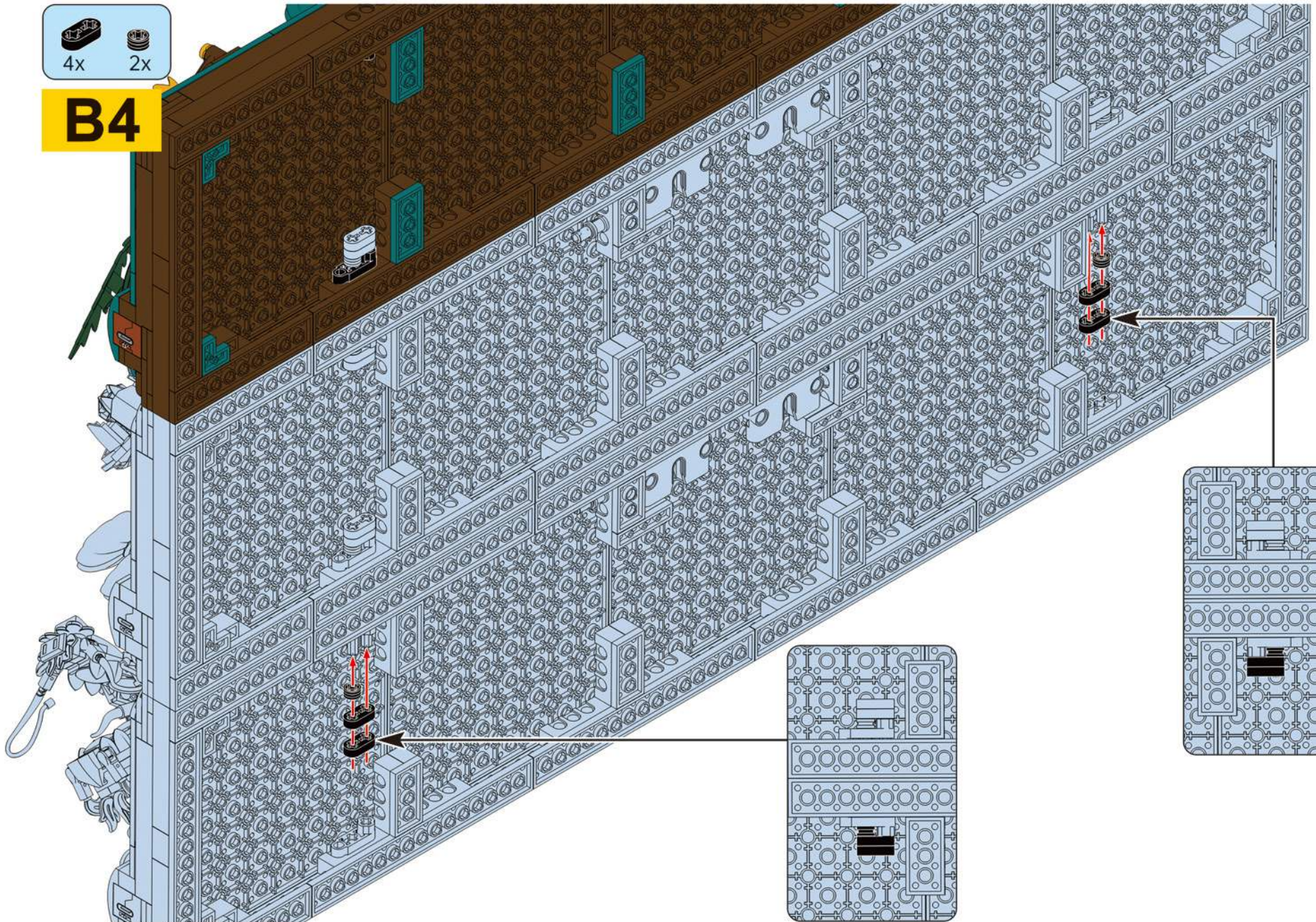

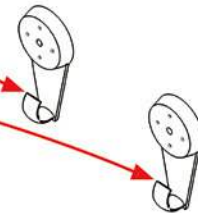
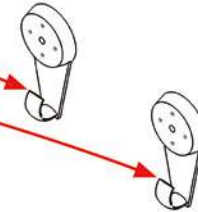
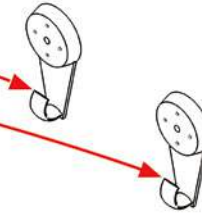
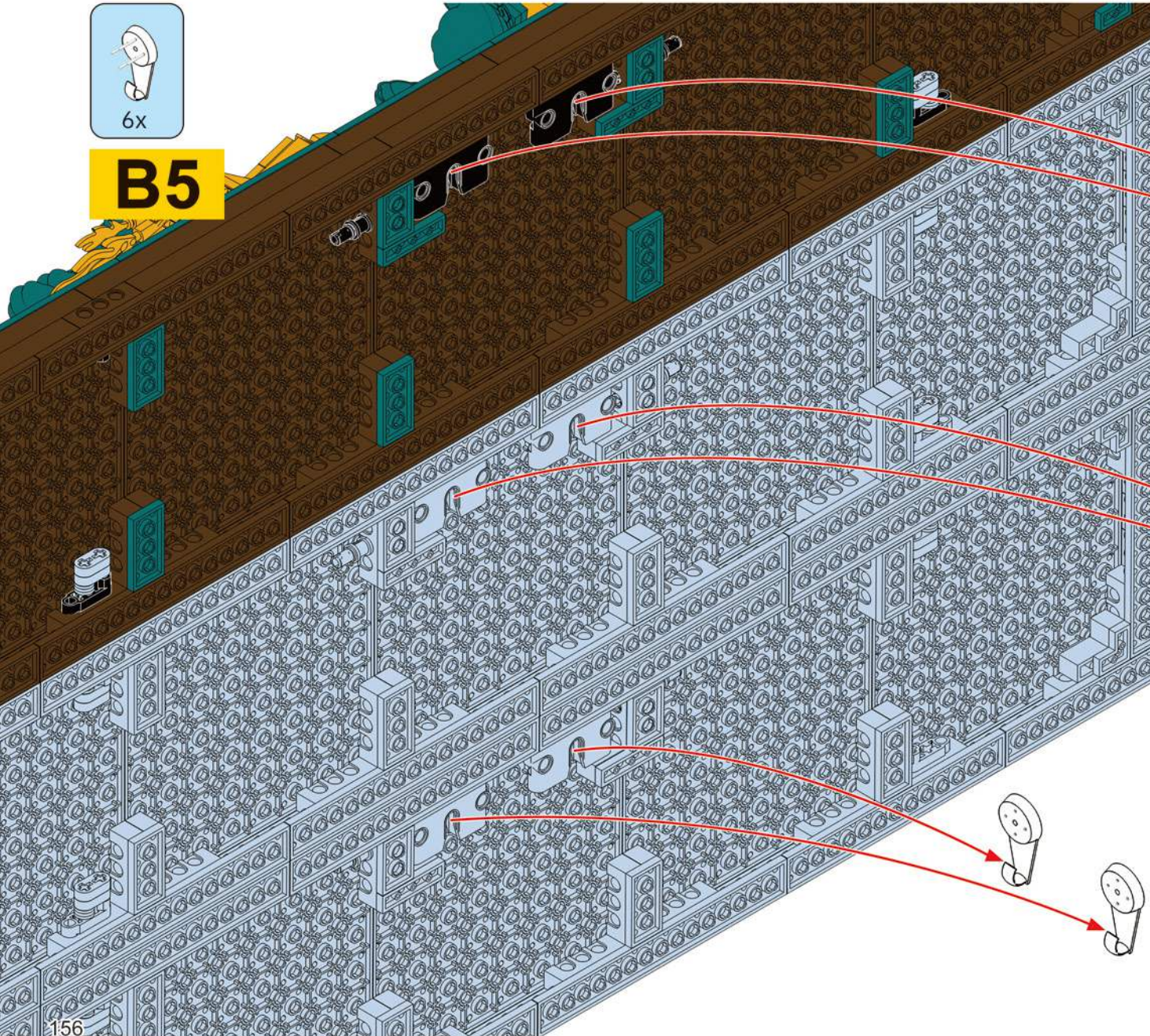

**B5**

**Traceless Hookinstallation:**

1. Select a suitable position on the wall.
2. Determine nail positions according to the distance between the hooks.
3. Gently hammer the nails into the wall.

**Spurlose Hakenmontage:**

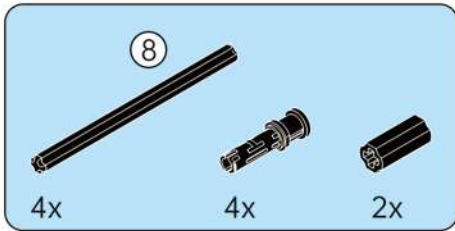
1. Wählen Sie eine geeignete Position an der Wand.
2. Bestimmen Sie die Nagelpositionen entsprechend dem Abstand zwischen den Haken.
3. Schlagen Sie die Nägel vorsichtig in die Wand.

To carry out this part of the assembly, the previously assembled brackets need to be disassembled.



# B6

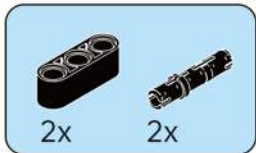
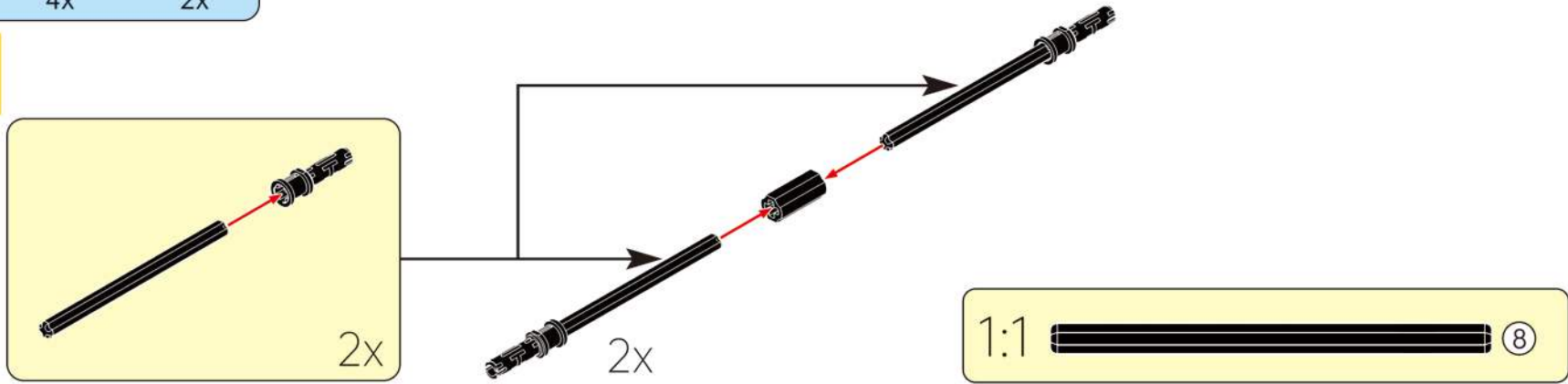

# B7

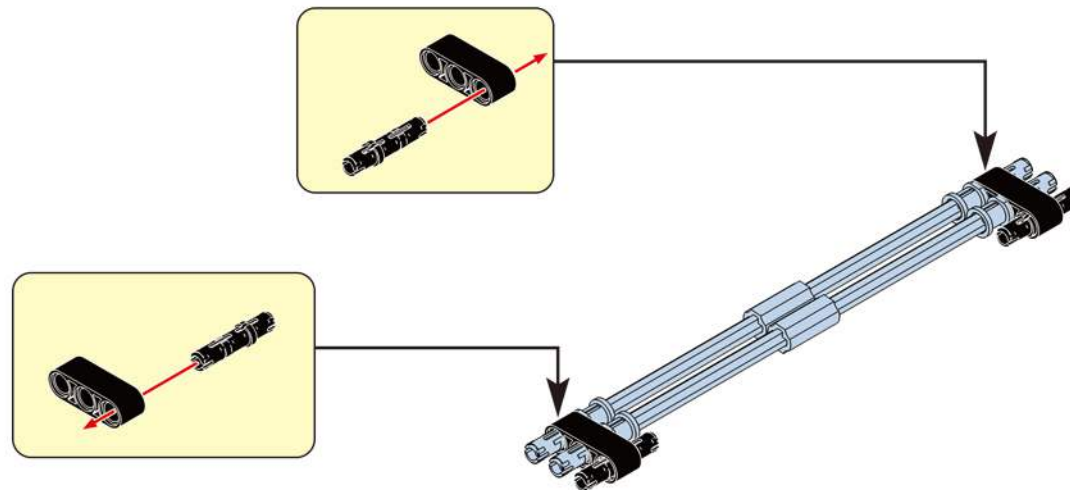

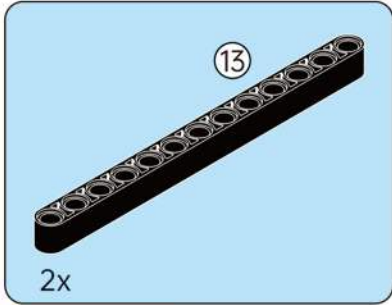

**B8**

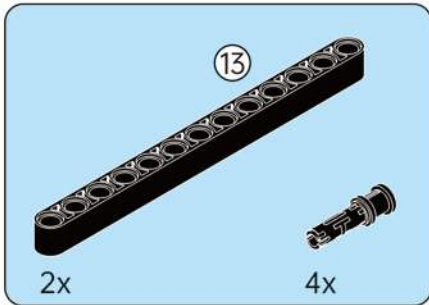
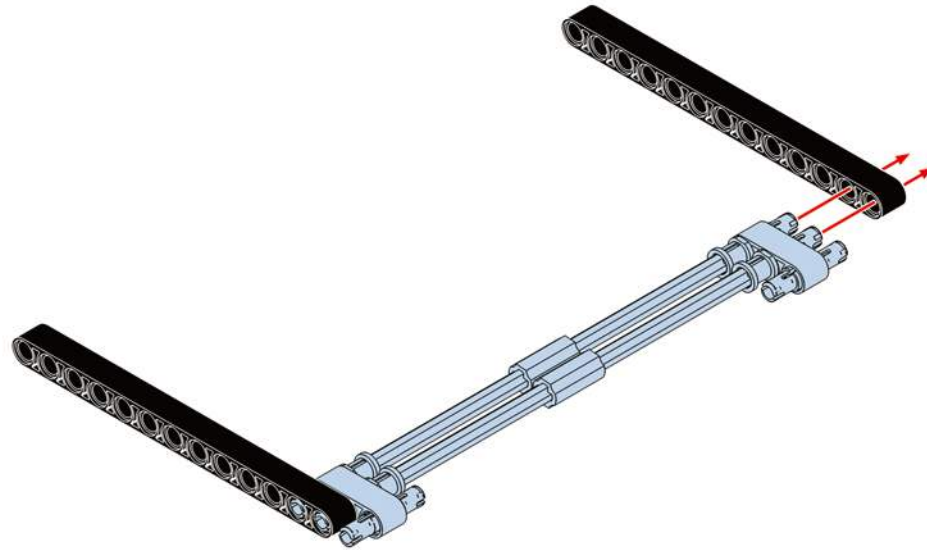

**B9**

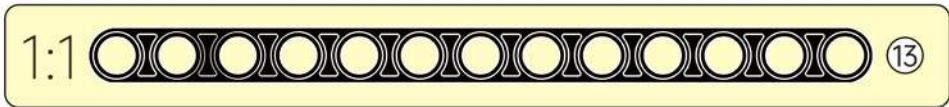
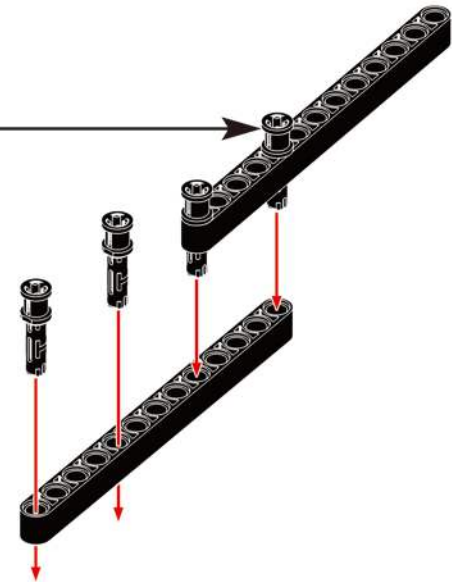
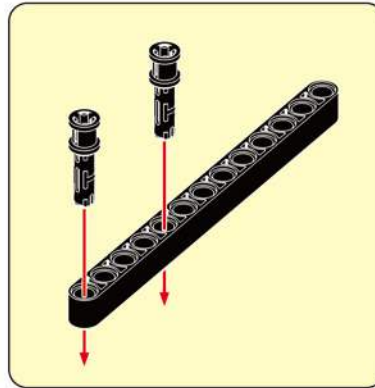

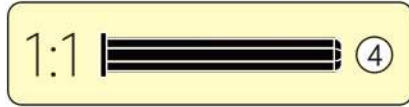
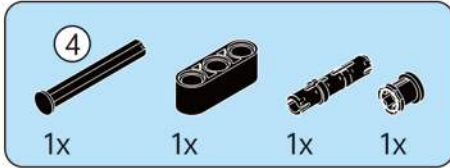

# B10

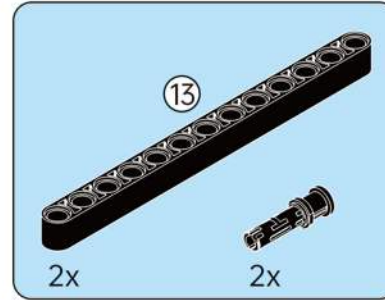
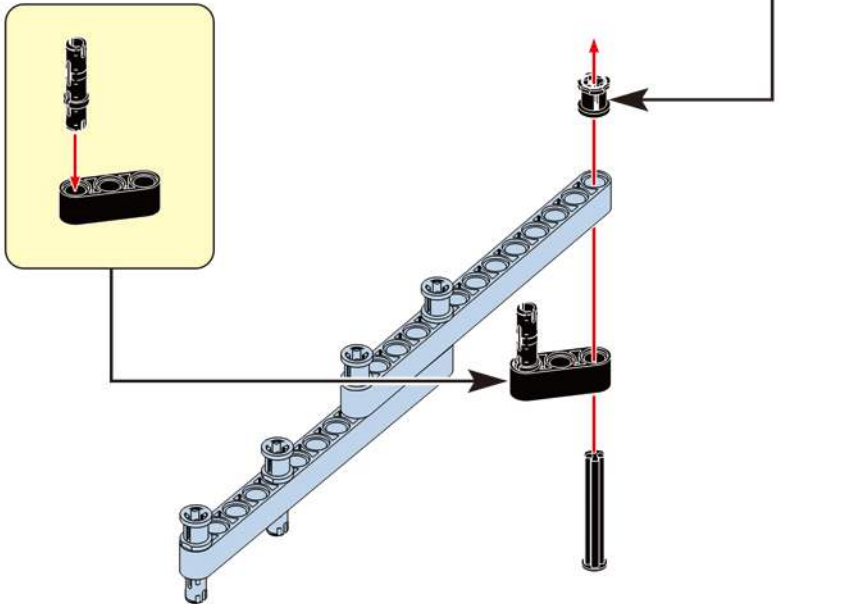
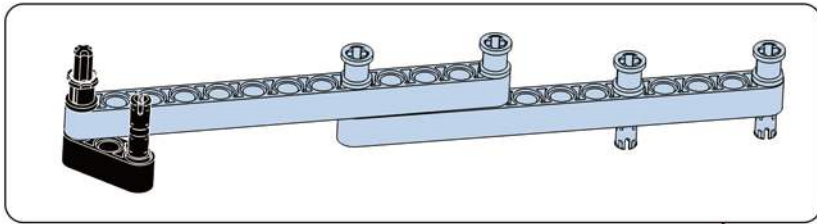

# B11

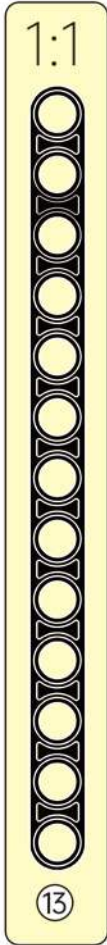
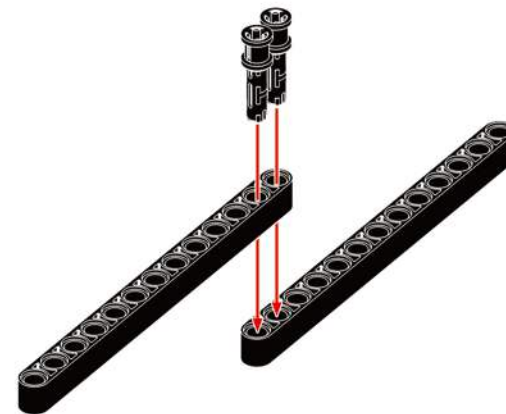

# B12

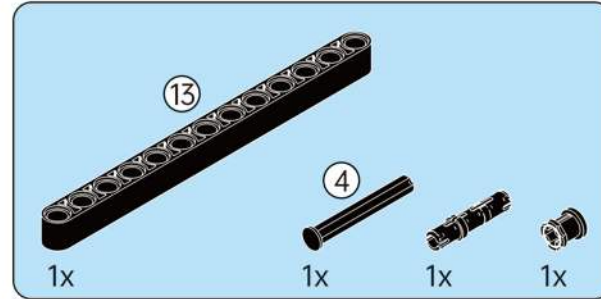
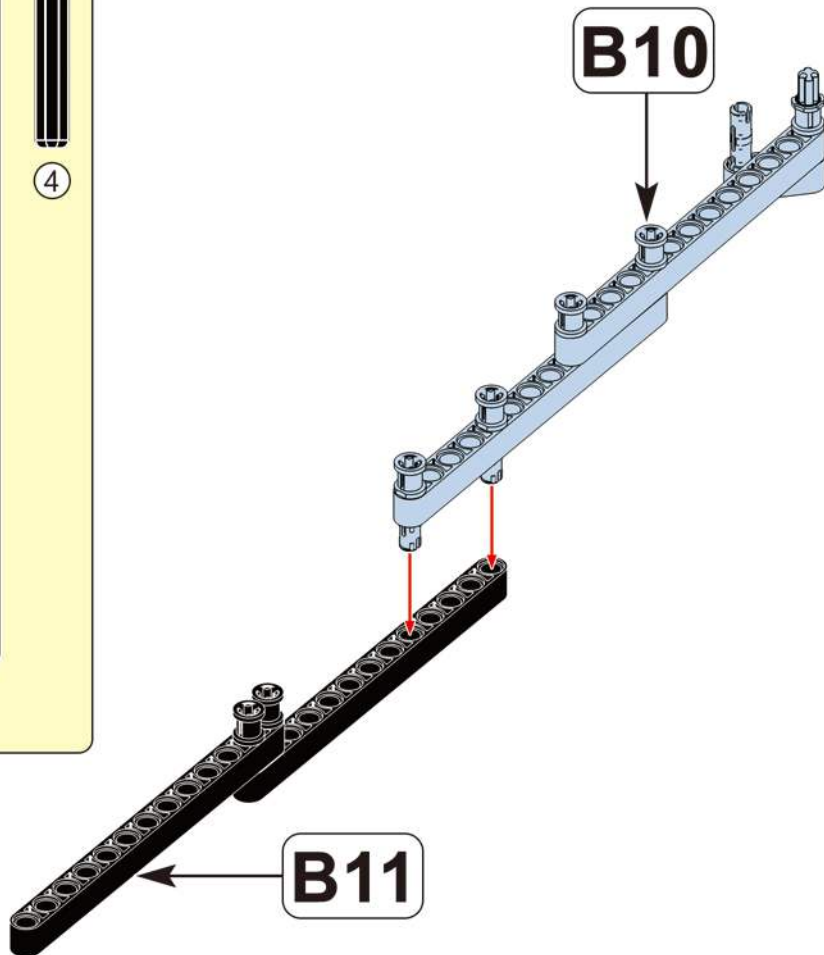
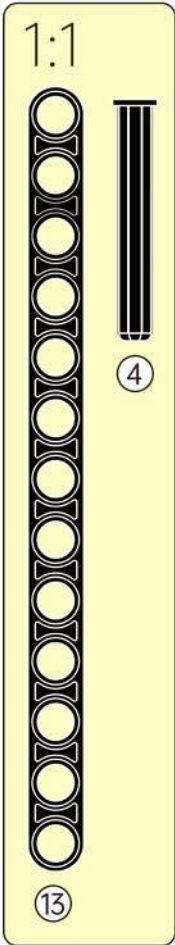

# B13

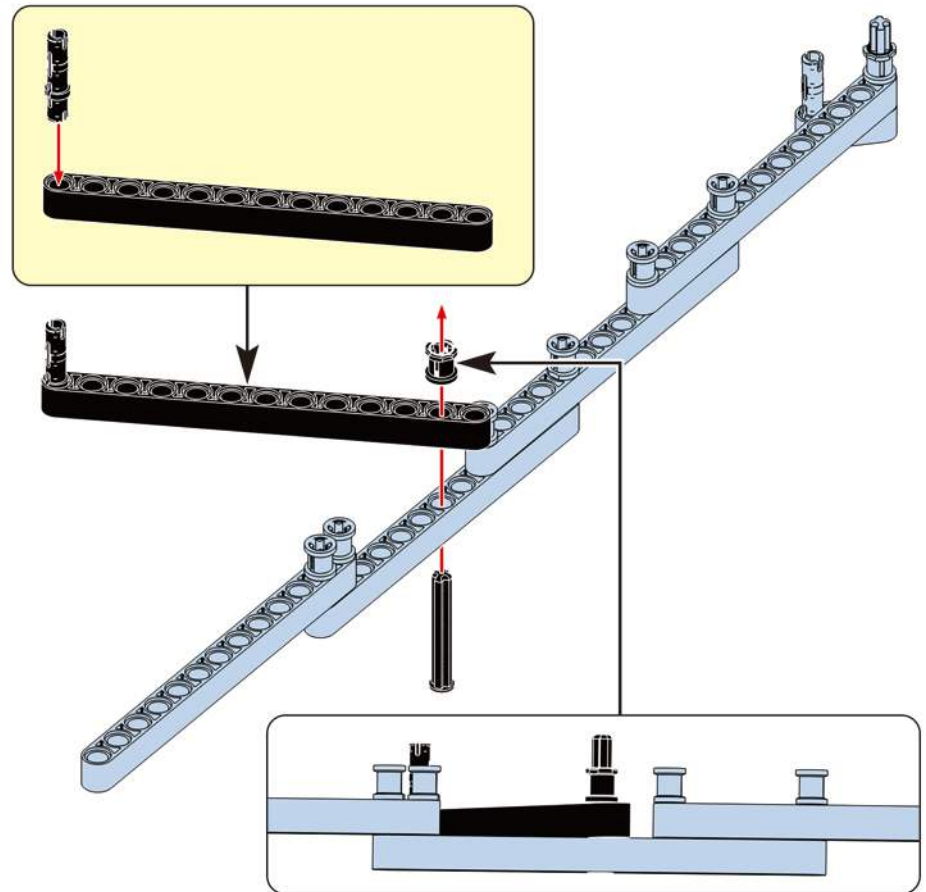

# B14

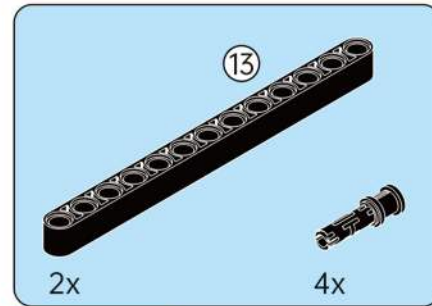
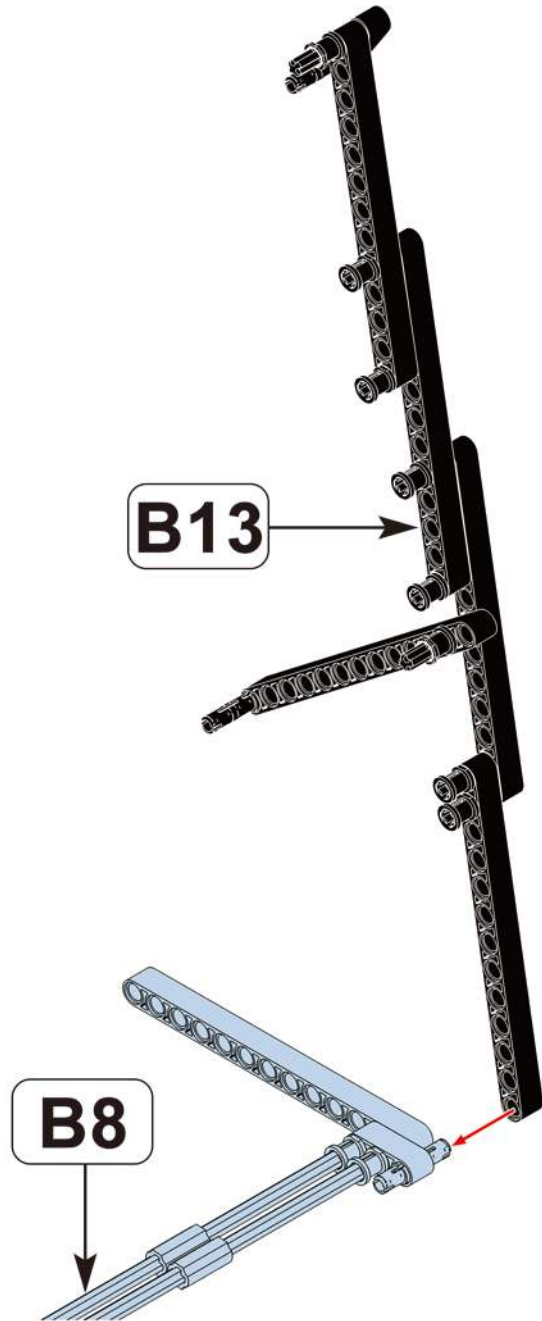

# B15

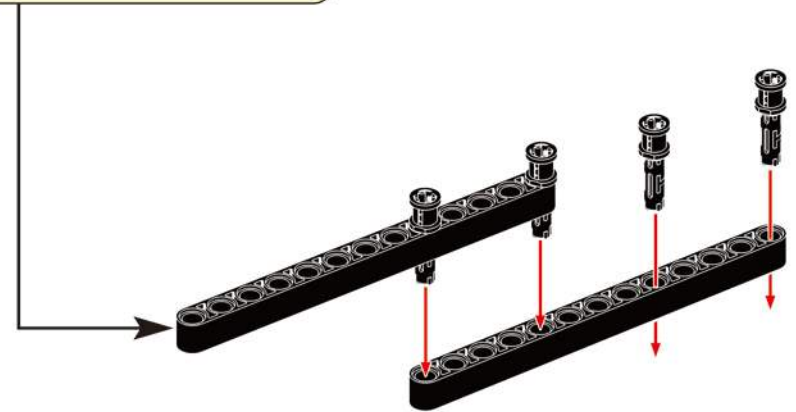
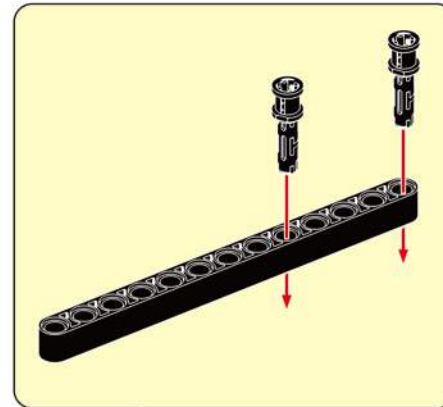

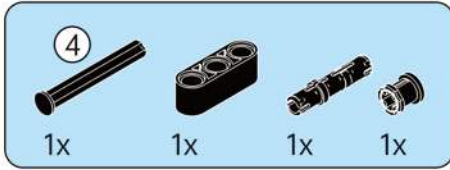

# B16

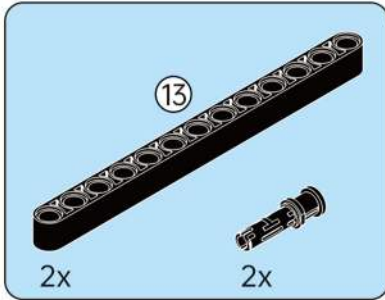
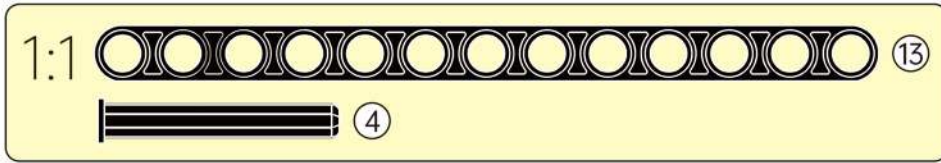
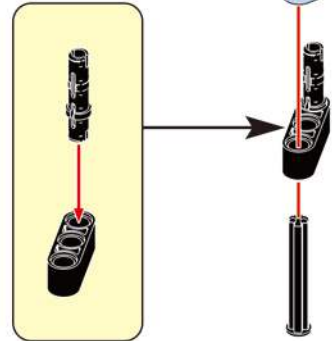
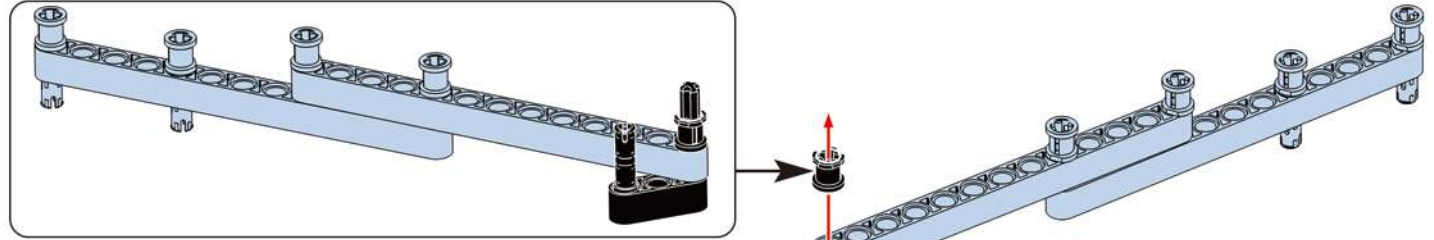

# B17

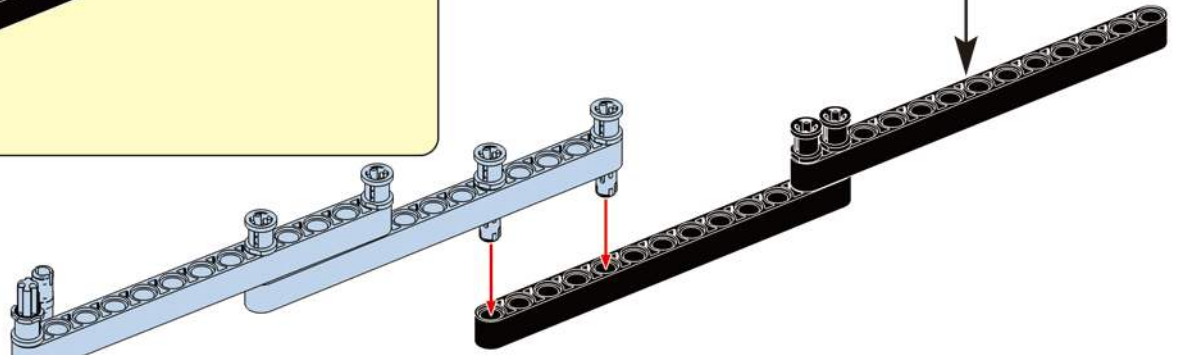
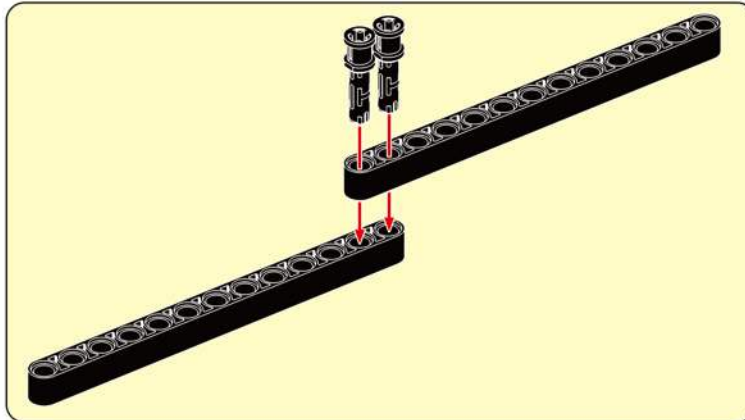

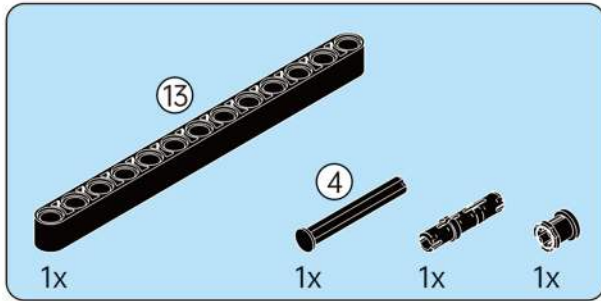

# B18

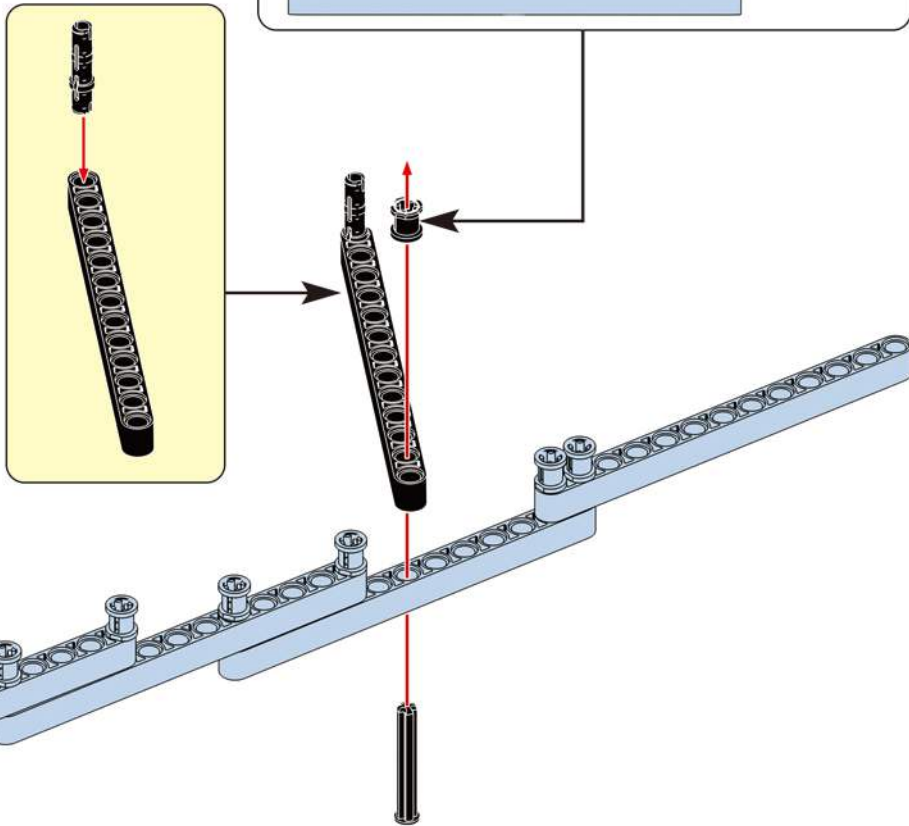

# B19

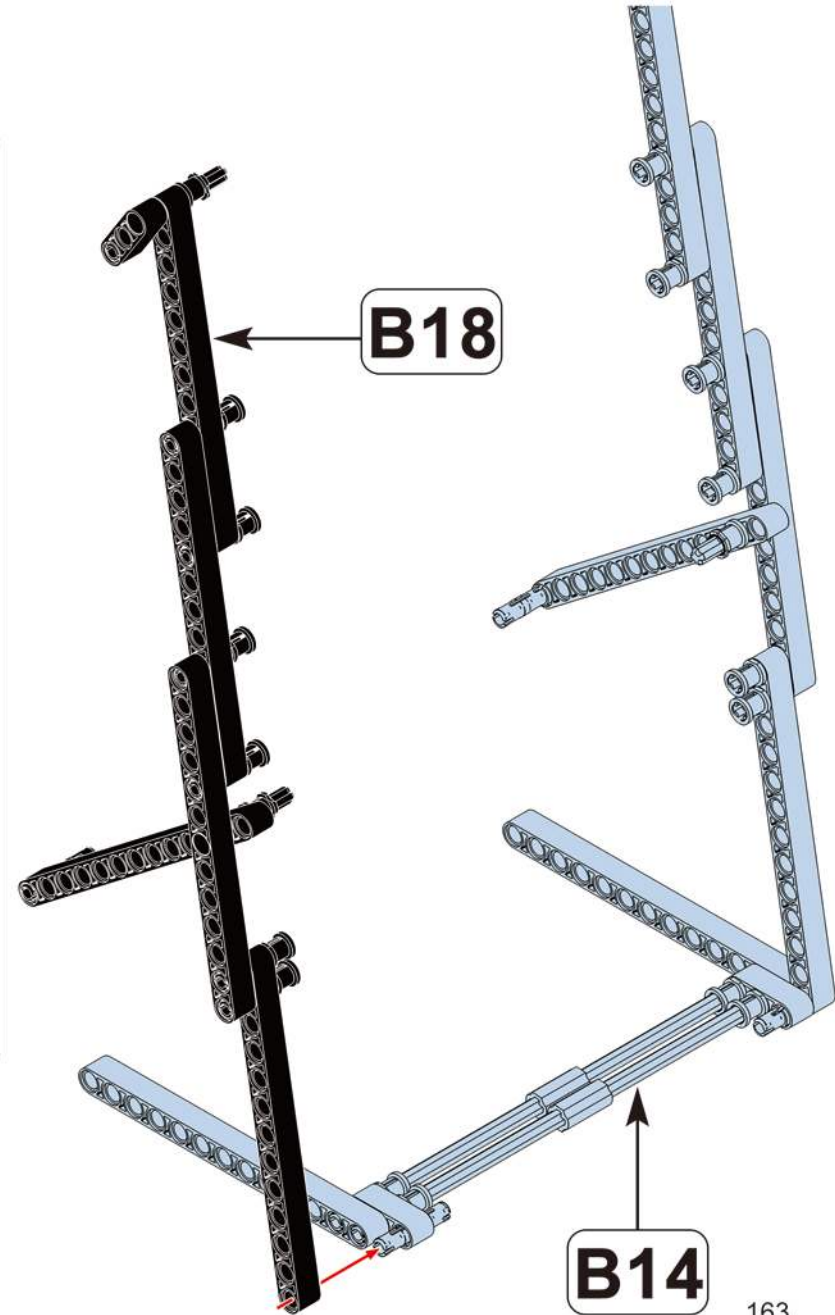
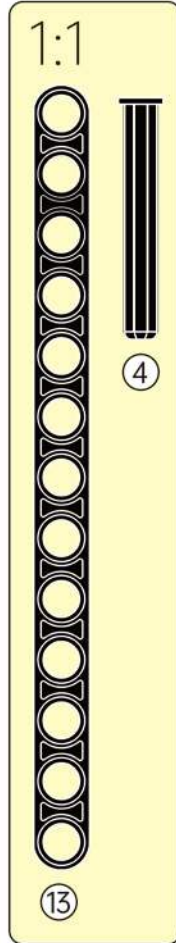

**B20**

**B4**

**B19**

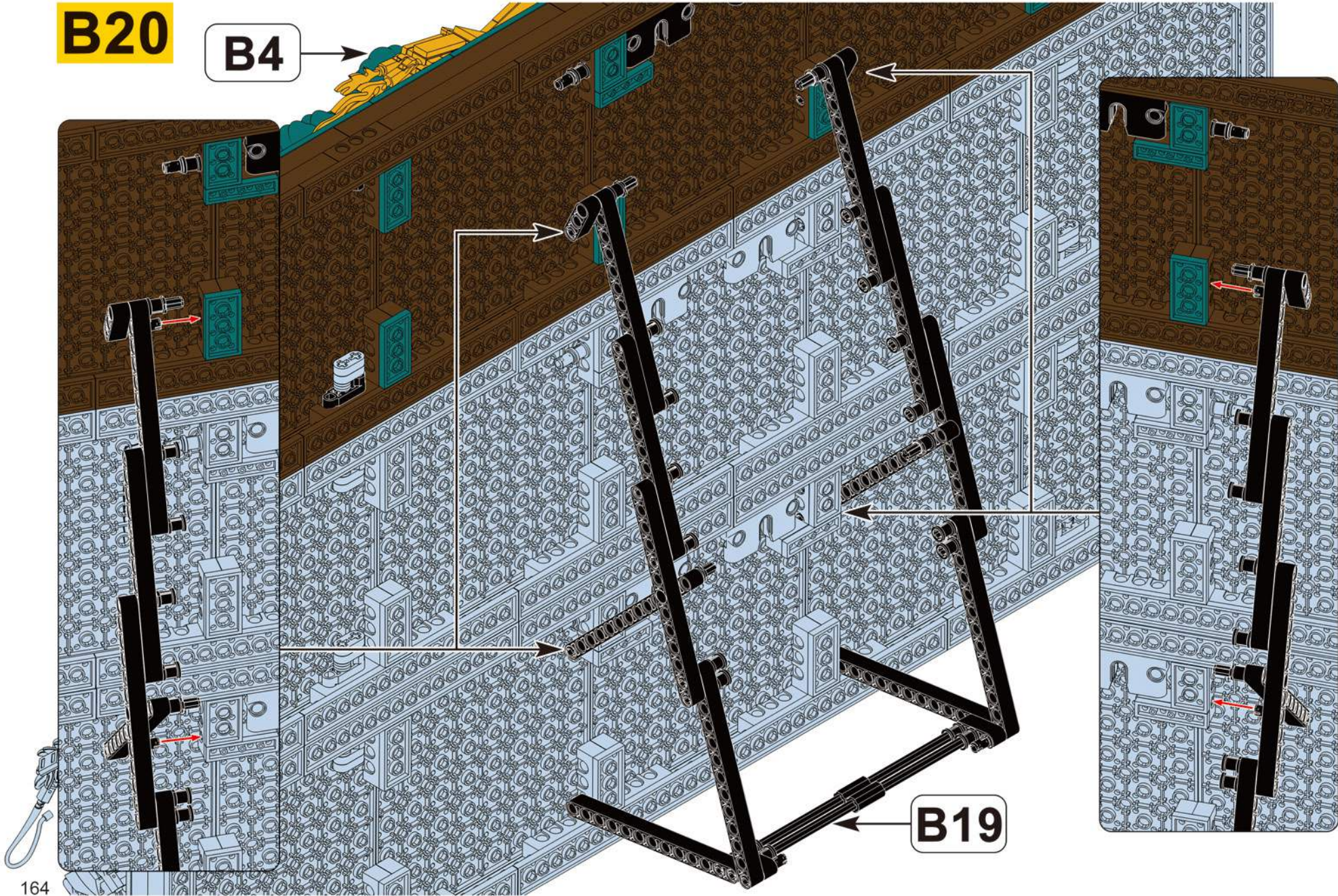

4  
2x 2x

# B21

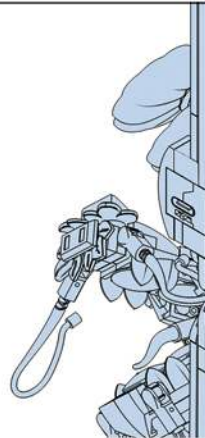
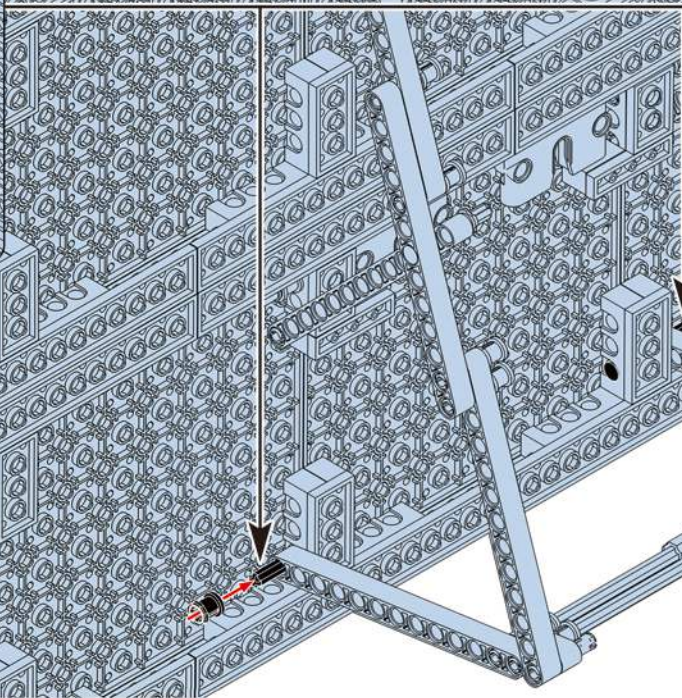
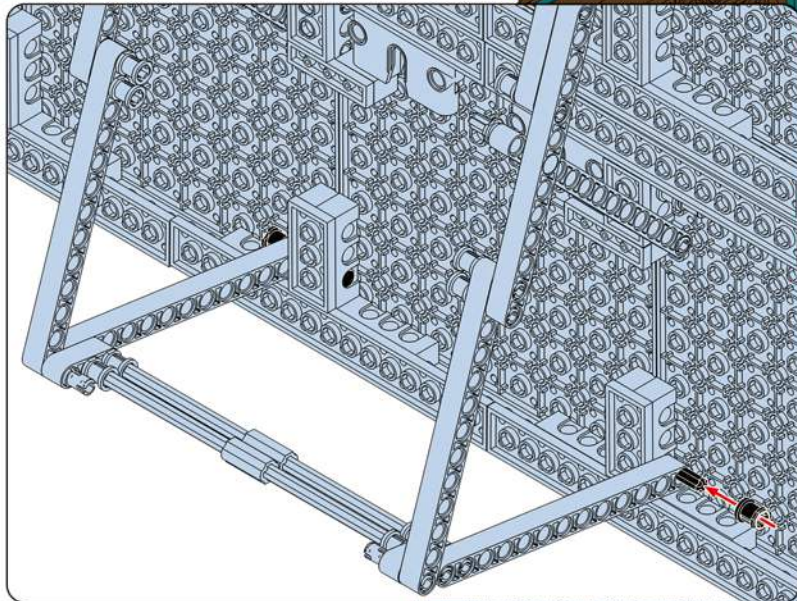

1:1 4

**C**

**4 IN 1**

This series of products can be assembled in a four in one combination. You can freely combine them by yourself. The following steps mainly demonstrate the combination assembly of NO.70019, NO.70020, NO.70021, and NO.70022.

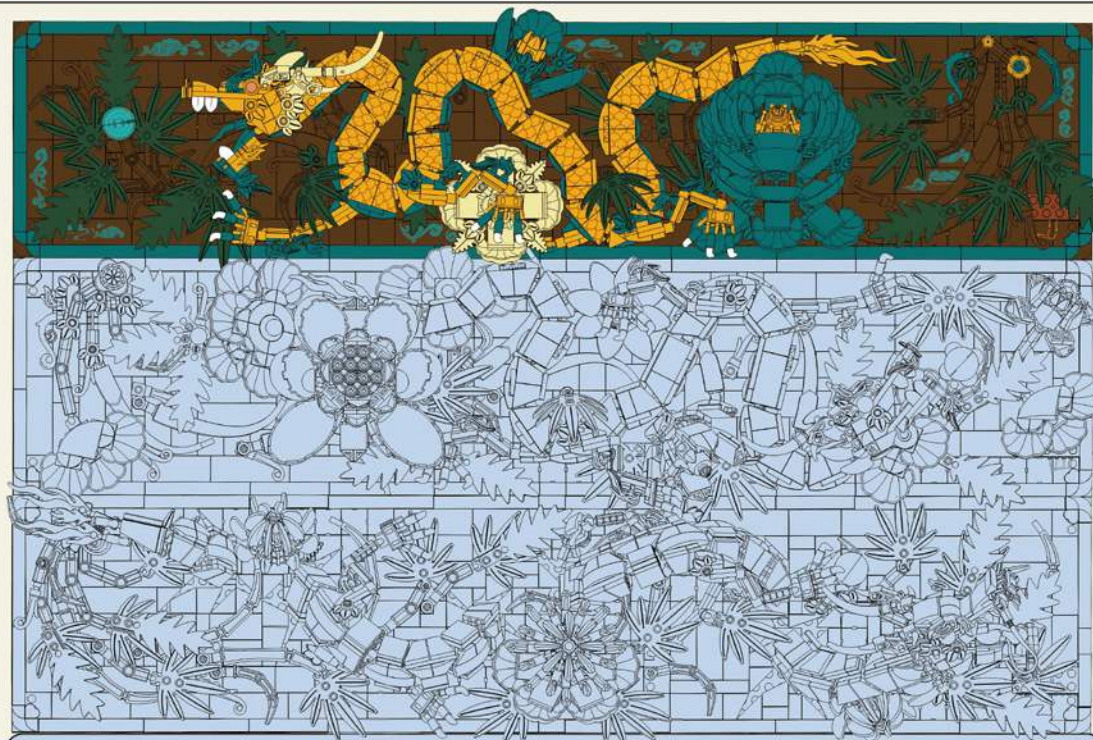

The new product 70022 is currently under design and will be launched soon.

# JOY MAKES BRILLIANCE.

14+  
AGES

## Embrace Relaxation Embrace Joy

Every adultescent needs a "JOY BOX".  
Please , open your JOY BOX ! Heading for joy.

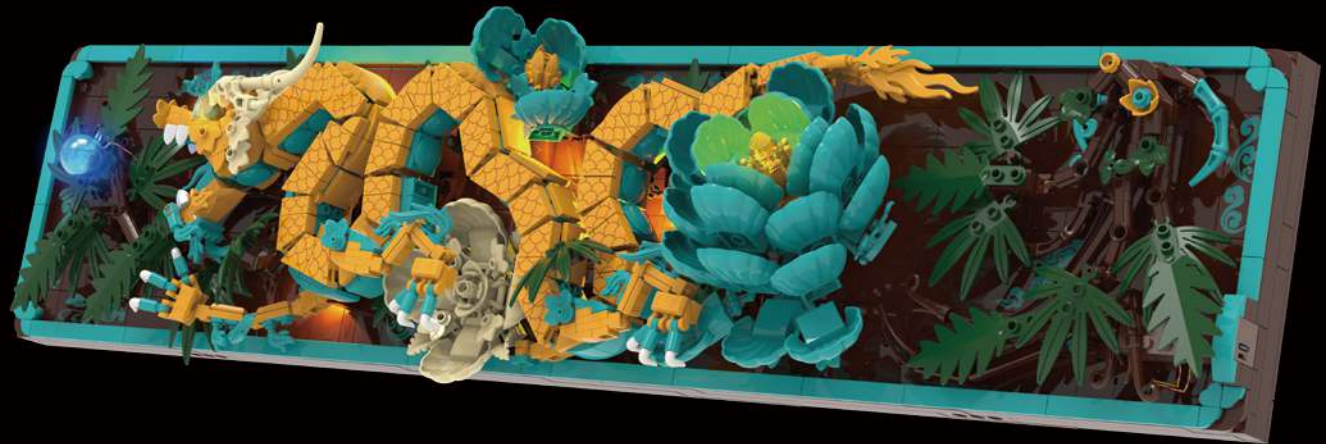

Thank you for choosing our JMB product.  
We would like to hear your thoughts on the new product you  
have just purchased. Your feedback will help shape the future  
development of this product line.  
You can contact us at <http://www.jmbricklayer.com> or via  
email at [Service@jmbricklayer.com](mailto:Service@jmbricklayer.com).

Vielen Dank, dass Sie unser JMB Produkt ausgewählt haben.  
Wir möchten Ihre Meinung zum gerade erworbenen neuen  
Produkt hören. Ihr Feedback wird dazu beitragen, die zukünftige  
Entwicklung dieser Produktsreihe zu gestalten.  
Kontaktieren Sie uns über [www.jmbricklayer.com](http://www.jmbricklayer.com) oder per  
E-Mail an [Service@jmbricklayer.com](mailto:Service@jmbricklayer.com).

# BRICK IT HAPPEN



**40001**

Ghost Ship The Flying Dutchman



**50001**

Vintage Car Model A Deluxe Coupe



**20039**

Vintage 3 in 1 Set



**70013**

Mantis Shrimp



**70008**

Rainbow Unicorn



**70010**

Swimming Jellyfish



**70011**

Mechanical Hummingbird



**70016**

Impression Sunrise



**70017**

Phoenix Nirvana



**70015**

Woodland Pegasus



Dear valued customer,  
We sincerely hope you enjoy the product and we can't wait to see you again soon. Please let us know if we can do anything else to help! If you are pleased with your purchase and plan to buy from us again, we have a special offer just for you. When making your payment, please utilize the exclusive discount code "JMBVIP28A6" to avail yourself of a generous 20% discount.

**14+**  
**AGES**

Long-term Effective  
**20% OFF**  
Discount Code  
**JMBVIP28A6**

Available on [www.jmbricklayer.com](http://www.jmbricklayer.com)  
Online store Support: [Support@jmbricklayer.com](mailto:Support@jmbricklayer.com)

# BRICK IT HAPPEN

---



**60014**  
Strategic Nuclear Submarine



**40002**  
Age of Exploration The Black Pearl



**60015**  
Bismarck Class Battleship



**70019**  
Mythic Dragon Tiles



**70003**  
Dinosaur Factory

---



**JMBricklayer**

---

## Embrace Relaxation Embrace Joy

---

Every adultescent needs a "JOY BOX".  
Please , open your JOY BOX ! Heading for joy.

