



拼奇积木



TIME MORE®

咖啡工坊



COFFEE FACTORY

11021



TIME MORE®

\ MORE TIME FOR COFFEE LIFE /



— ENJOY COFFEE LIFE —

太简单
玩咖设备MAX!!!



旋转把手



旋转调整水壶方向



可升降支架



支架底部可旋转



栗子C3研磨器



黑镜2.0手冲架



鱼Pure手冲壶



拼魁1.0咖啡豆

咖啡工坊



拼奇积木

为收藏而生

这么拼更快哦！



·别着急,大多数的“缺件”情况都只是零件暂时走丢了,再仔细找找看吧!

·也可以扫码关注拼奇官方公众号,点击【官方补件】进行申请,即可享受官方极速补件服务。

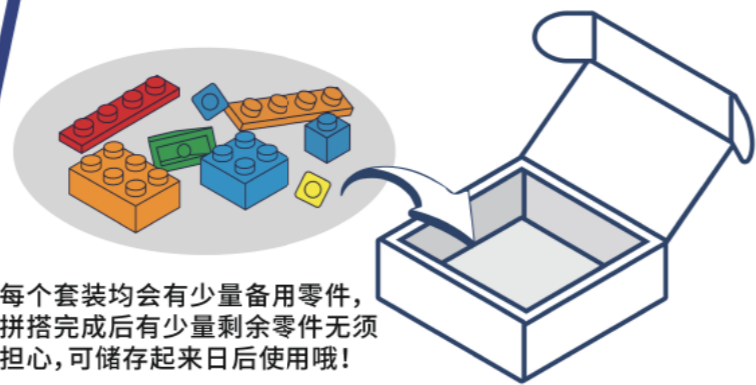

每个套装均会有少量备用零件,拼搭完成后有少量剩余零件无须担心,可储存起来日后使用哦!

1.找不到零件了?

2.拼搭后有零件剩余?

起件器使用方法

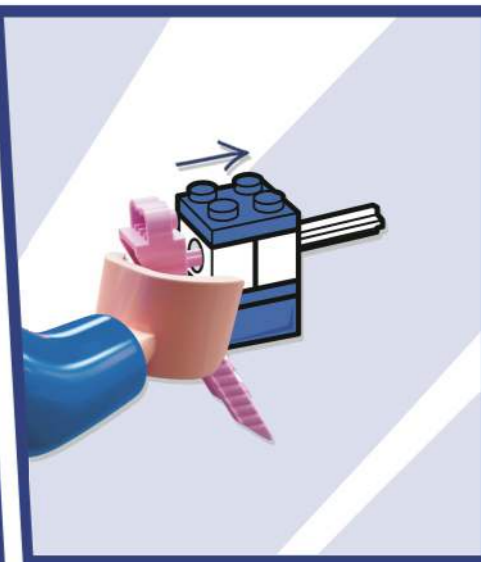
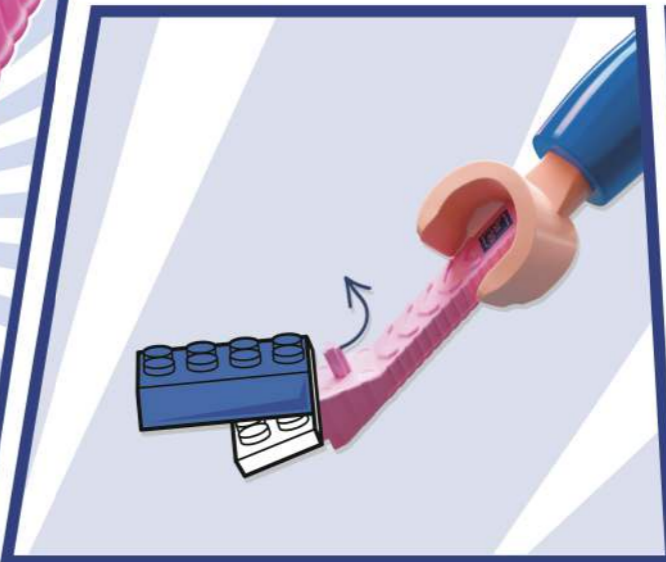
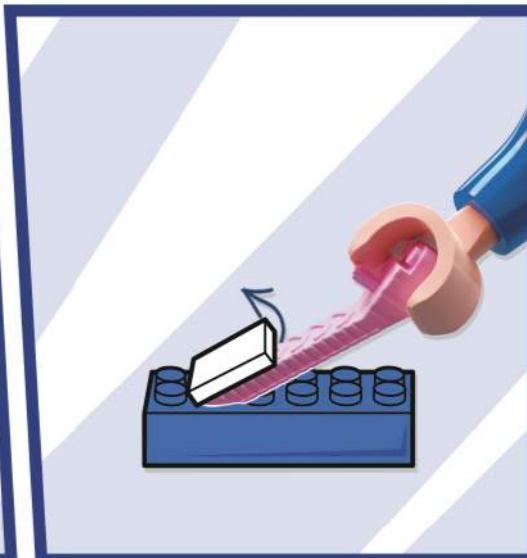
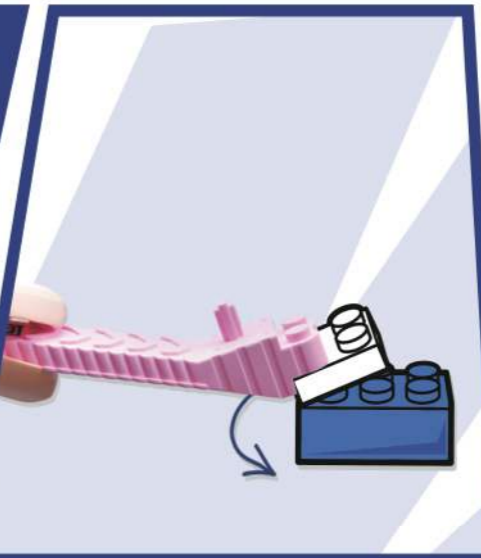

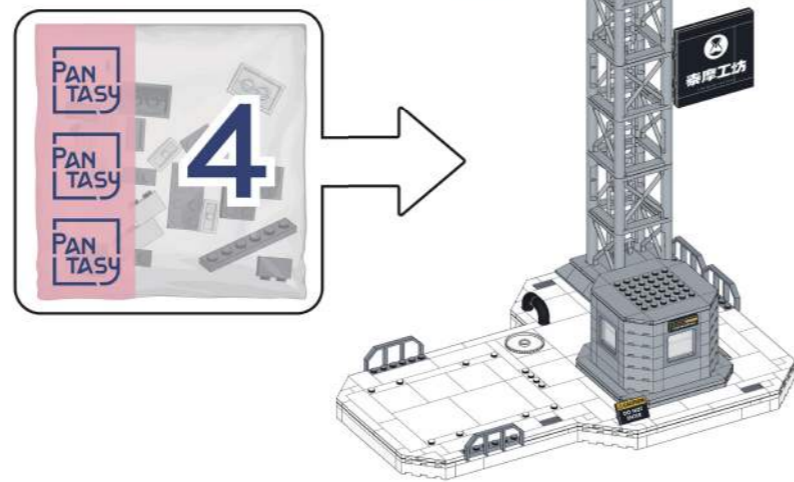
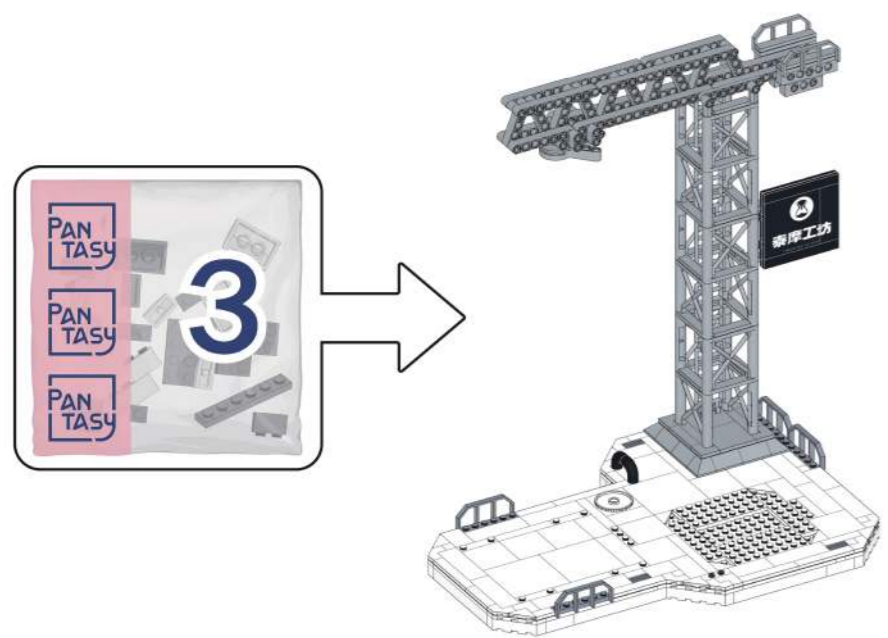
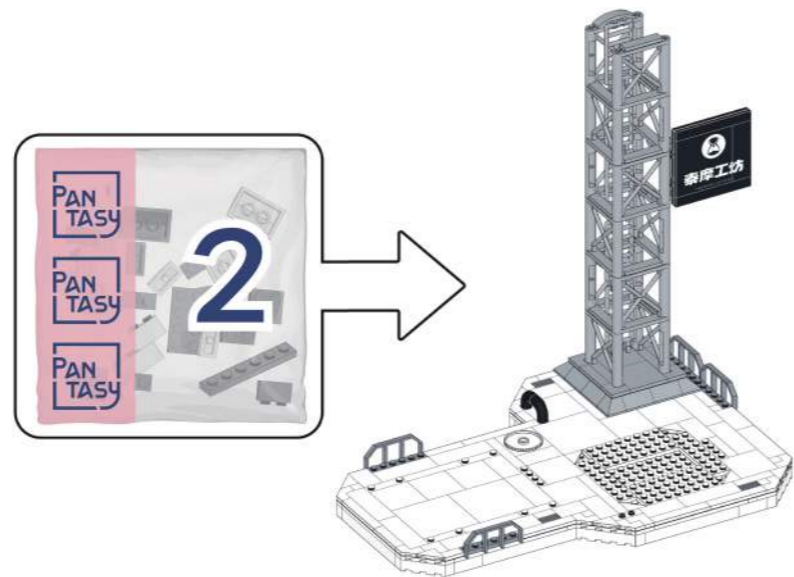
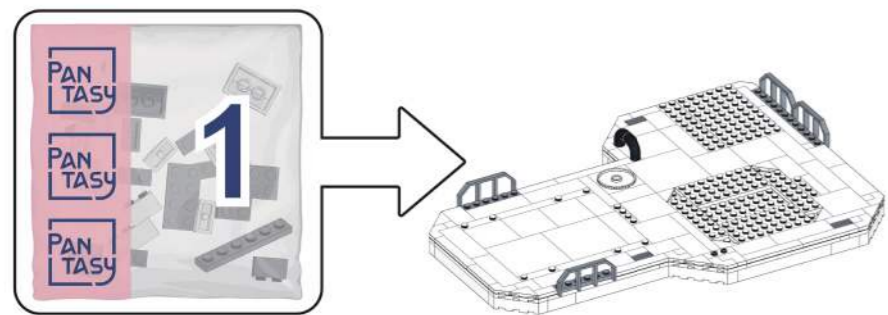

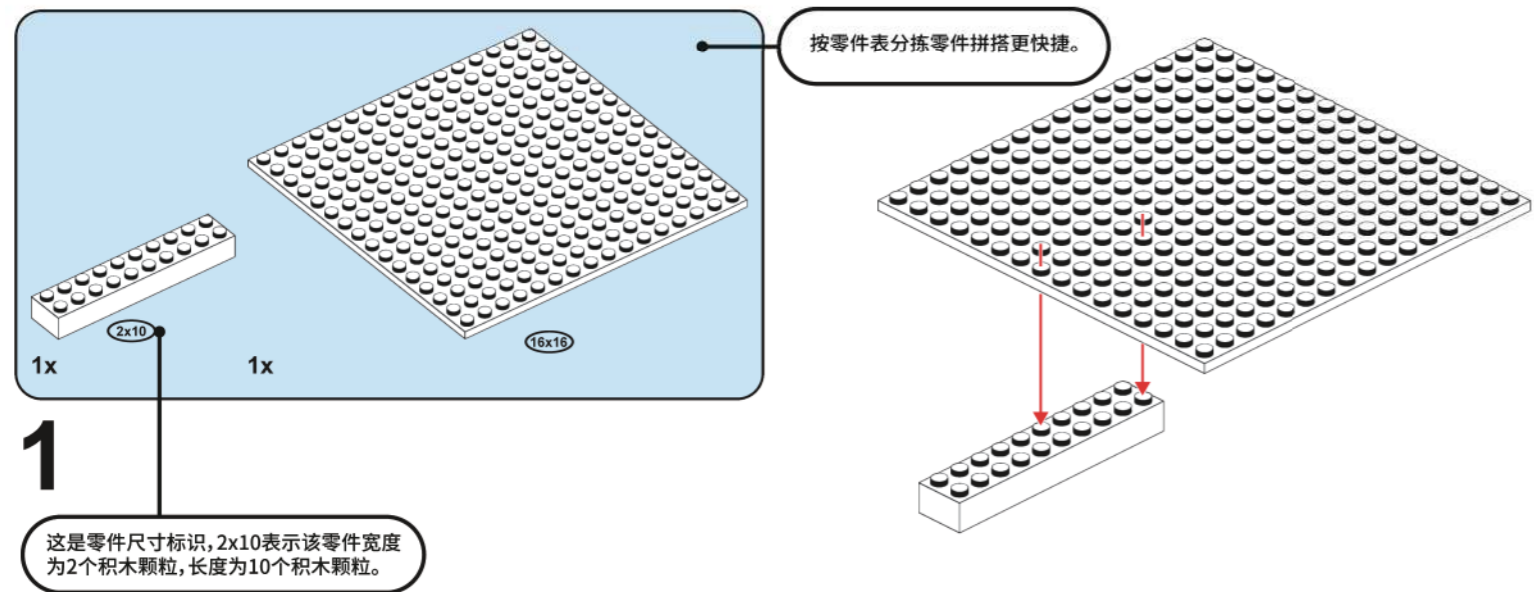
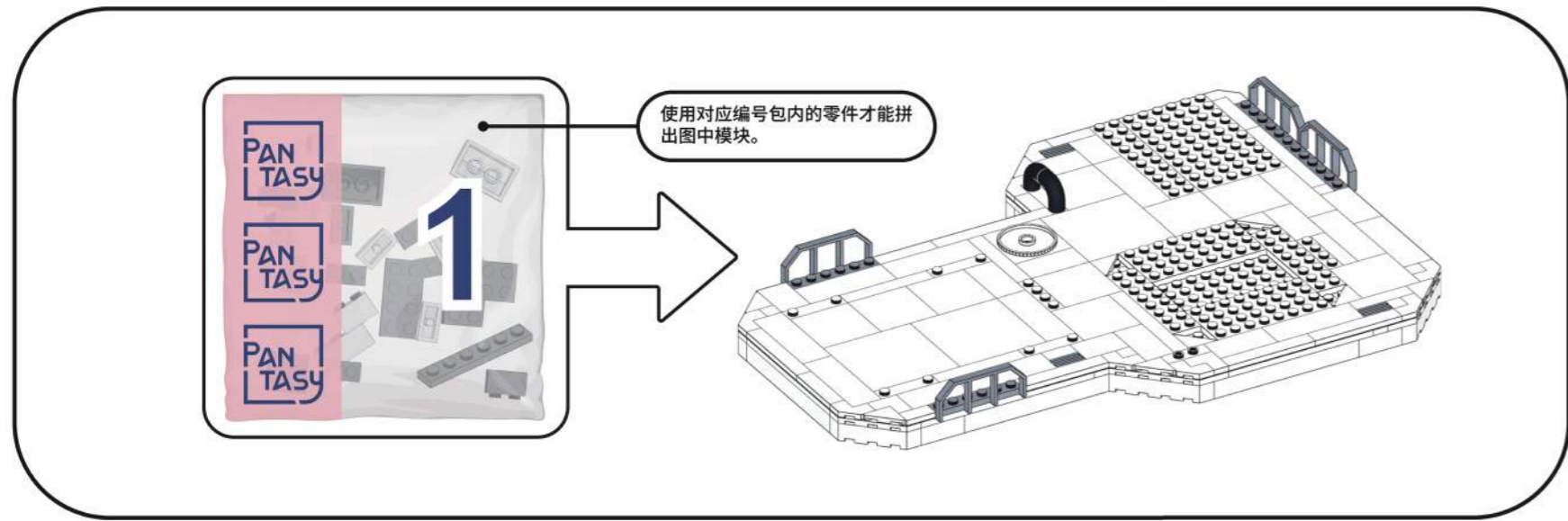

1

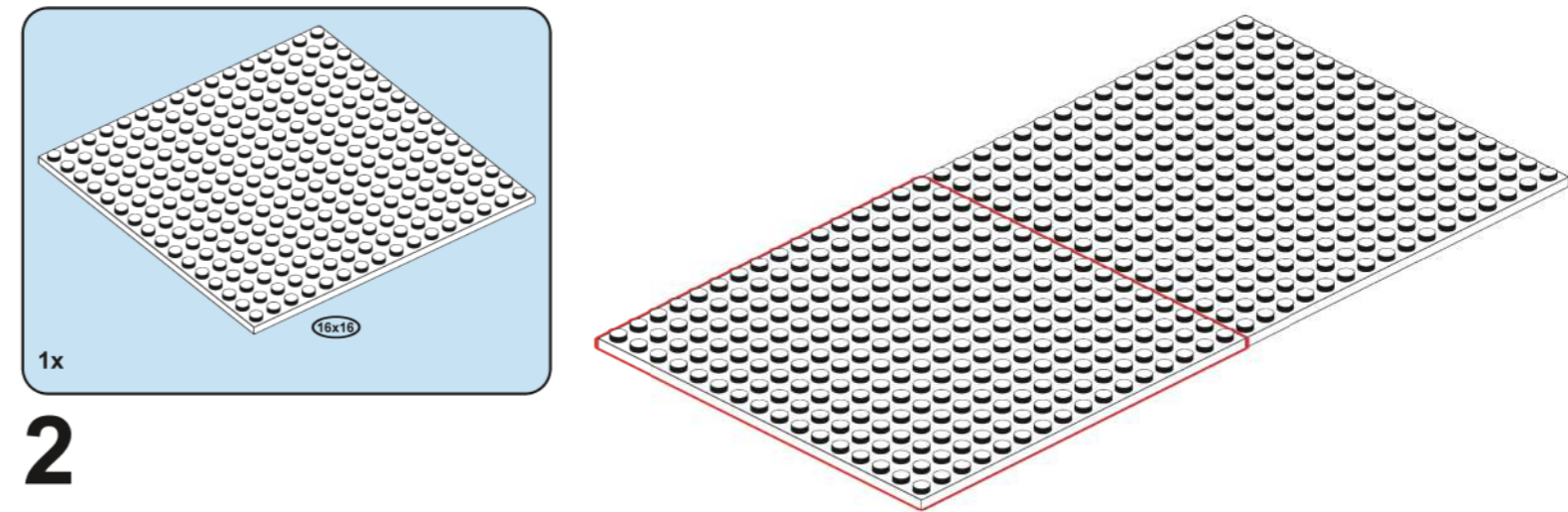

2

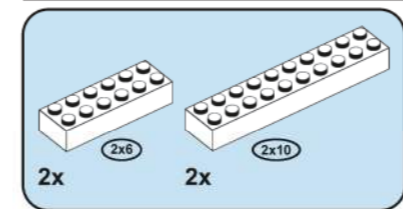

3

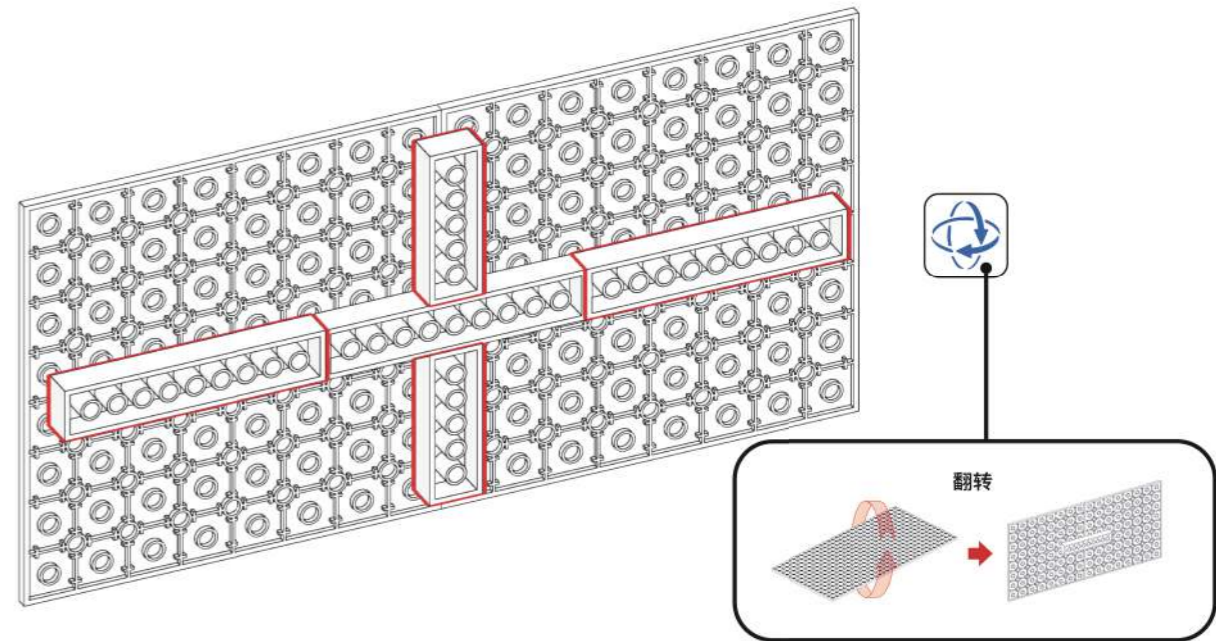

2

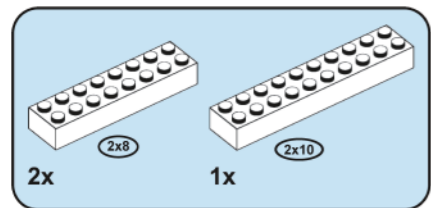

4

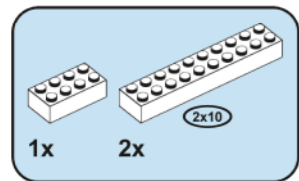
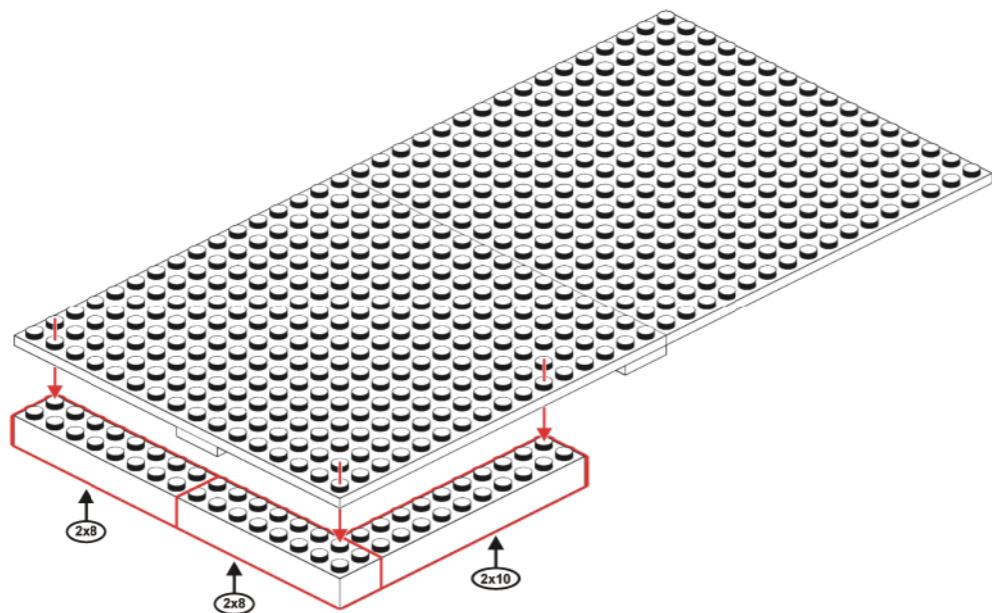

5

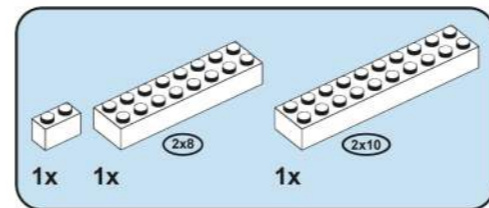
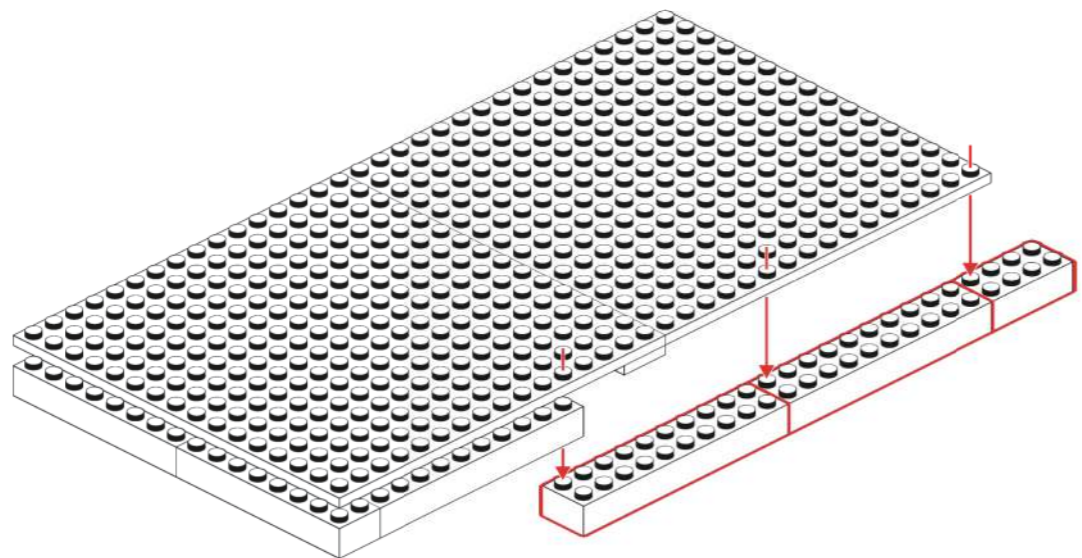

6

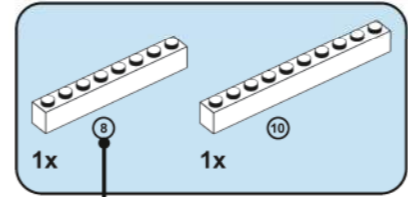
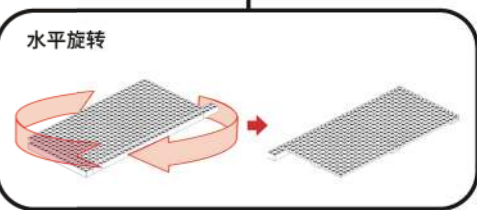
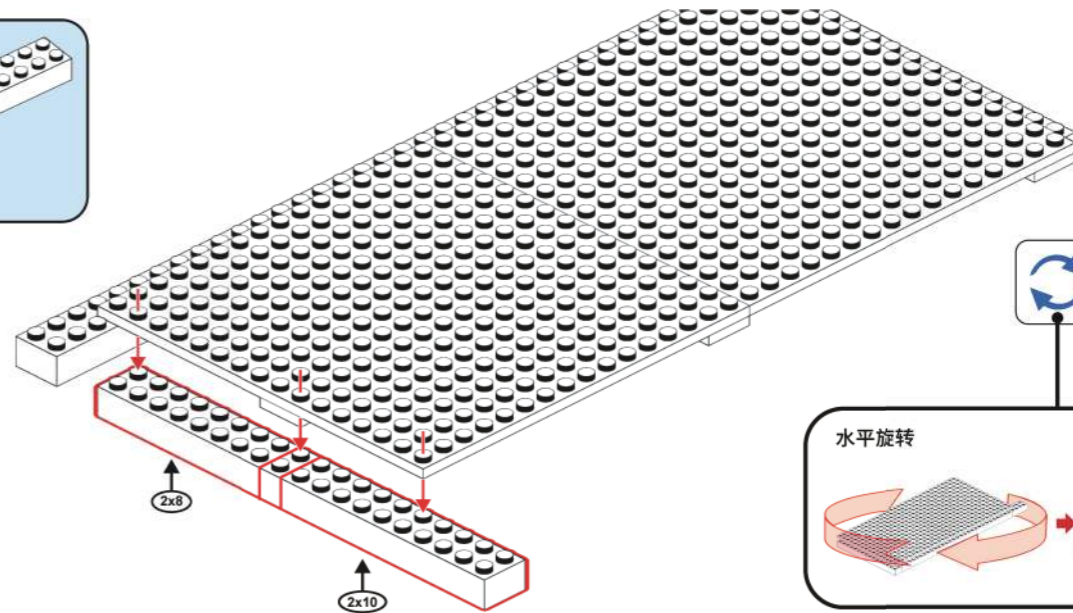

7

这是零件长度标识, 8代表该零件长度为8个积木颗粒。

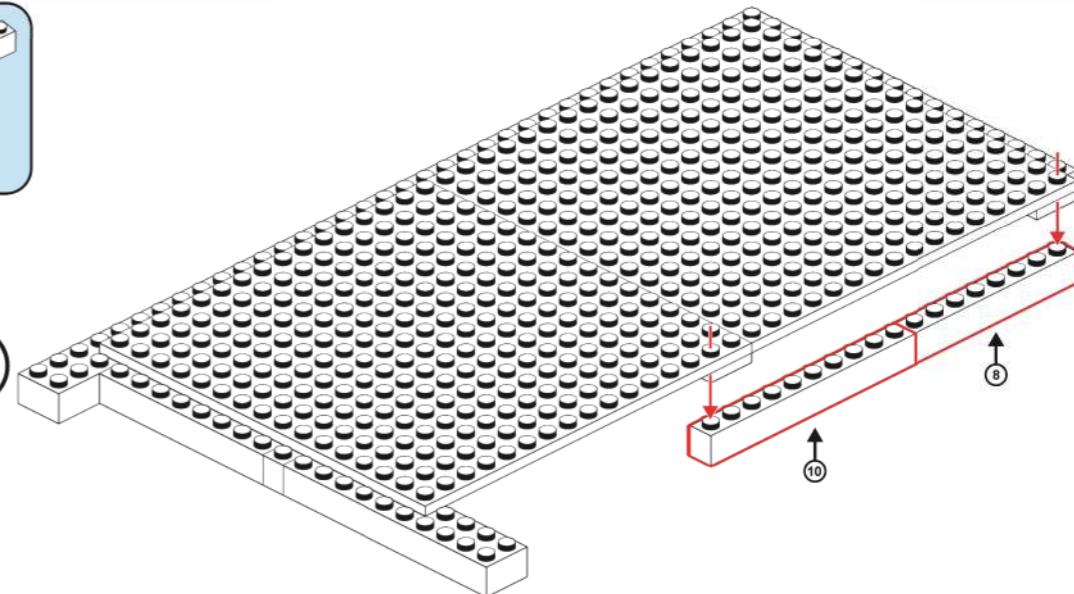

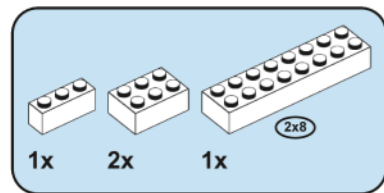

8

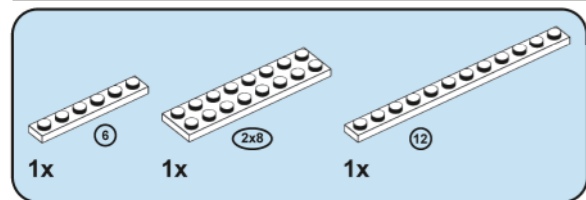
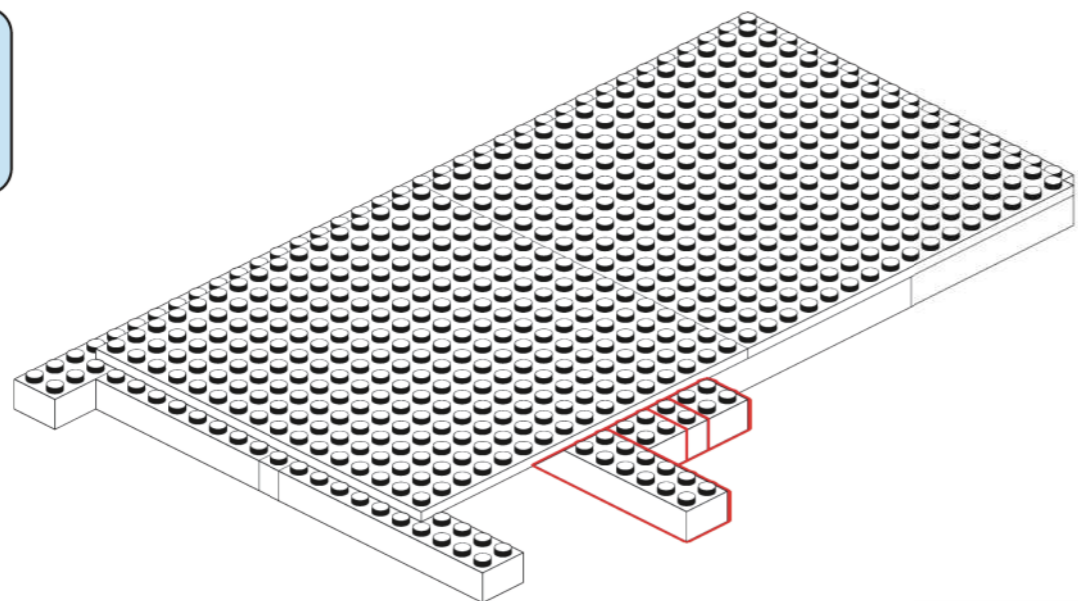

9

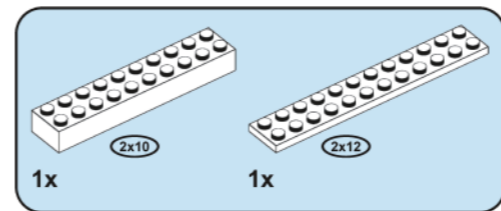
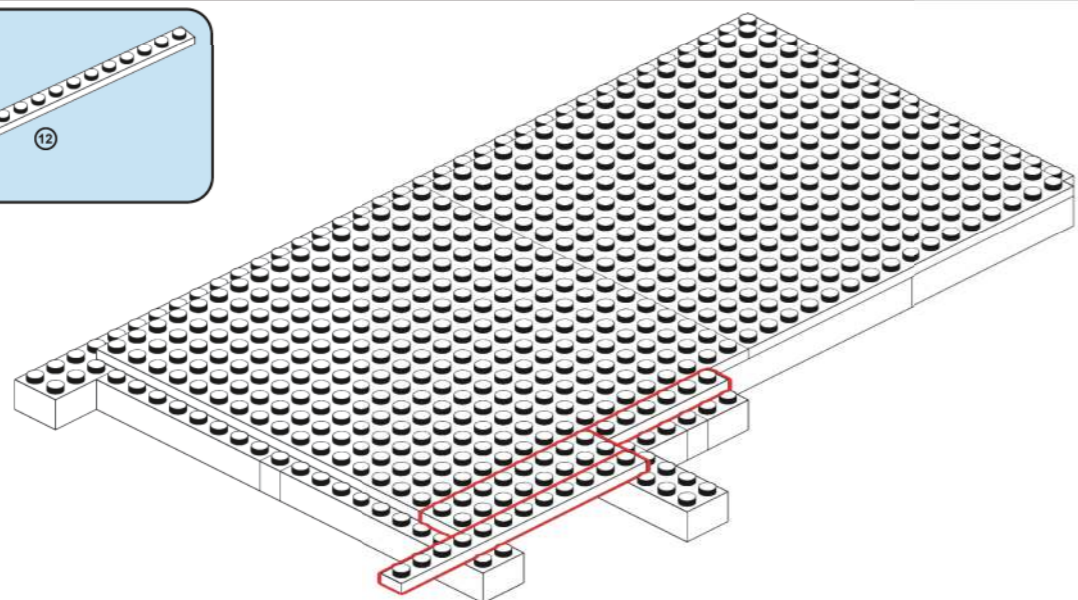

10

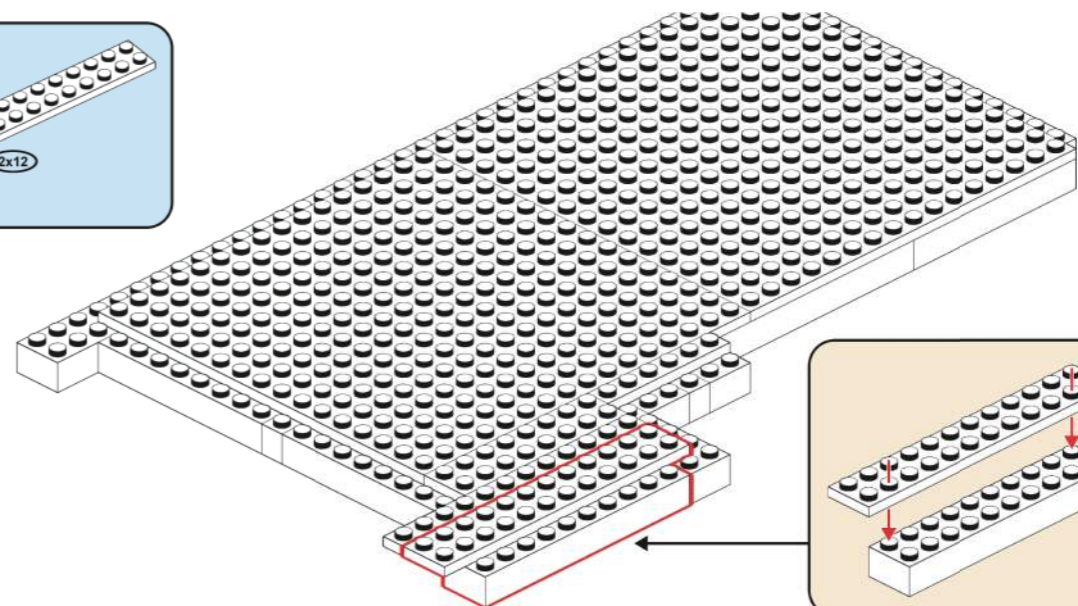

根据小图中步骤拼装此模块会更容易。

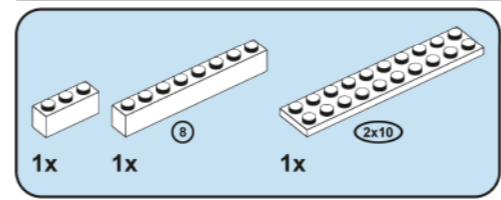

11

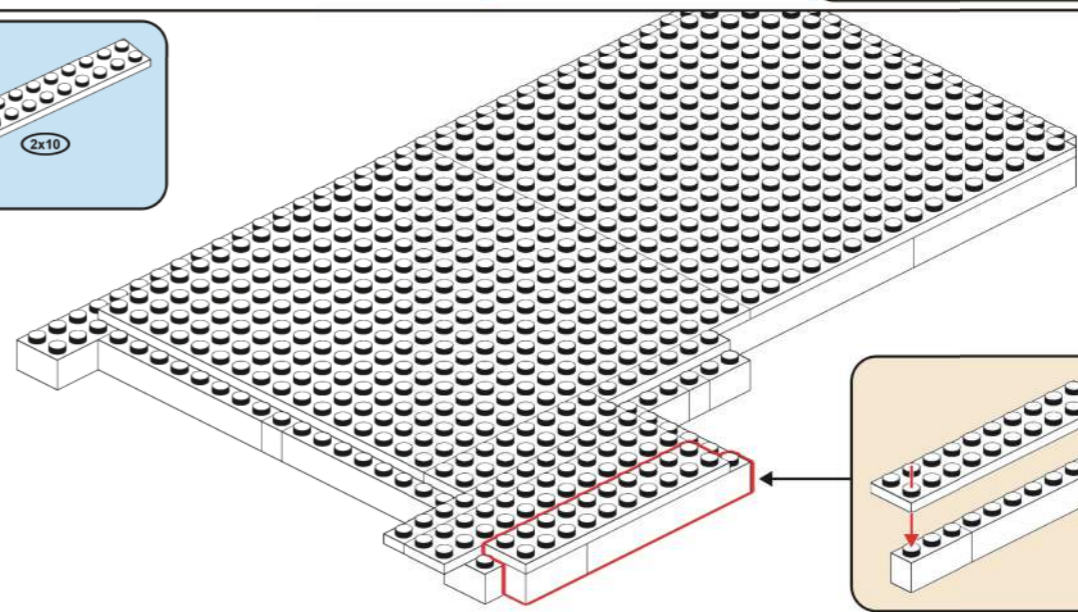

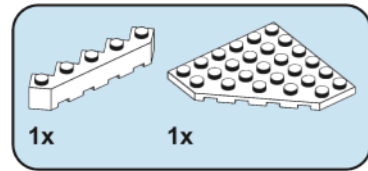

12

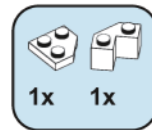
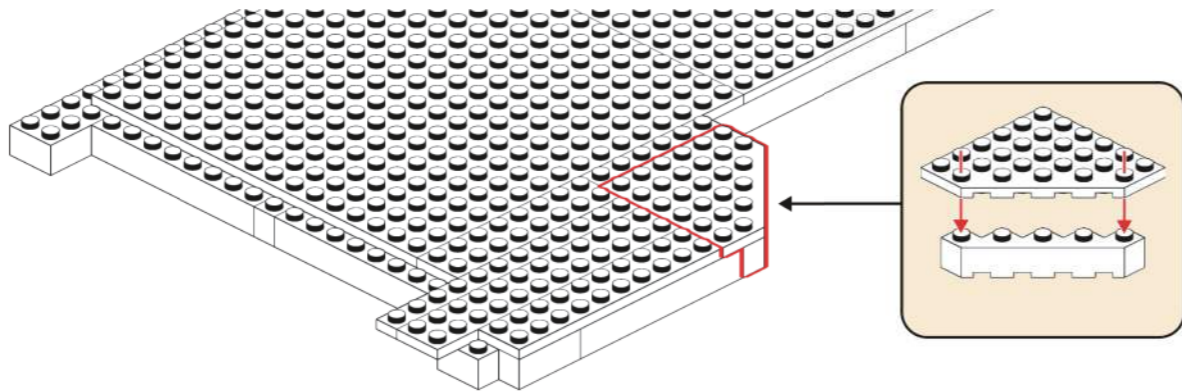

13

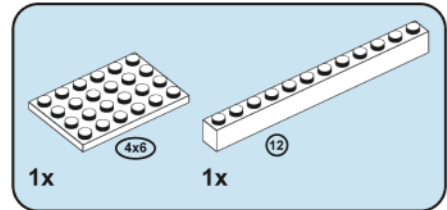
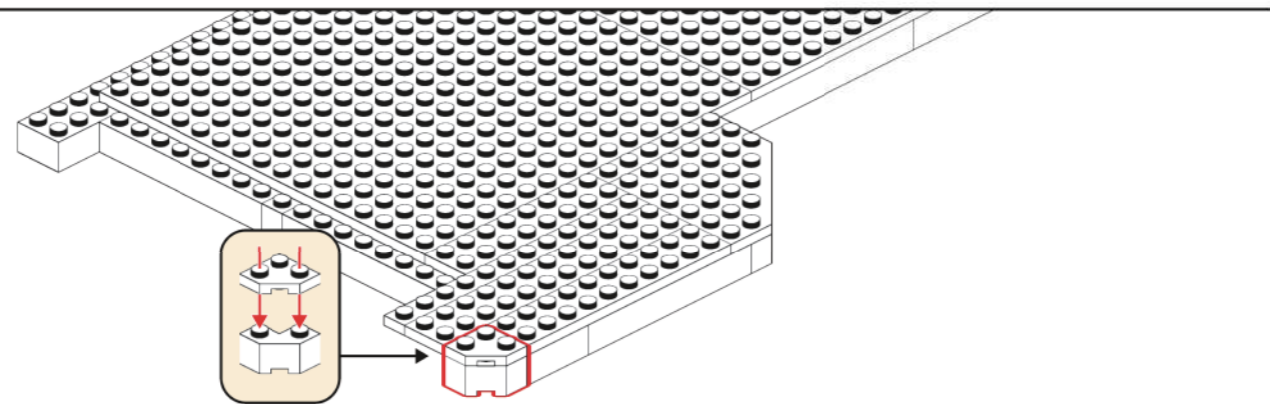

14

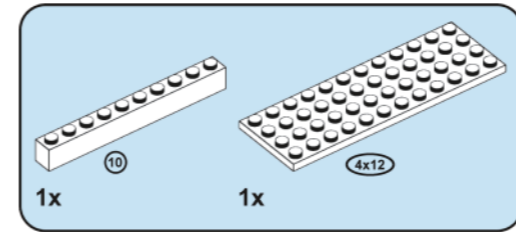
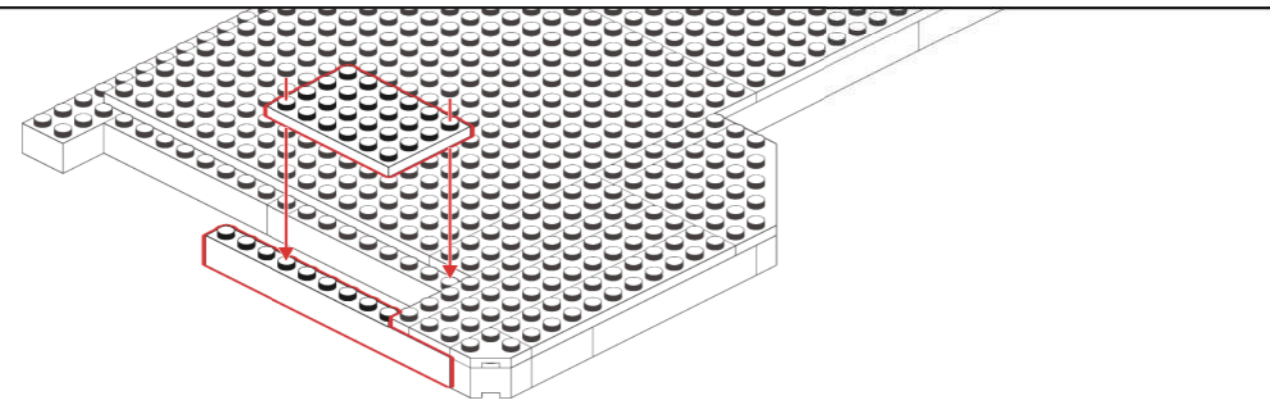

15

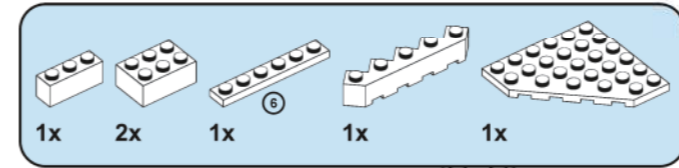
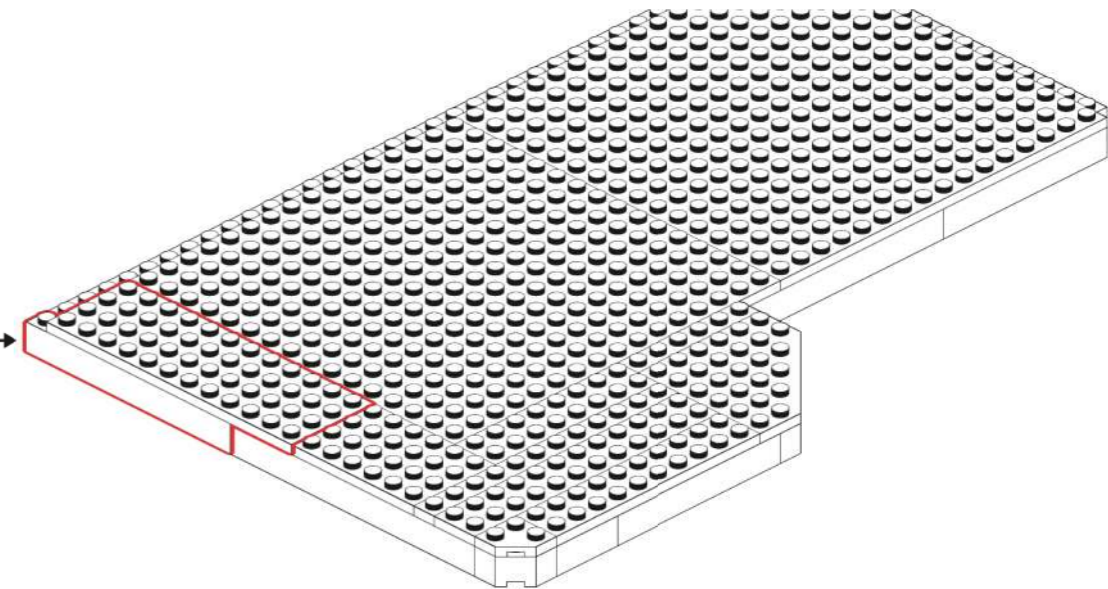
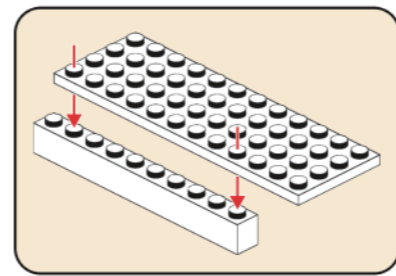

16

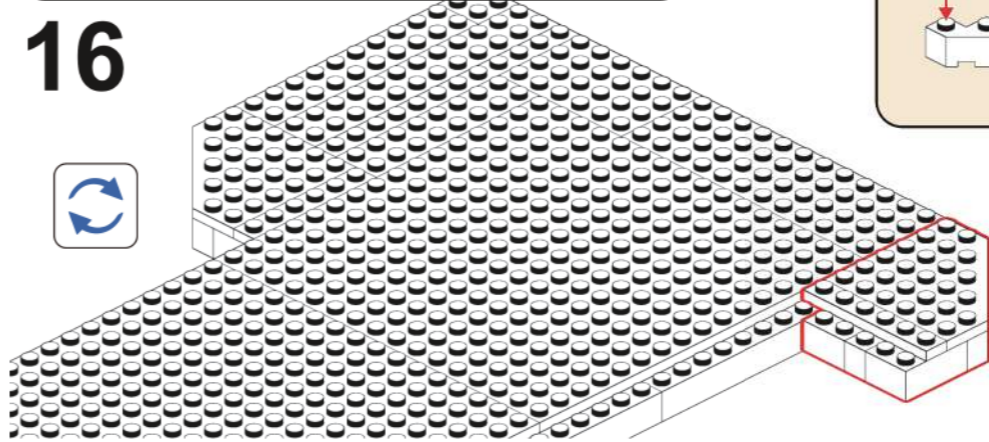
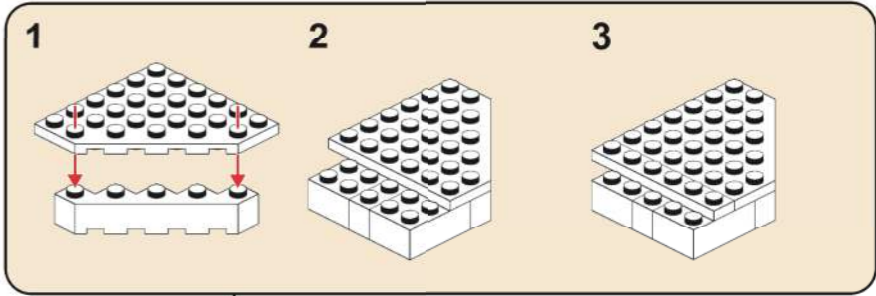

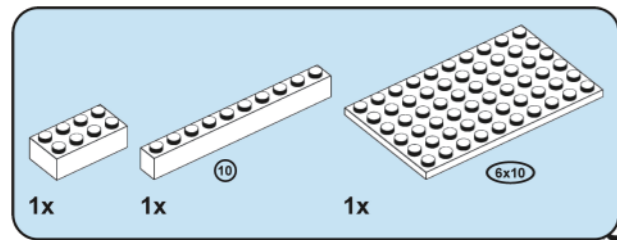

17

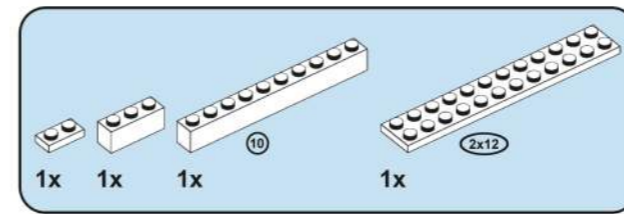
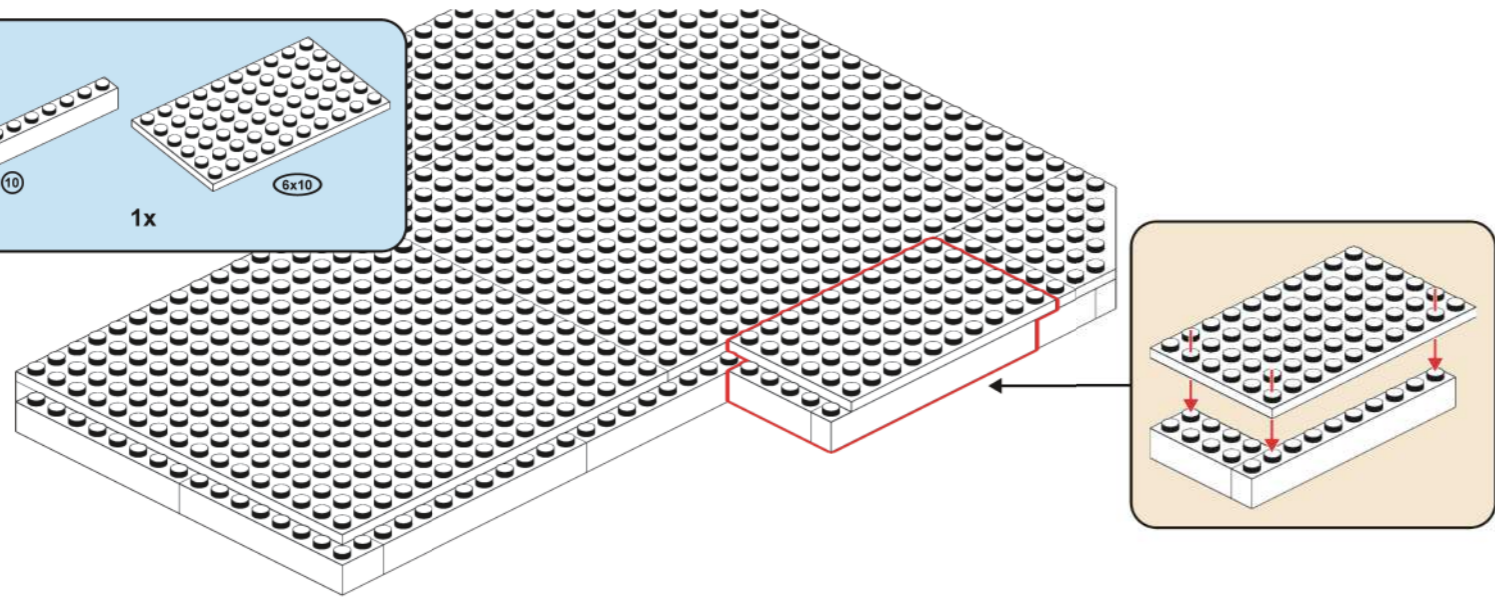

19

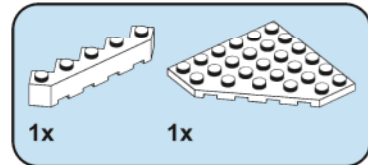
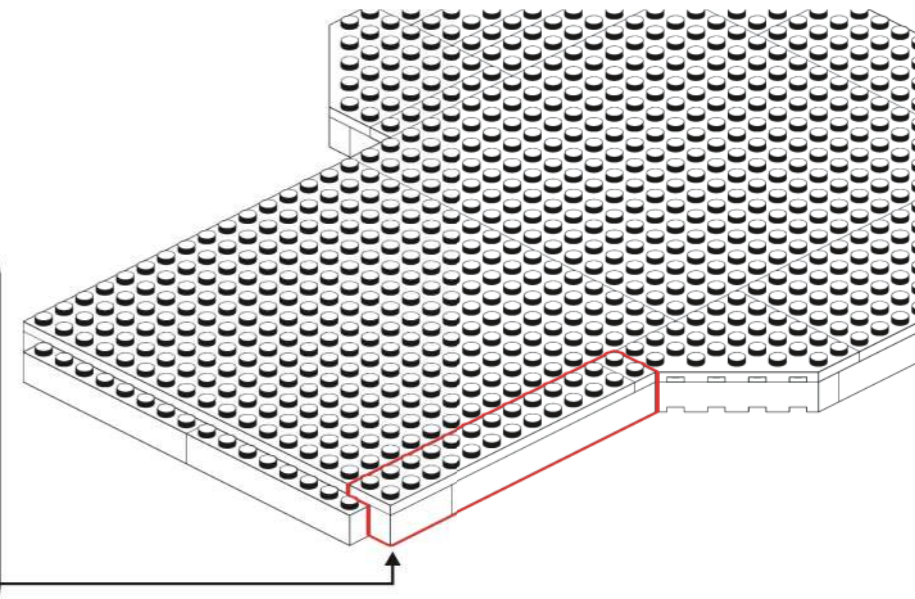
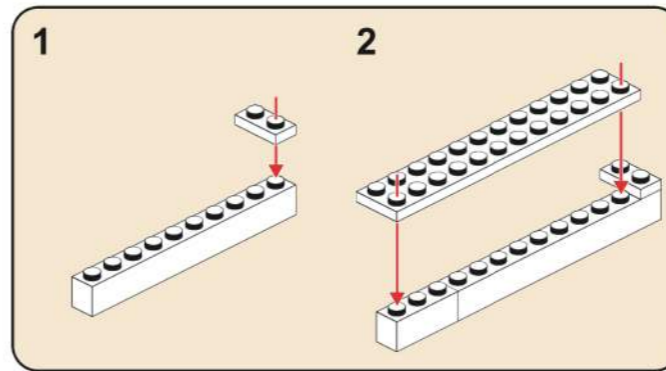

18

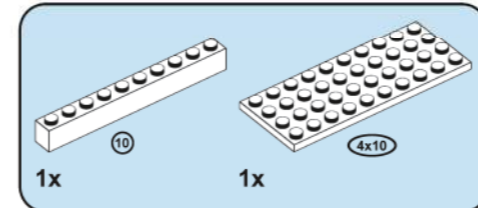
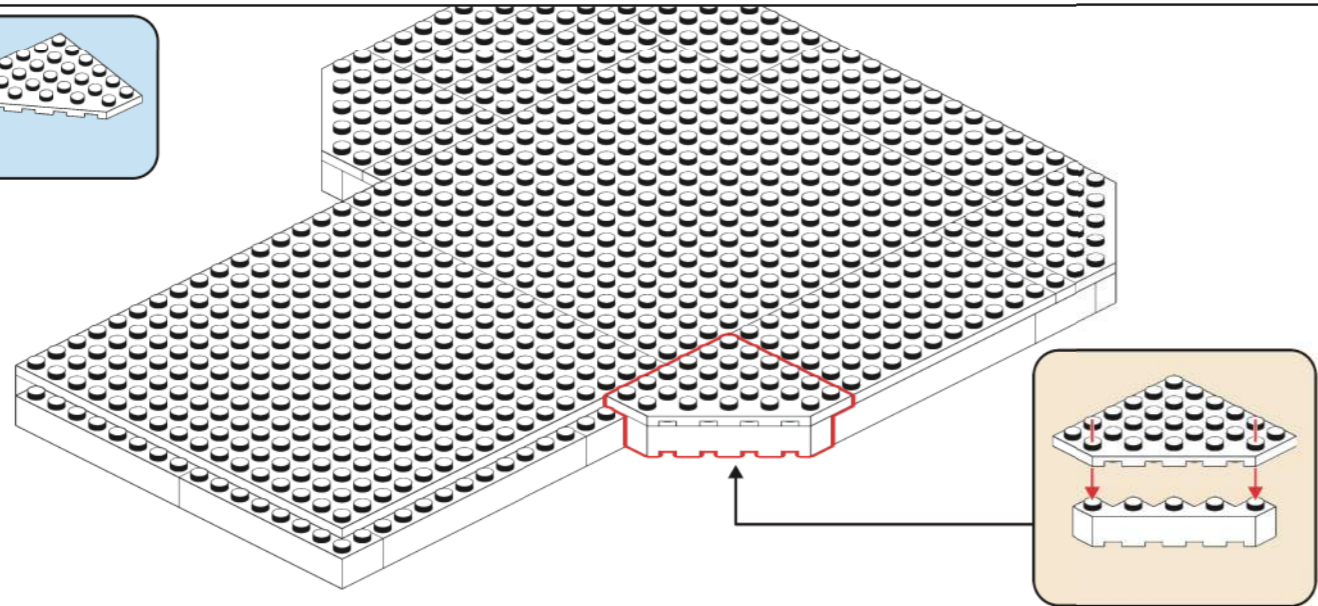

20

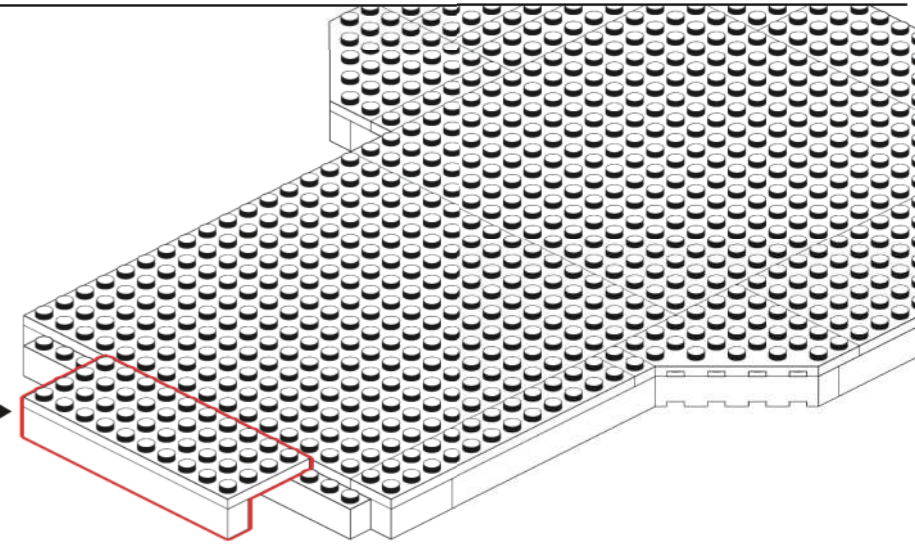
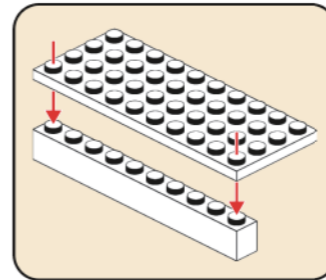

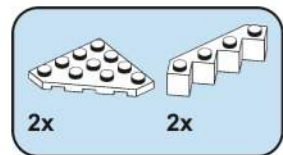

21

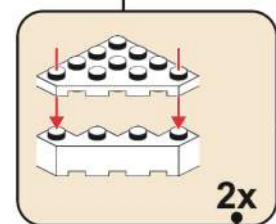
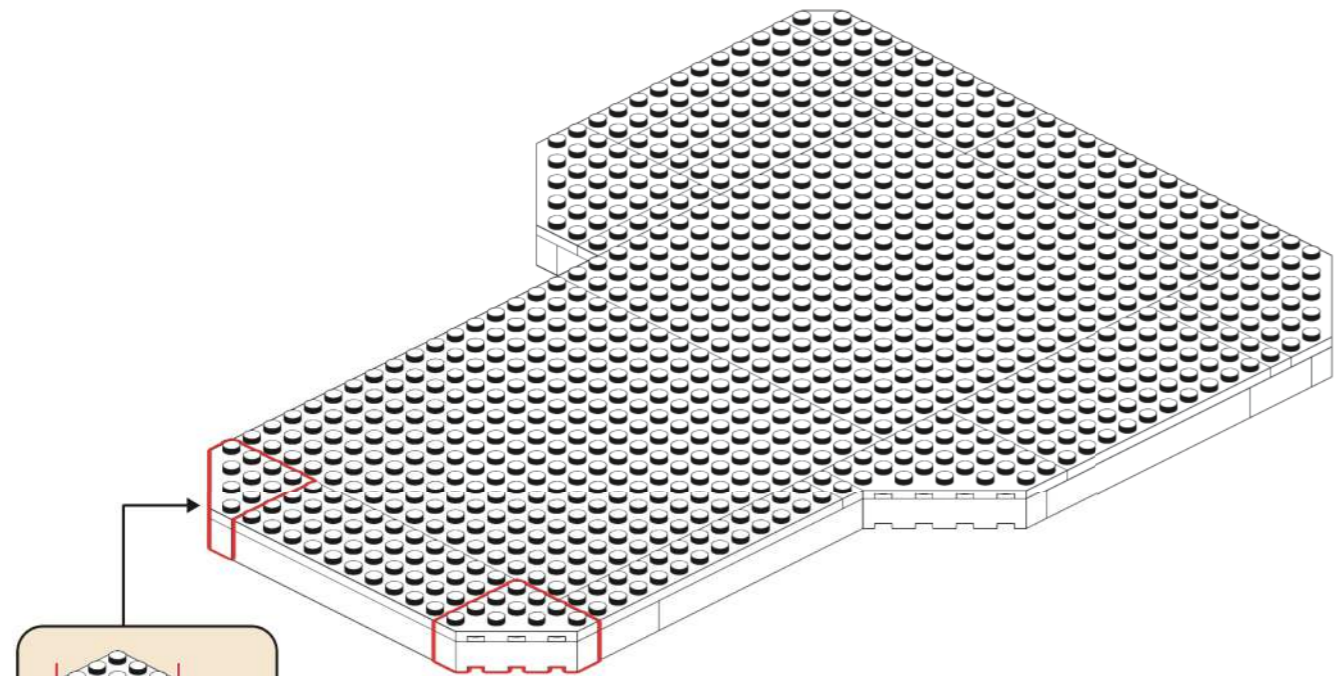

2x

2x表示该模块需要拼2个。

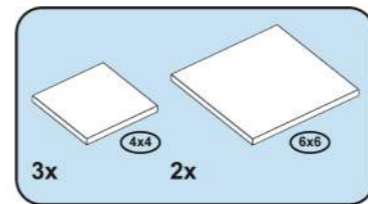

22

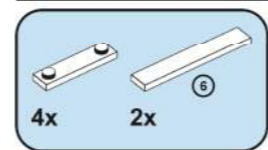
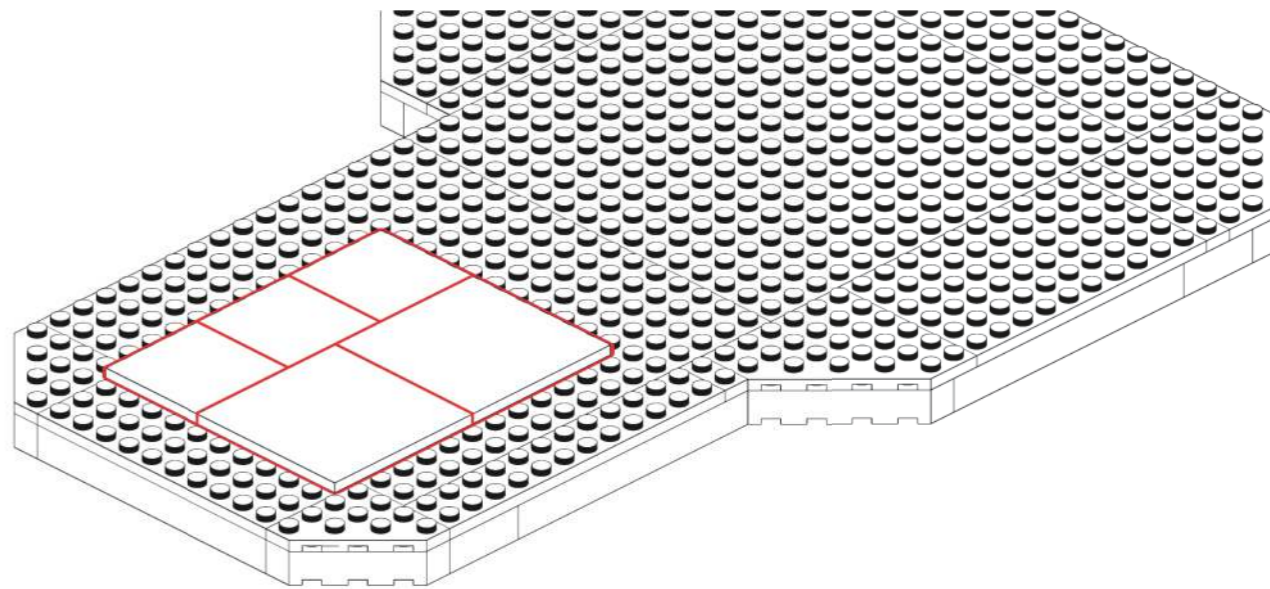

23

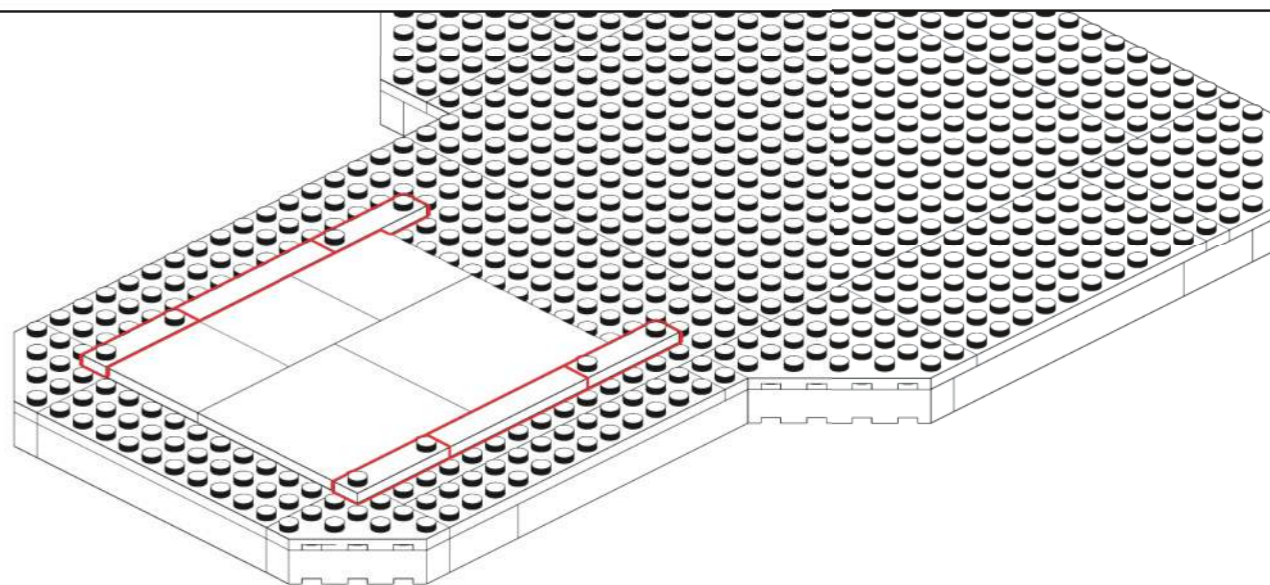

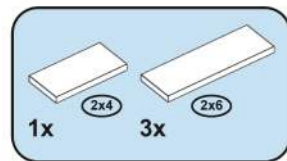

24

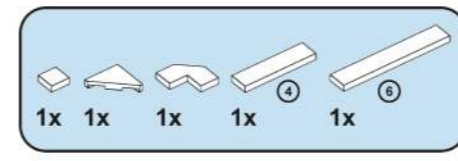
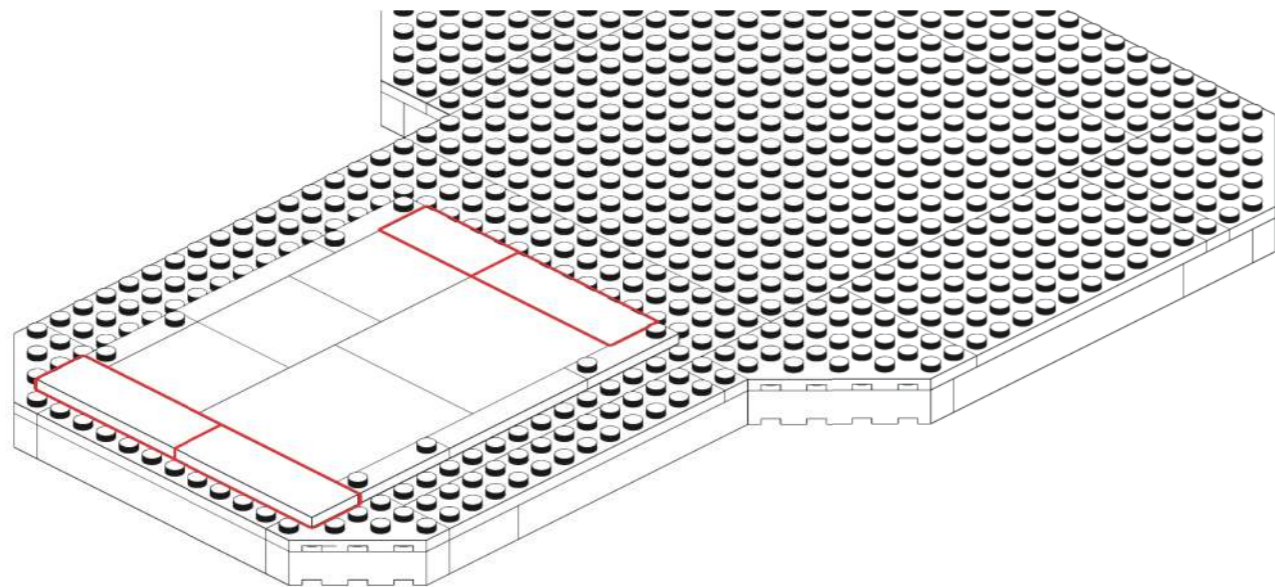

26

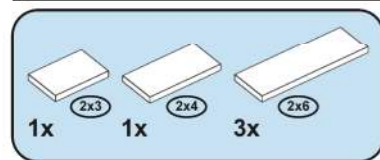
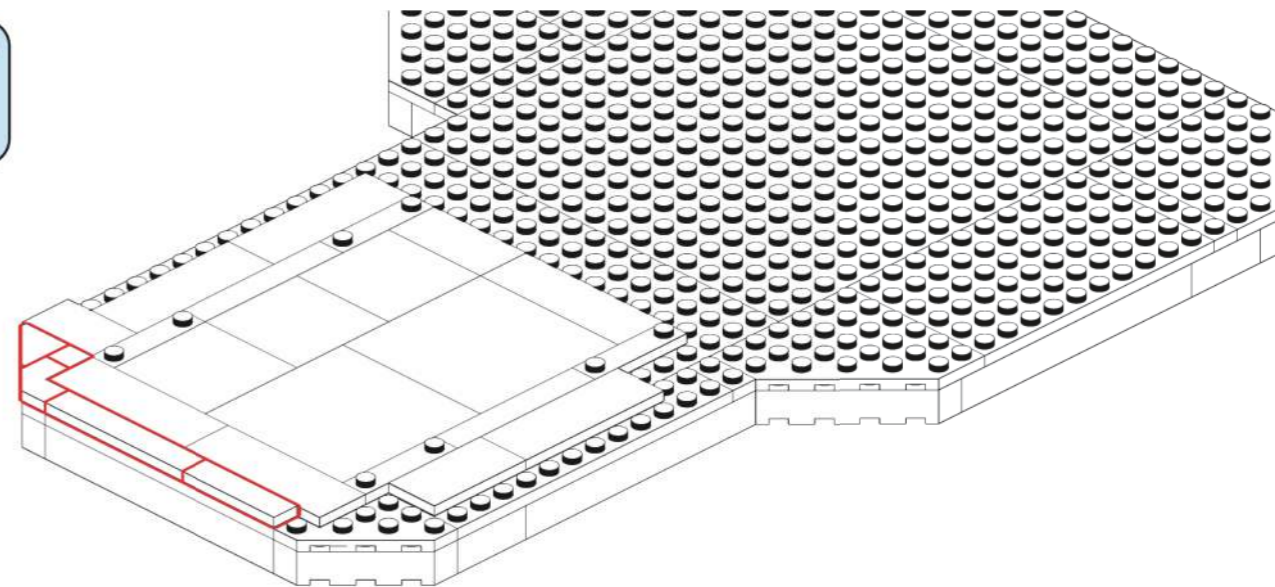

25

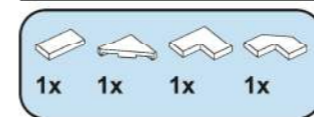
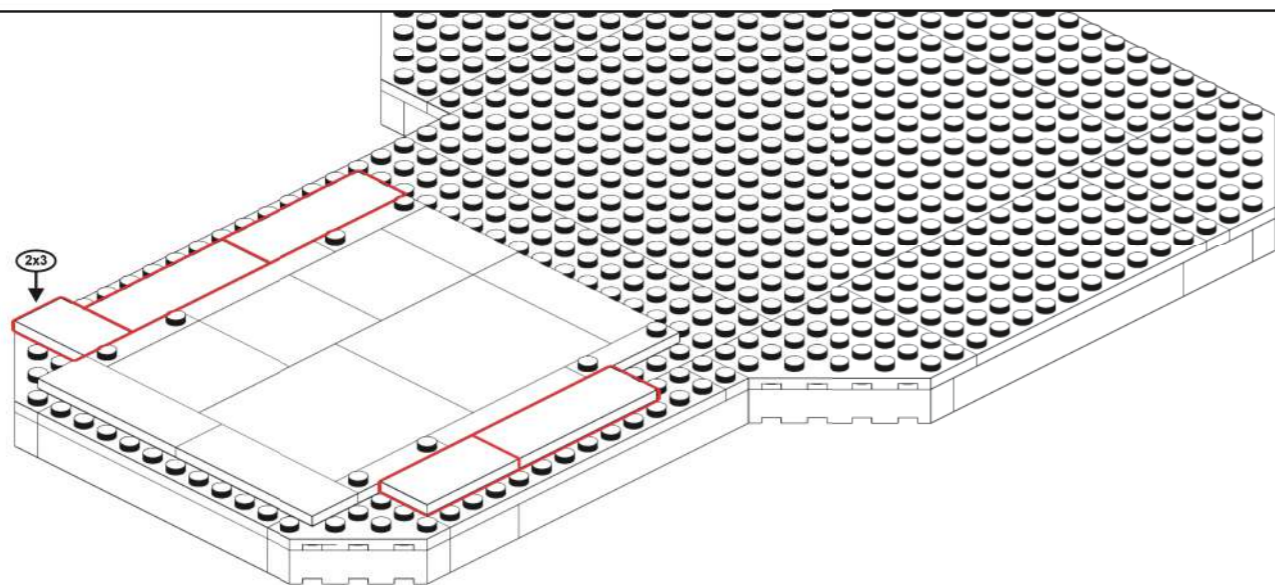

27

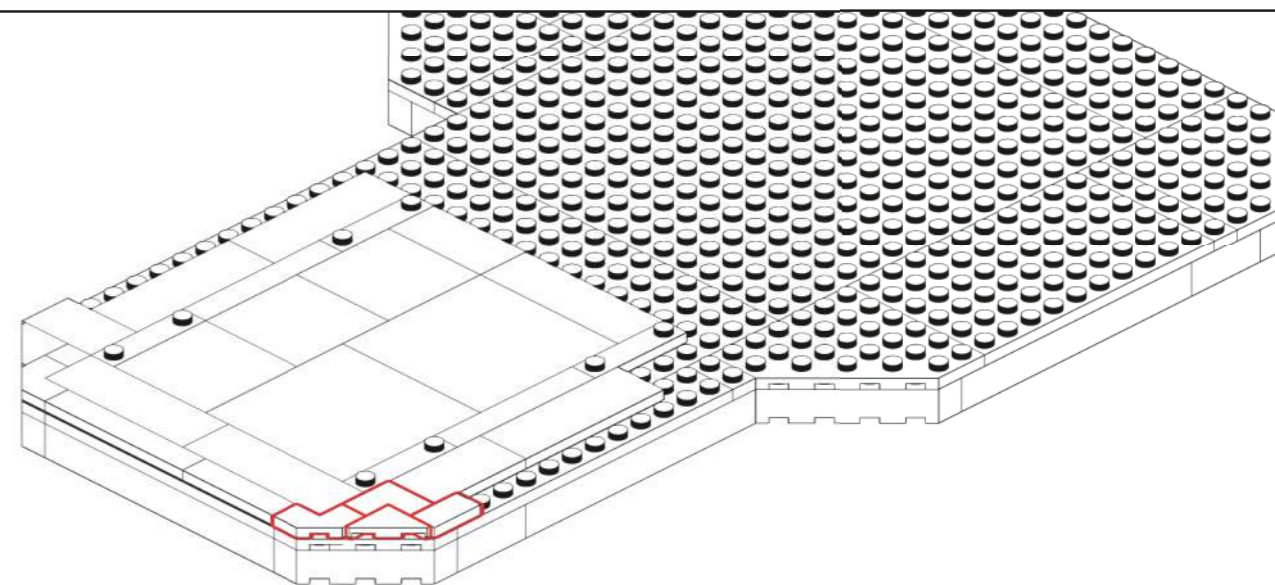

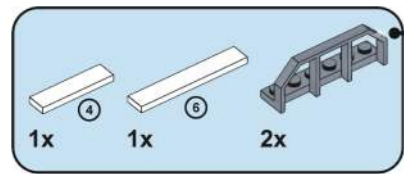

有星星标志的零件为金属质感零件。

28

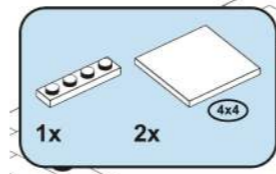
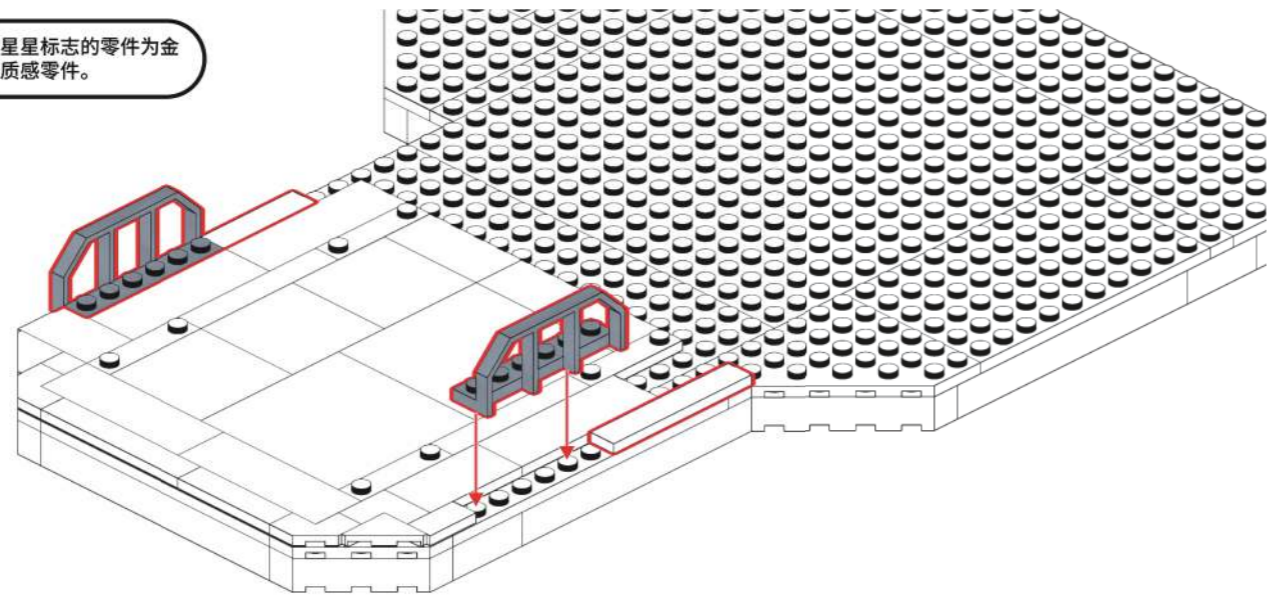

30

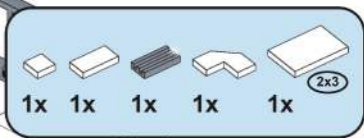
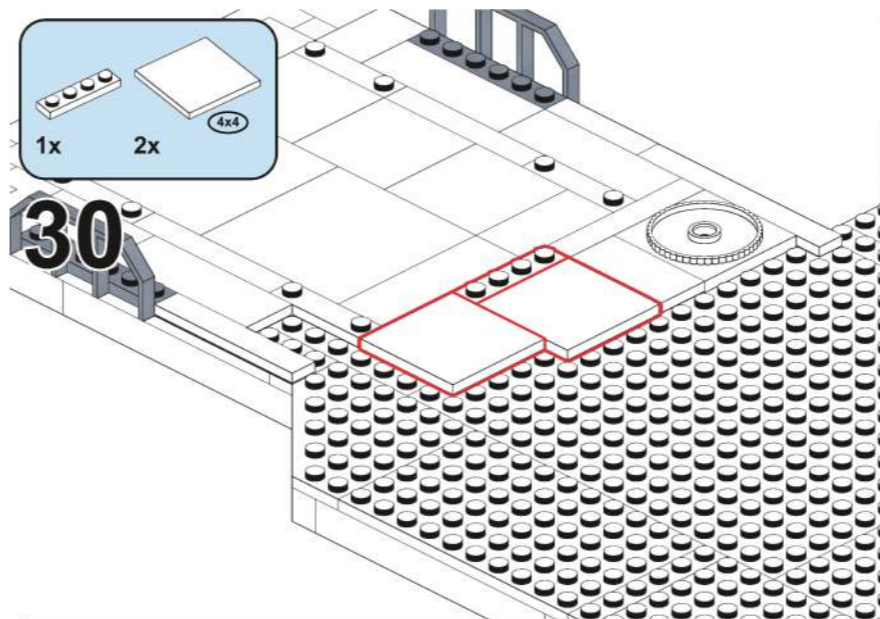

31

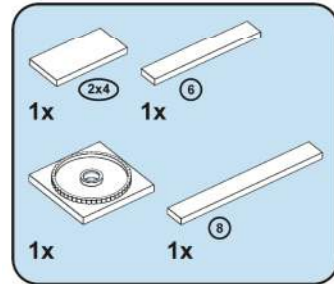
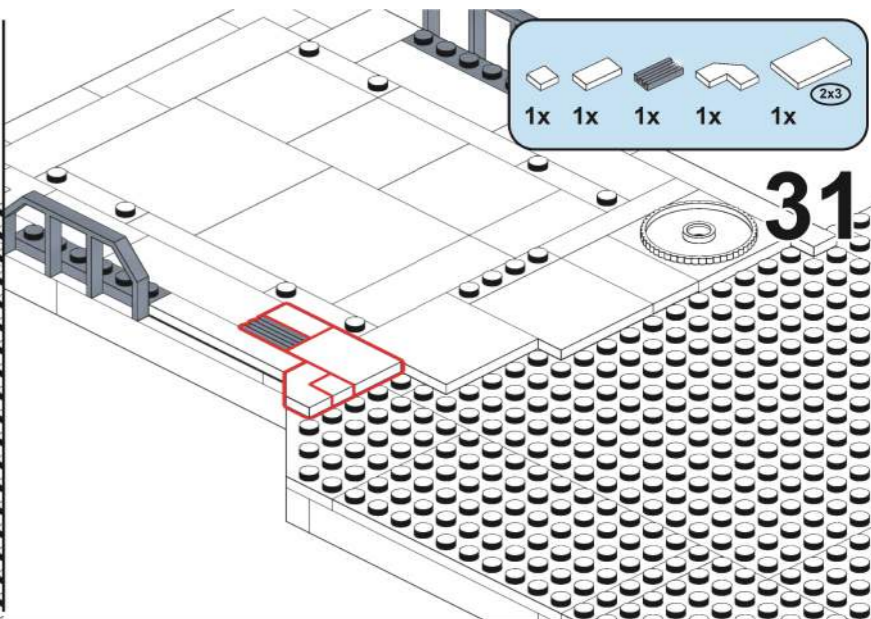

29

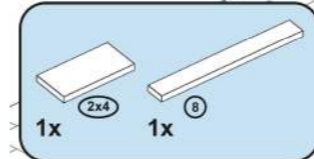
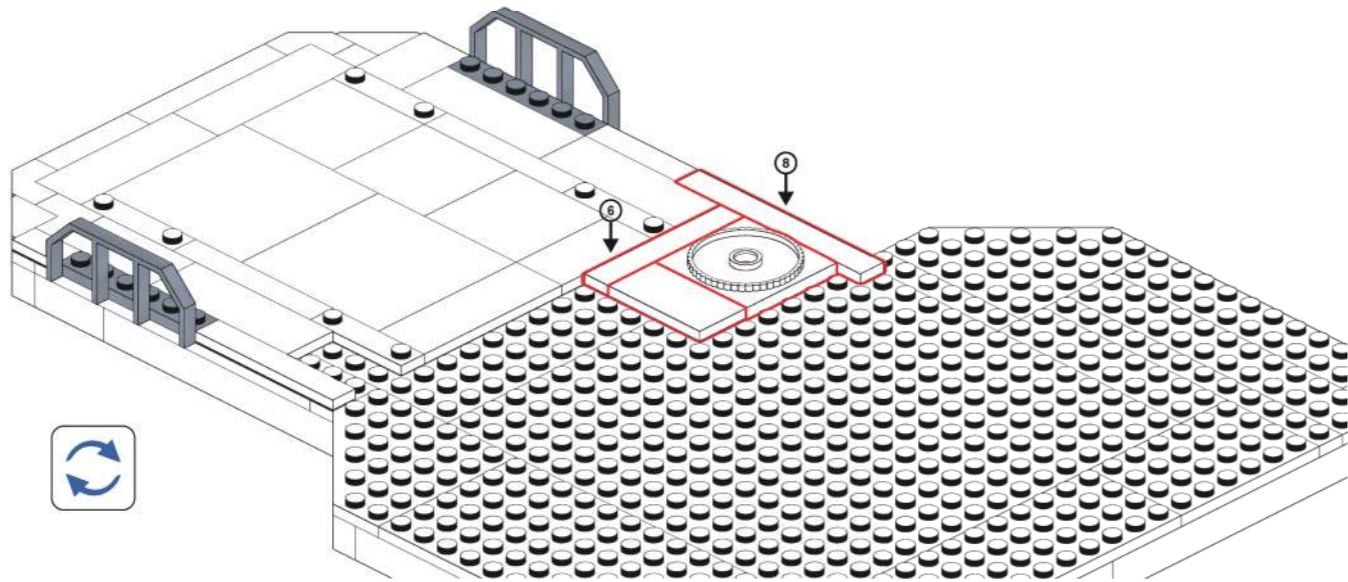

32

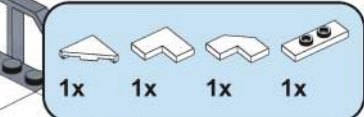
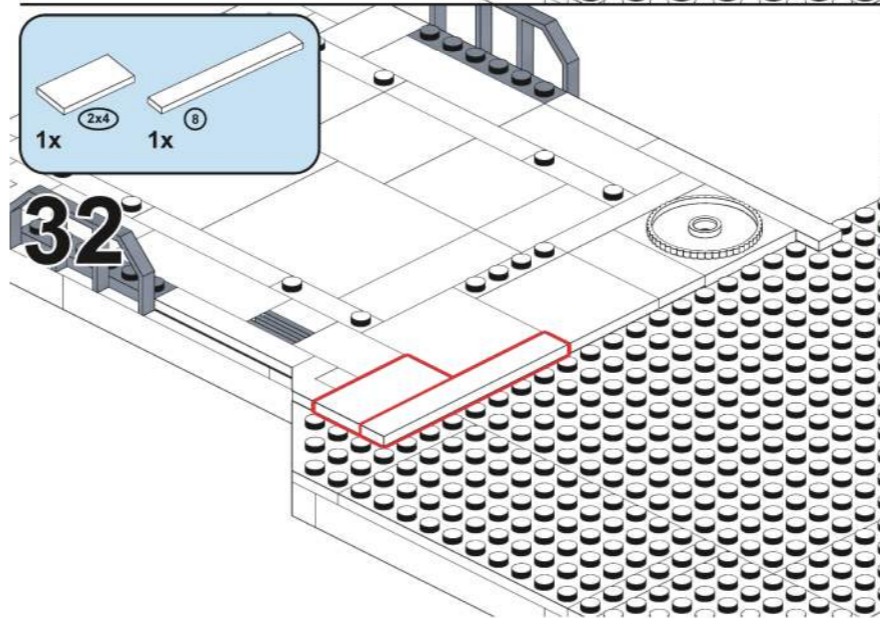

33

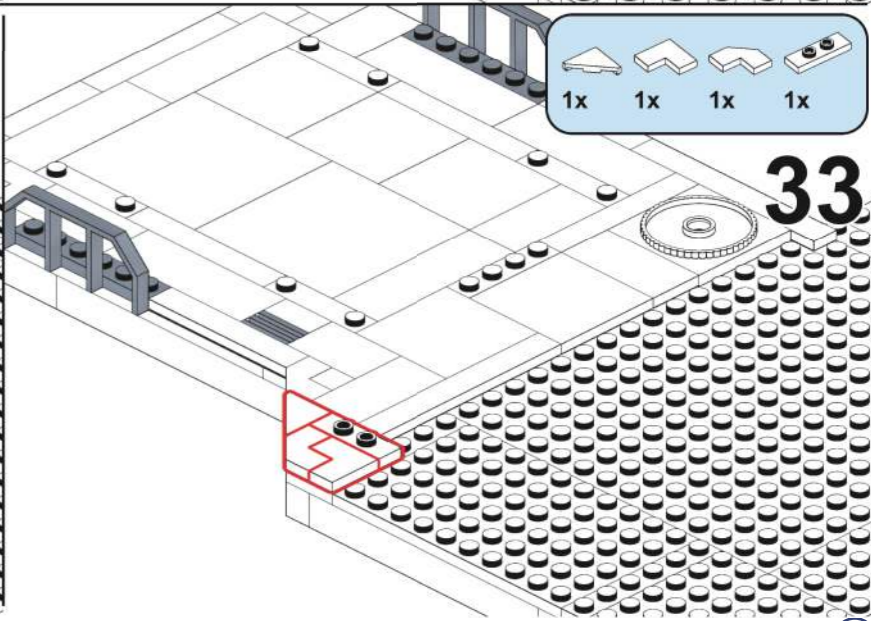

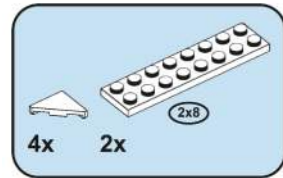

34

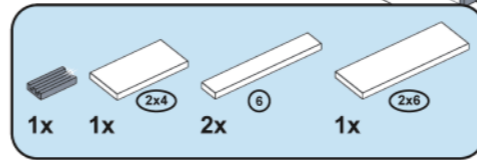
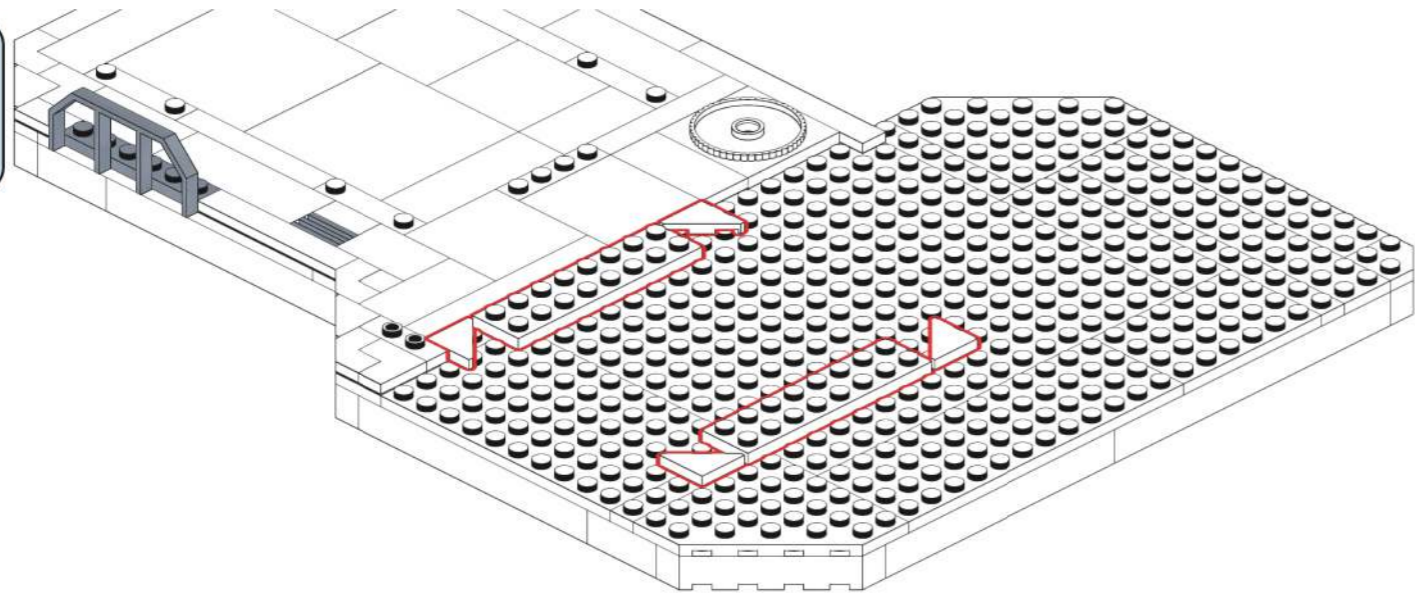

36

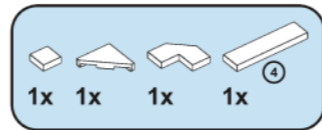
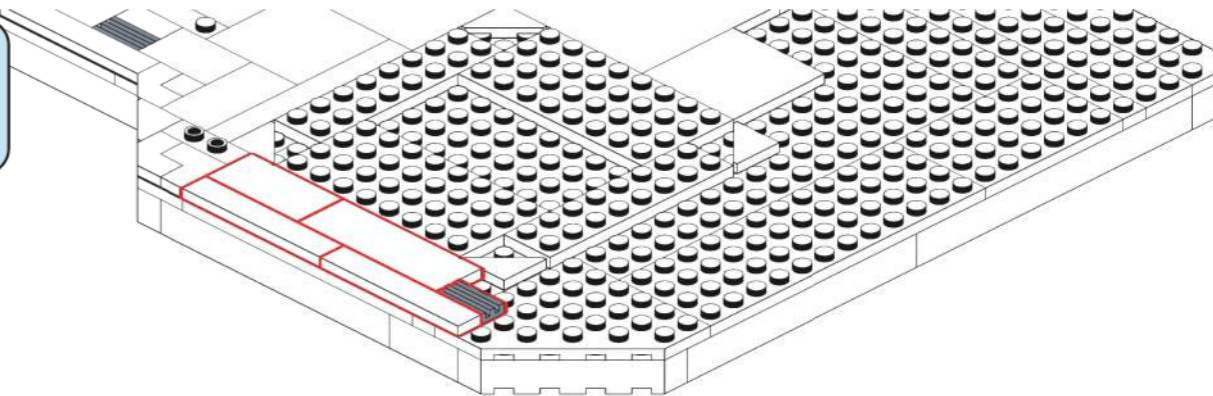

37

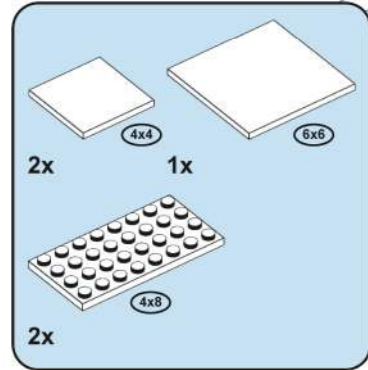
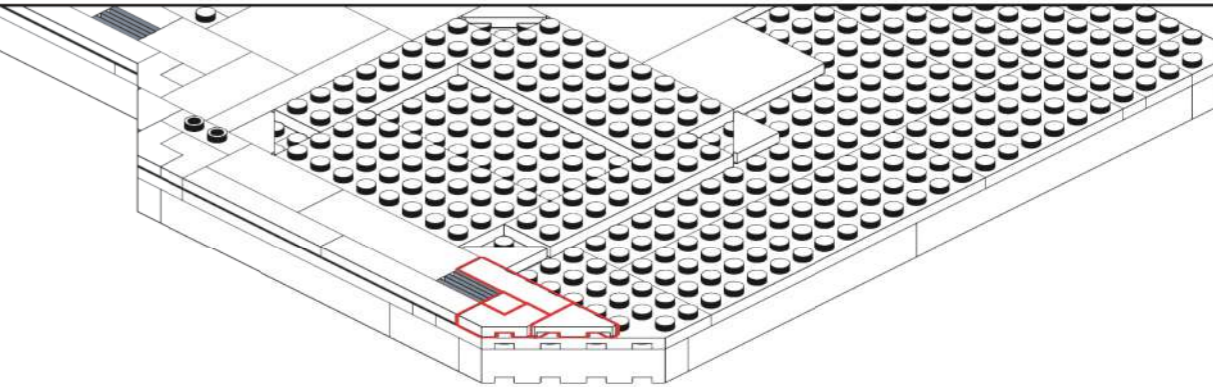

35

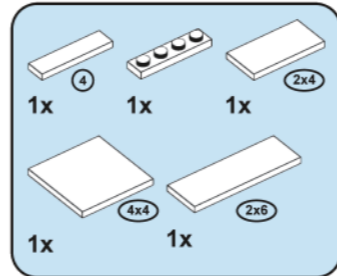
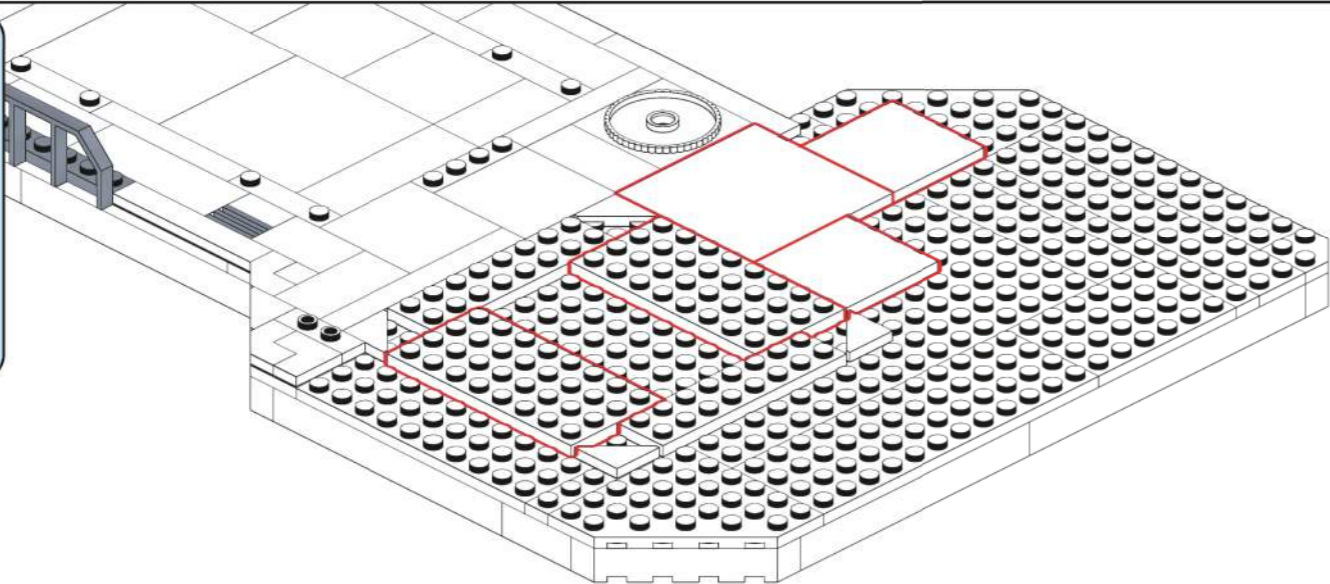

38

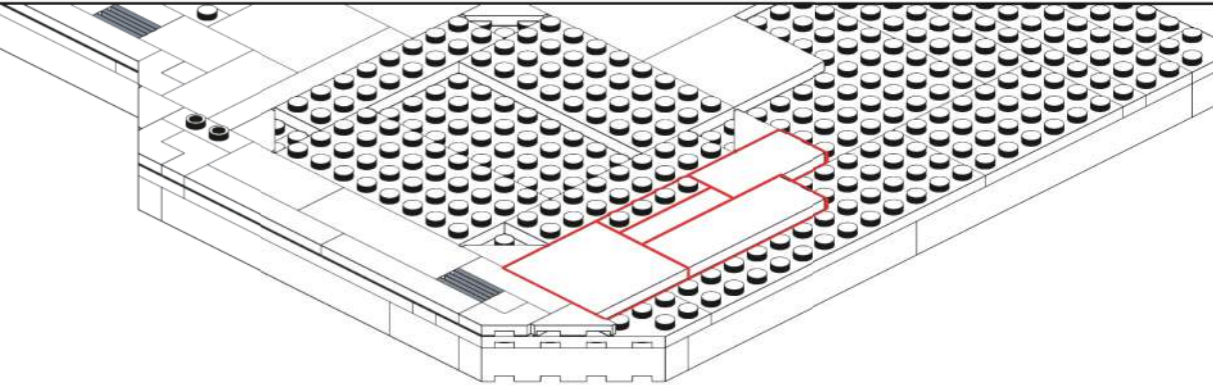

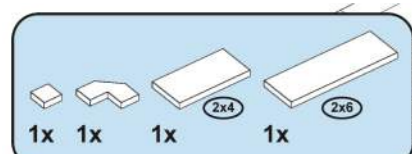

39

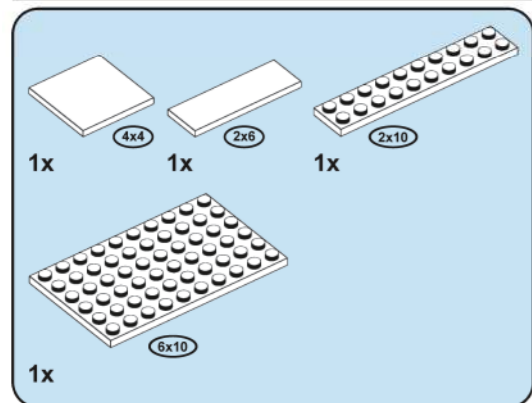
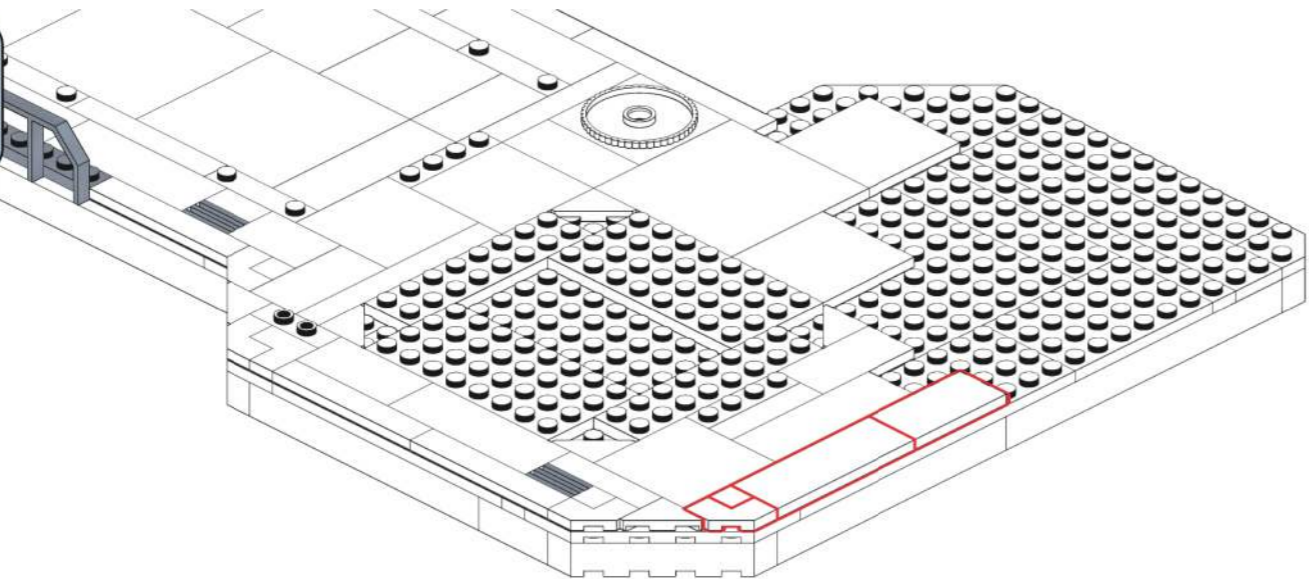

40

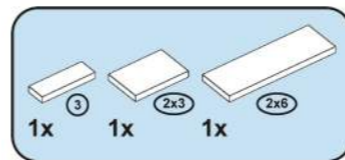
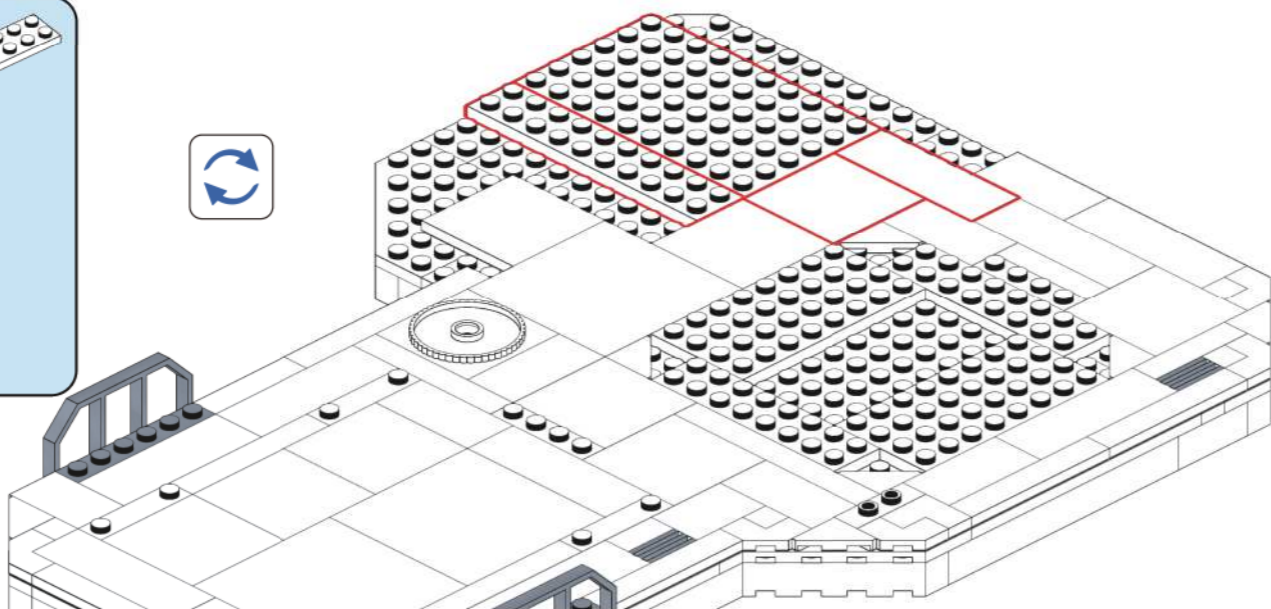

41

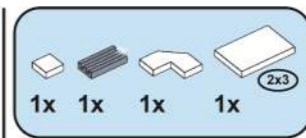
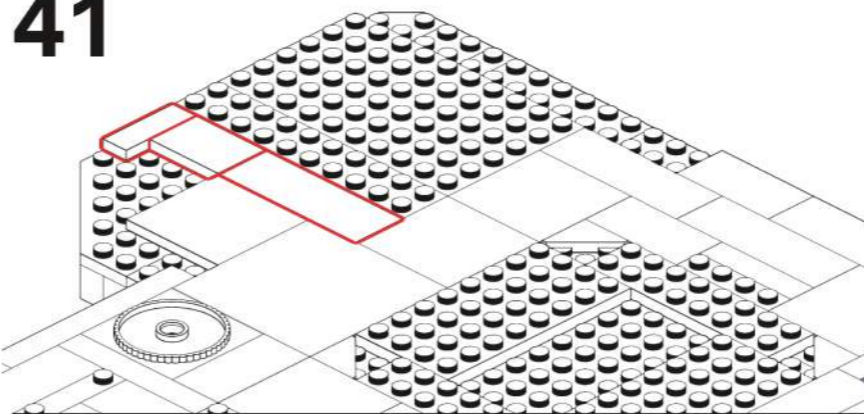

42

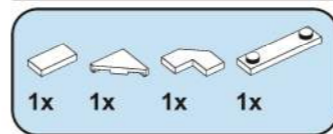
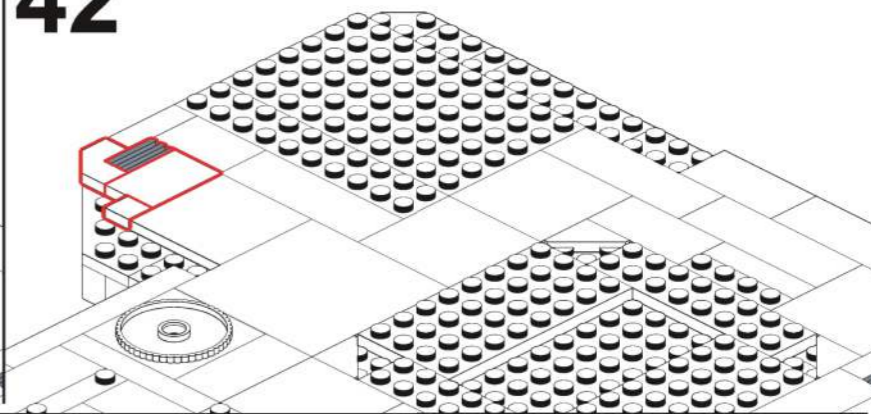

43

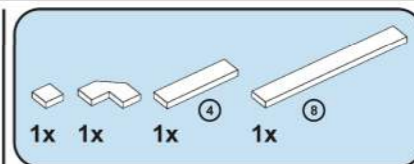
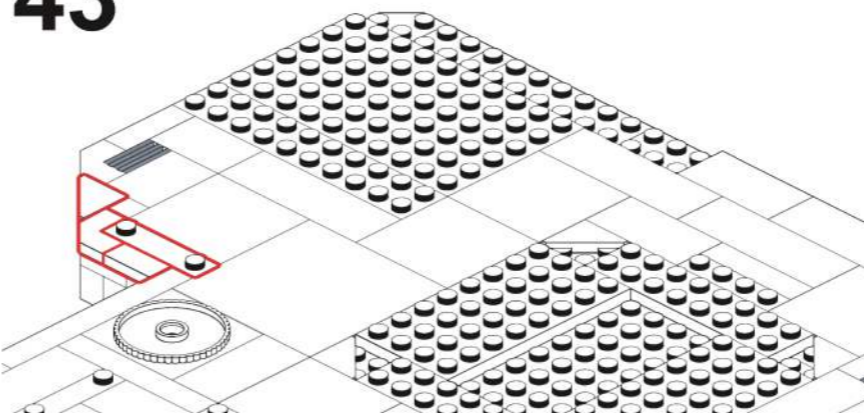

44

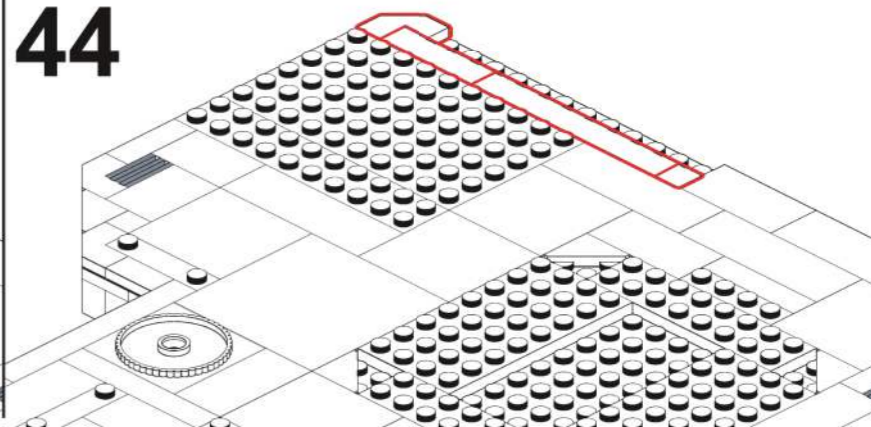

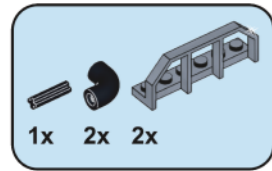

45

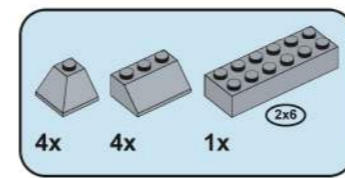
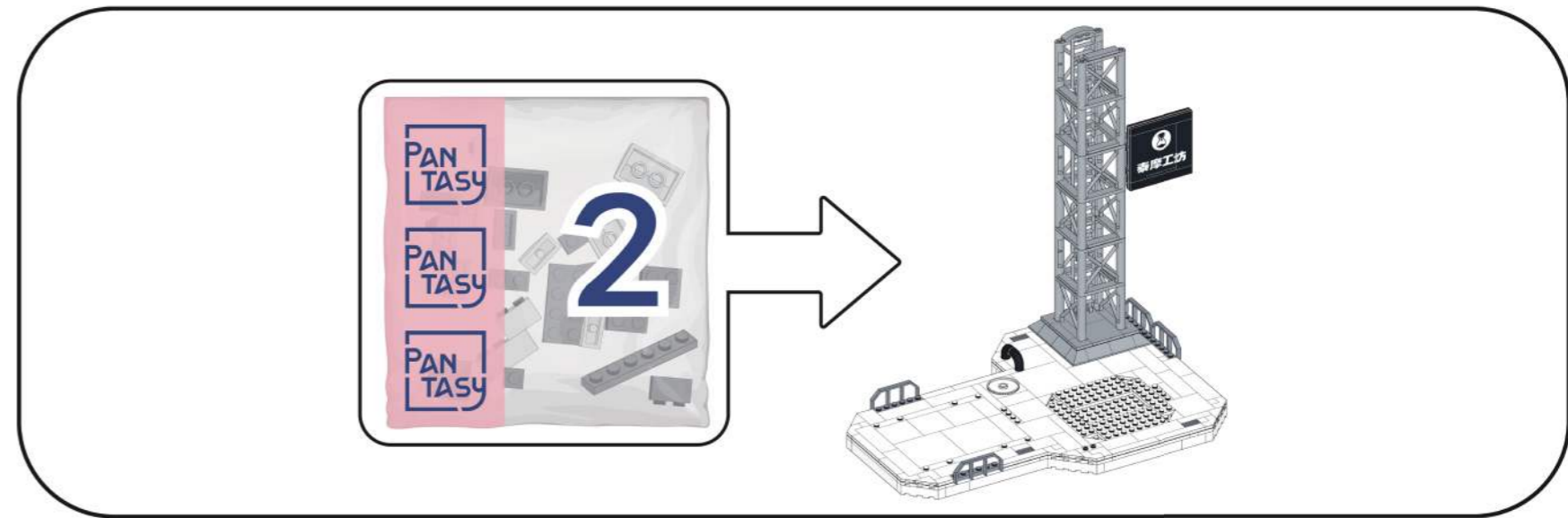
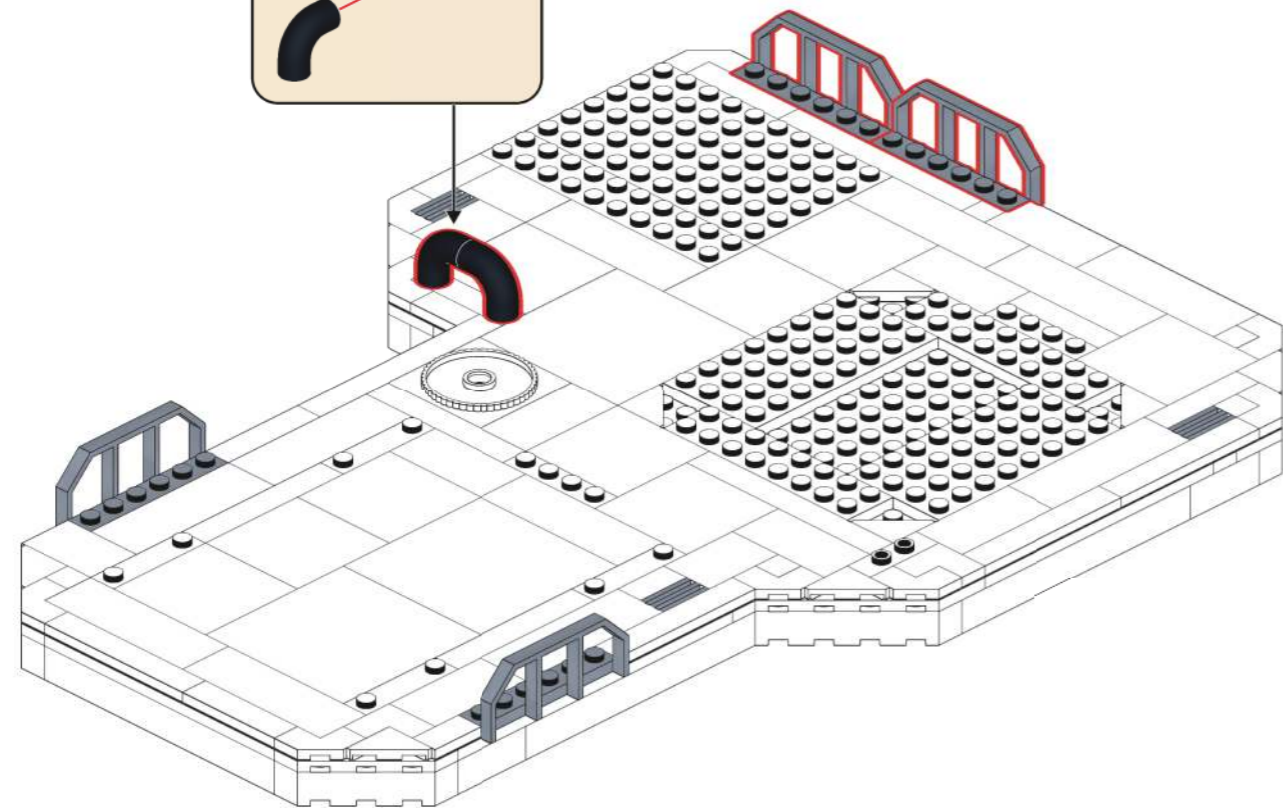
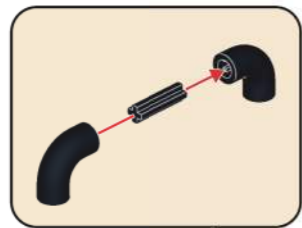

46

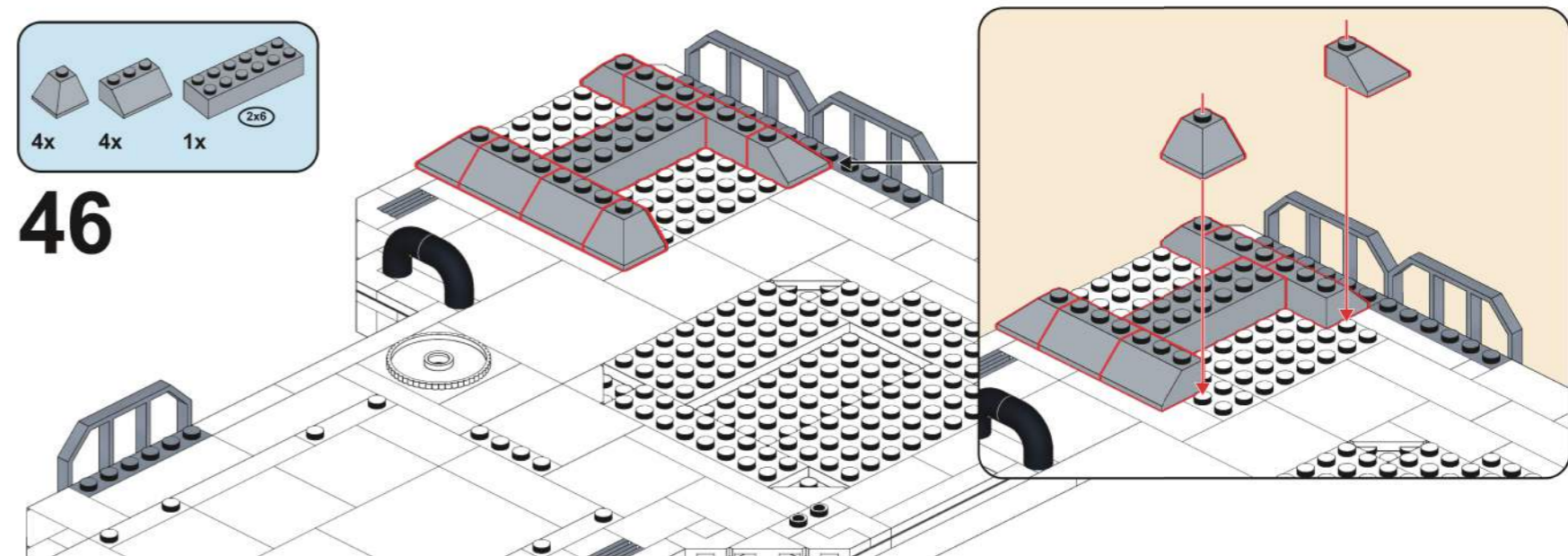

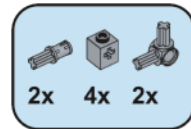

47

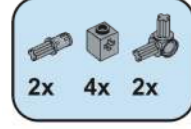
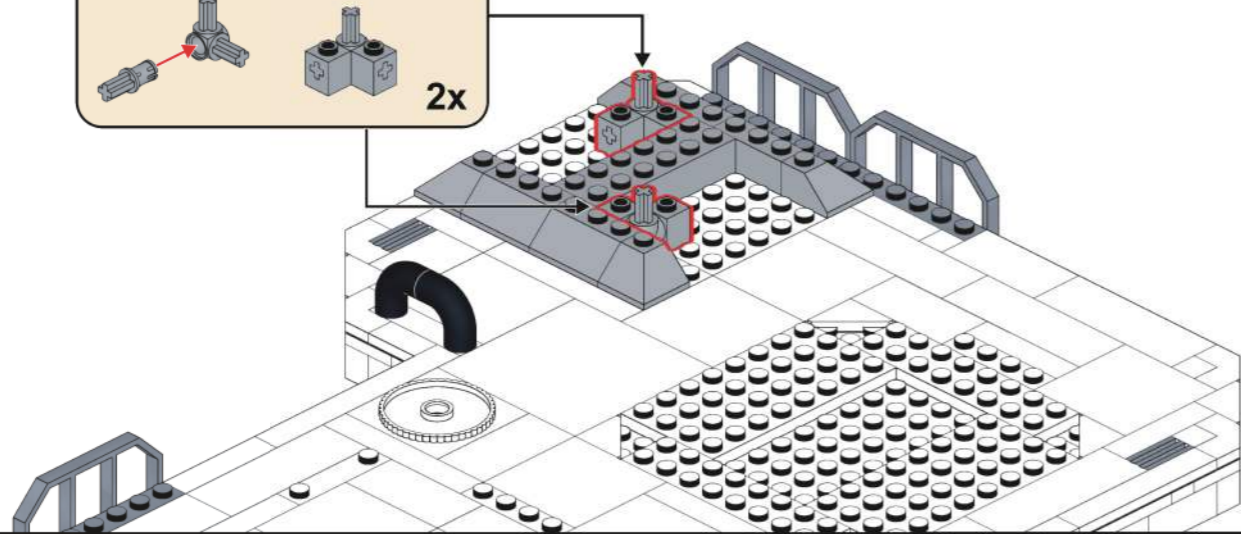
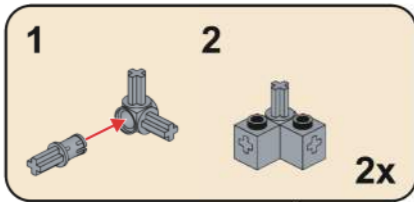

48

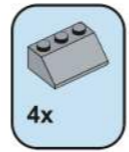
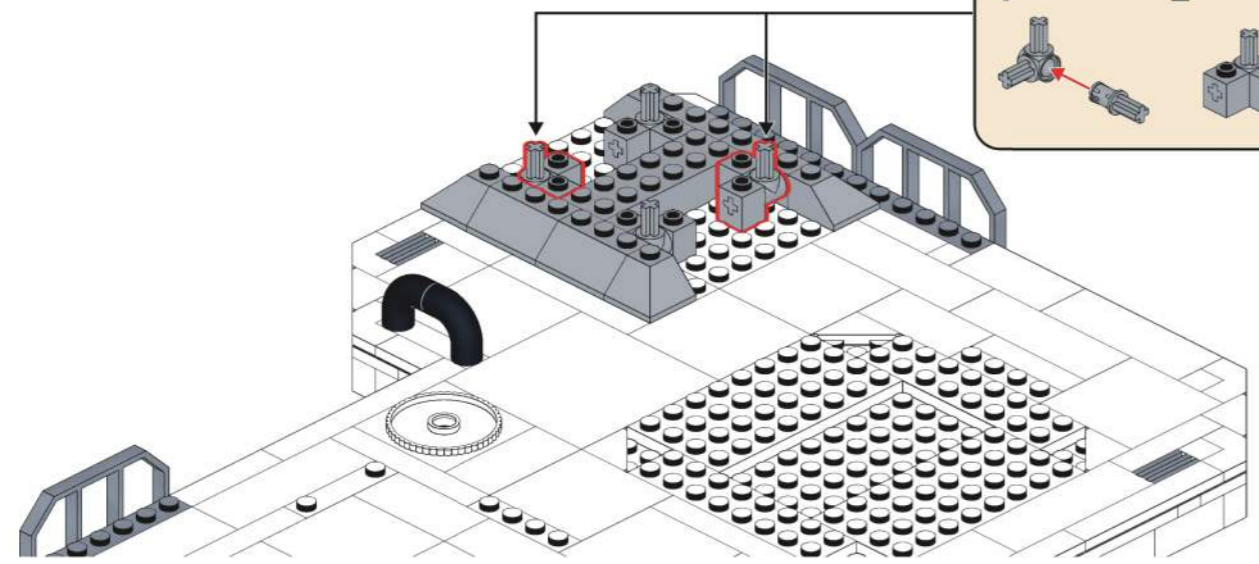
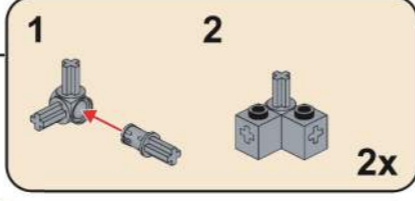

49

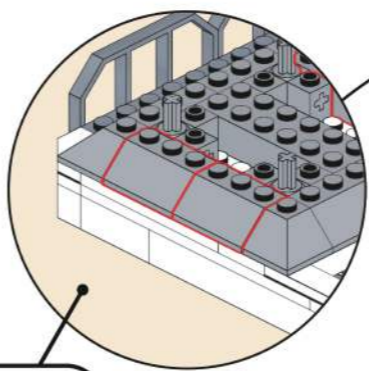

通过此视图可更清晰地观察拼装位置噢。

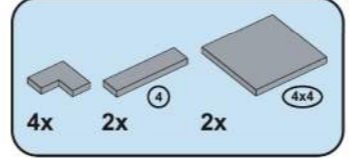
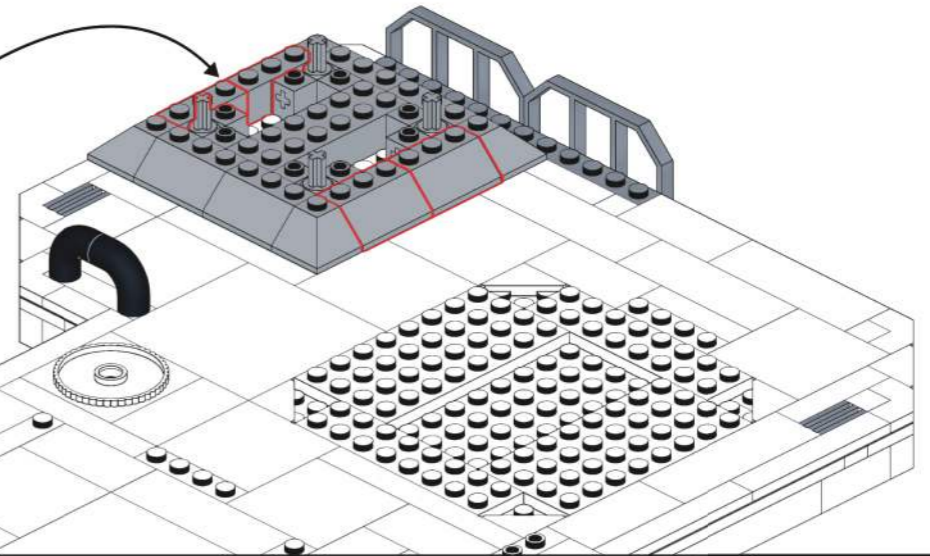

50

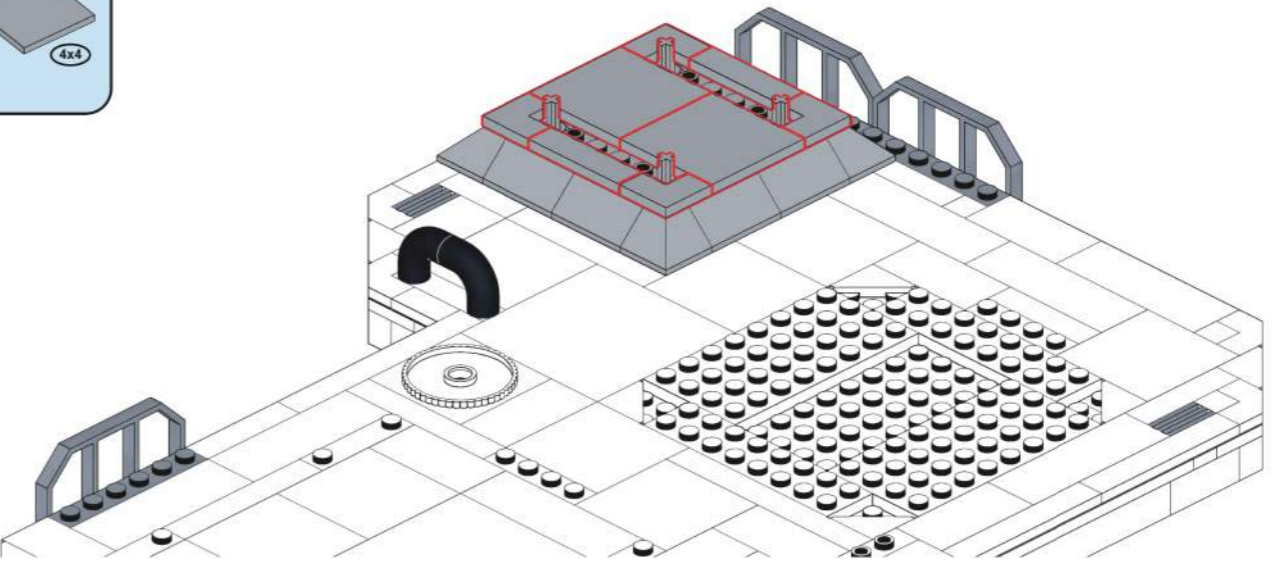

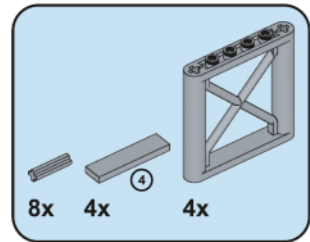

51

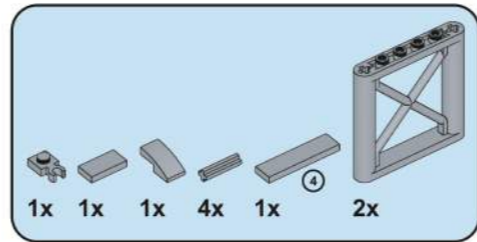
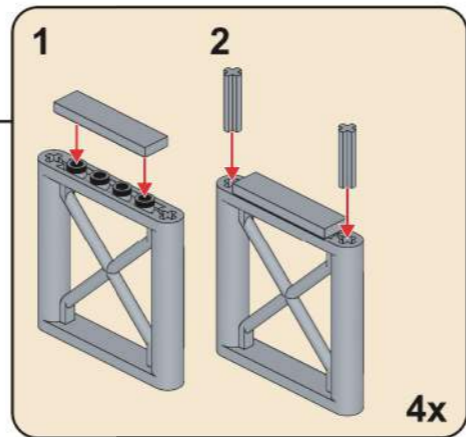
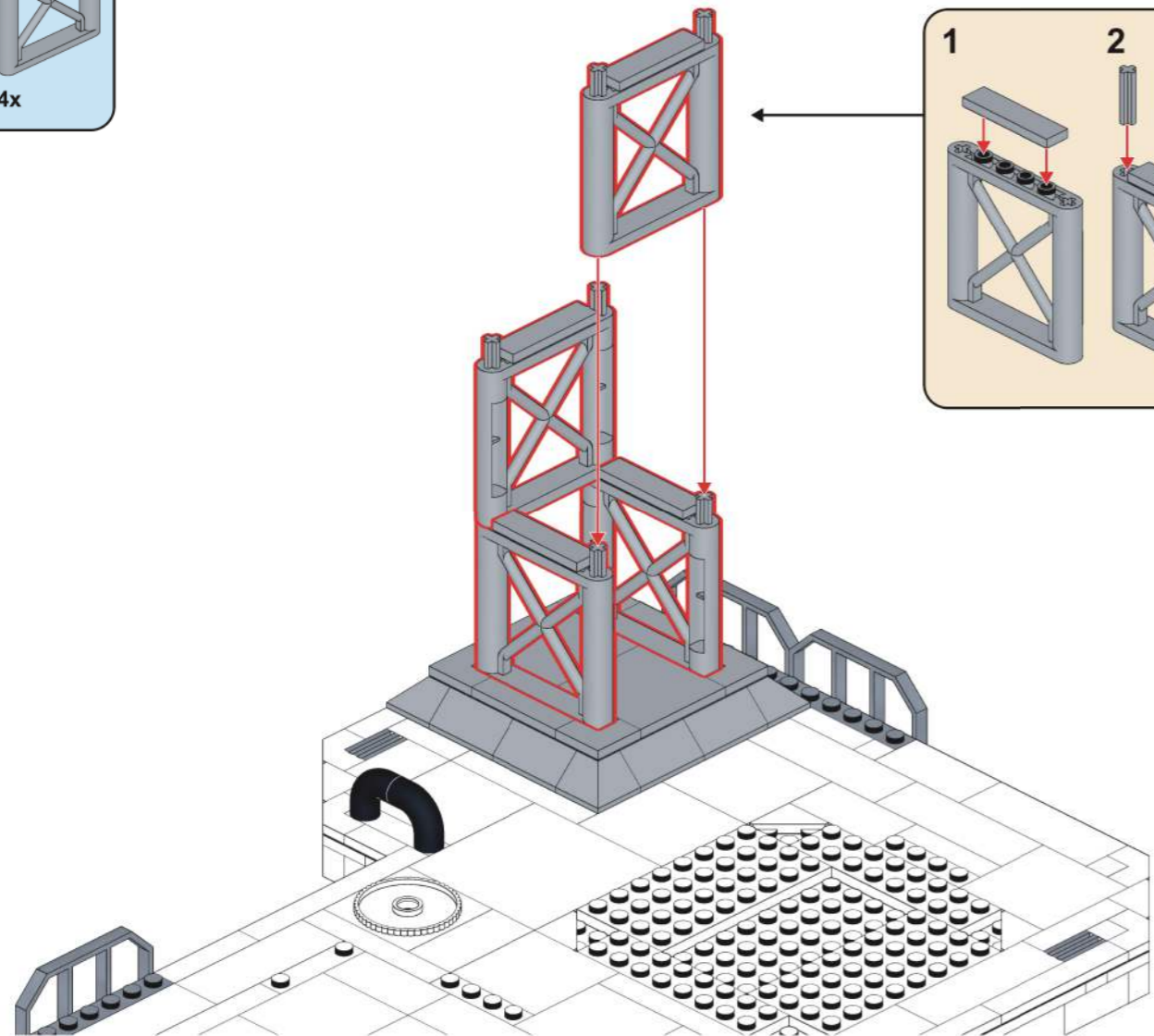

52

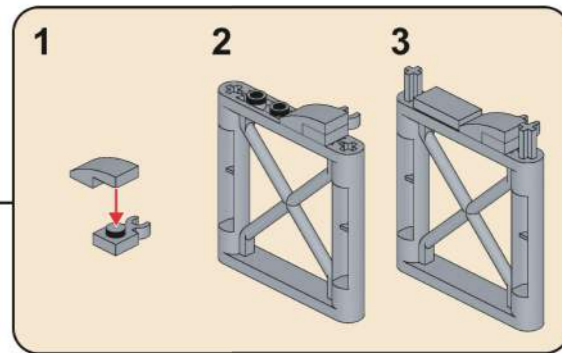
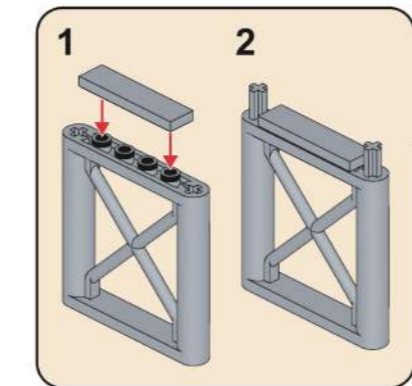

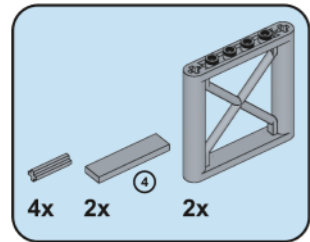

53

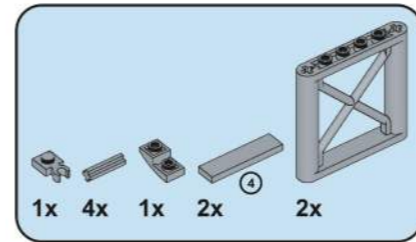
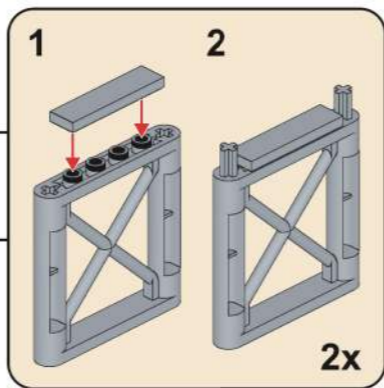
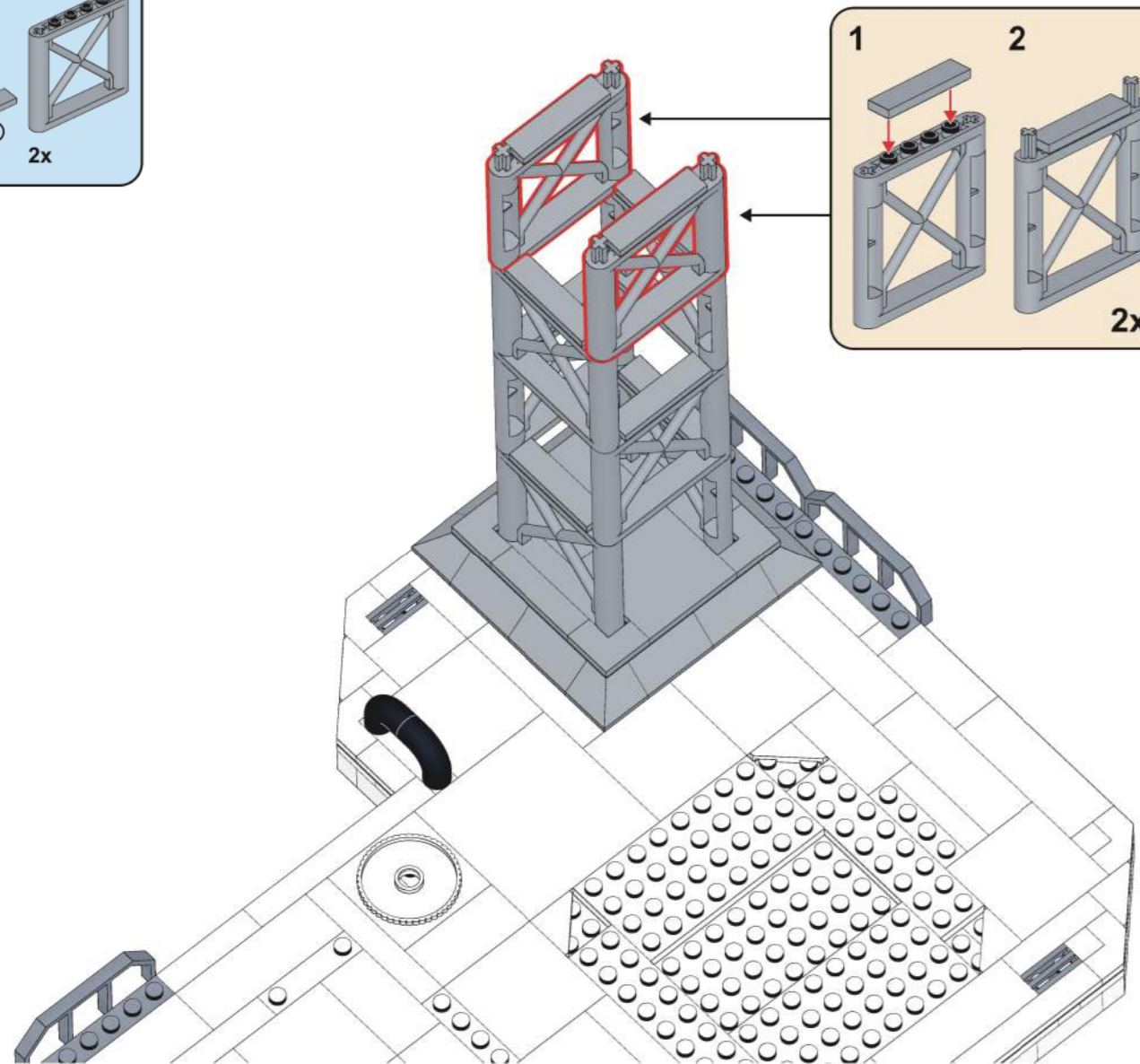

54

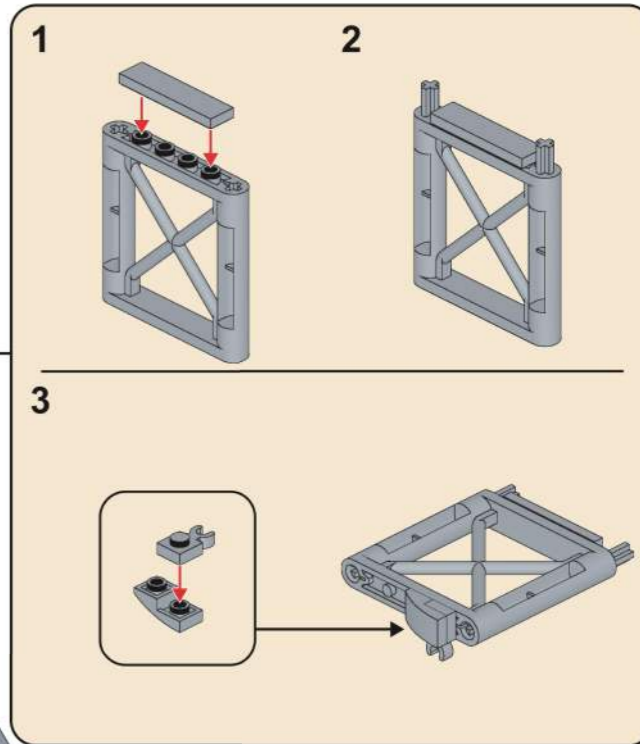
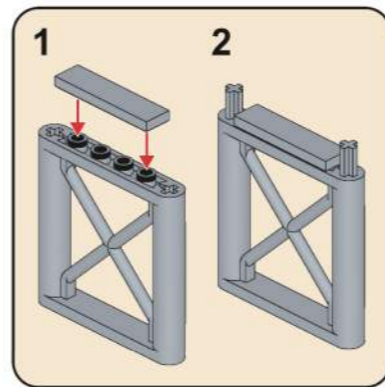
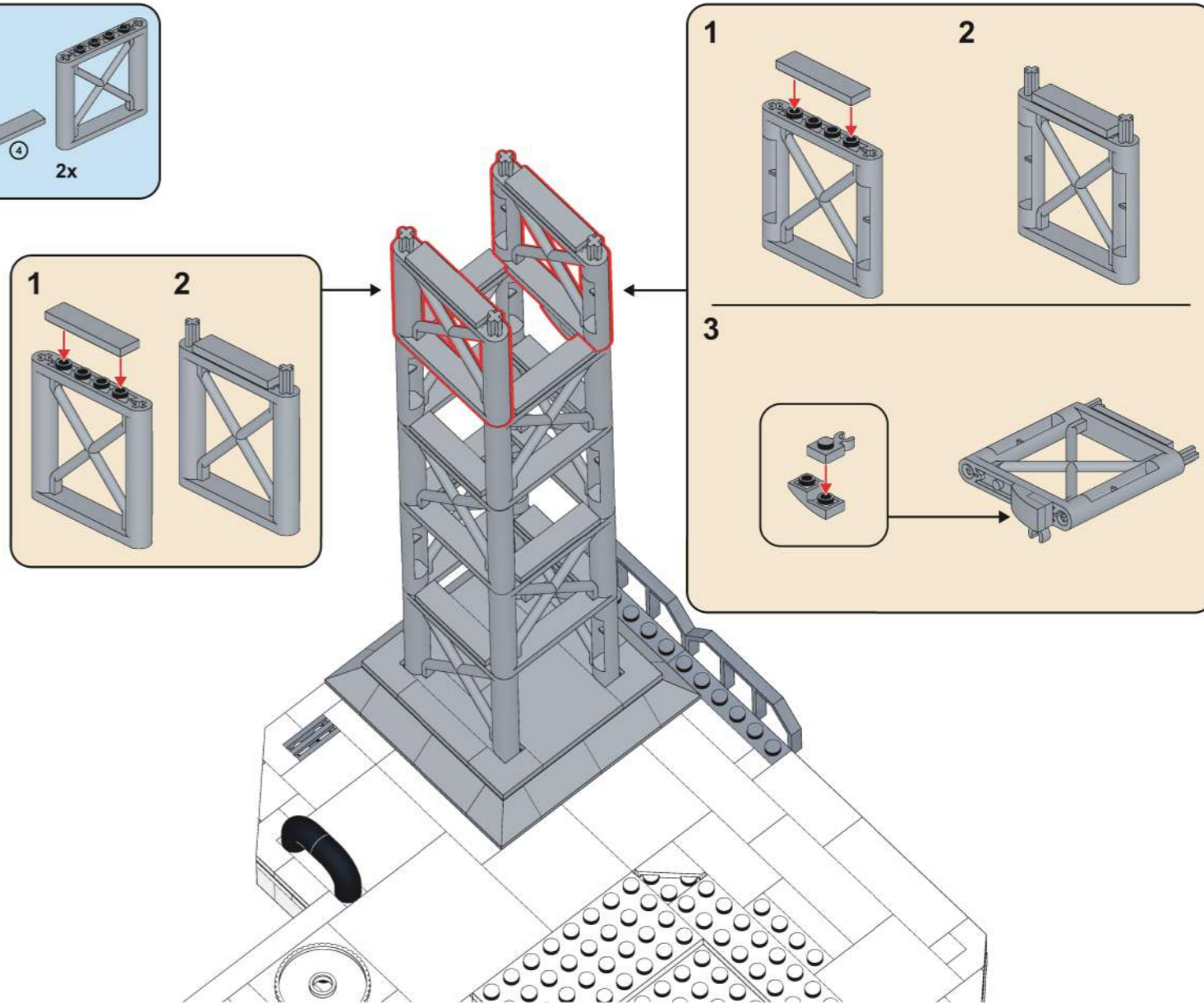

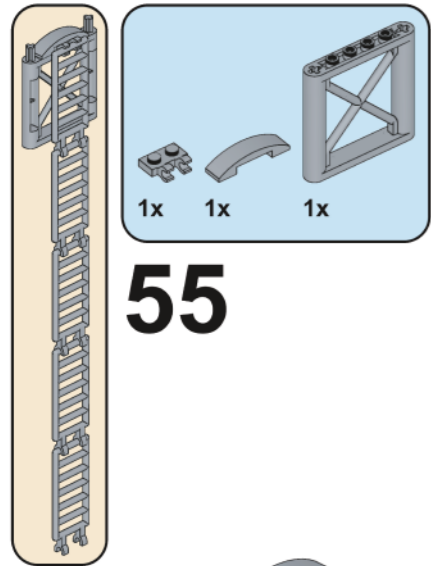

55

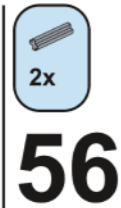
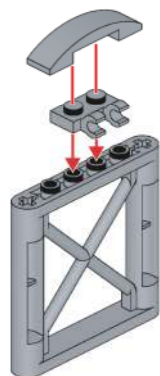

56

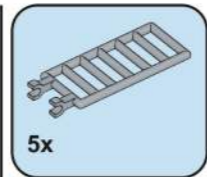
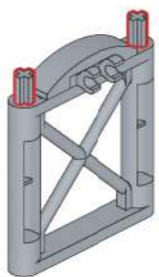

57

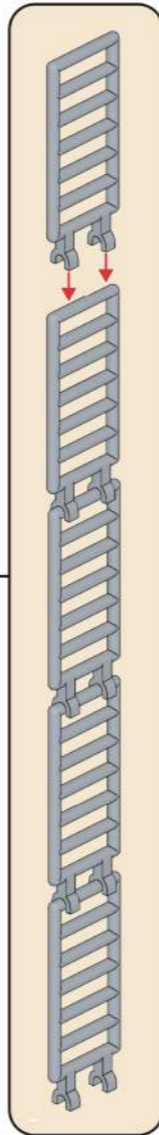
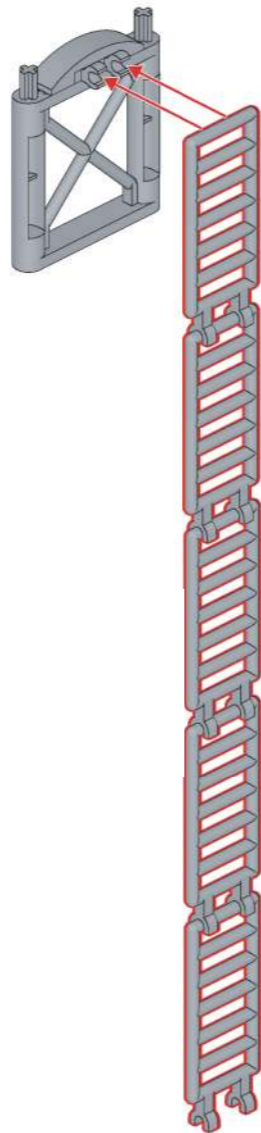

58

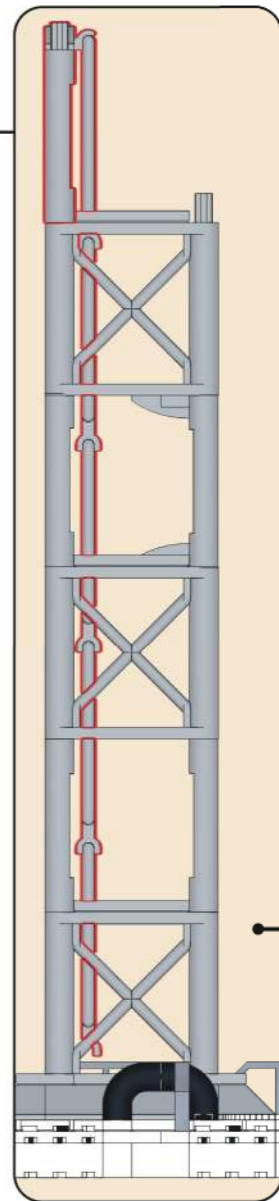
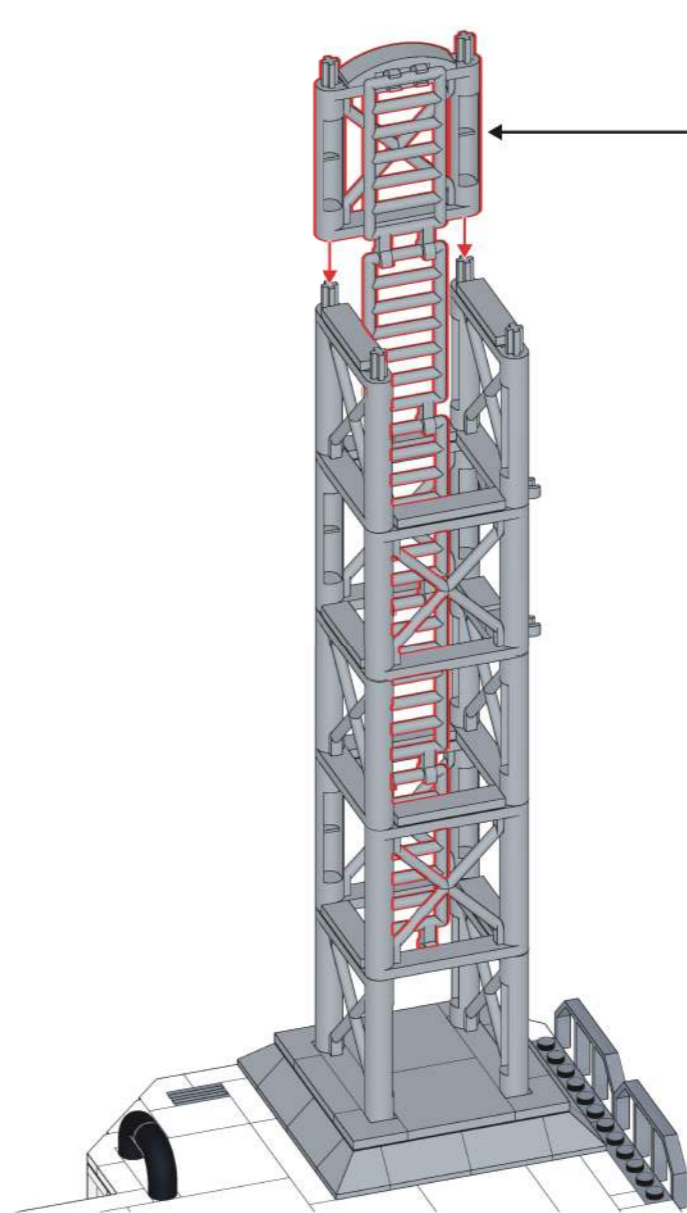

图示为侧视图。

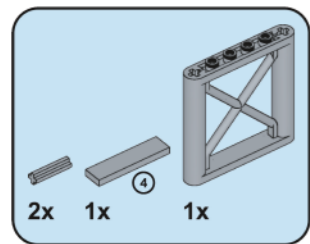

59

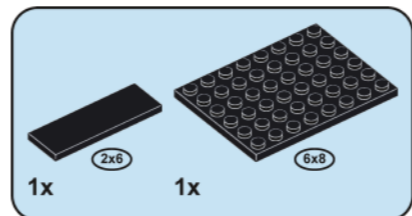
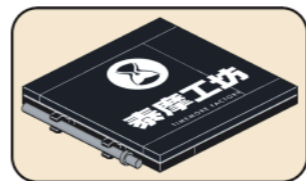
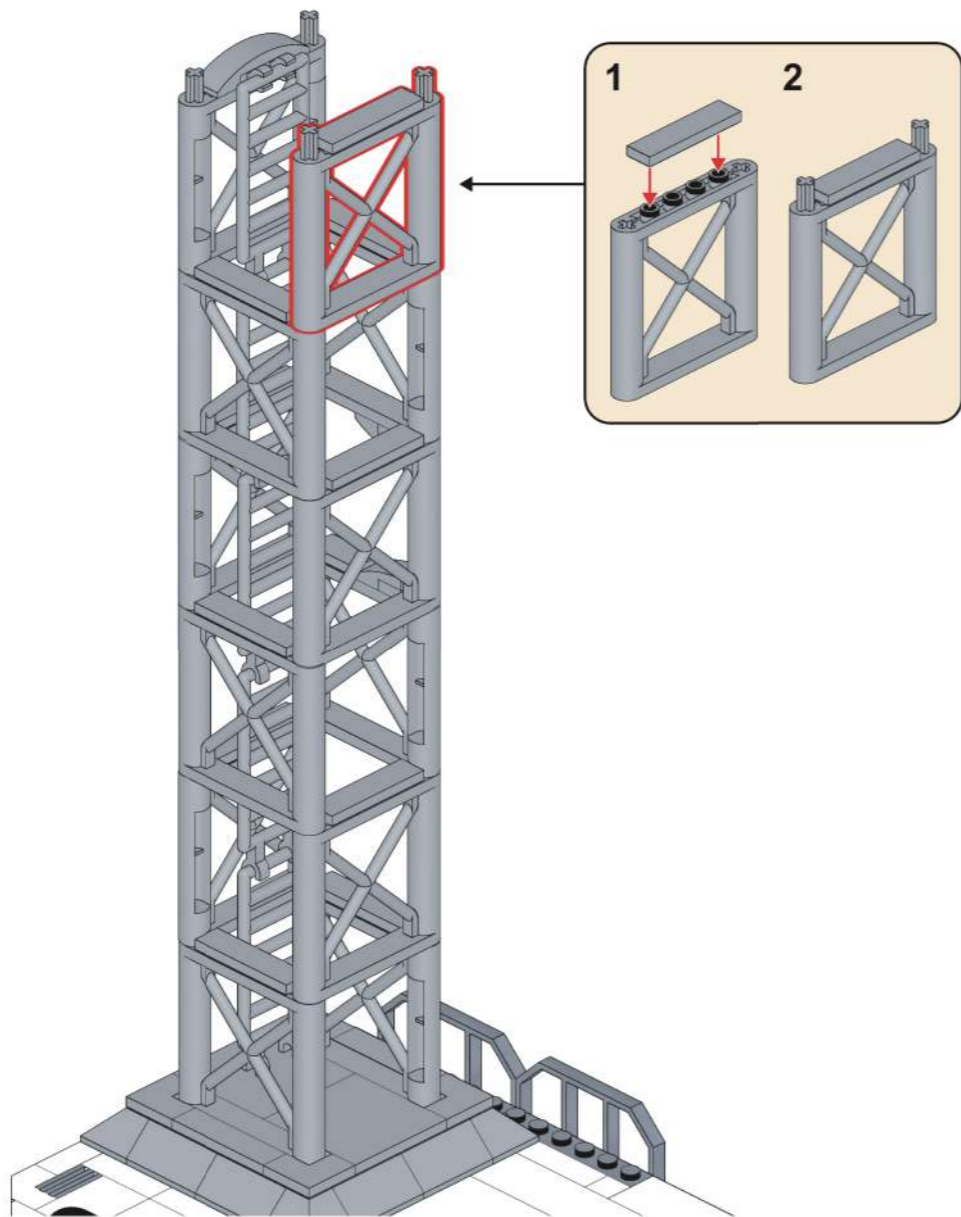

60

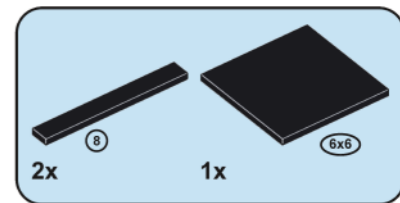

61

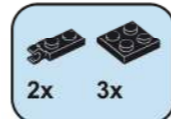
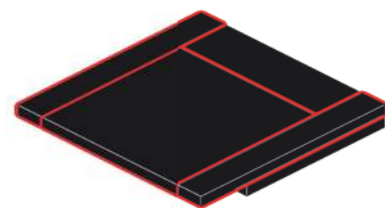

62

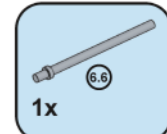
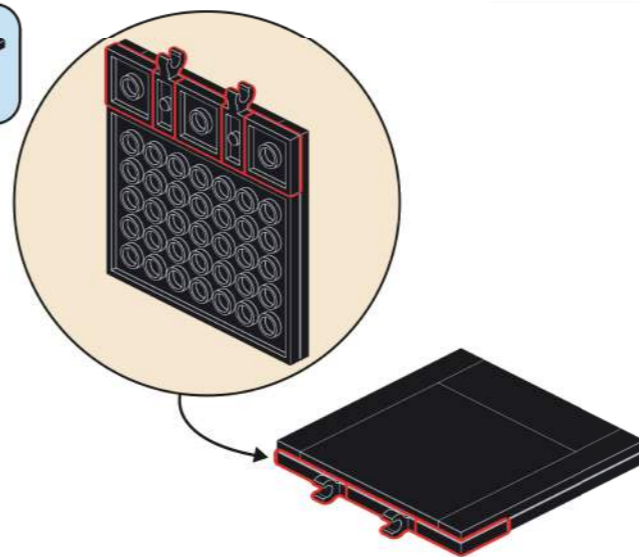

63

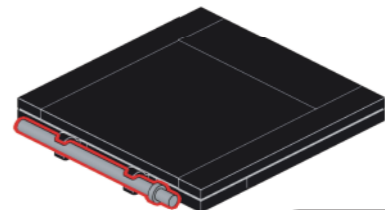

这是1:1零件比例尺, 可以用来比对零件长度。



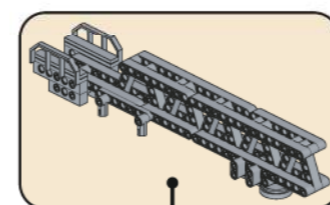
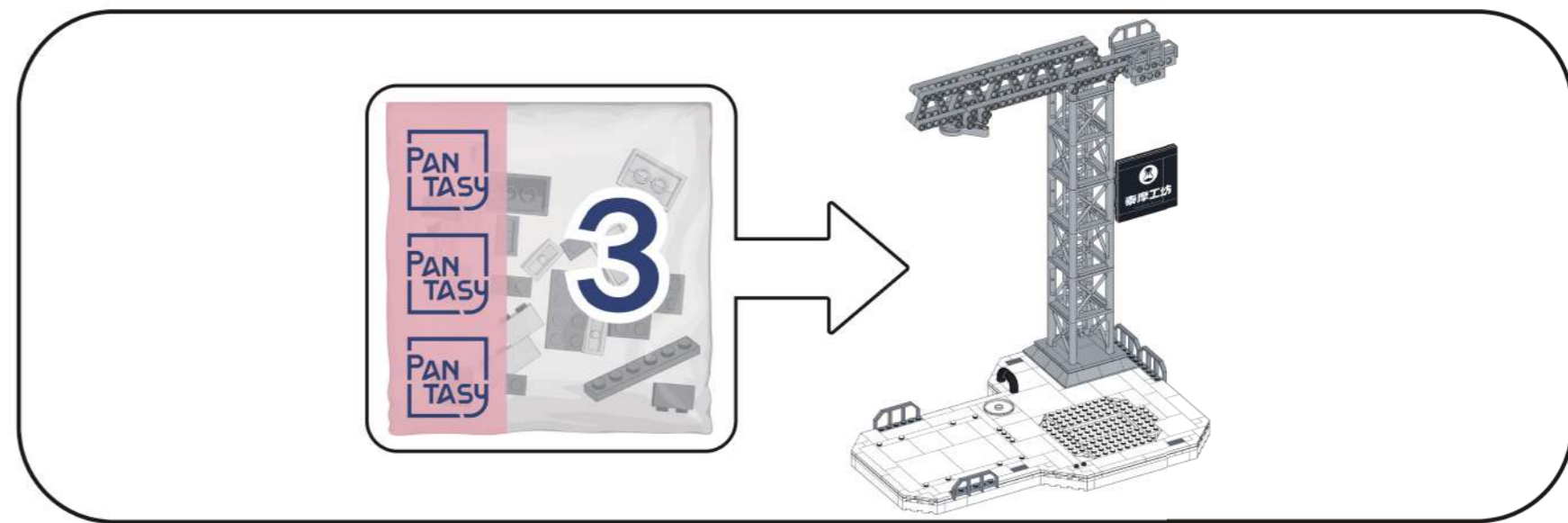
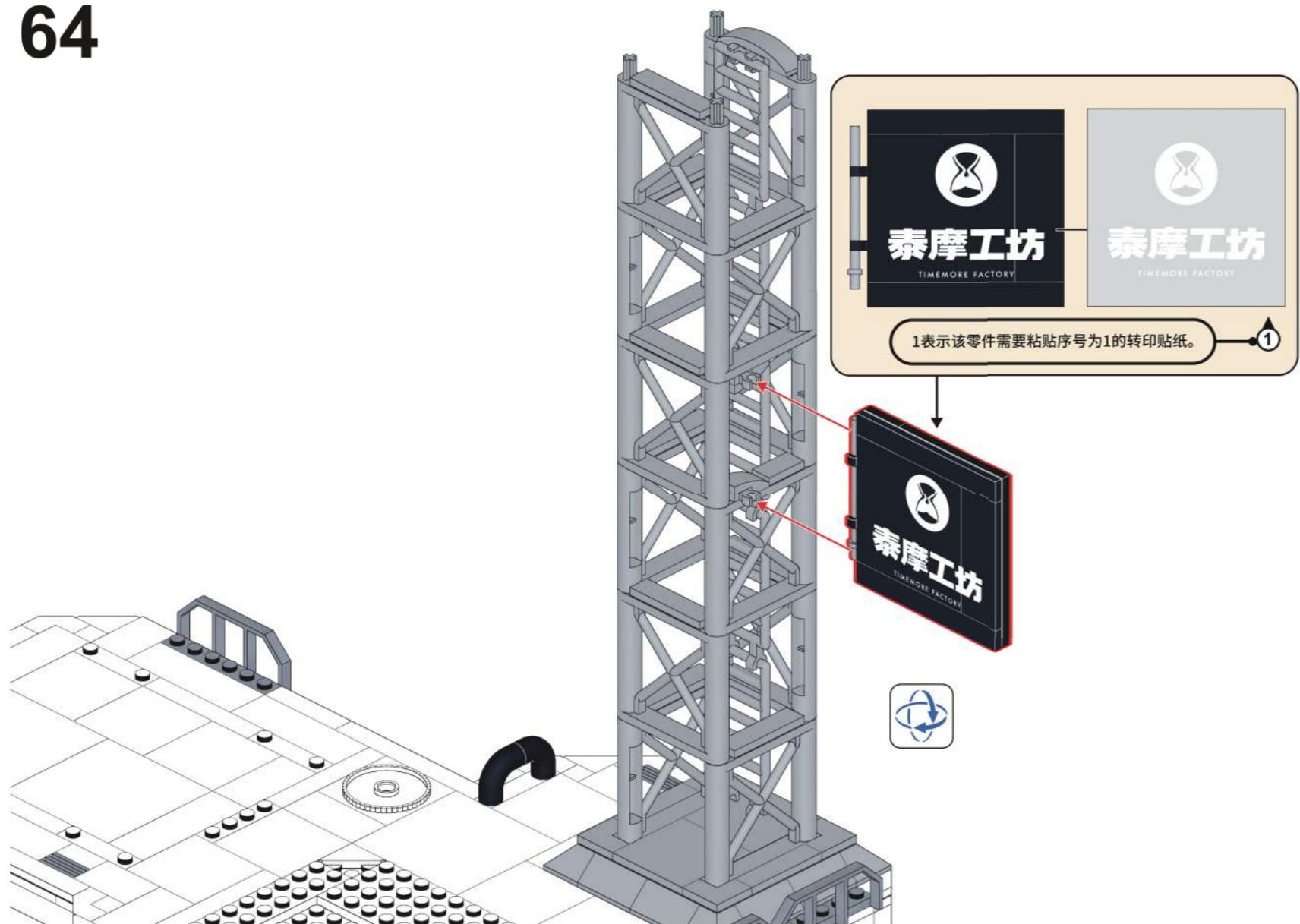

这是即将要拼搭的模块。

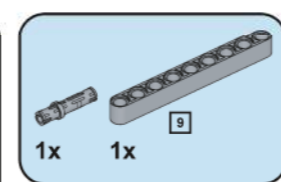

65



66

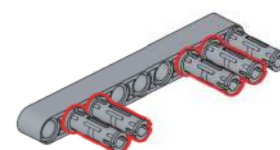

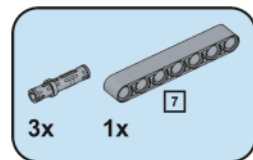

67

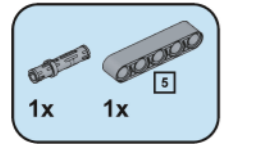
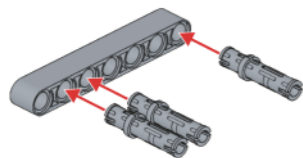

69

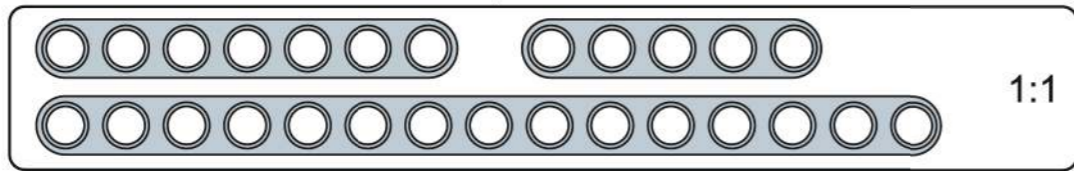
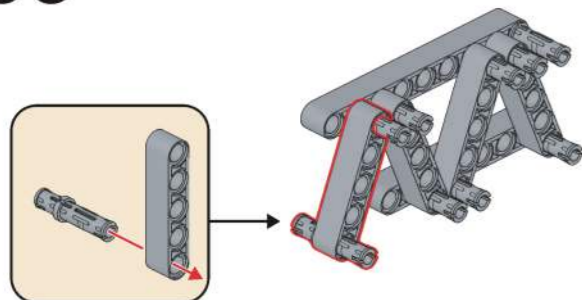

68

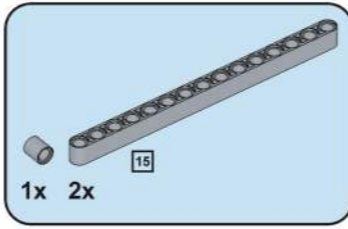
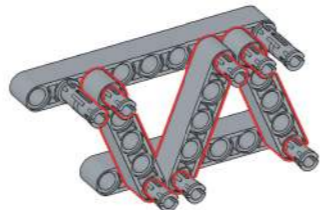

70

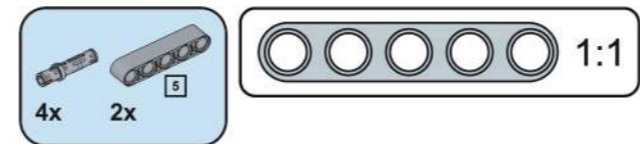
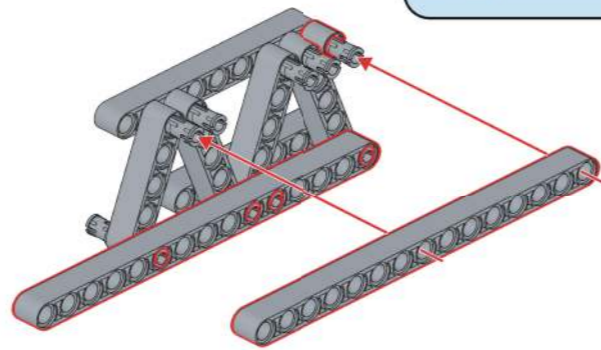

71

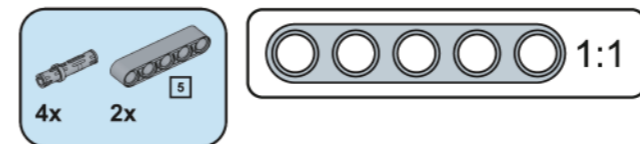
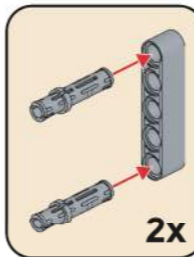
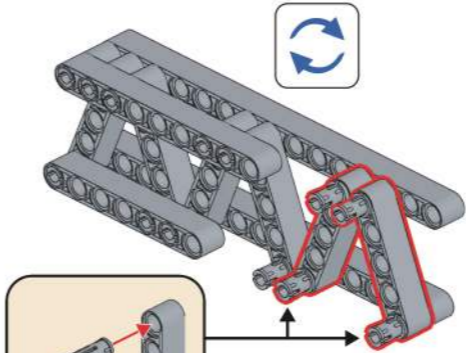

73

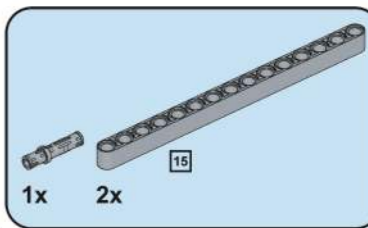
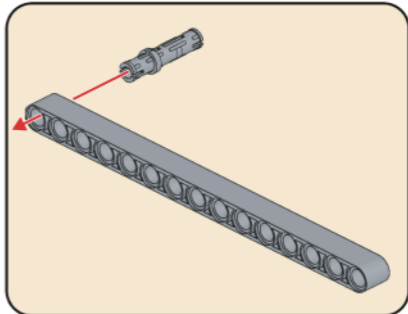
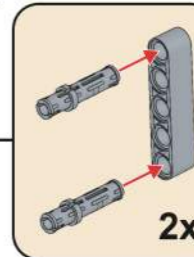
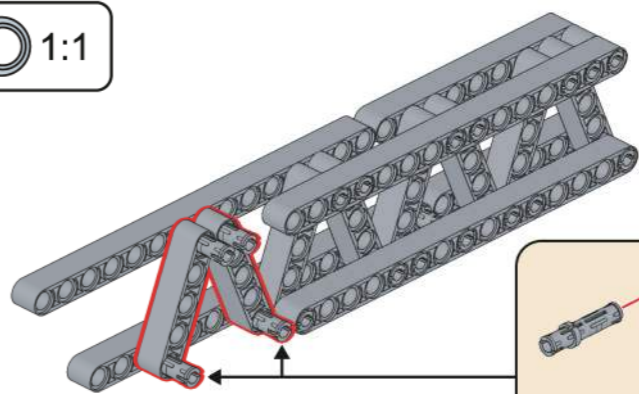

72

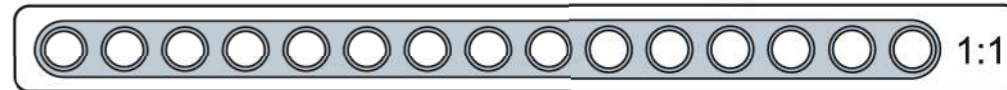
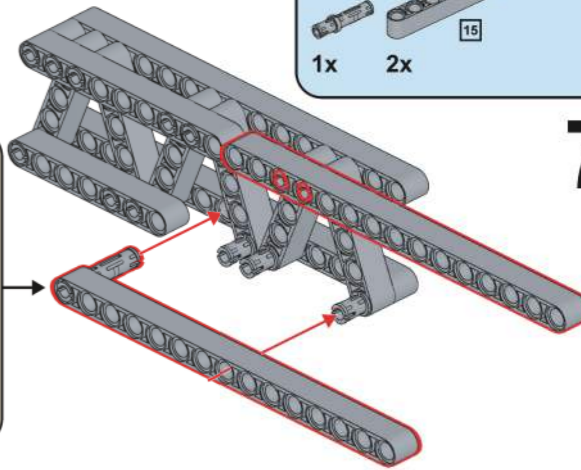

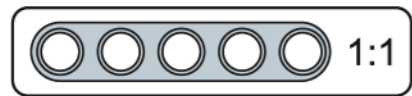
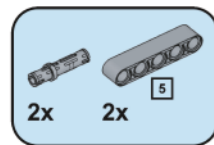

74

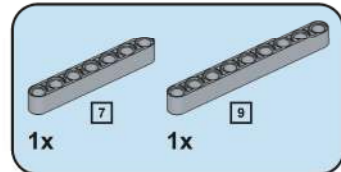
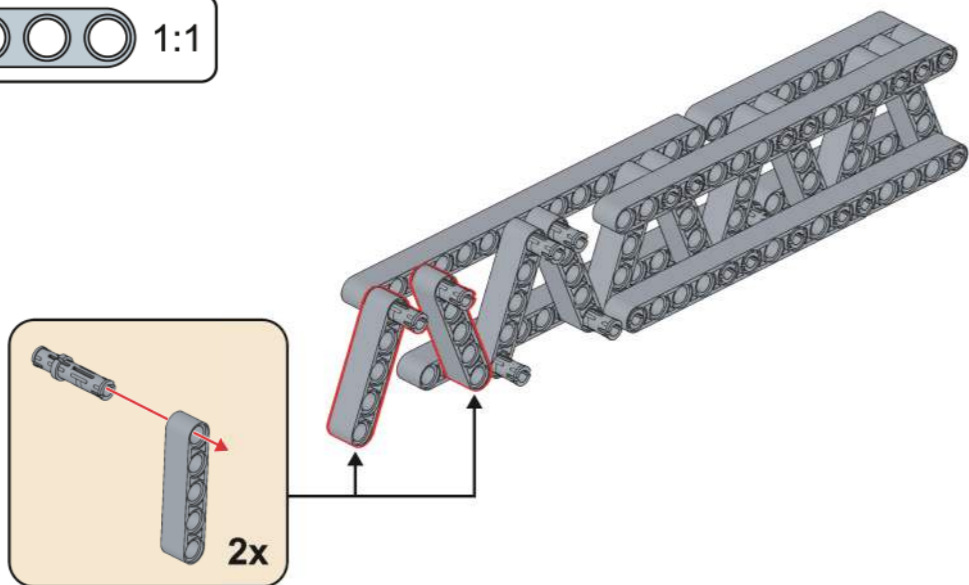

75

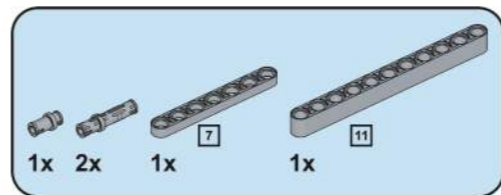
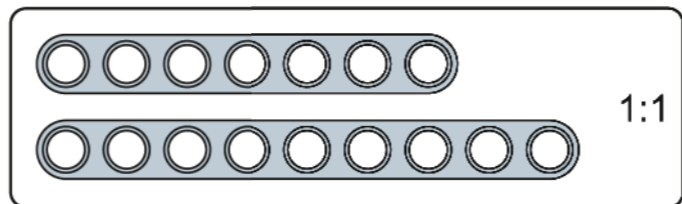
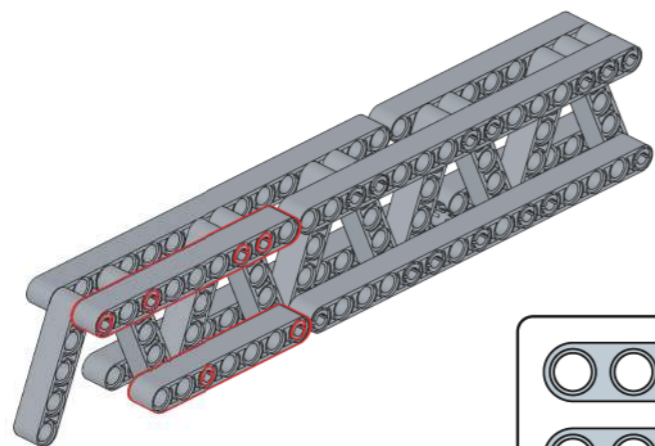

76

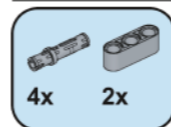
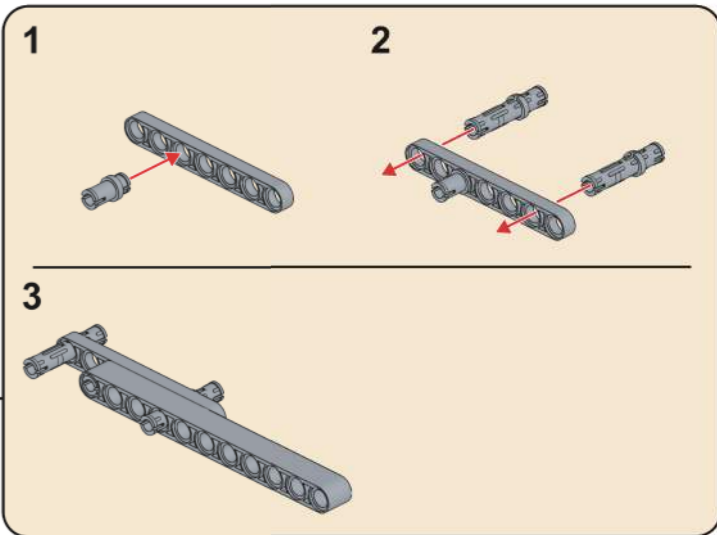
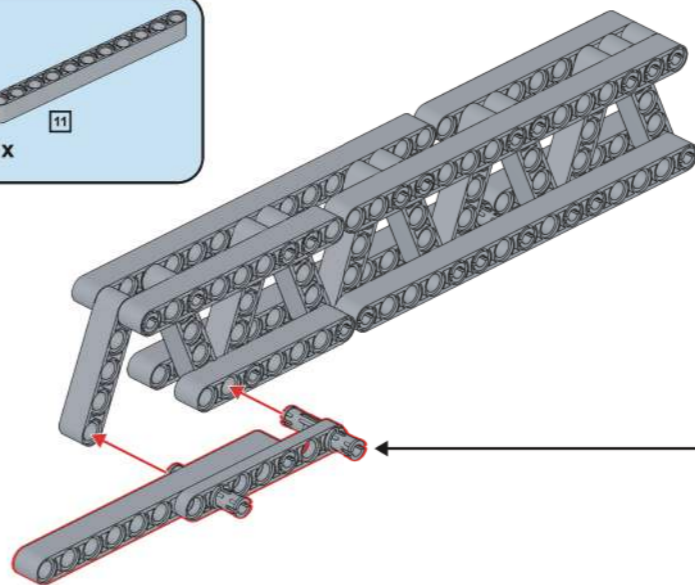

77

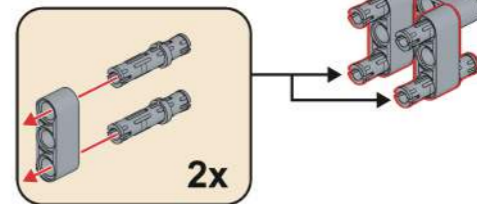
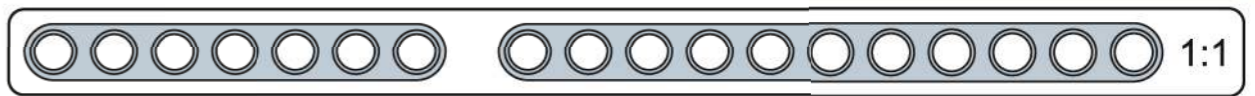

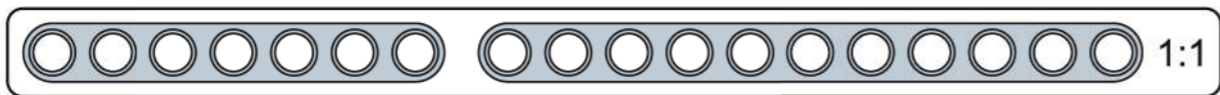
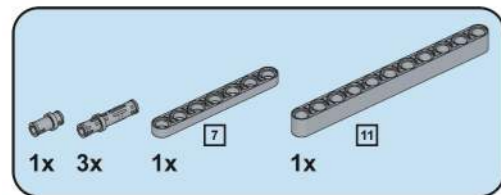

78

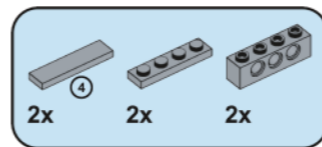
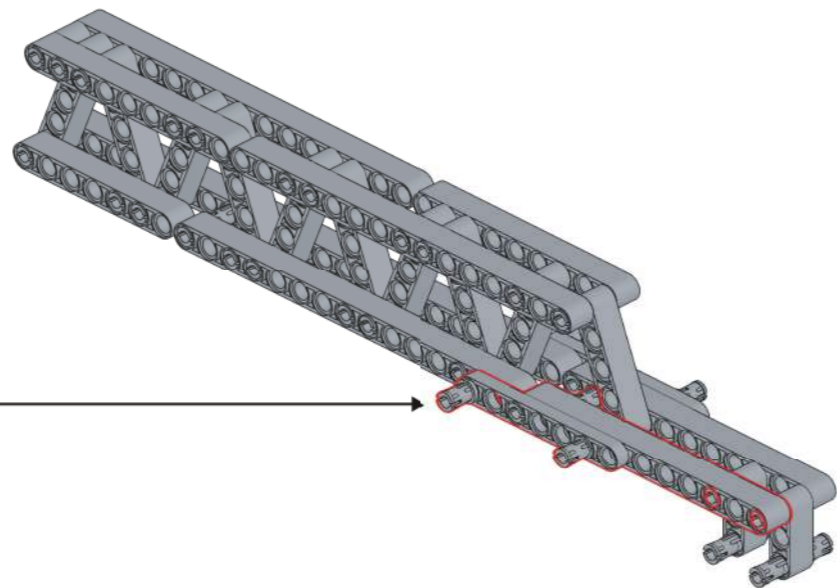
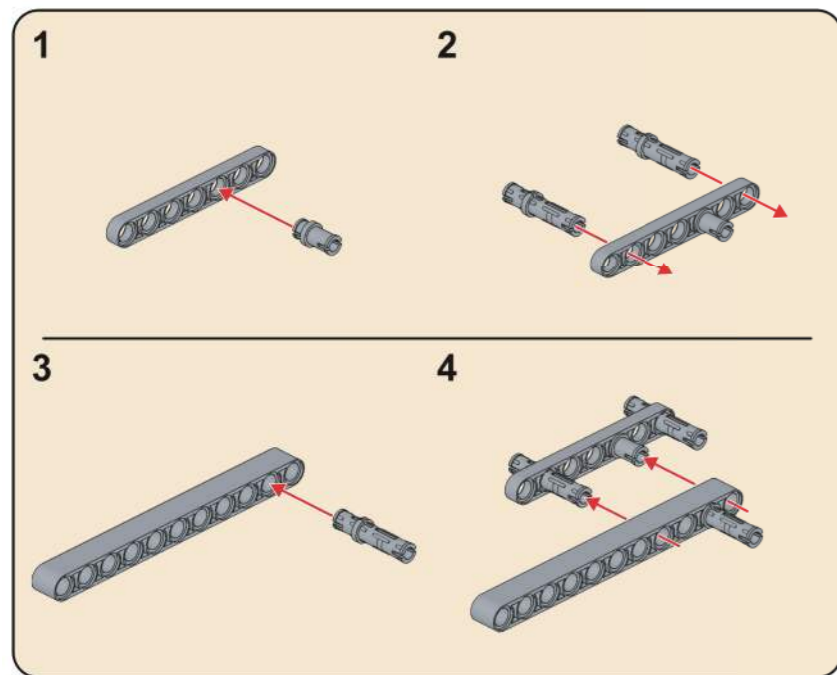

79

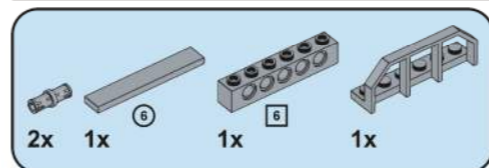
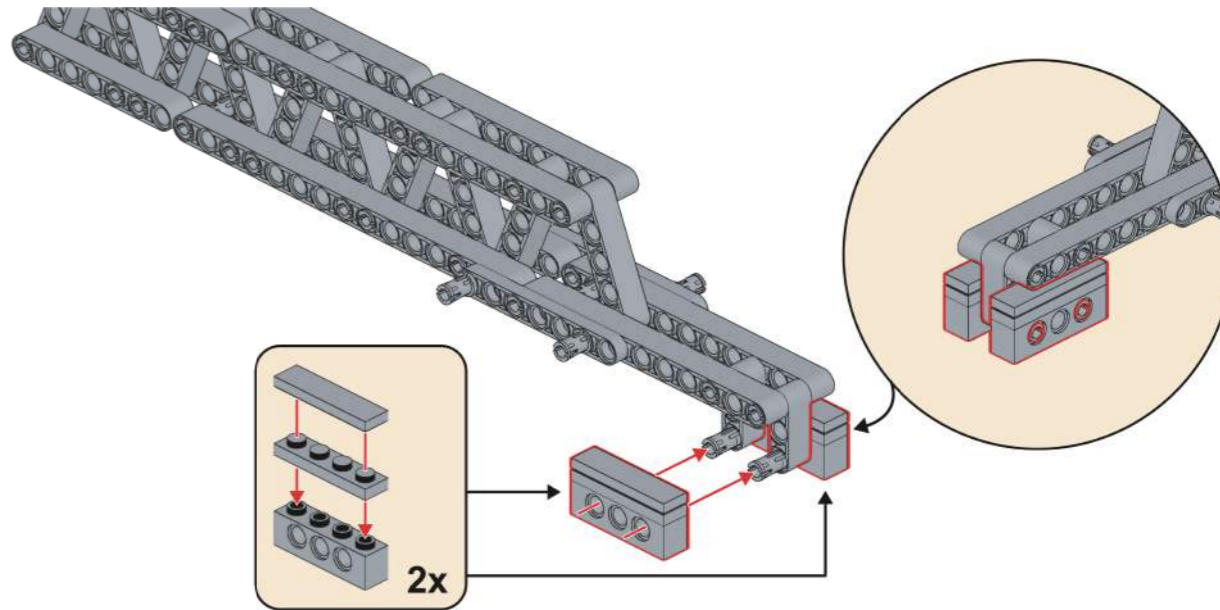

80

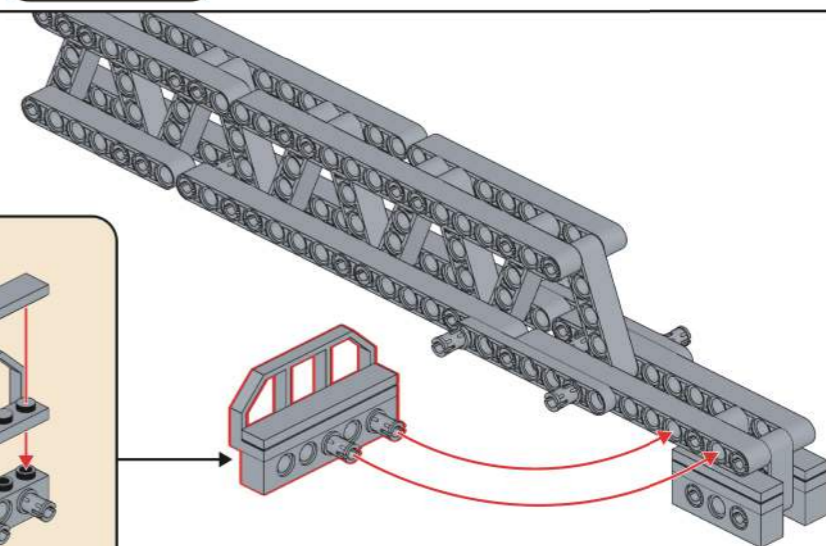
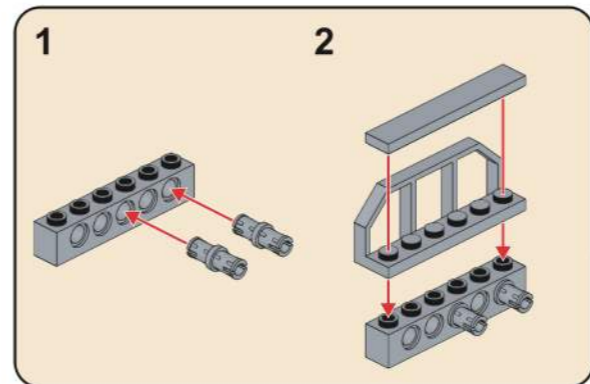

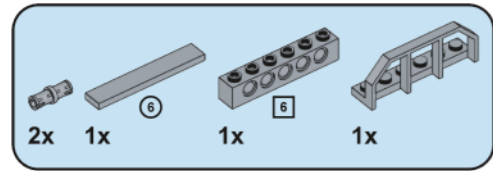

81

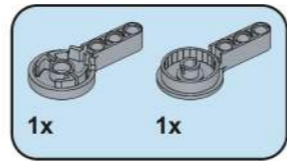
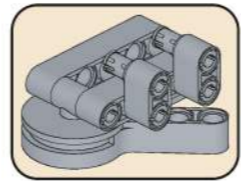
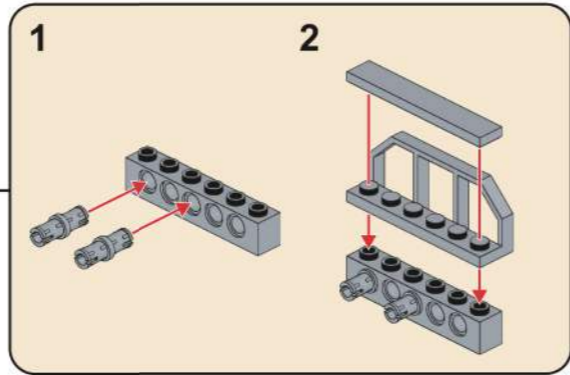
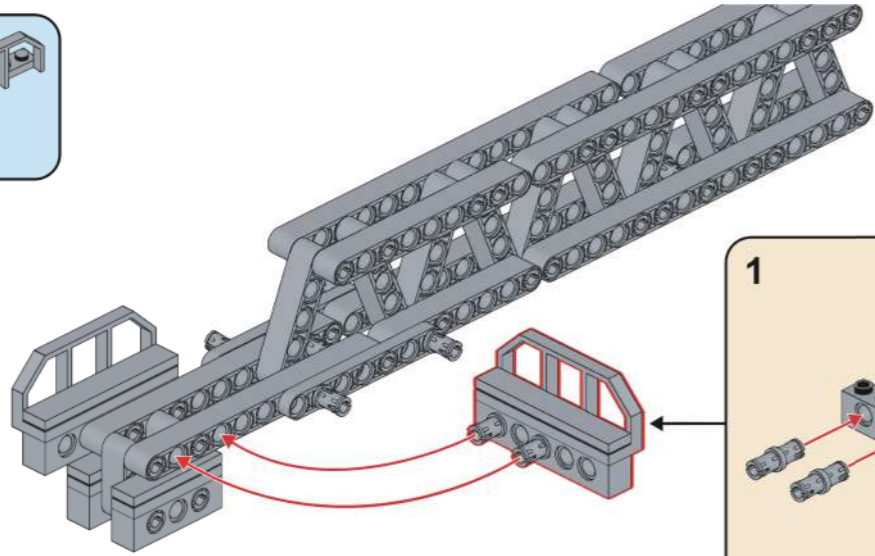

83

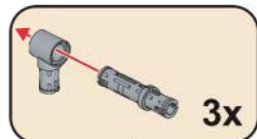
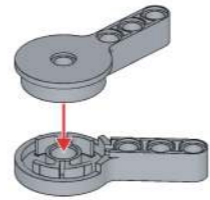

84

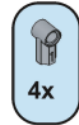
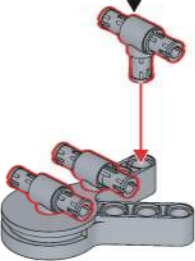

82

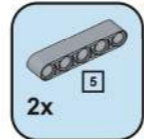
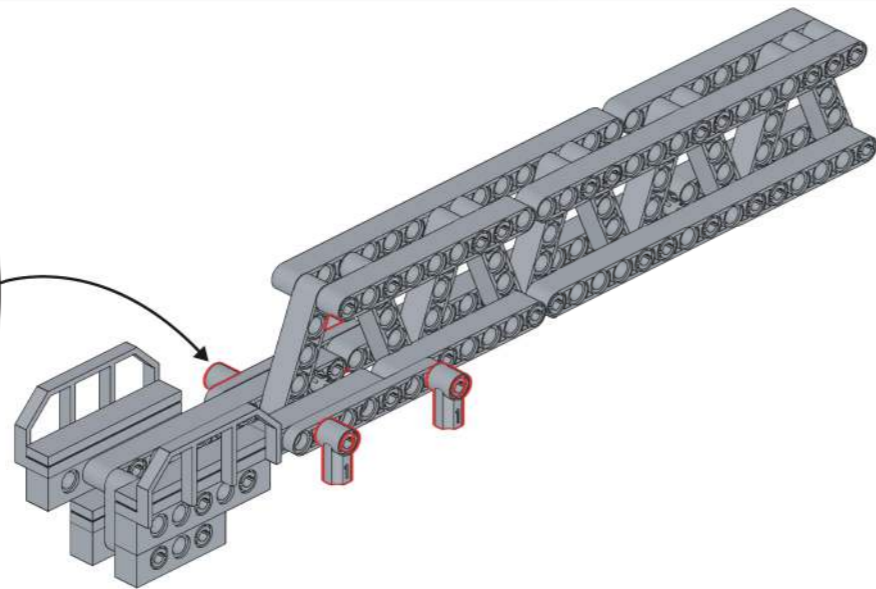
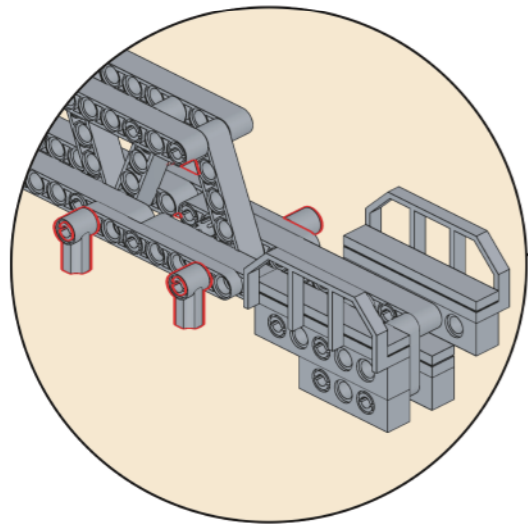

85

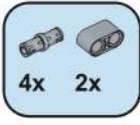
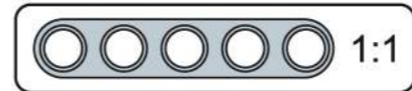
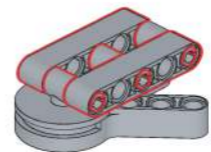

86

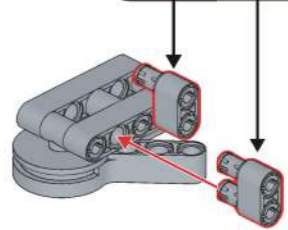
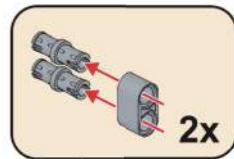

87

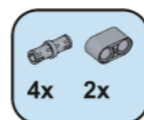
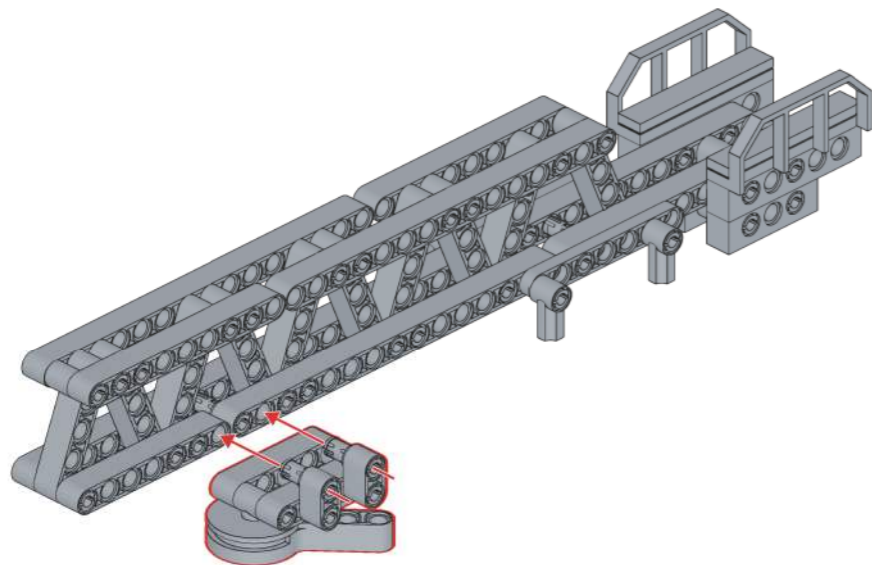

88

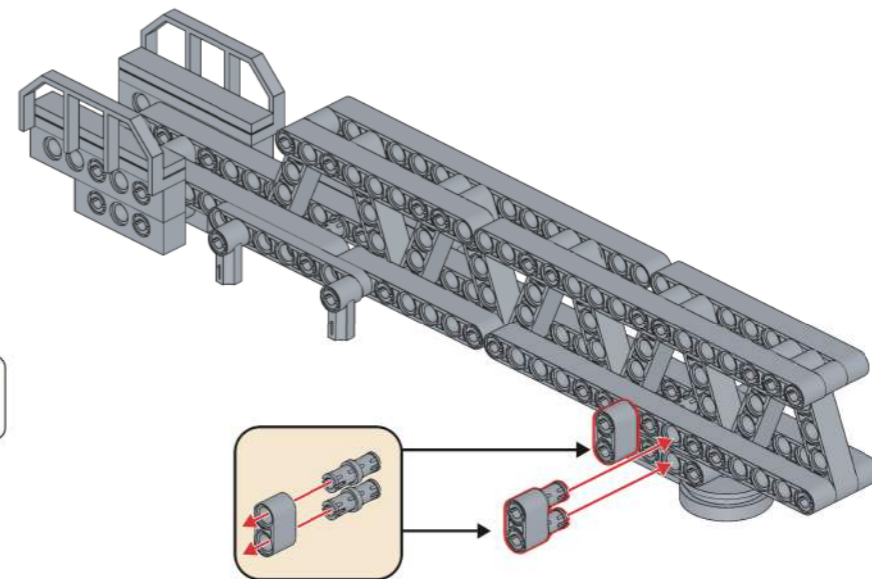

89

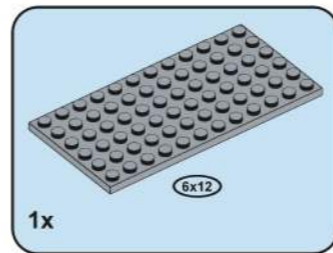
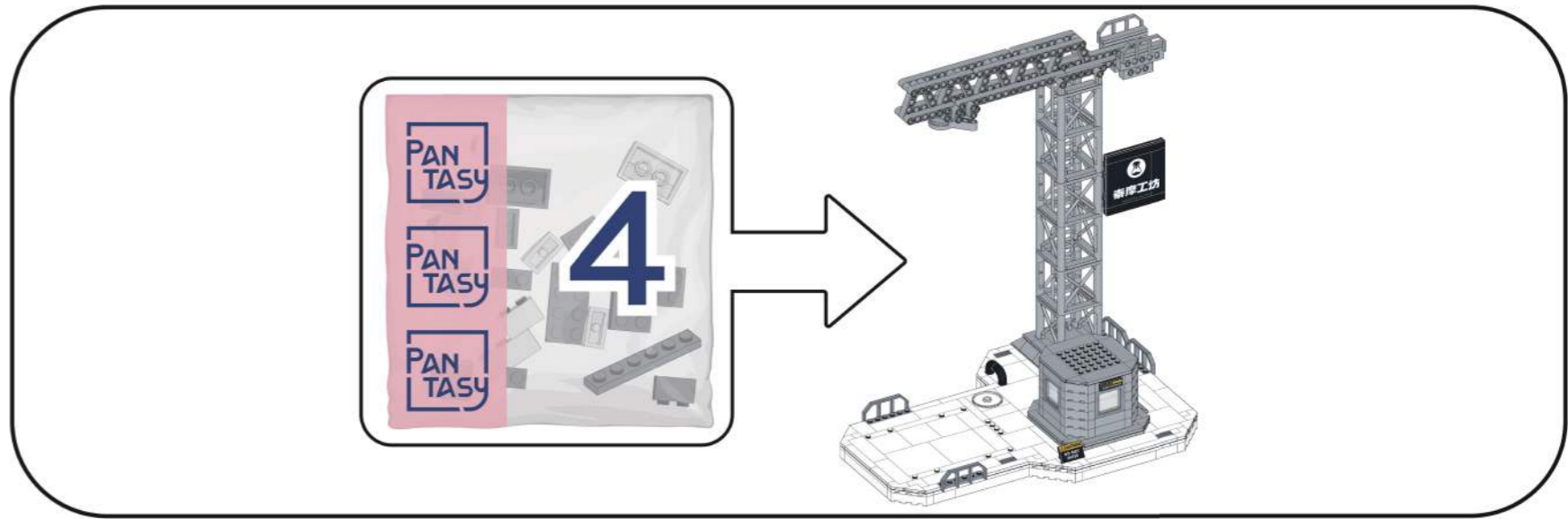
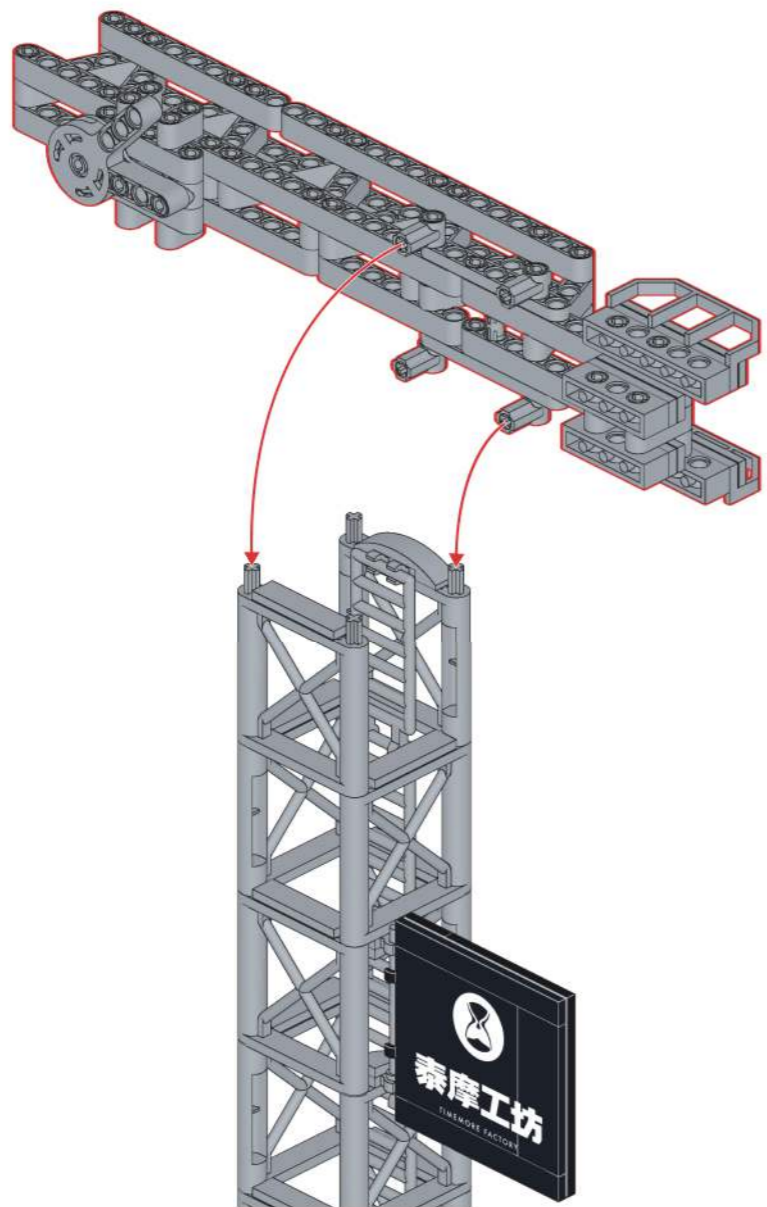

90

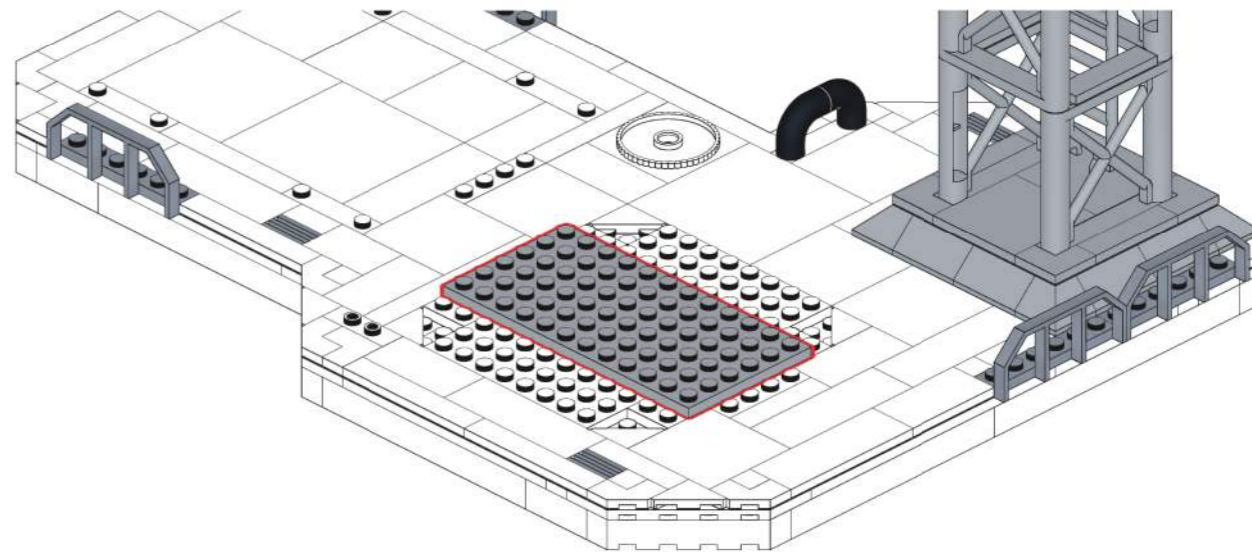

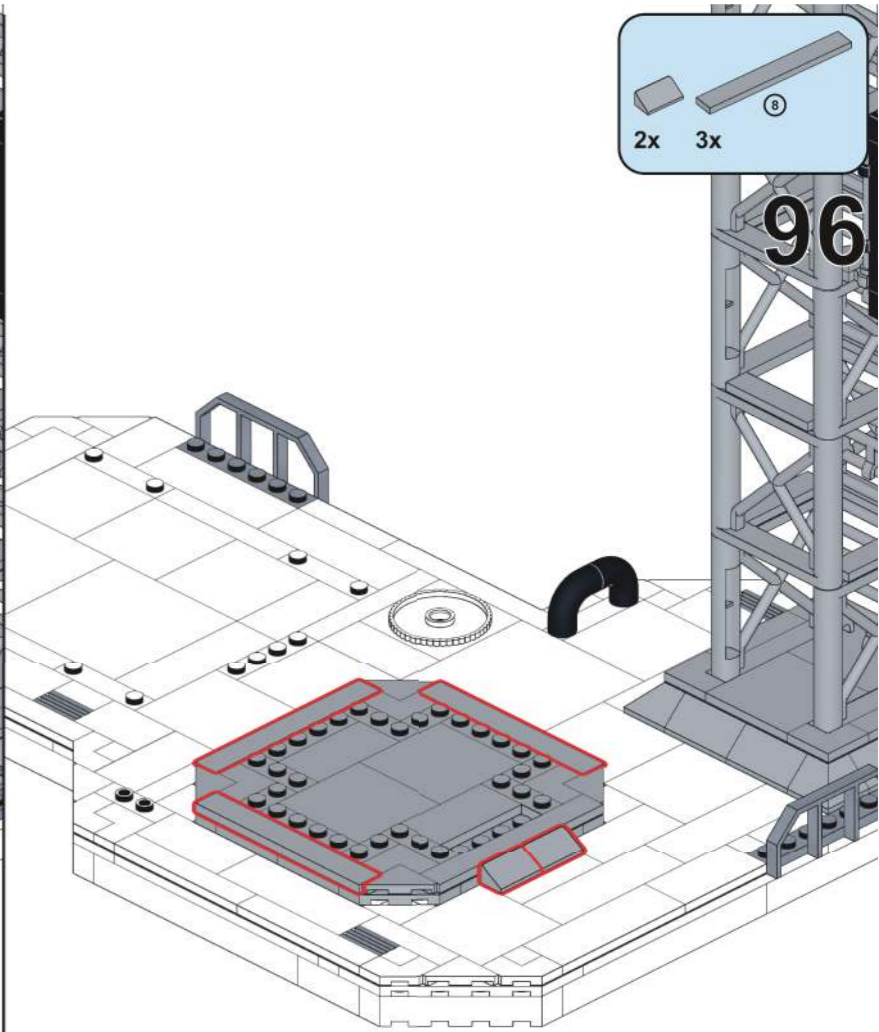
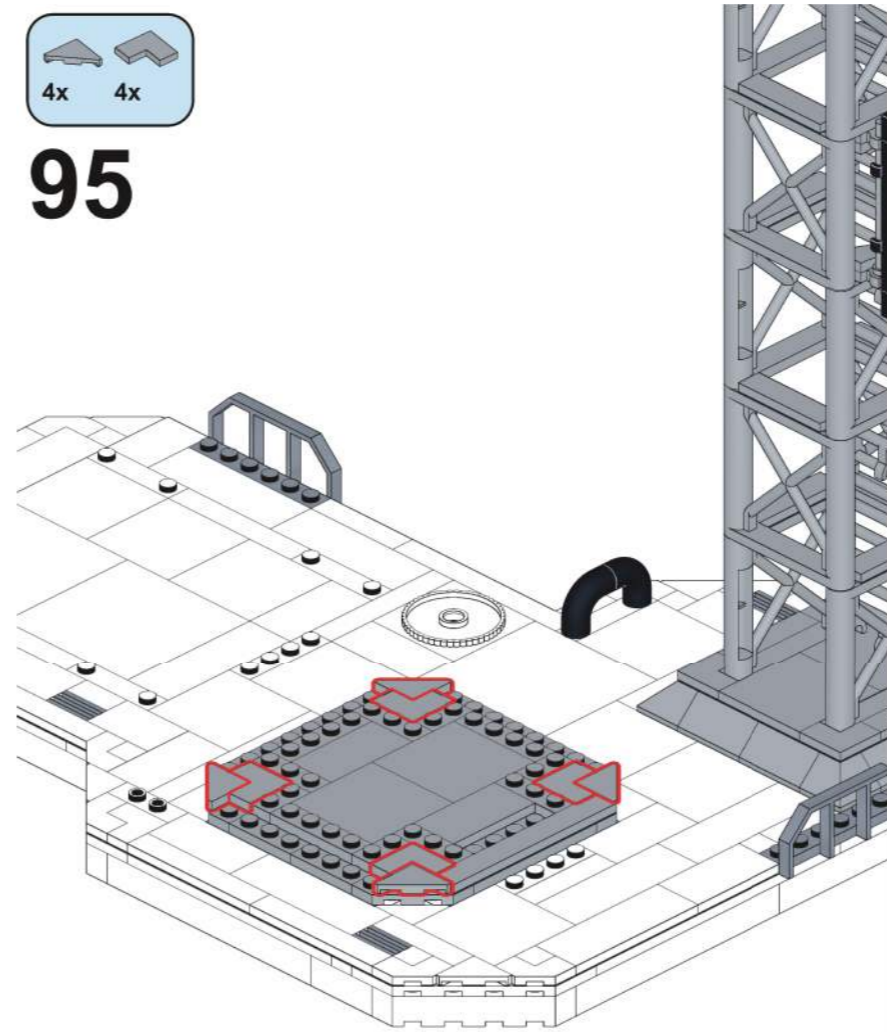
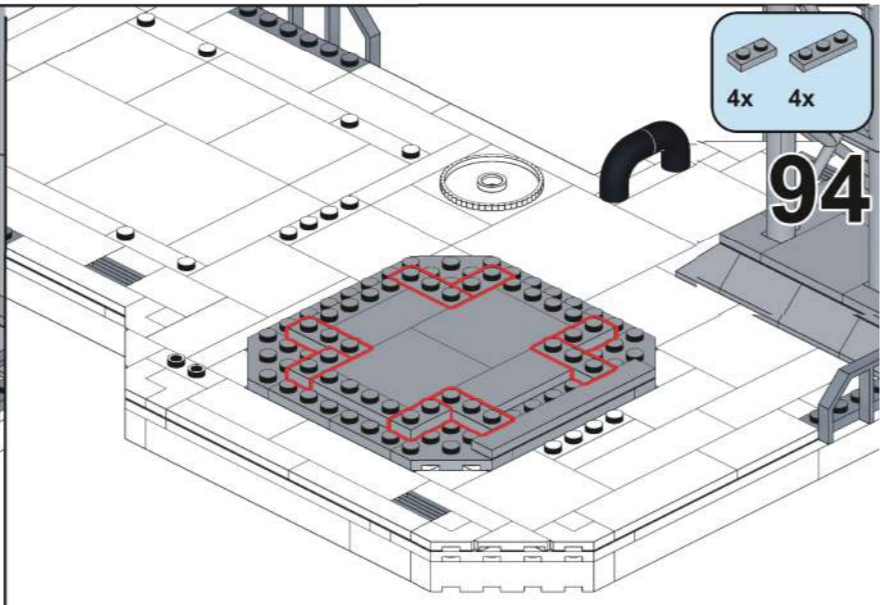
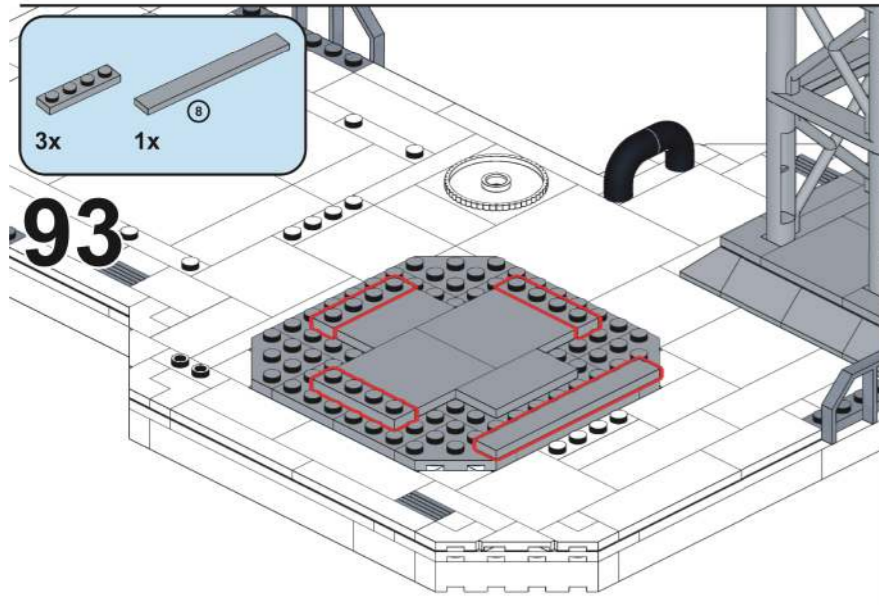
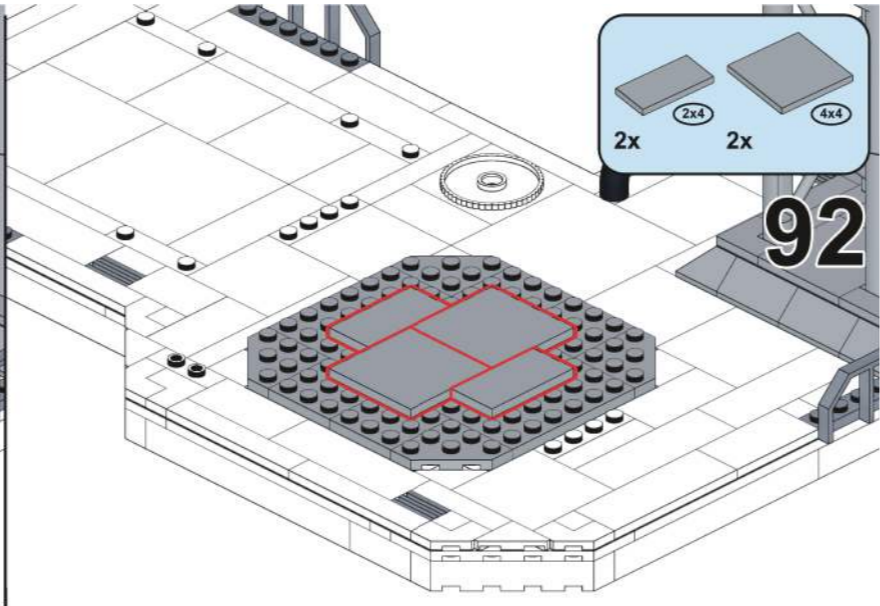
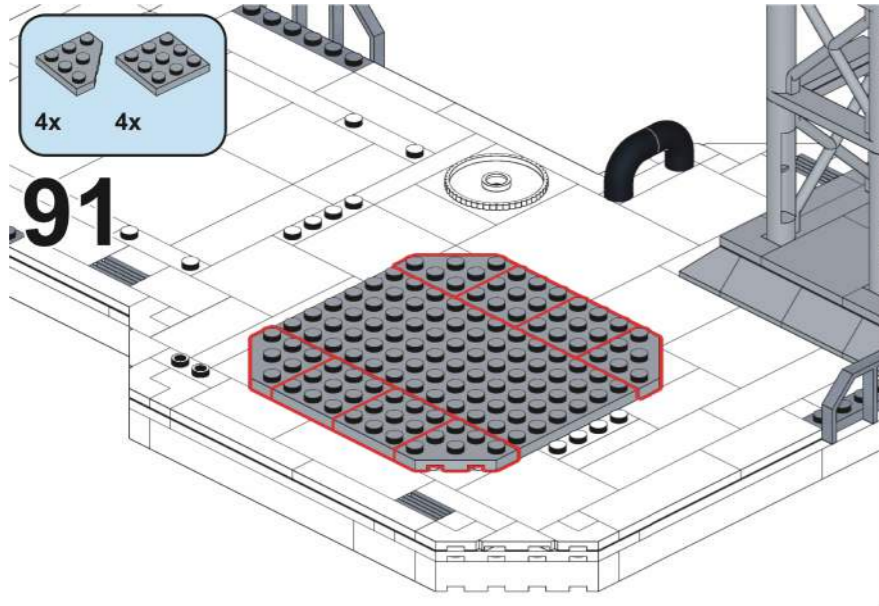

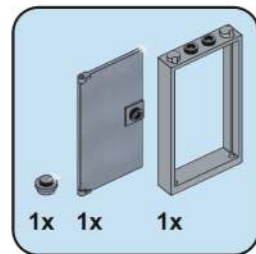

97

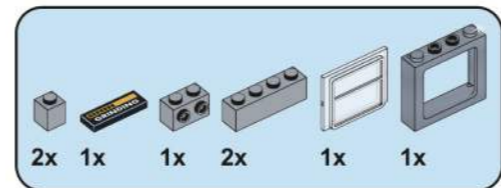
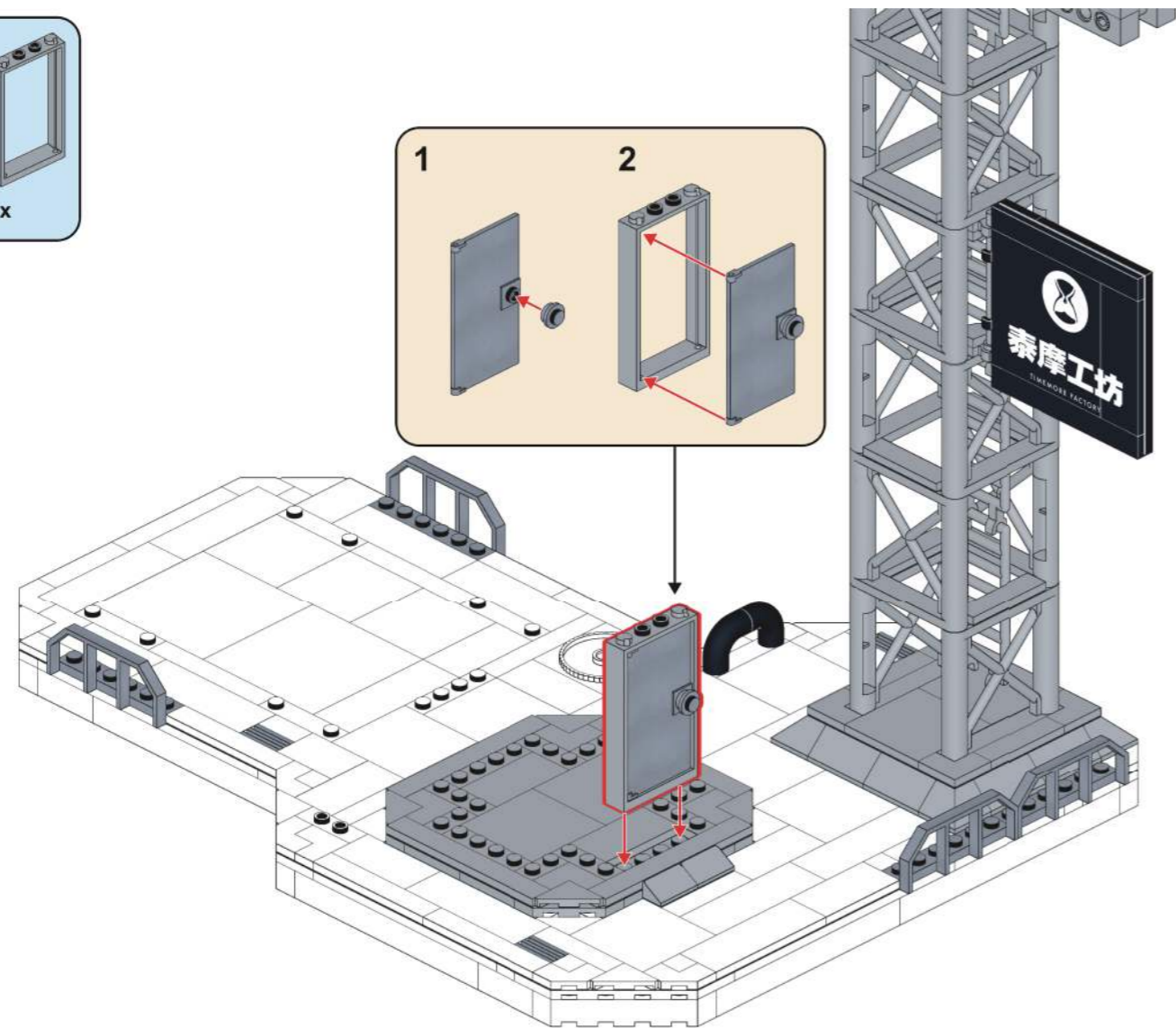
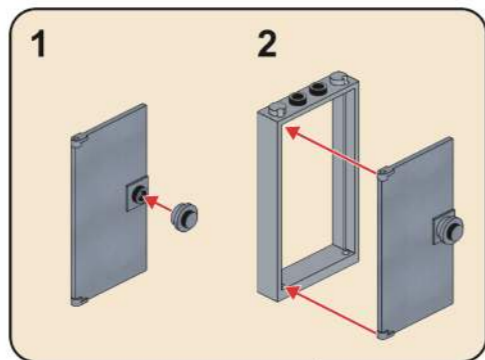

98

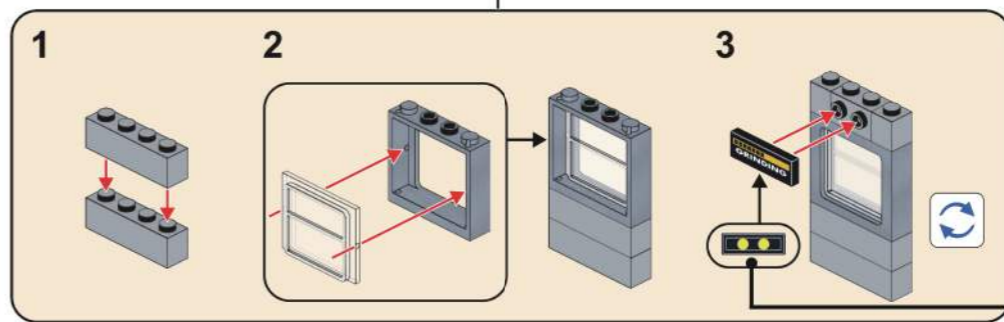
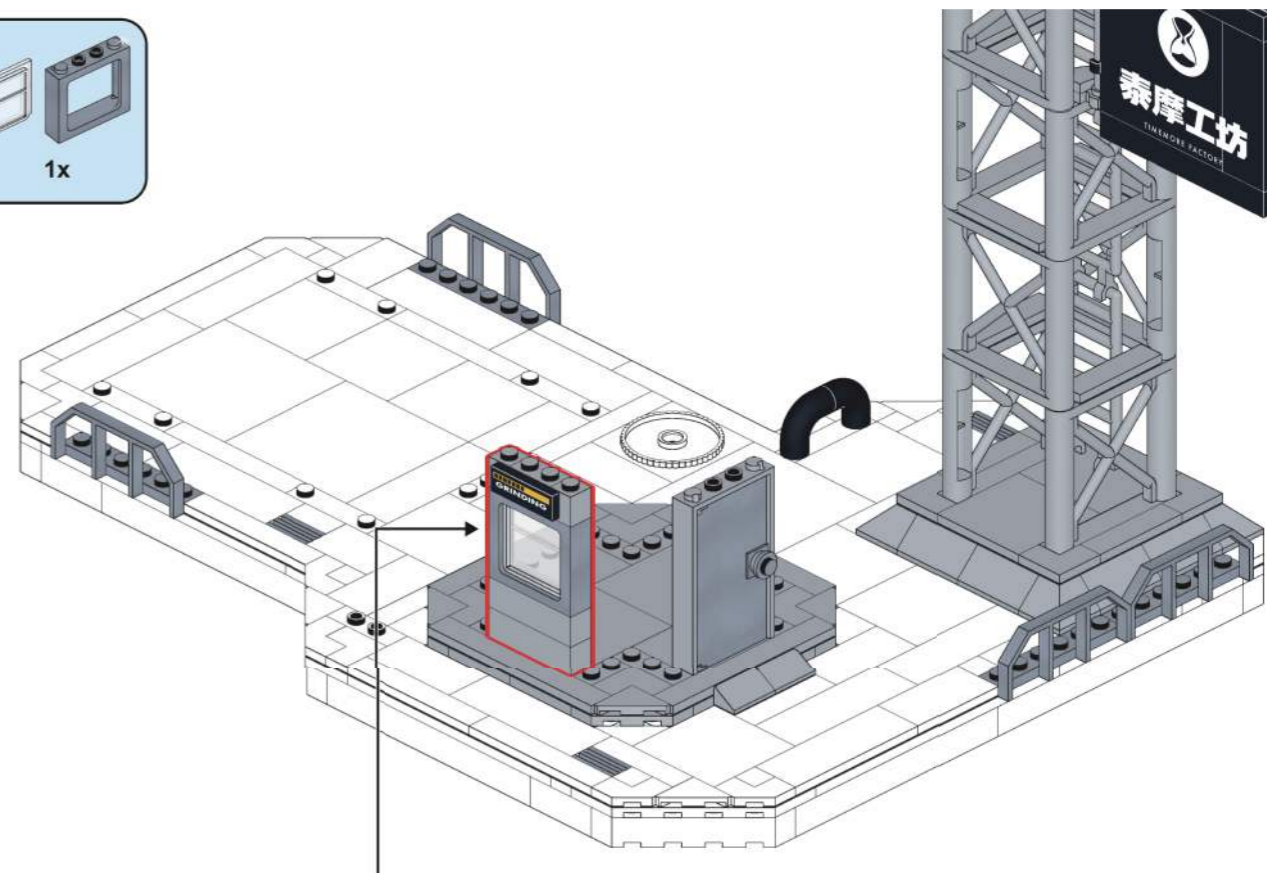

请注意零件的对点位置。

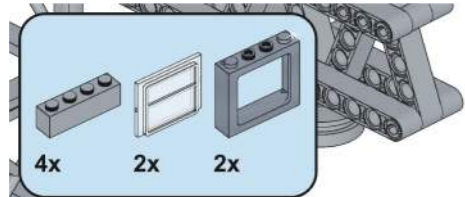

99

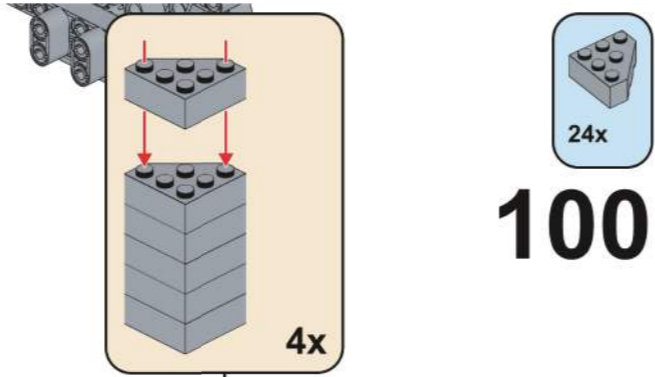
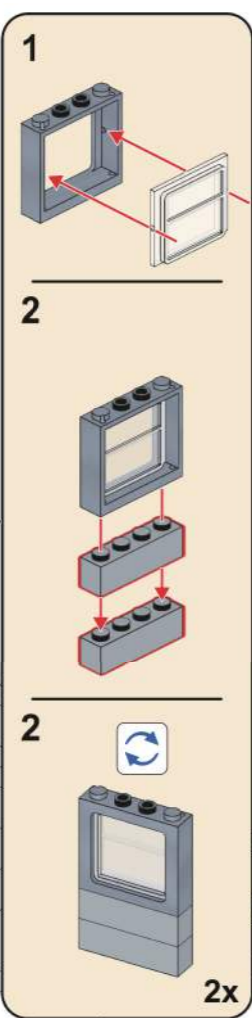
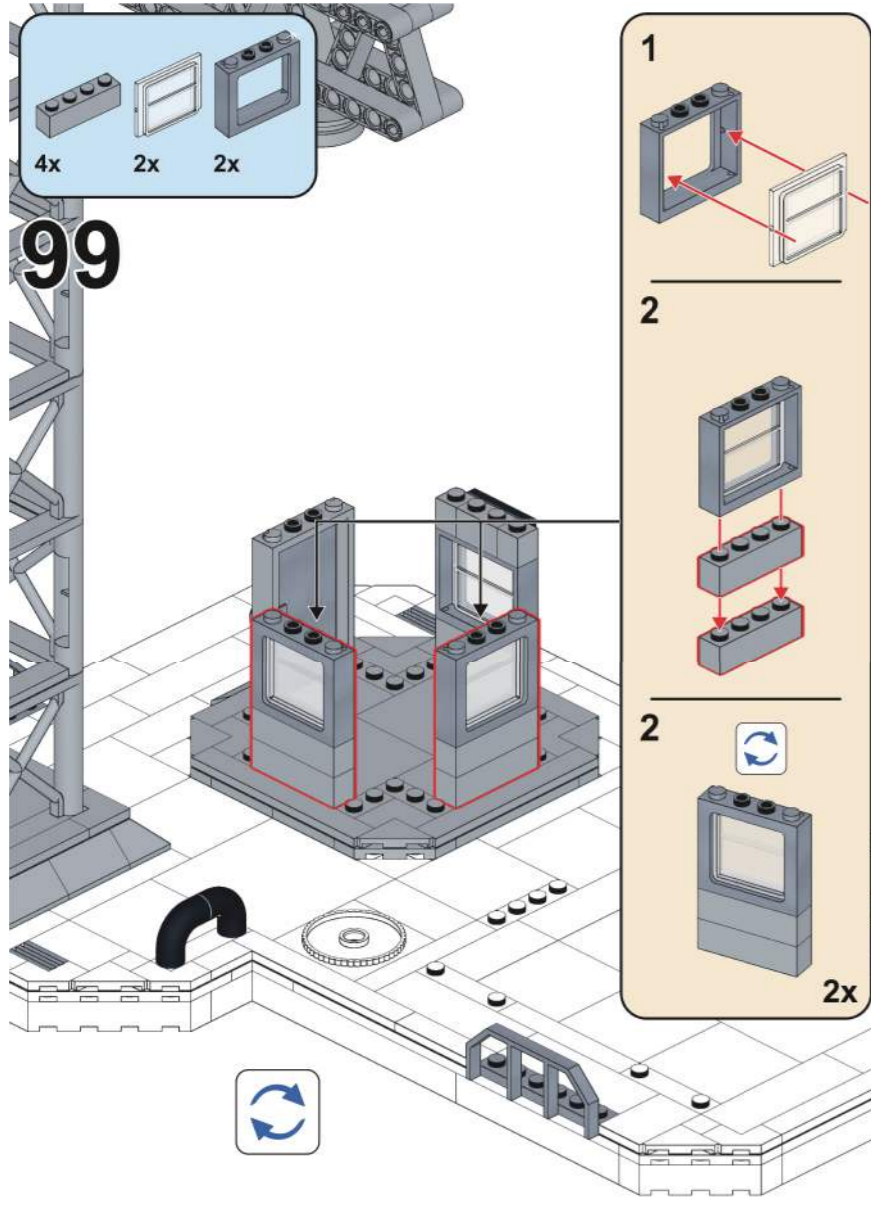

100

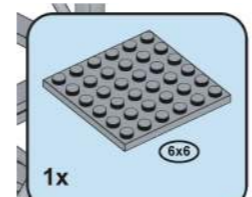
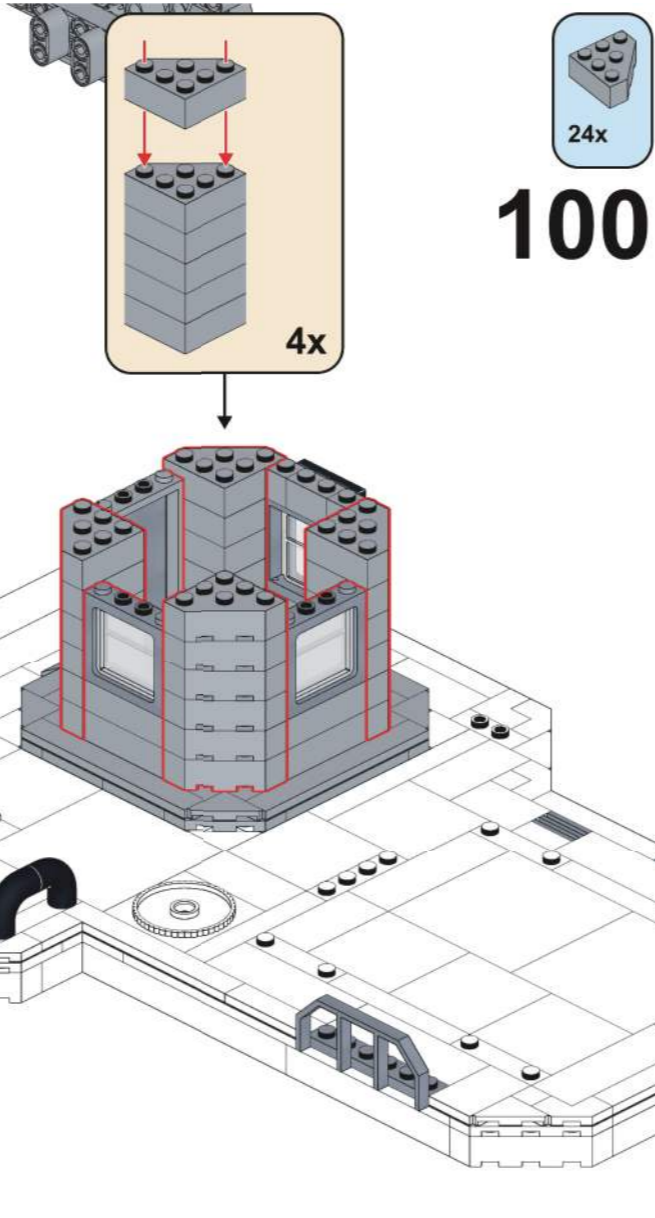

101

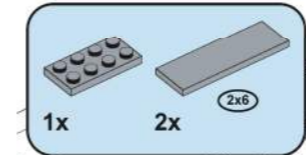
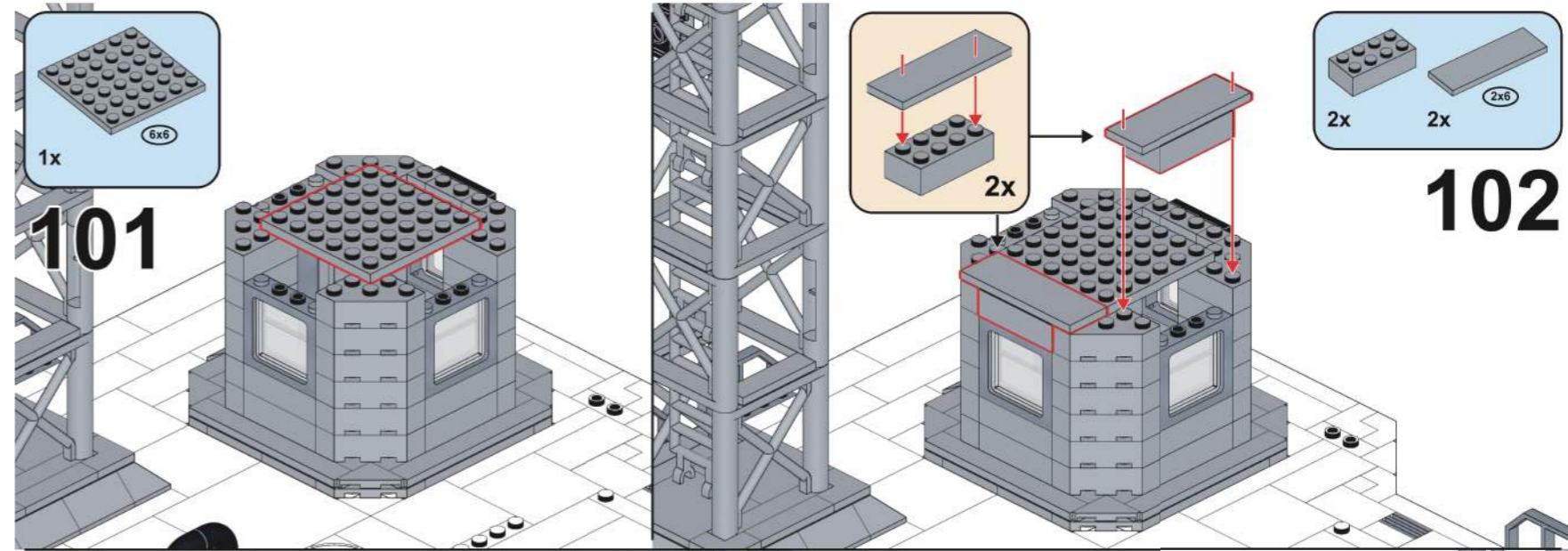

103

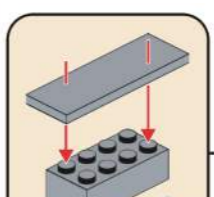
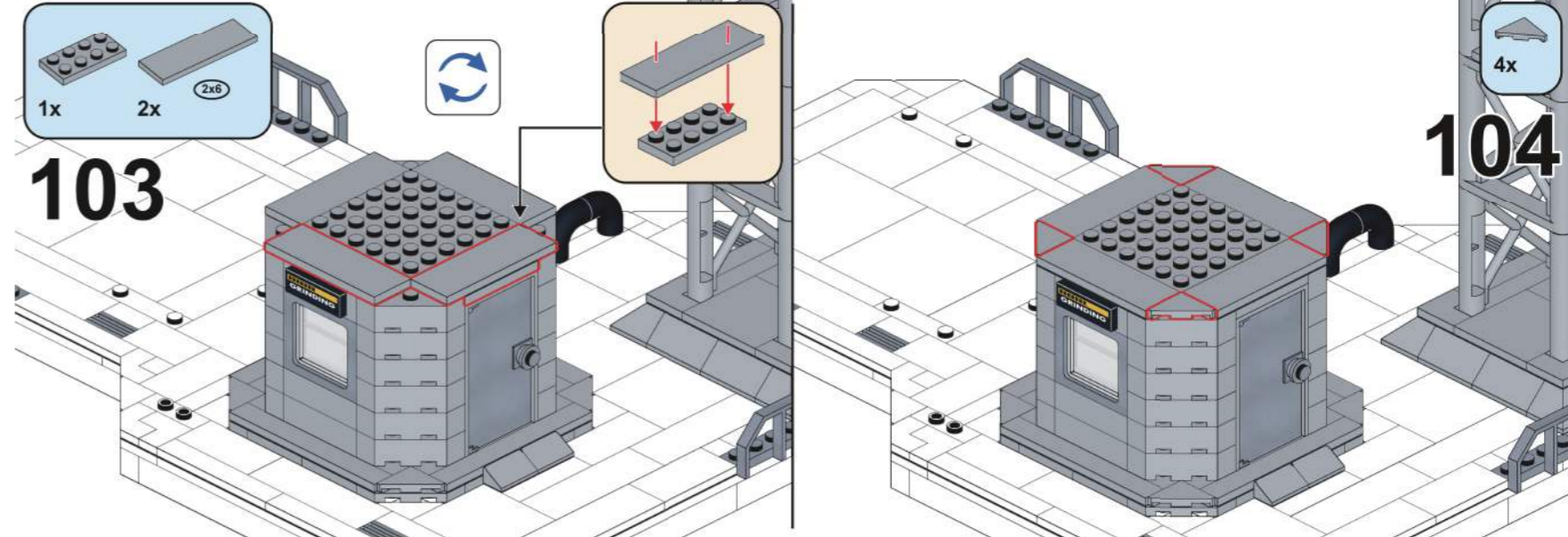

102

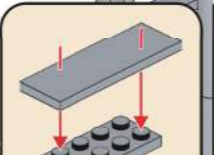
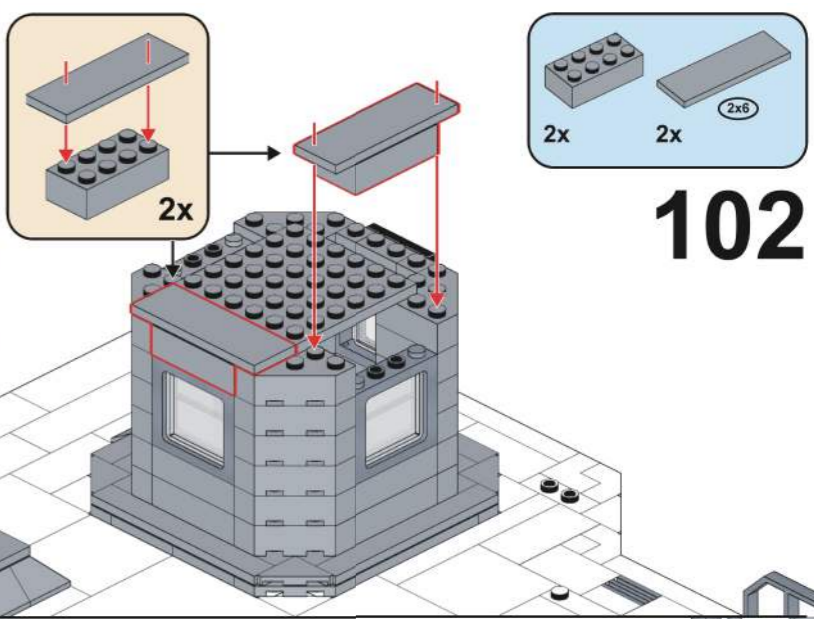

104

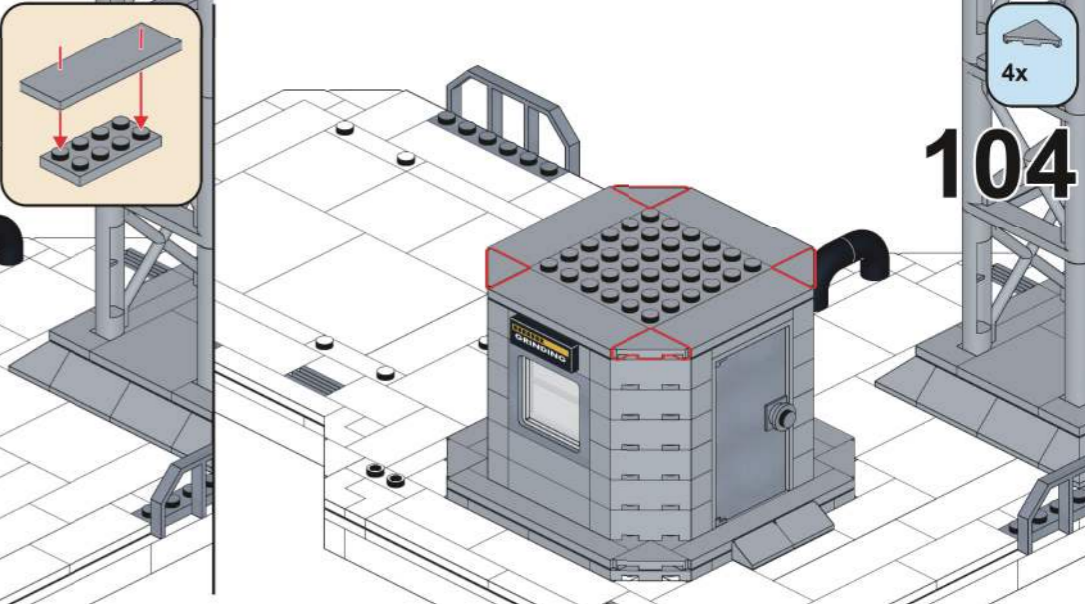

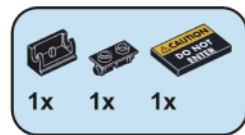

105

请注意拼装时图案的方向。

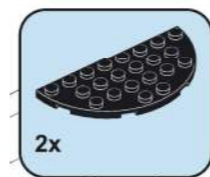
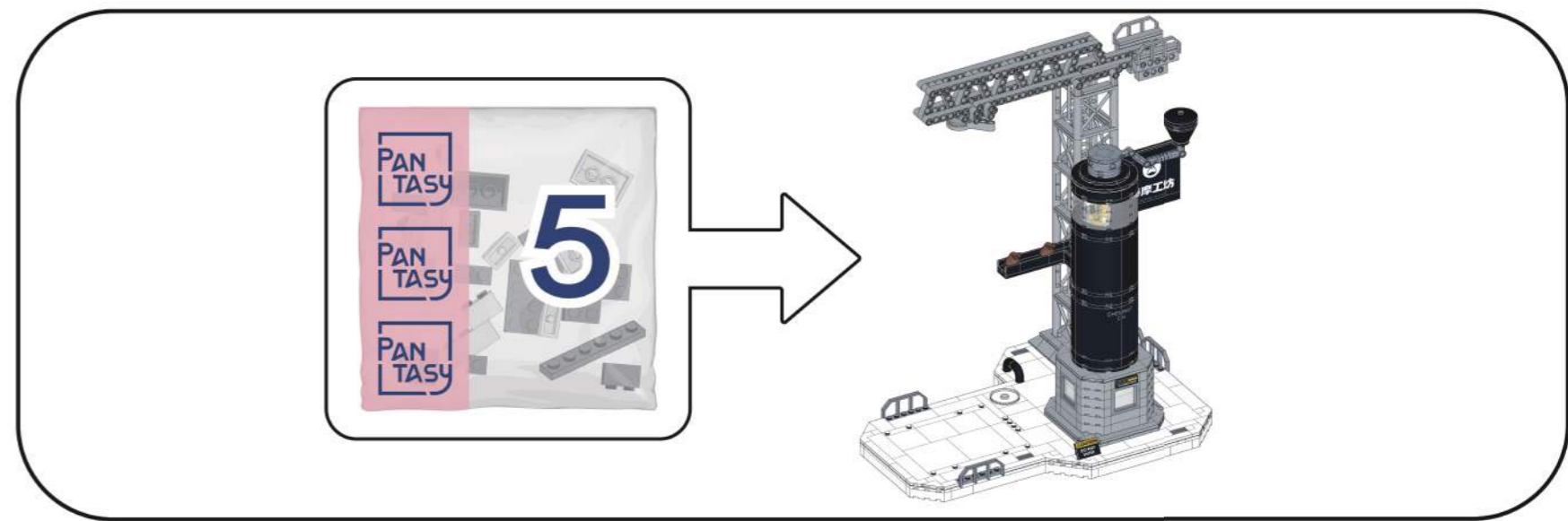
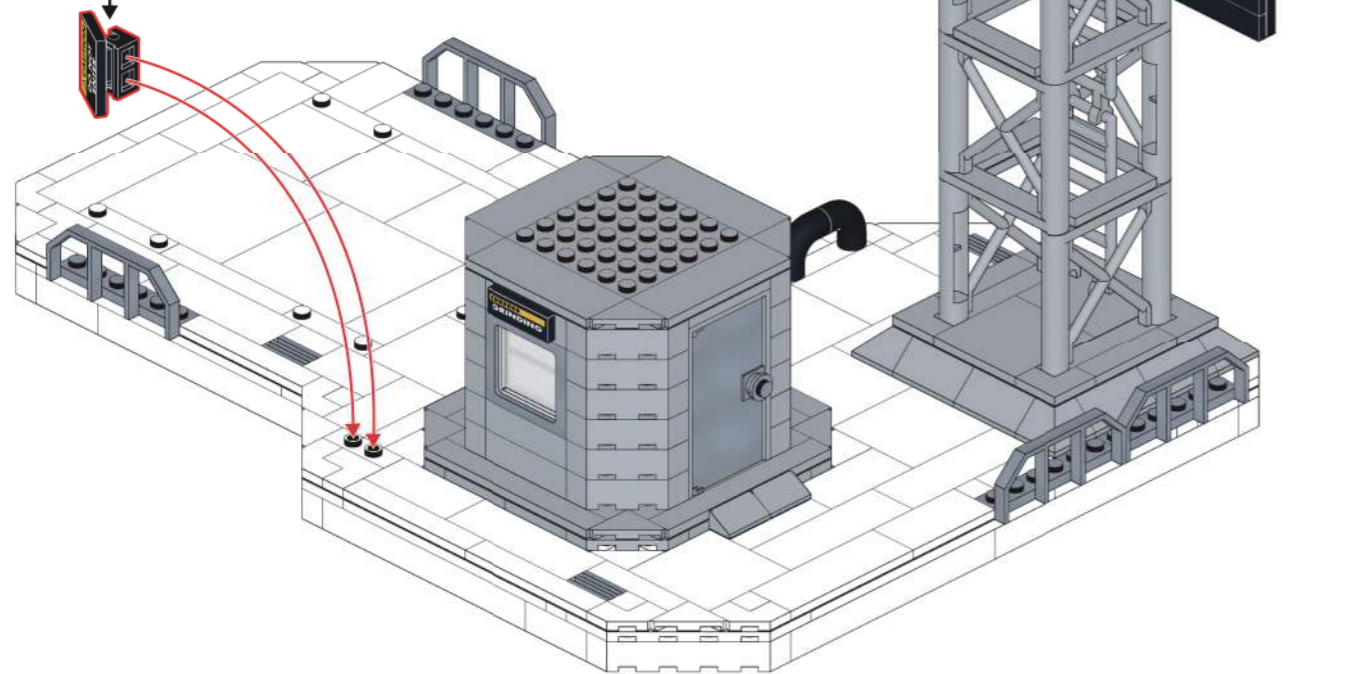
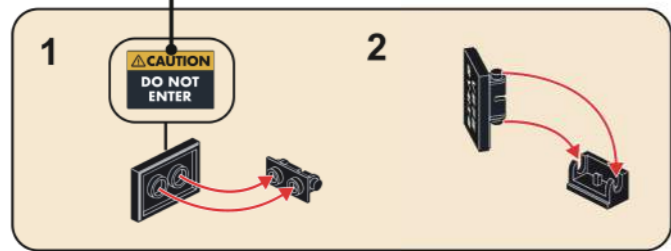

106

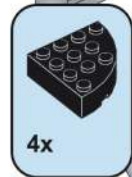
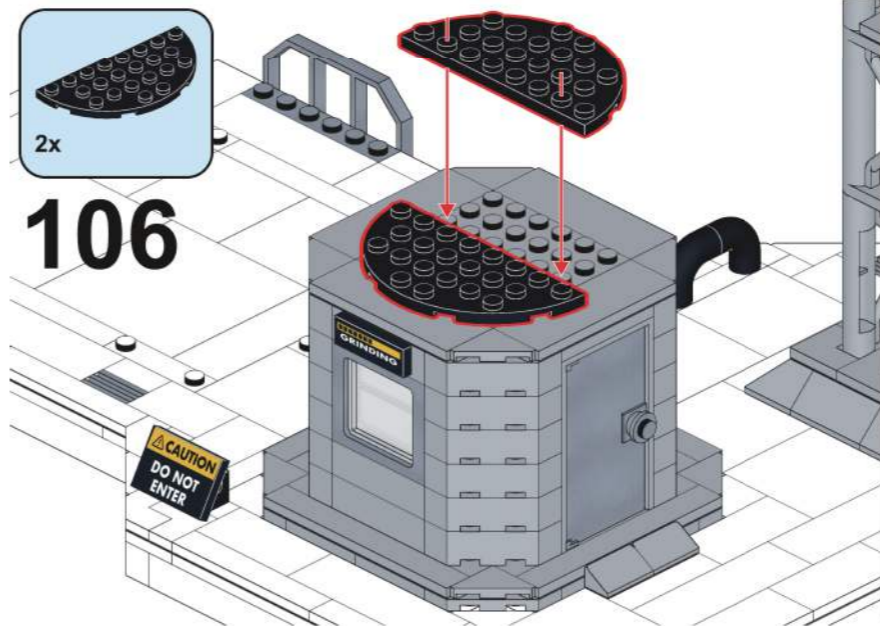

107

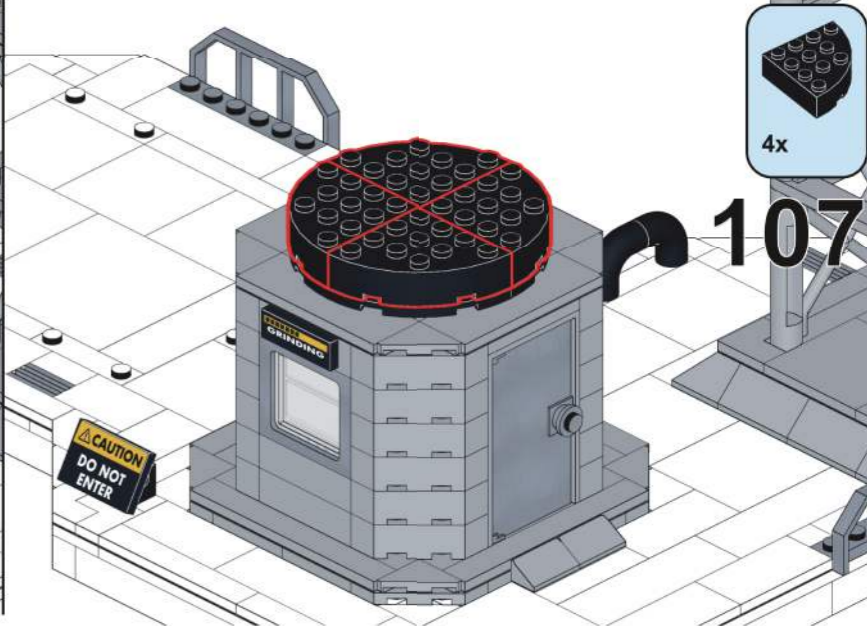

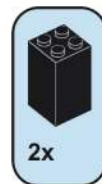

108

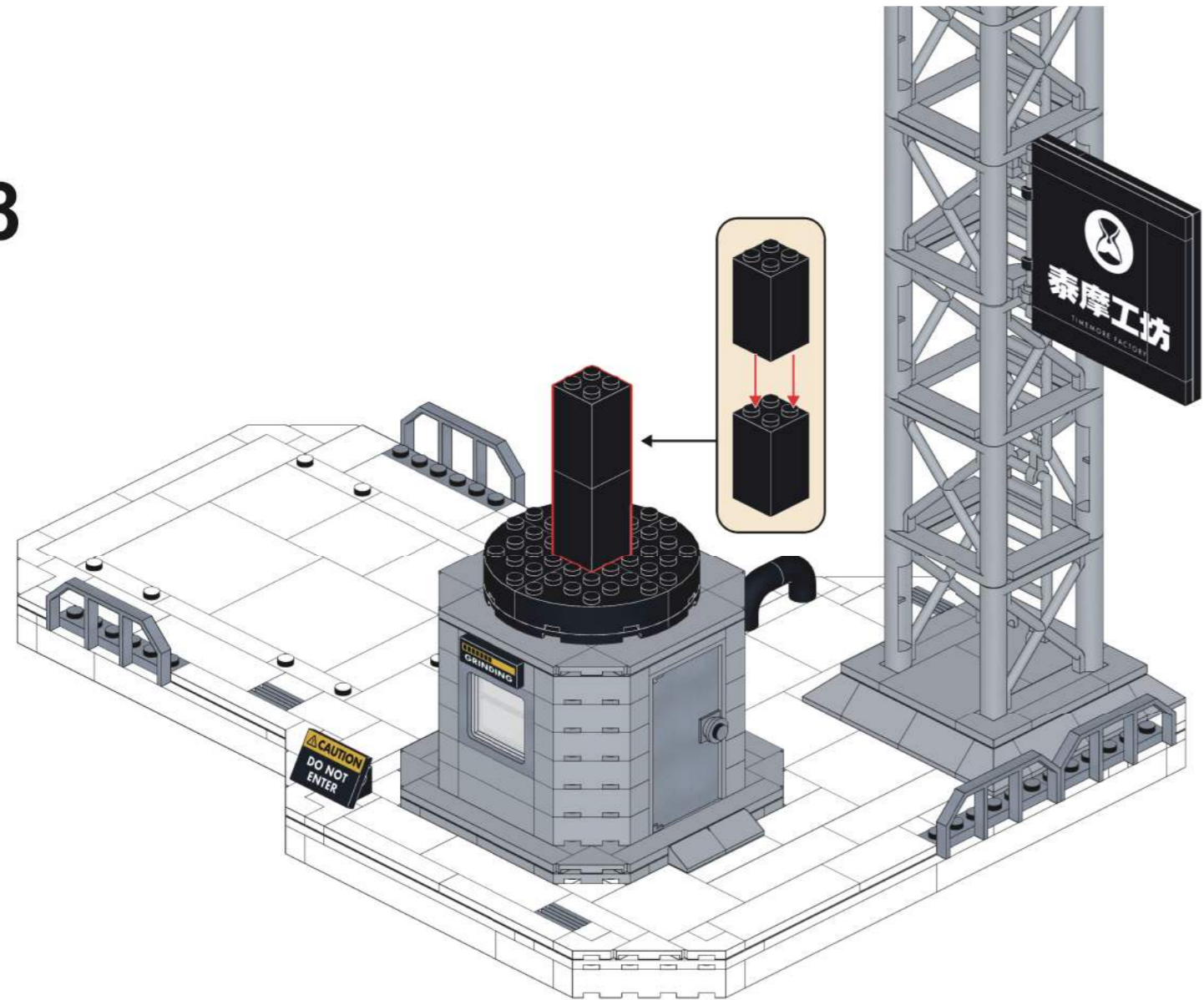

109

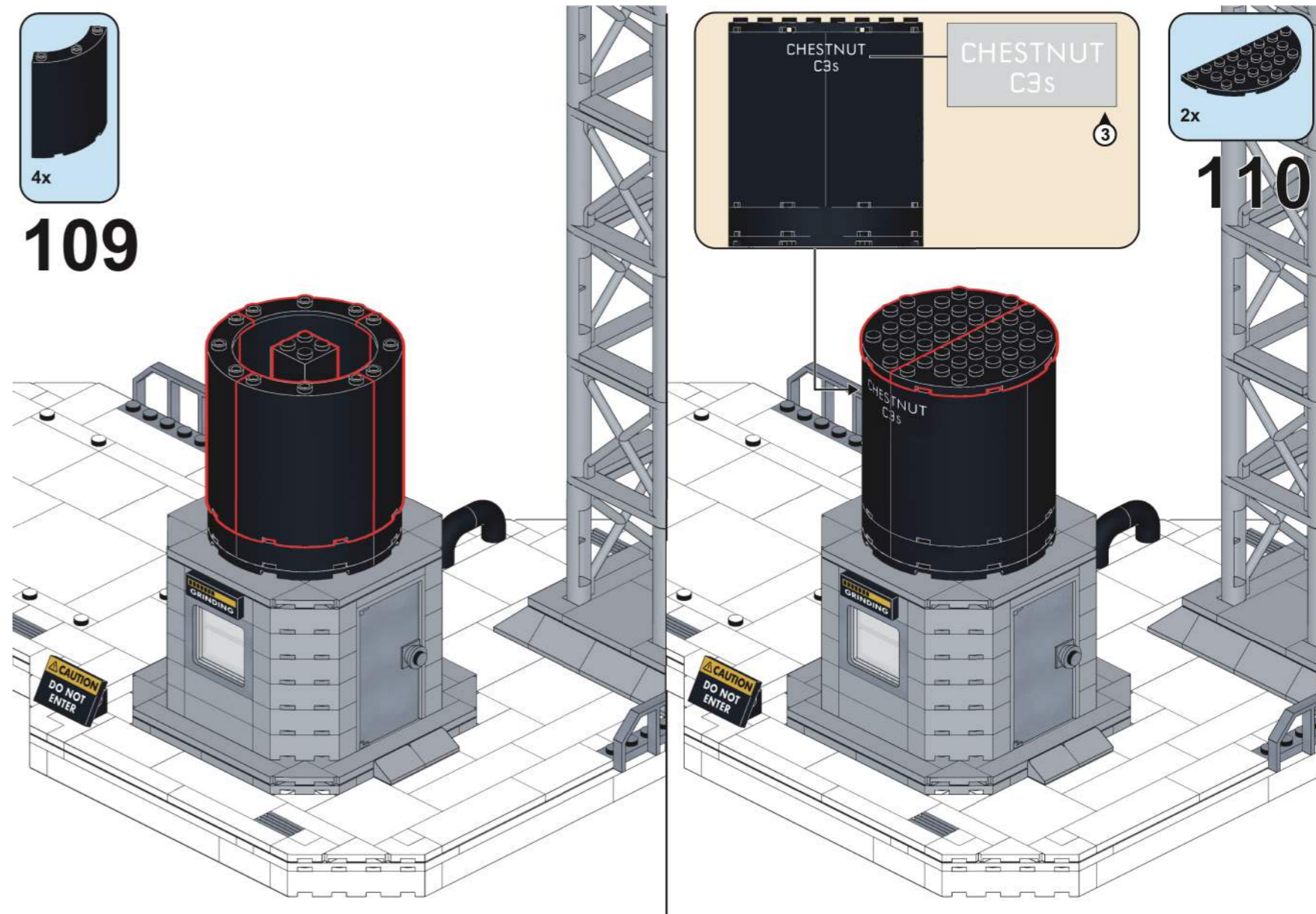

110

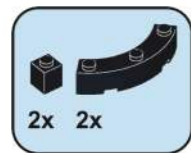

111

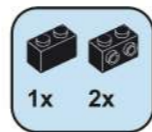
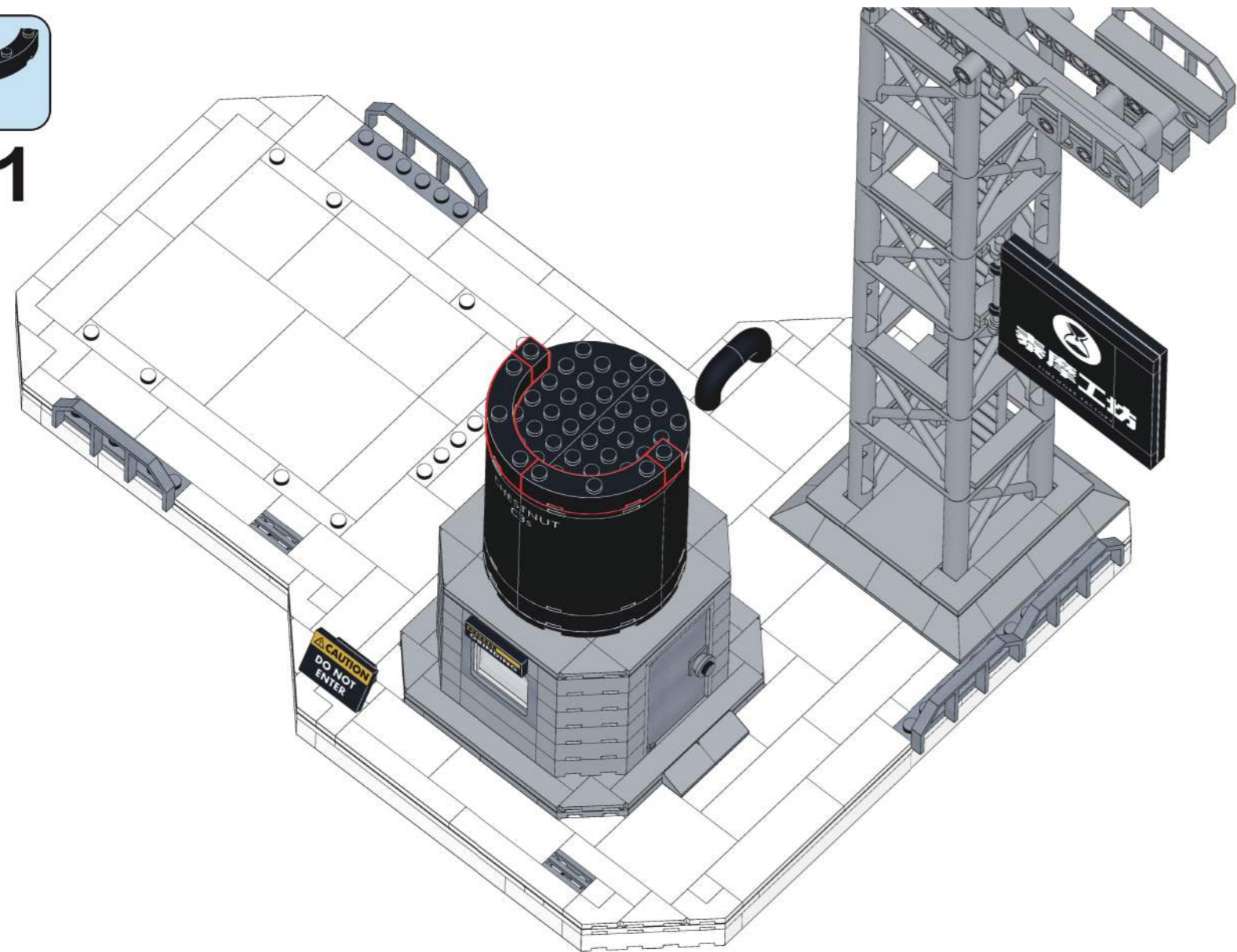

112

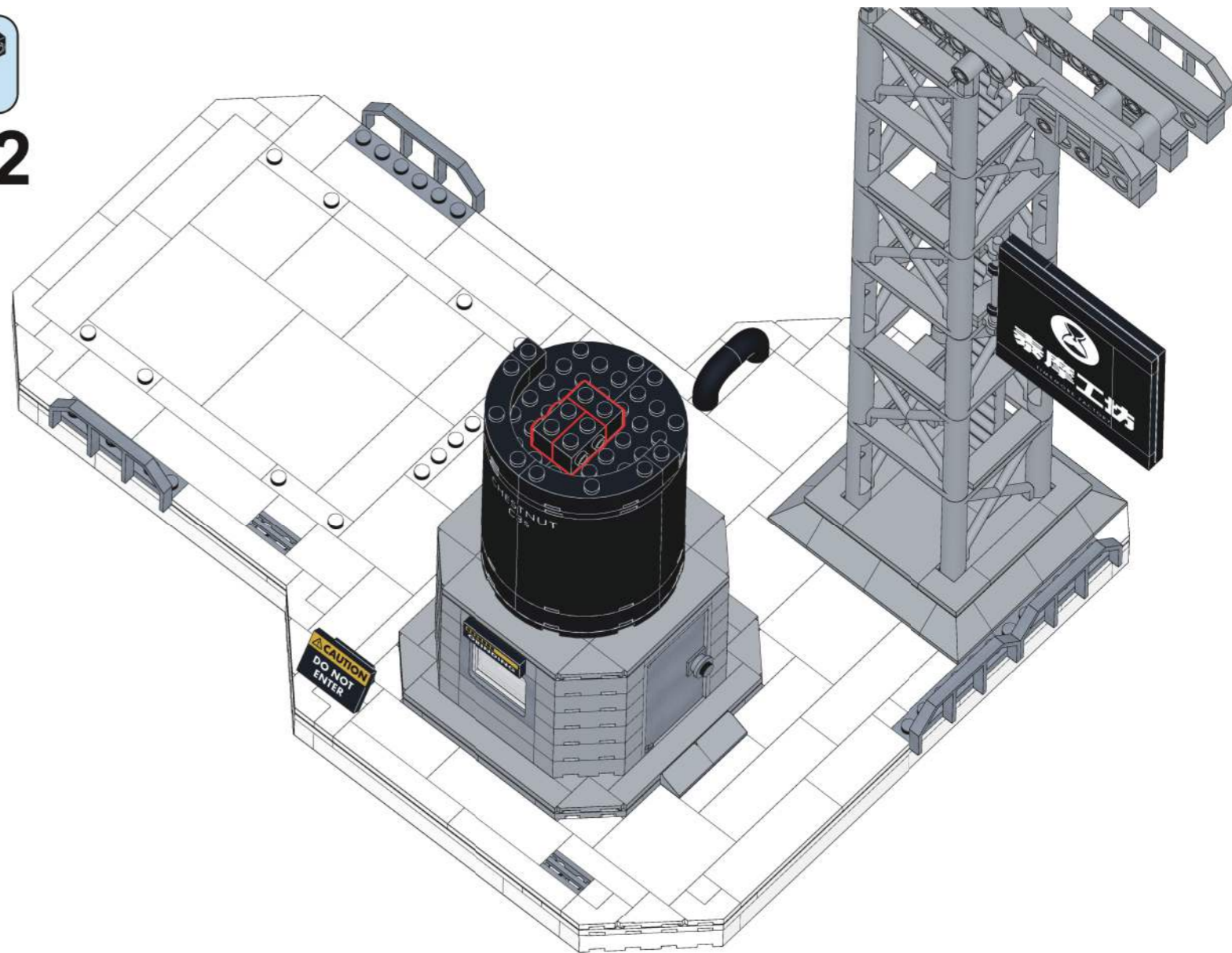

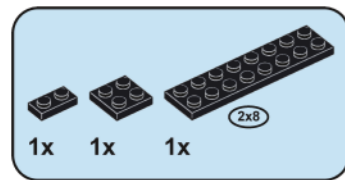

113

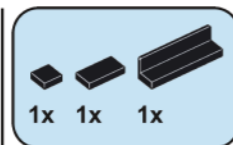
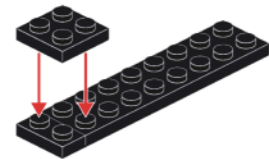

114

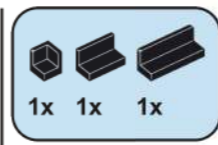
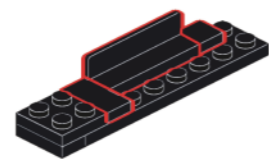

115

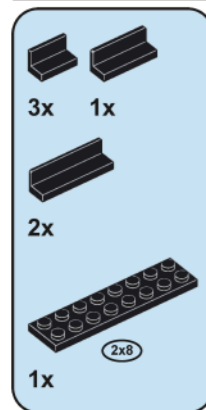
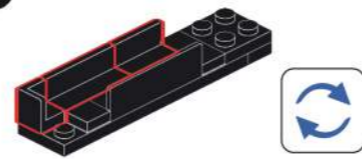

116

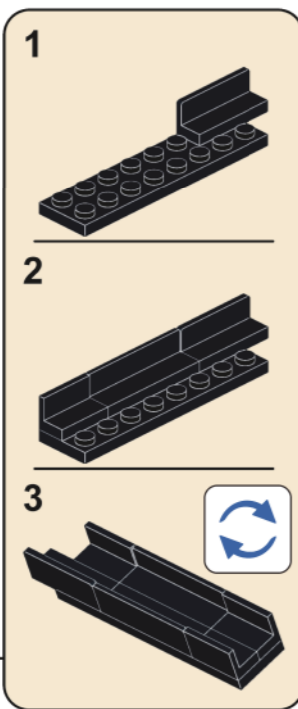
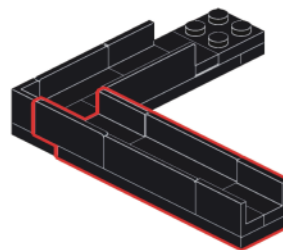

117

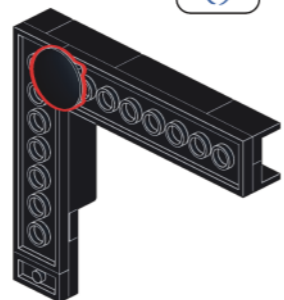

118

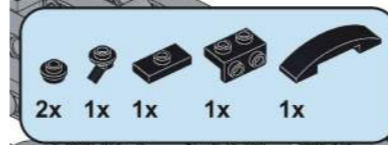
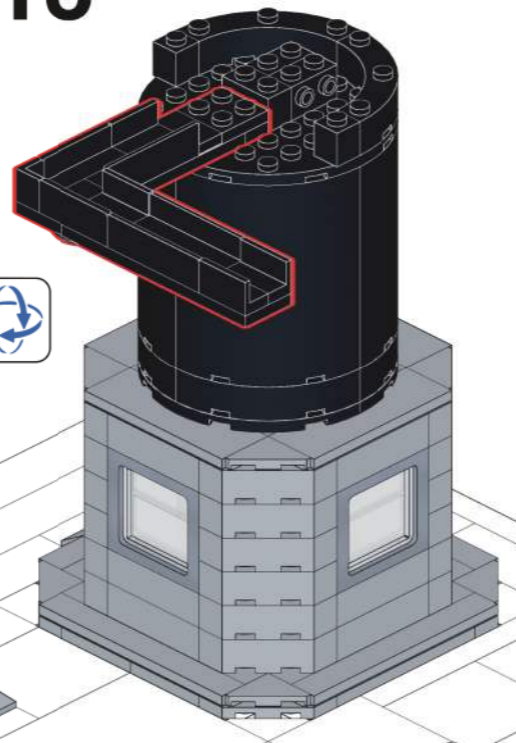

119

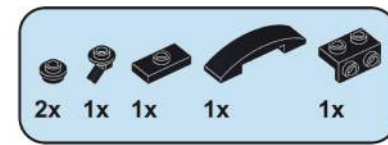
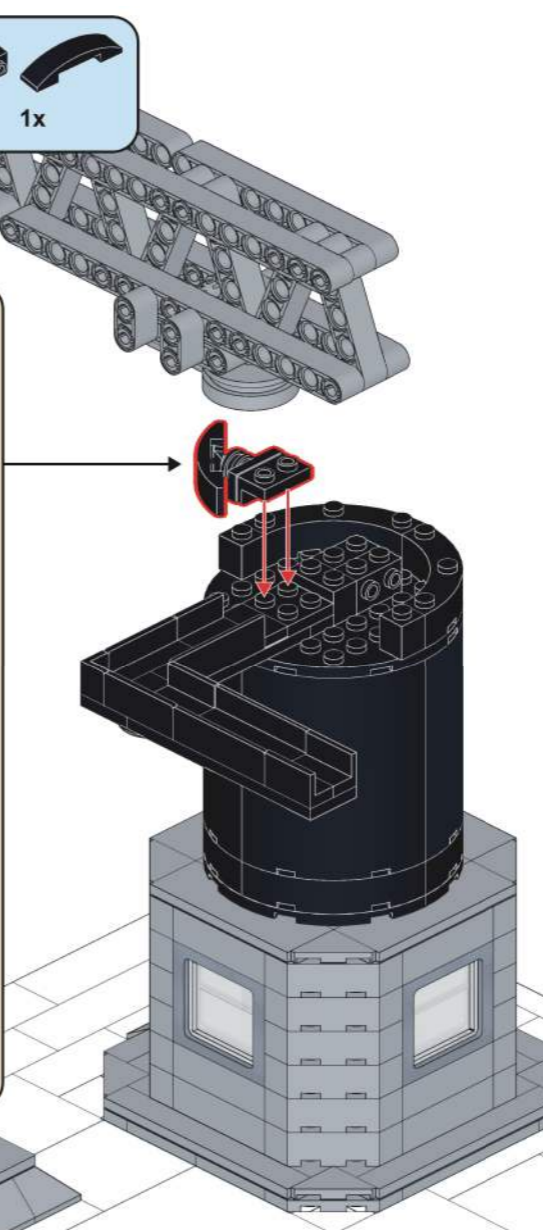
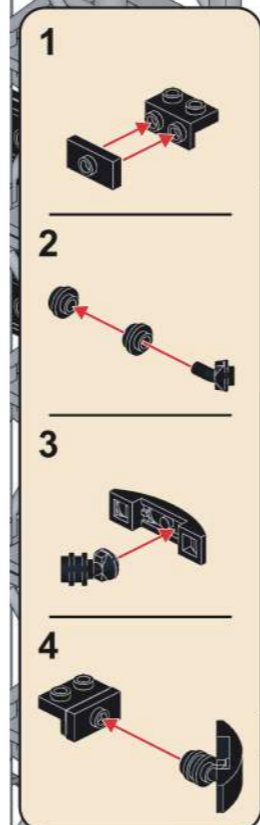

120

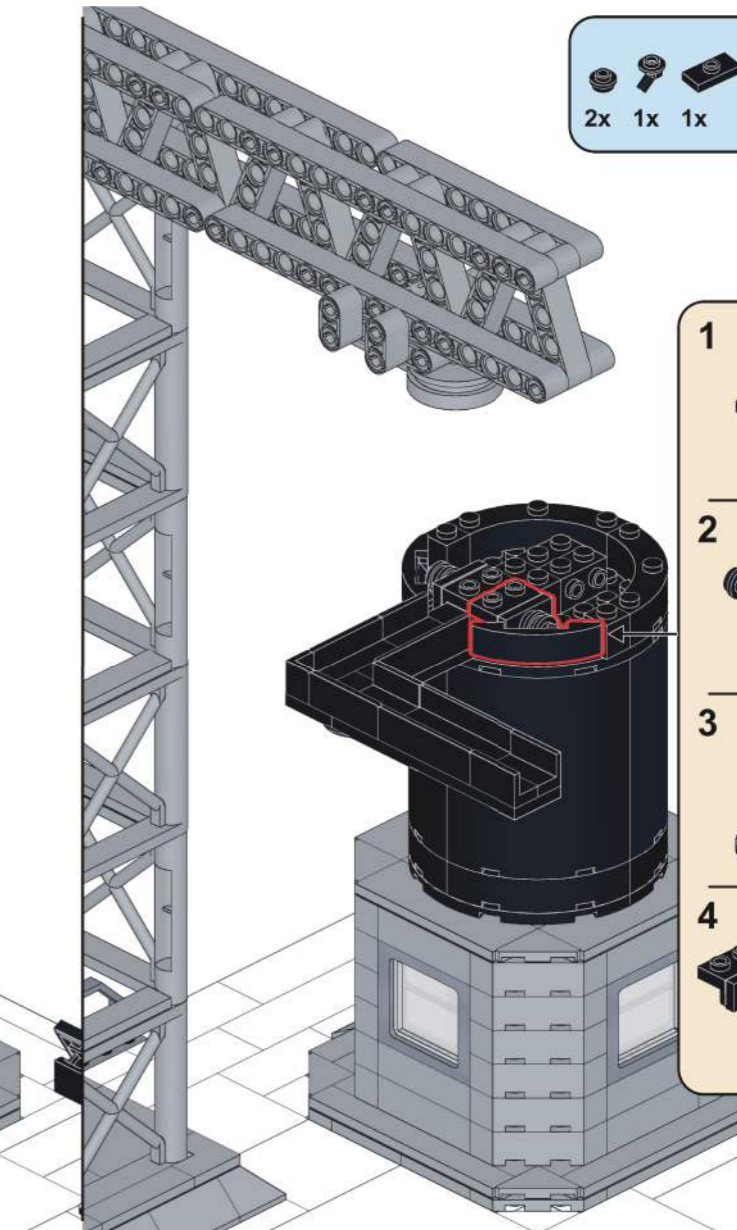
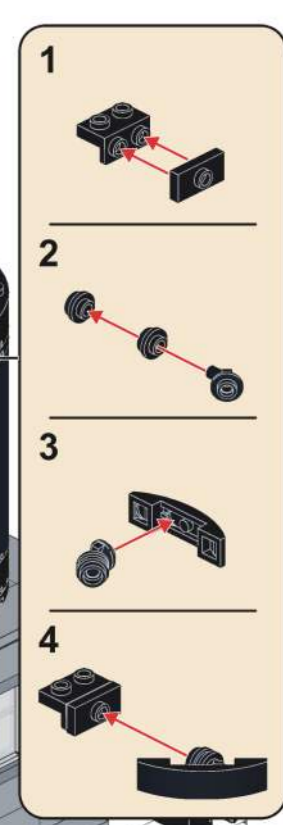

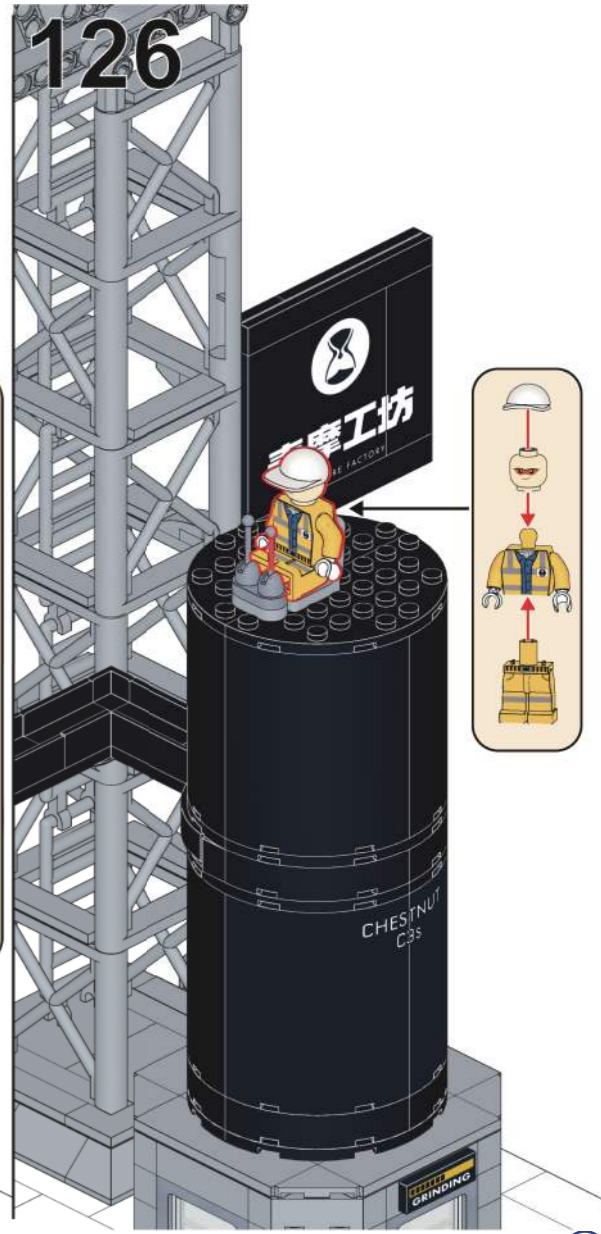
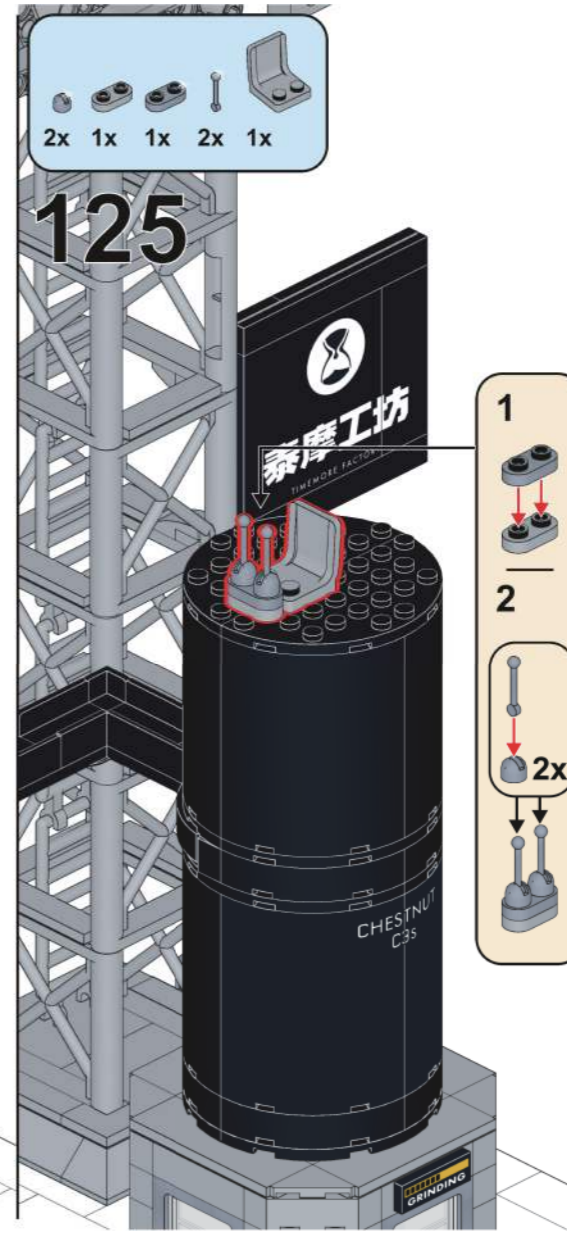
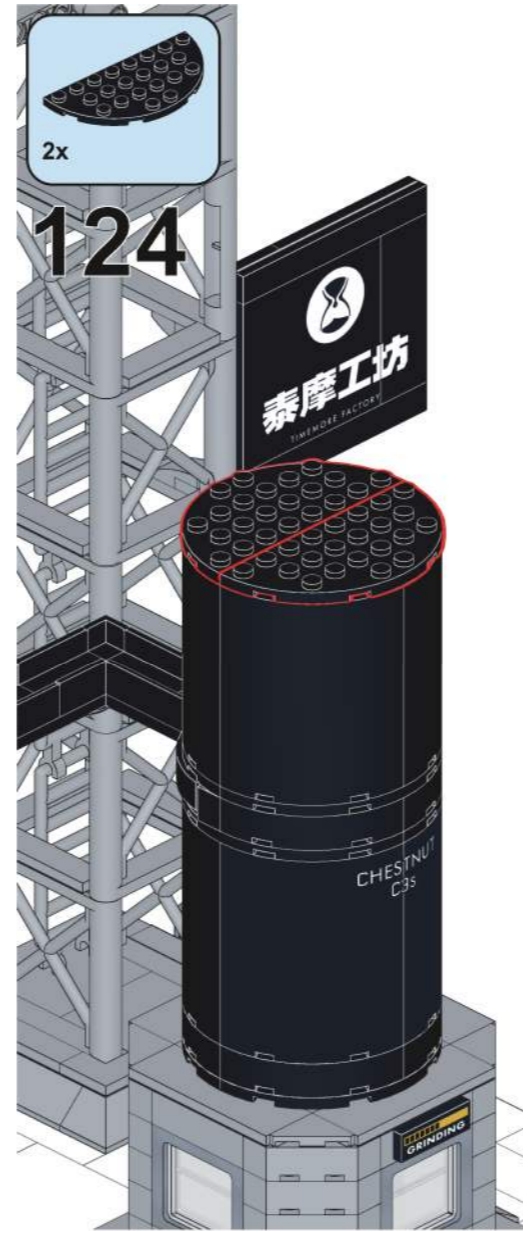
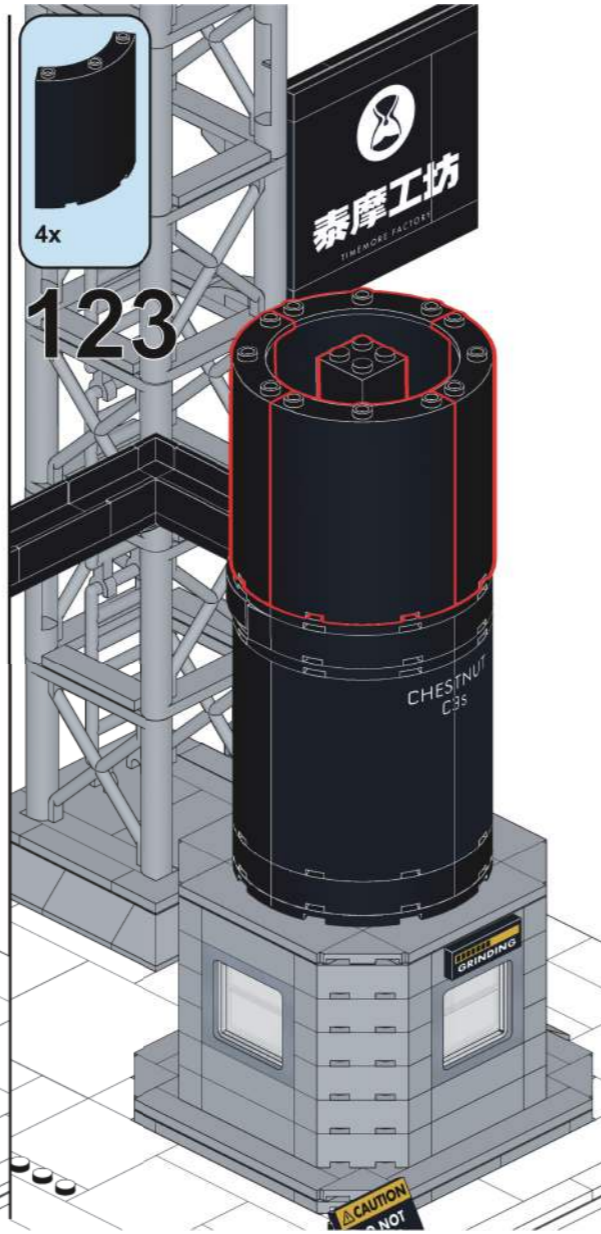
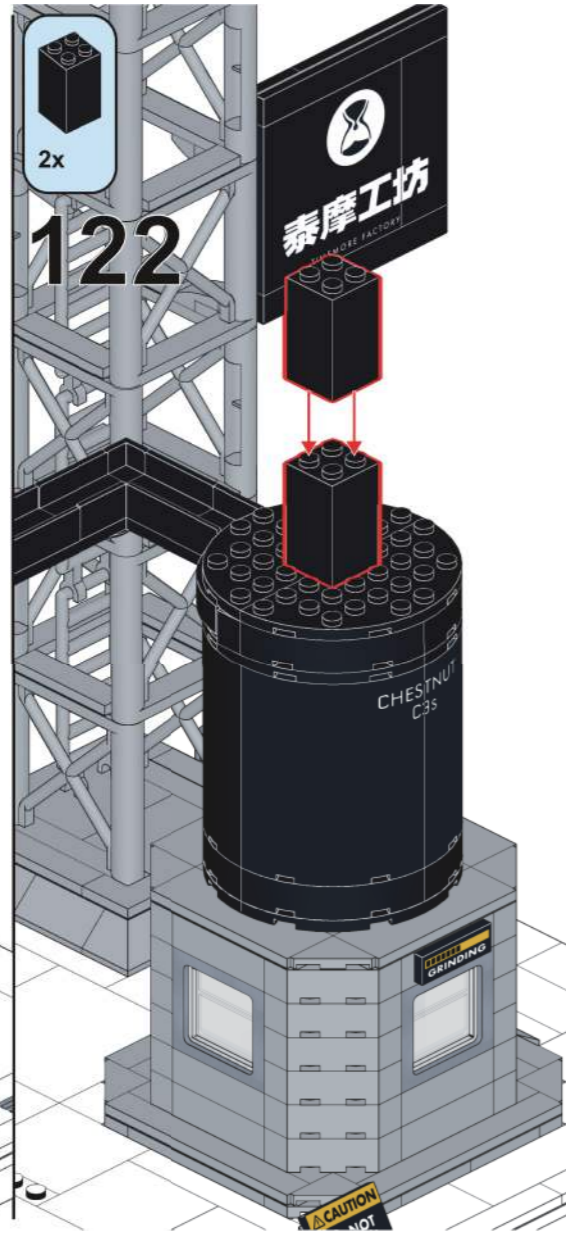
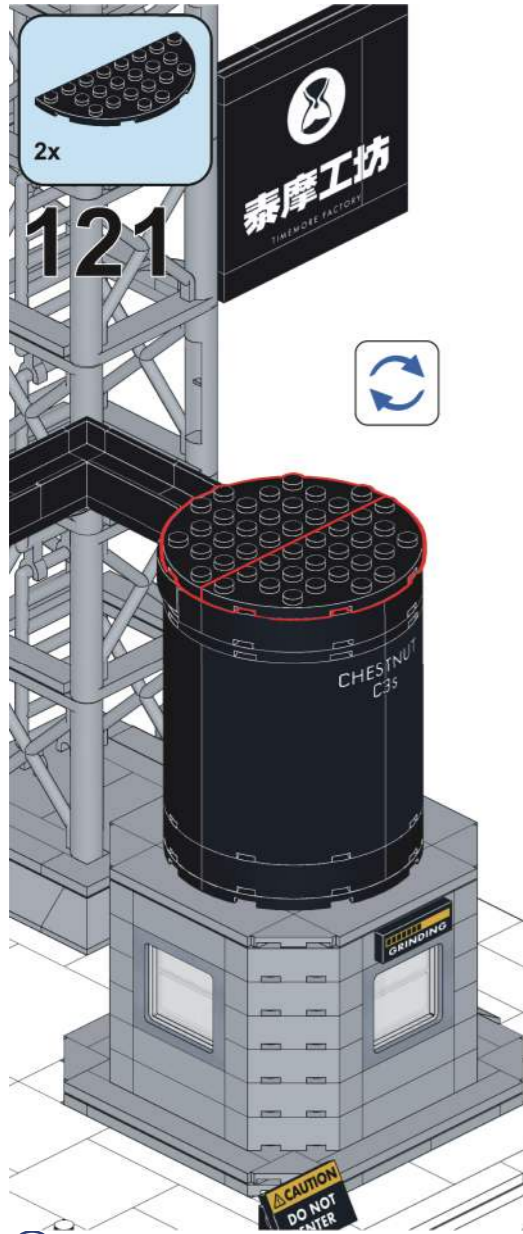



127

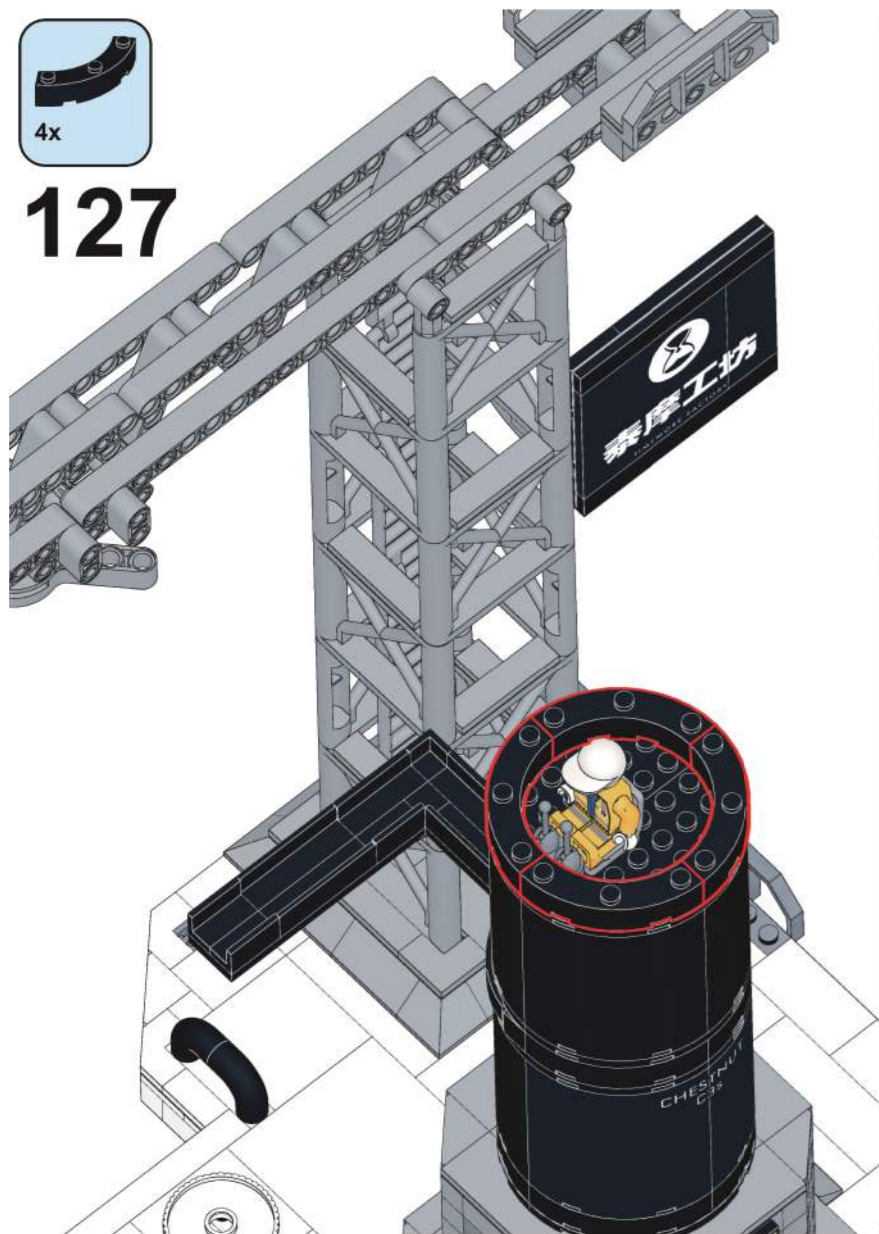

128

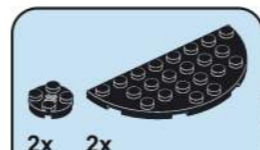
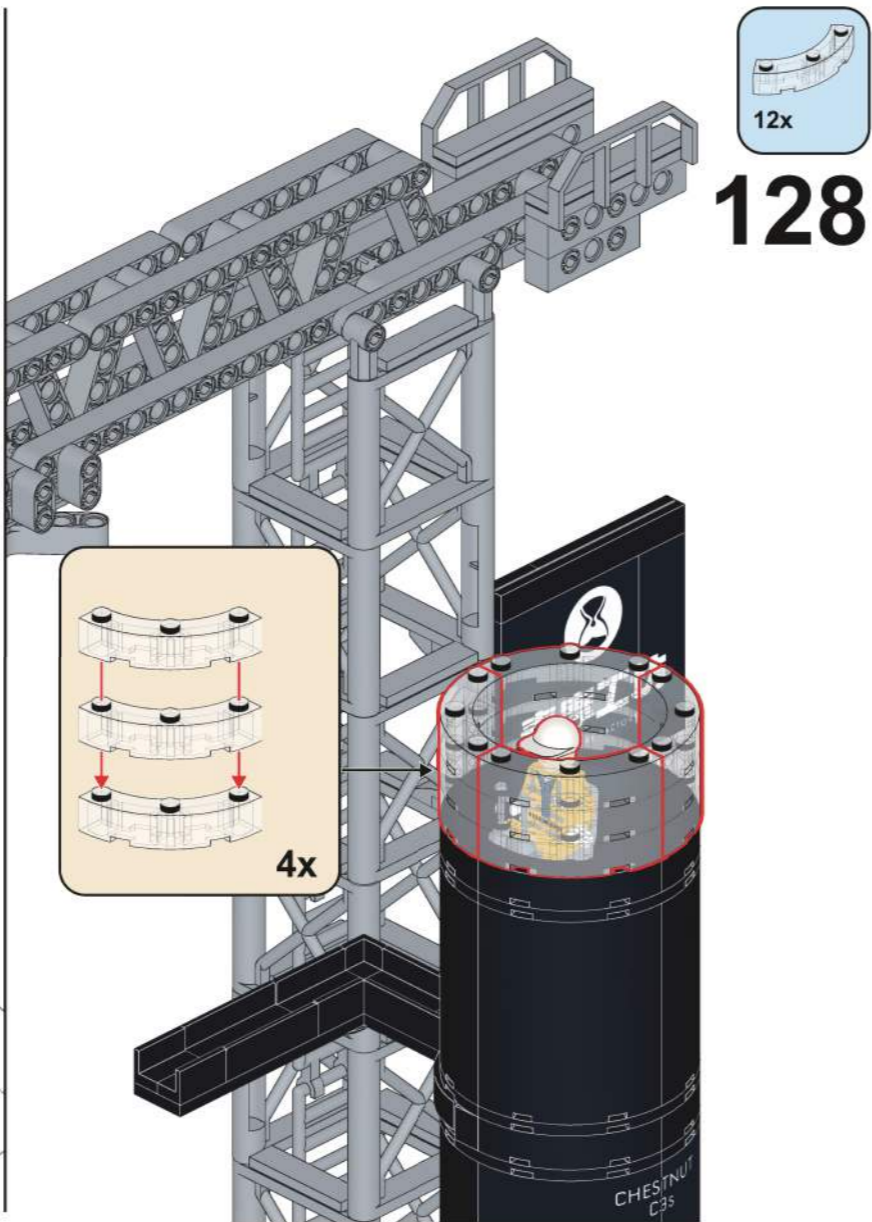

129

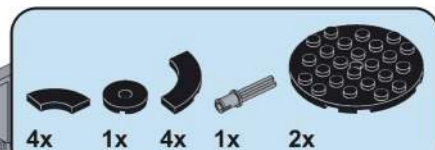
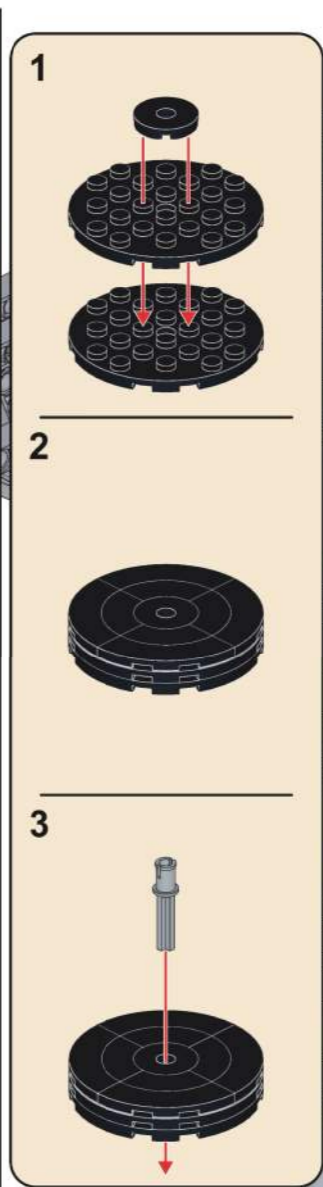
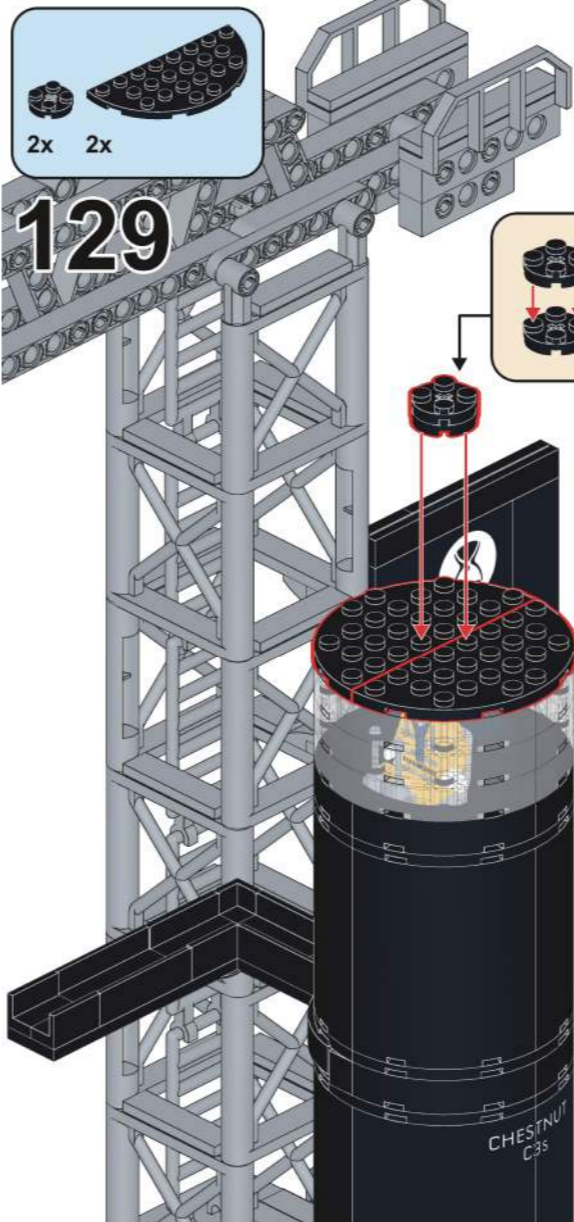

130

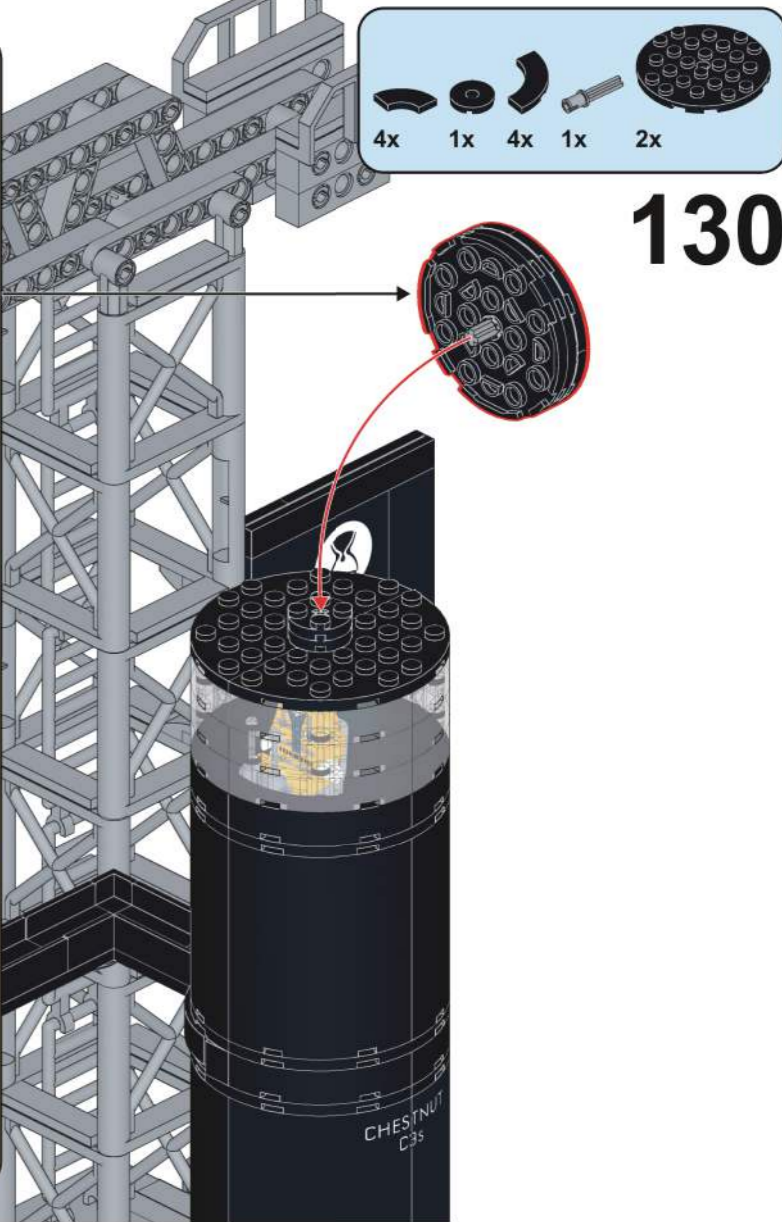

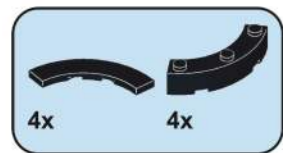

131

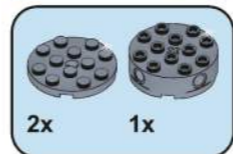
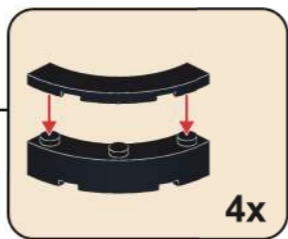

132

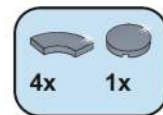
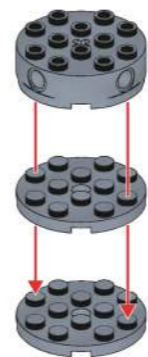

133

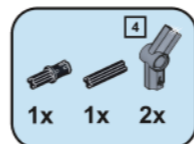
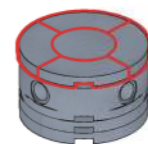

134

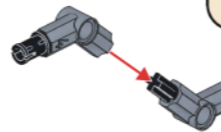
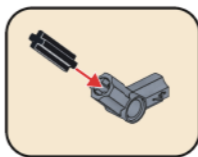
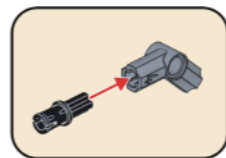
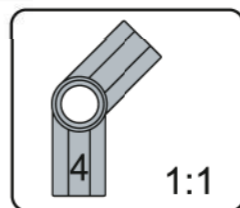

135

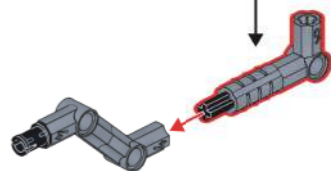
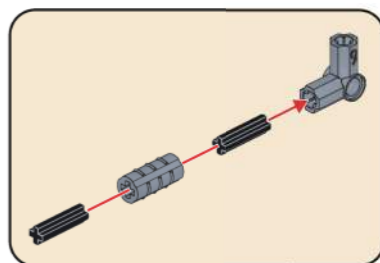

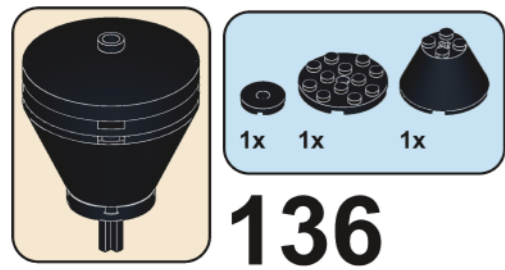

136

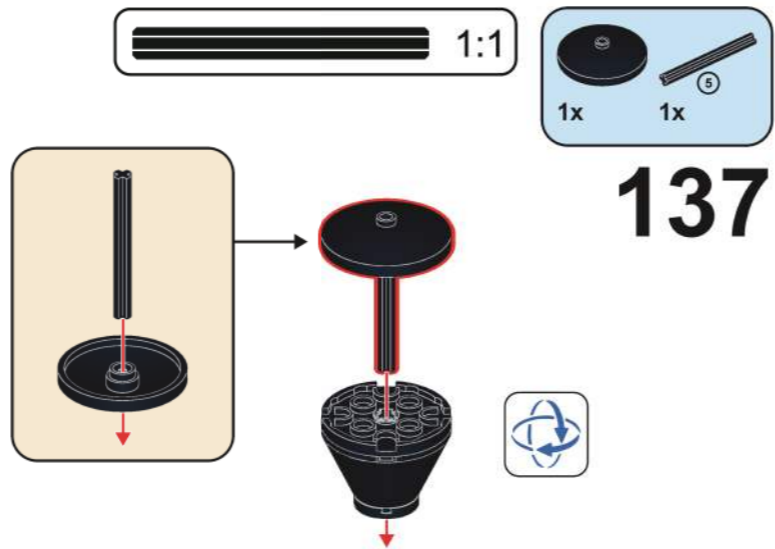
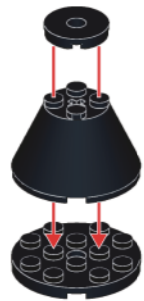

137

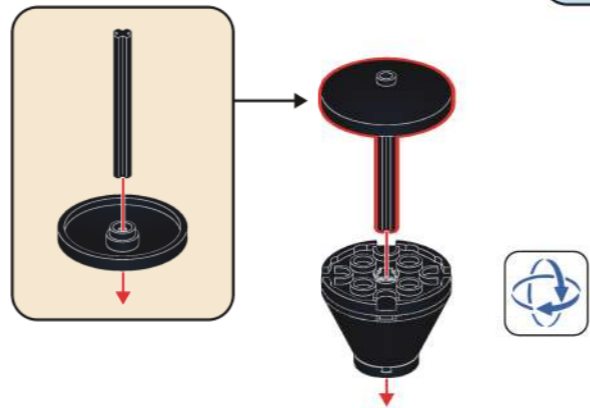

138



139

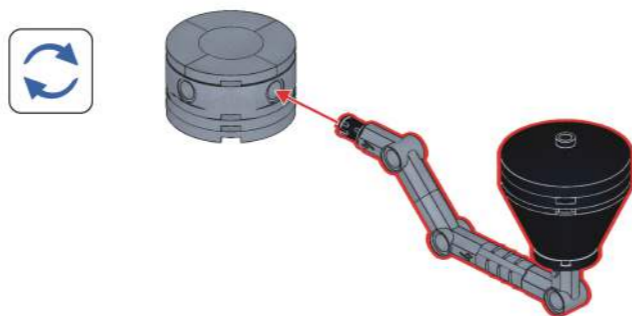

140

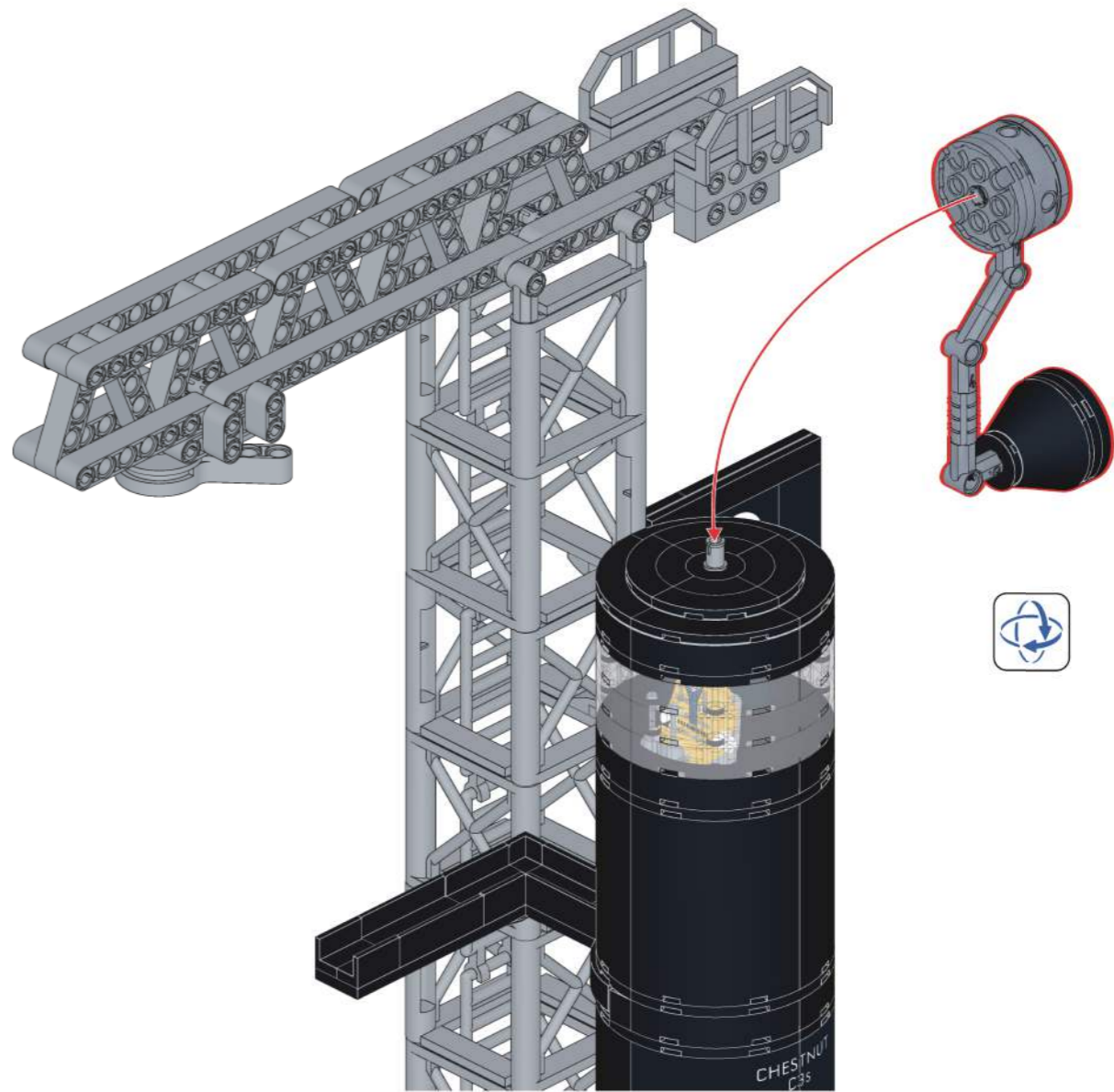



141

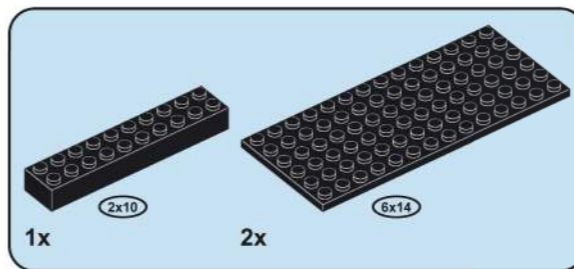
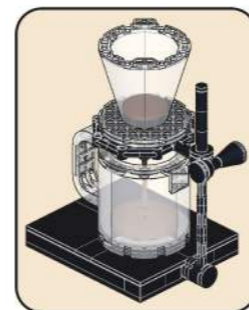
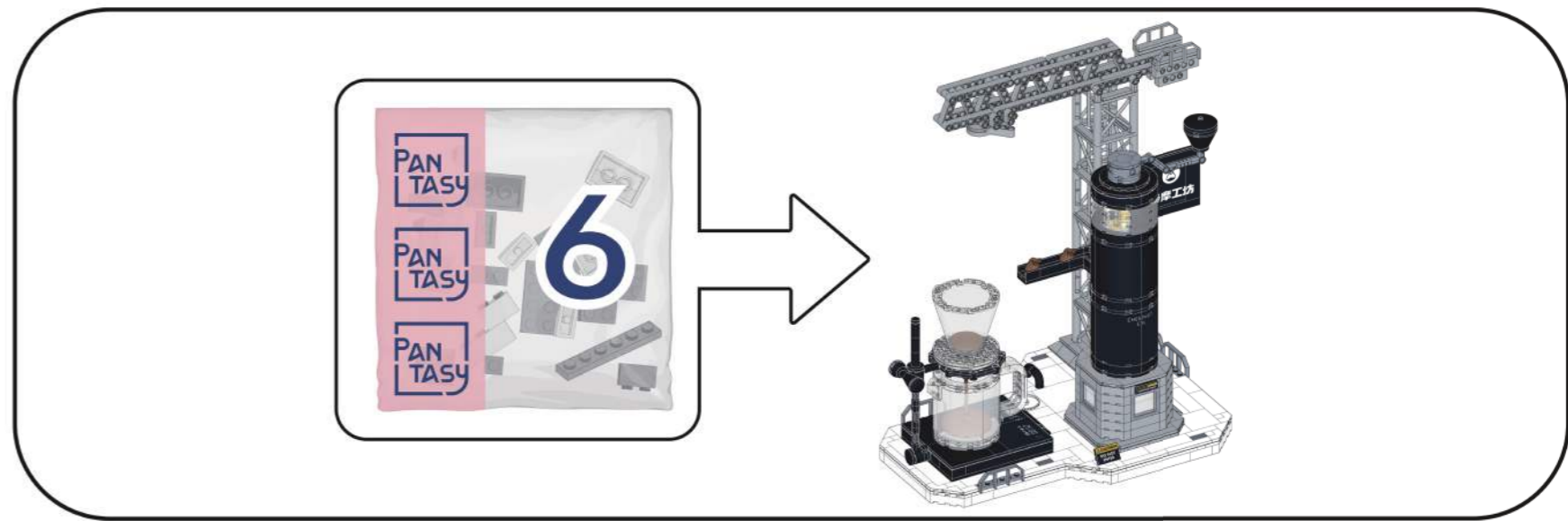

142

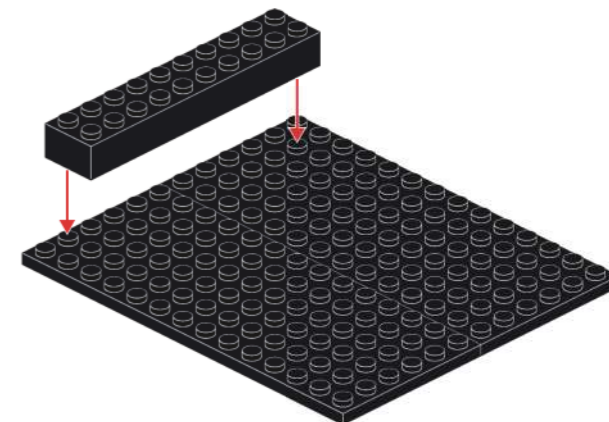

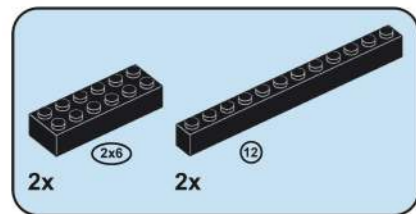

143

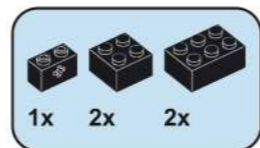
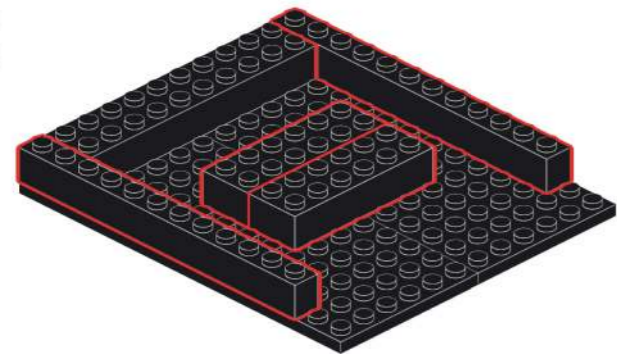

144

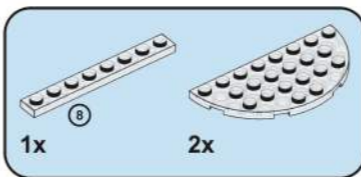
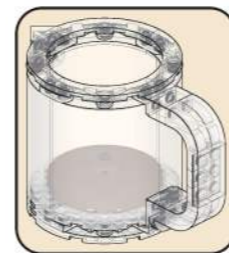
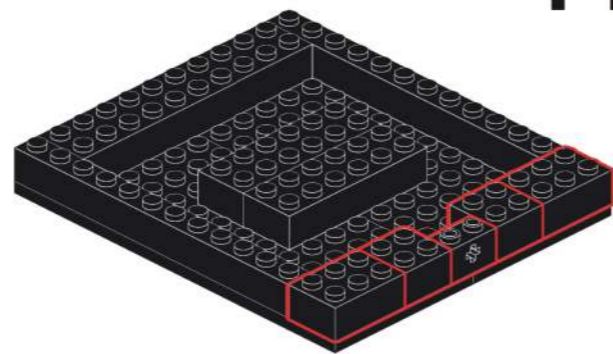

147

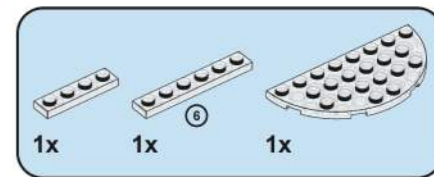
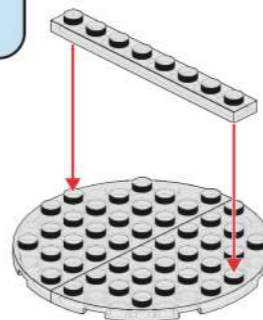

148

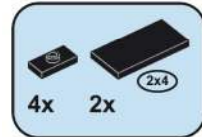
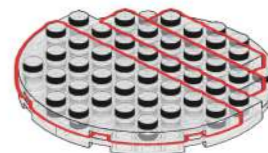

145

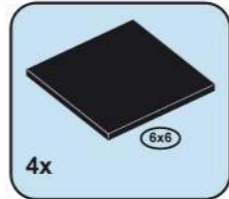
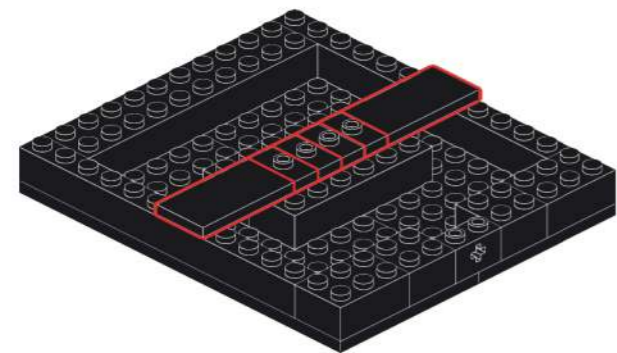

146

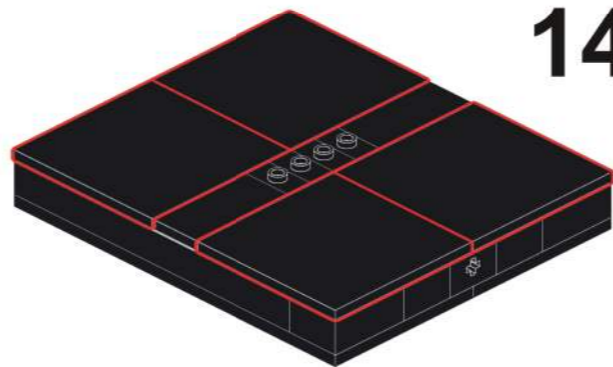

149

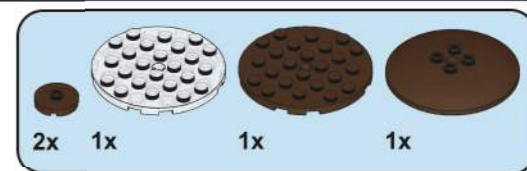
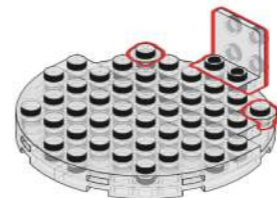

150

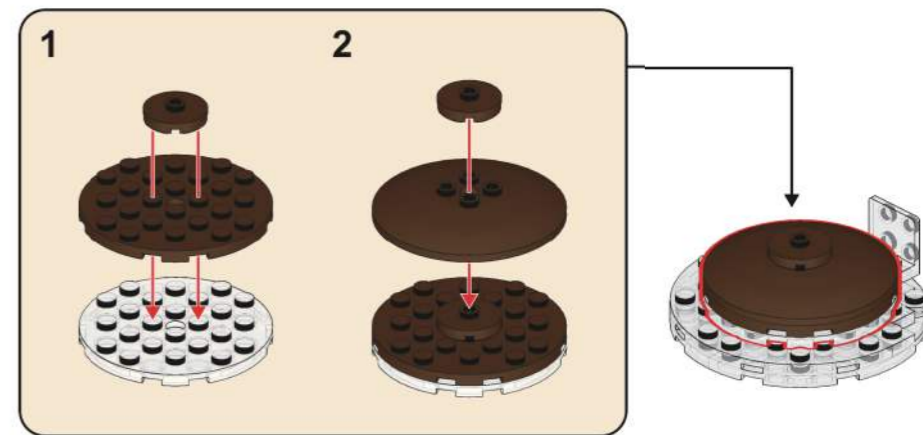



151

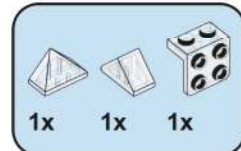

153

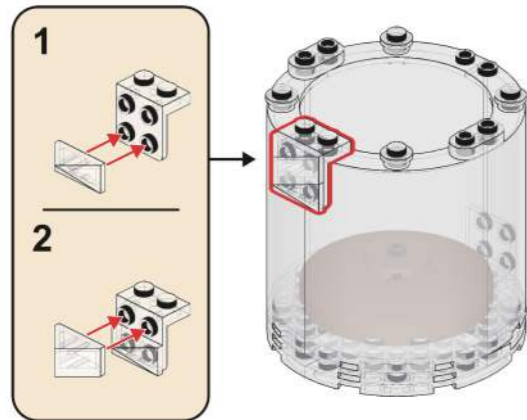

152

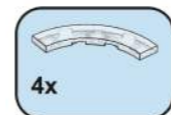

155

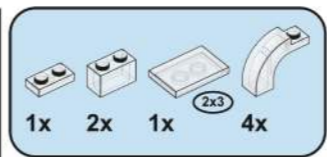

156

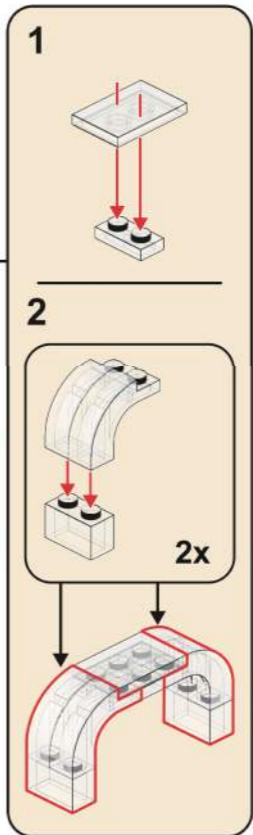

157

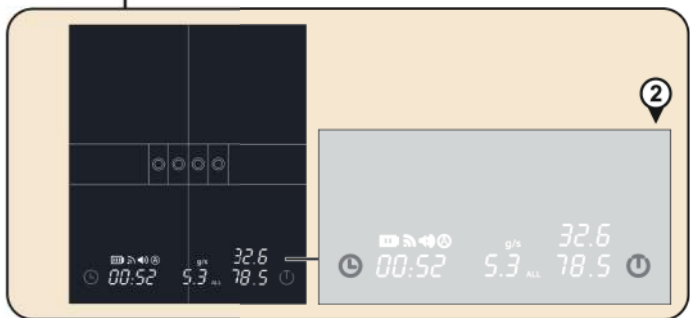
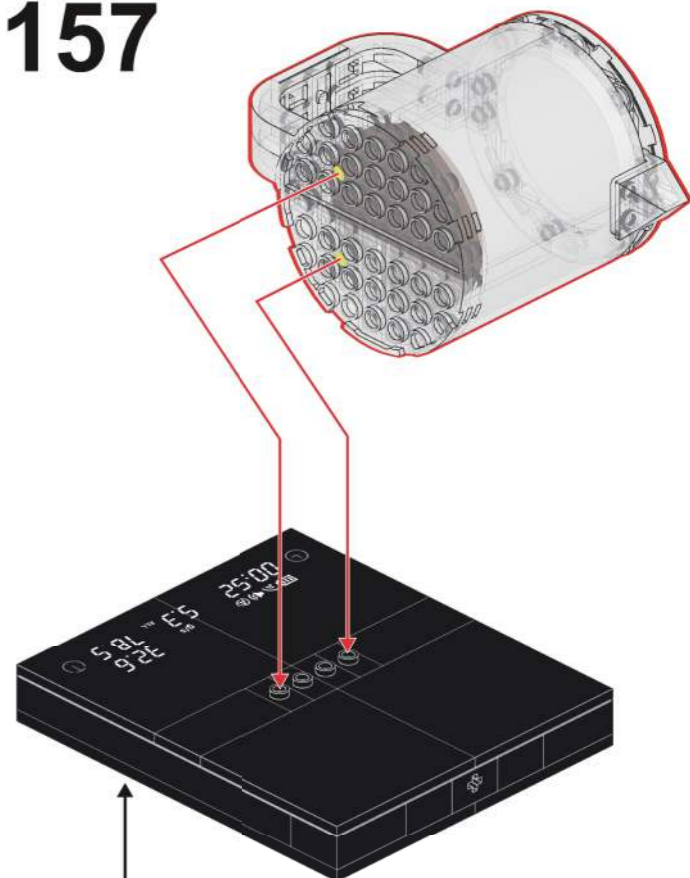

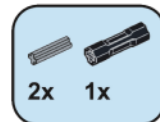
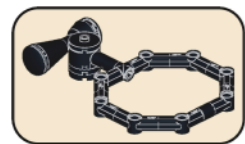

158

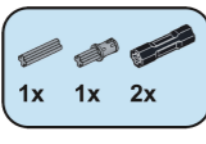

159

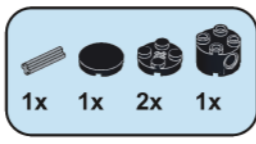
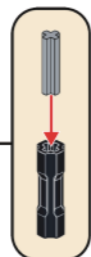
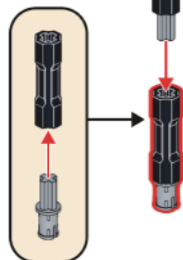

160

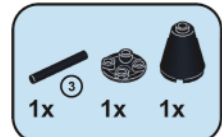
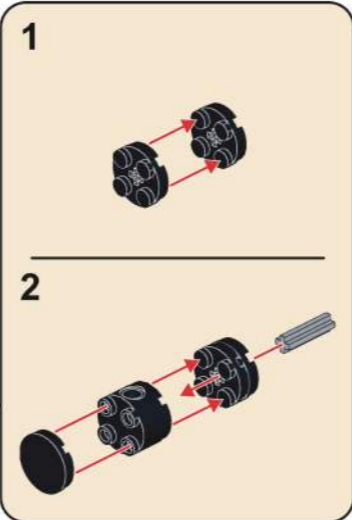
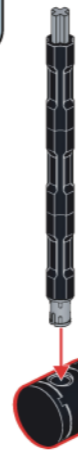

161

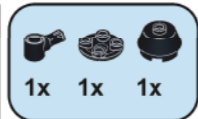

162

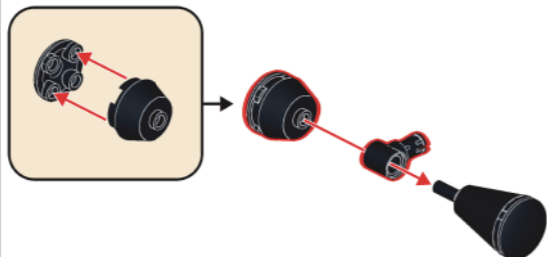

163

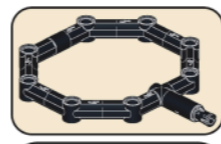
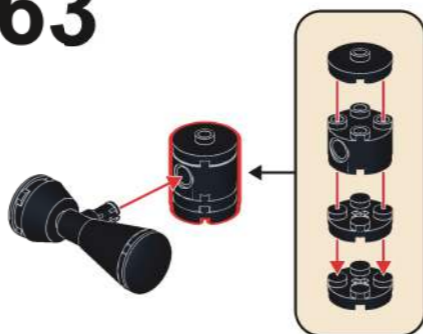

164

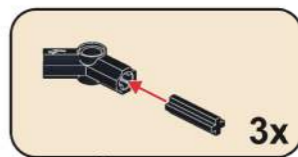

165

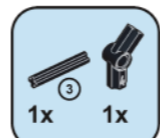
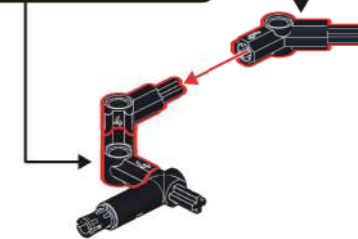

166

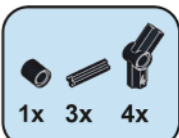
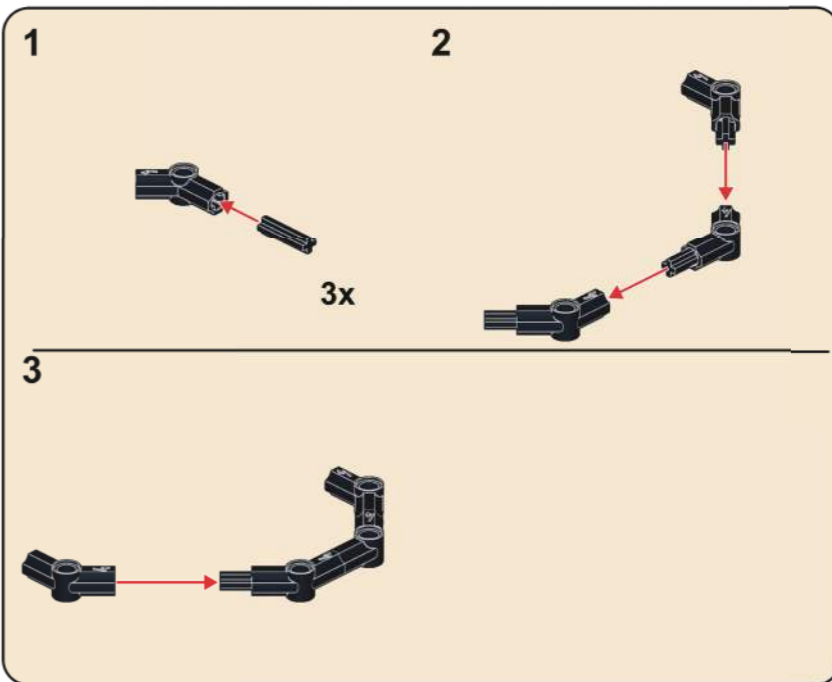
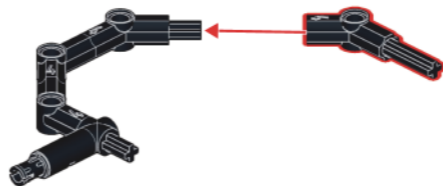
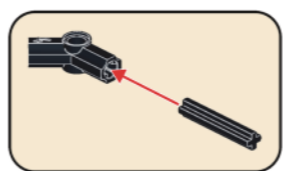

167

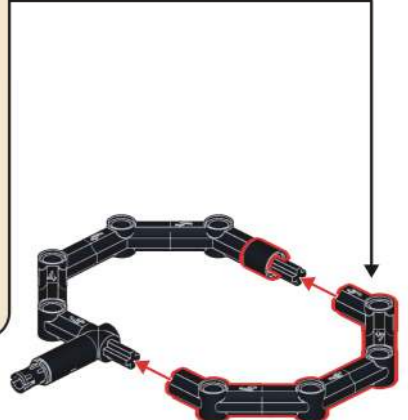

168



169

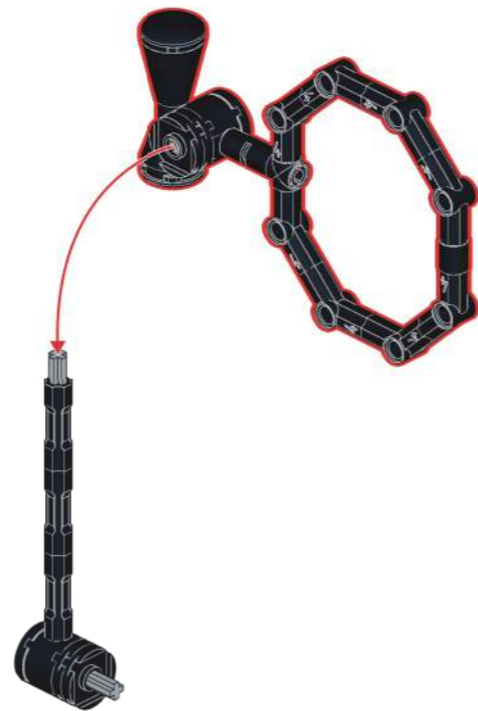

170

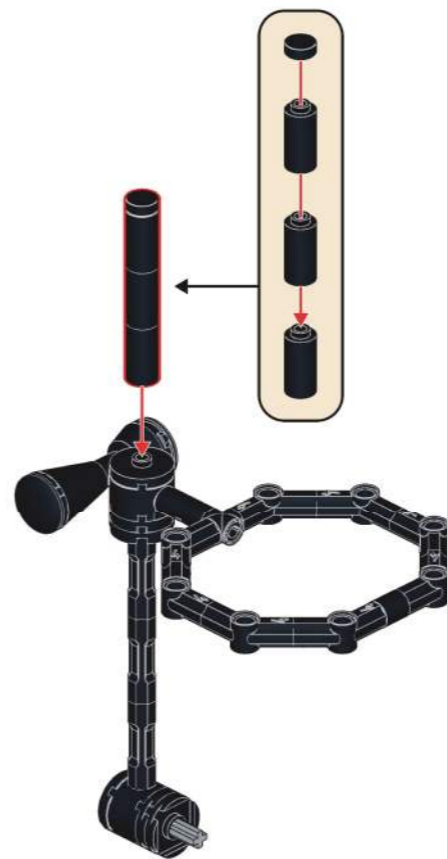

171



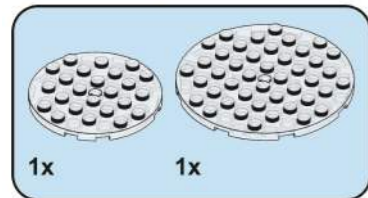

172

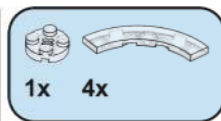
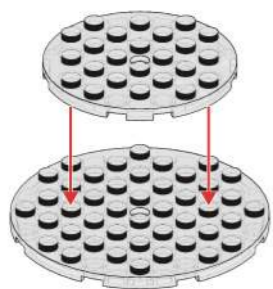

173

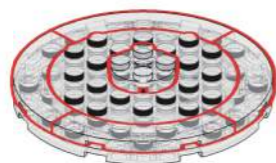

174

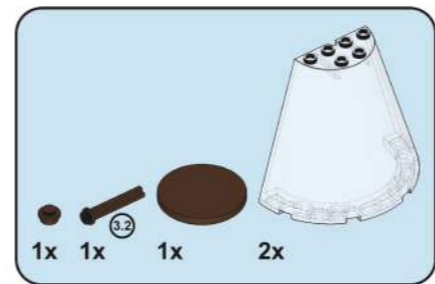
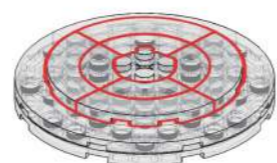

175

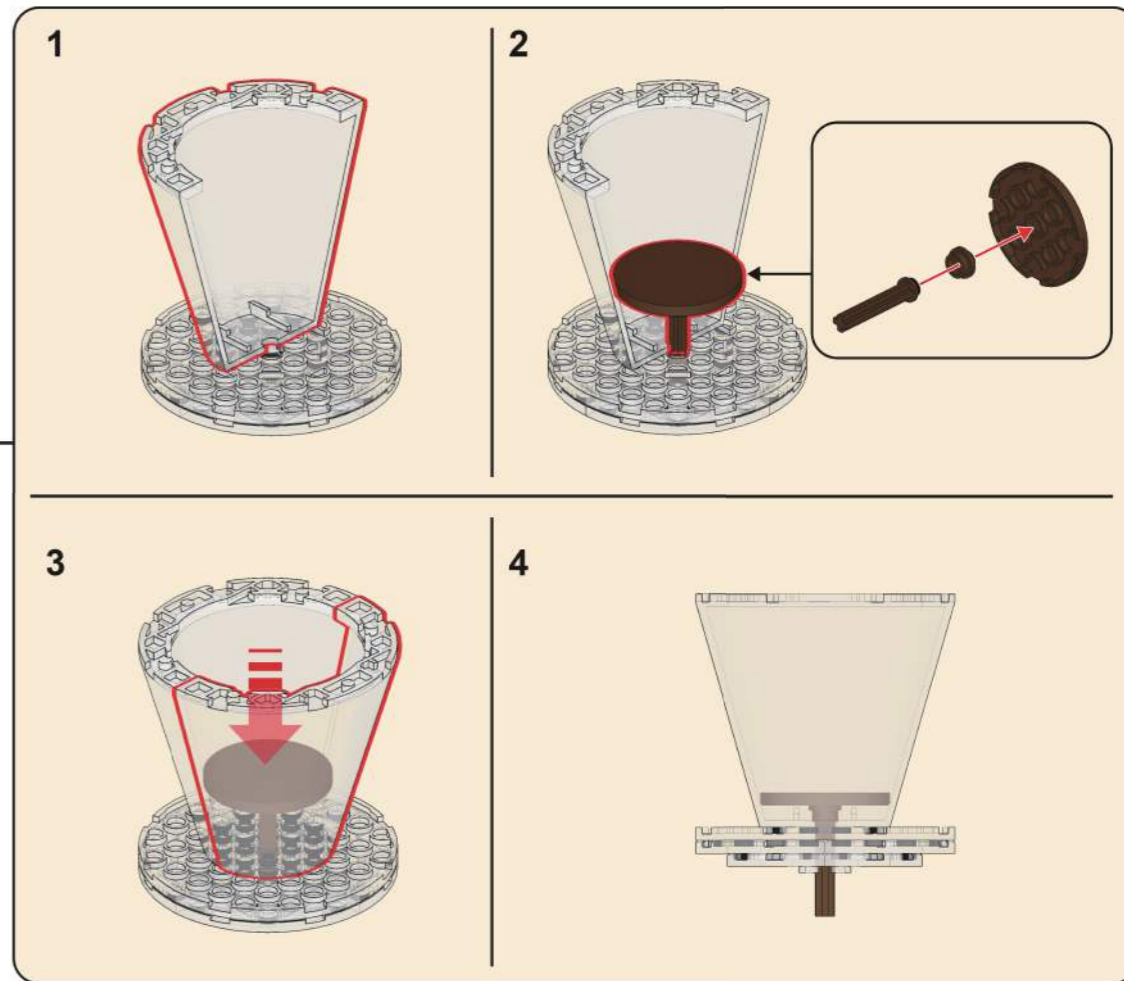
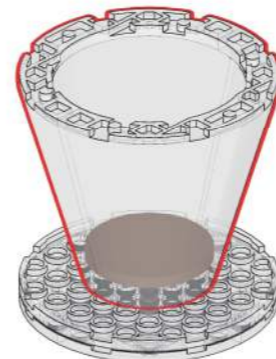



176

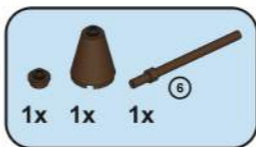
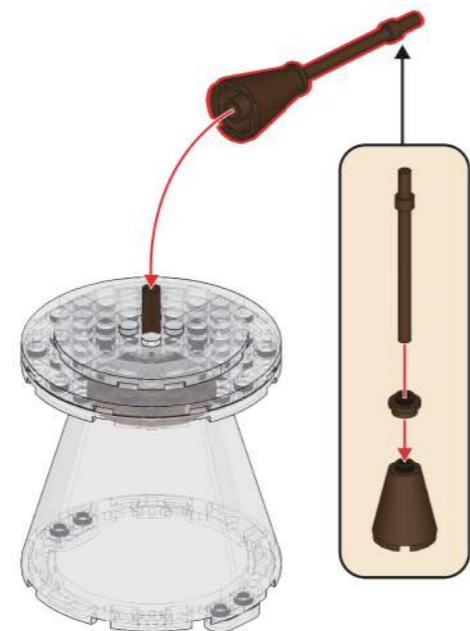
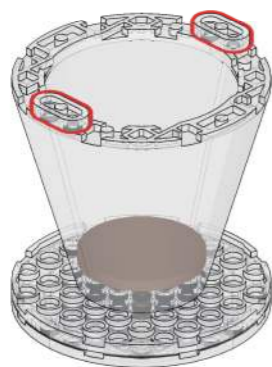

177

178

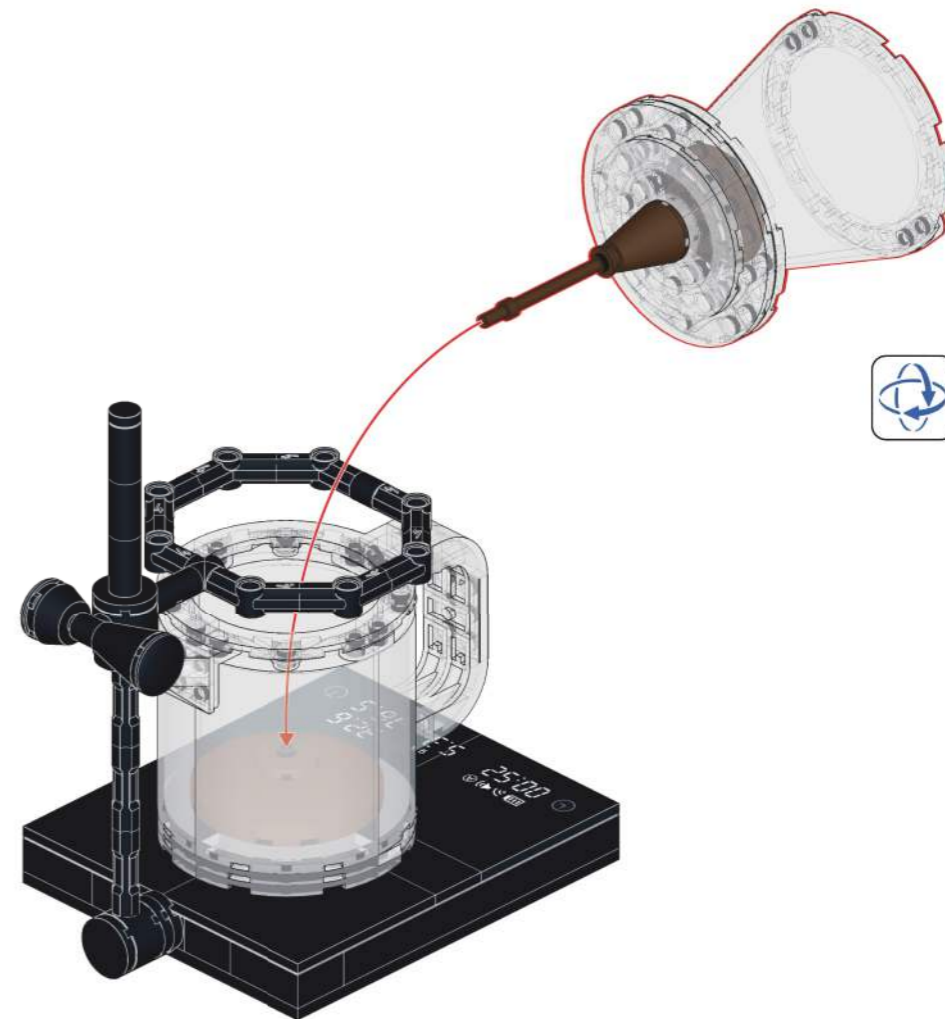

179

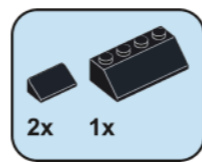
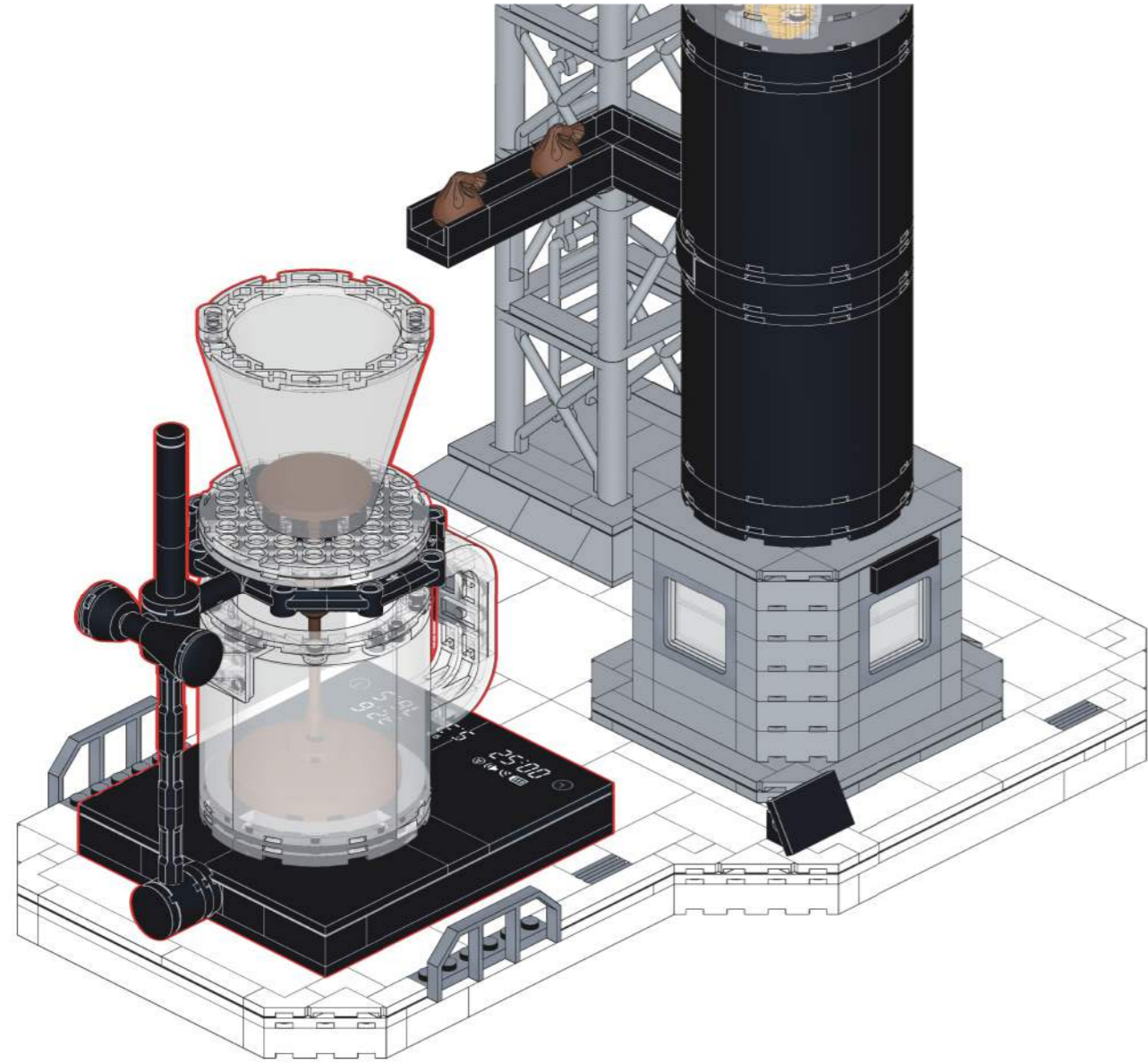

180

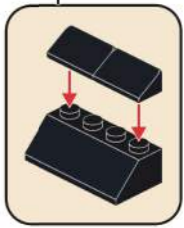
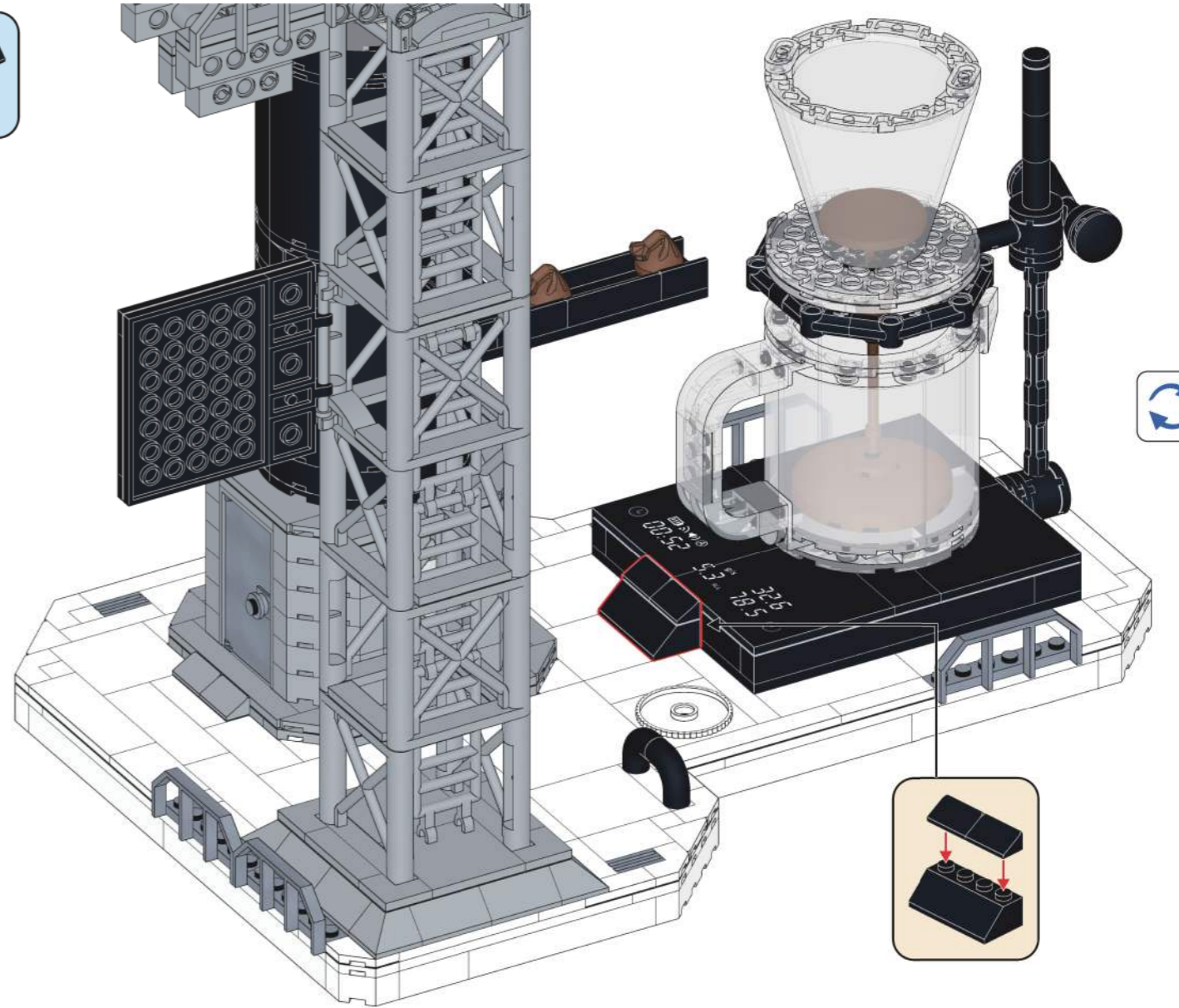

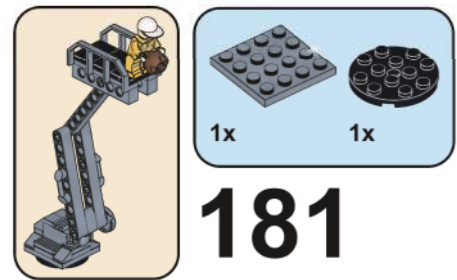
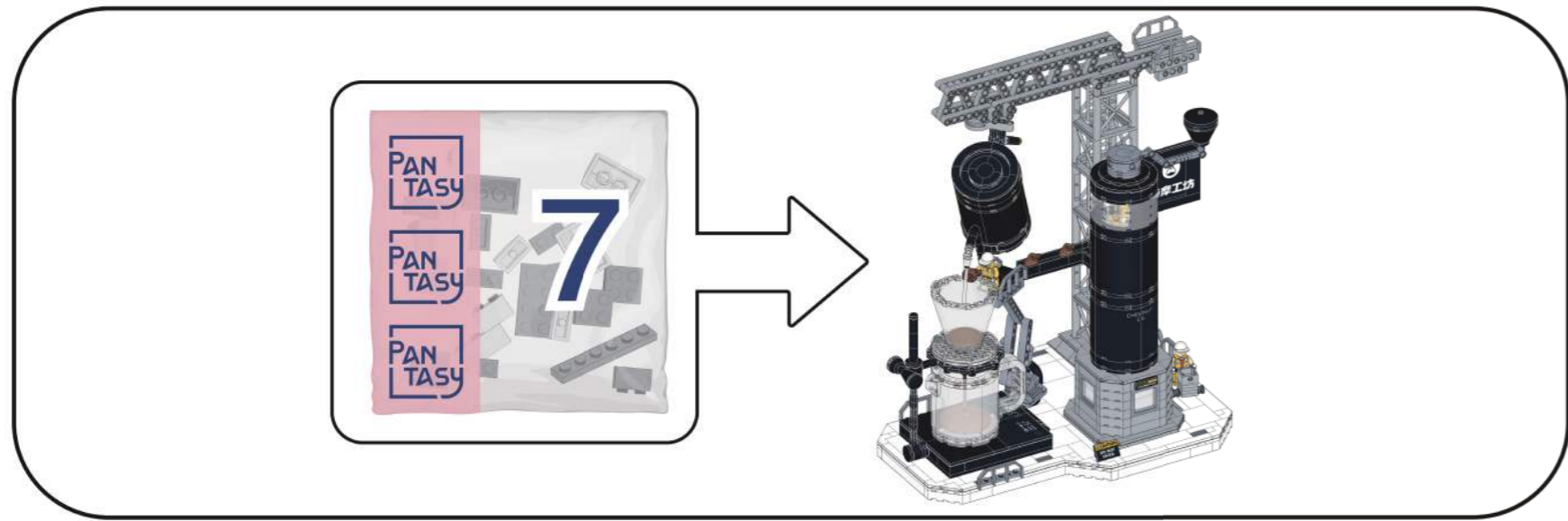

181

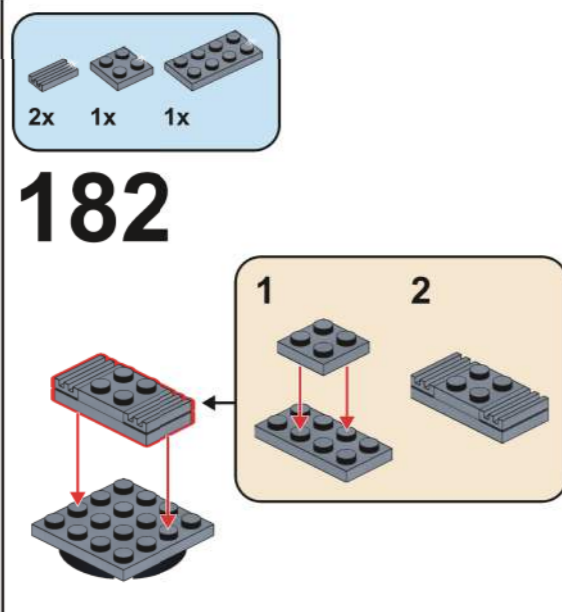

182

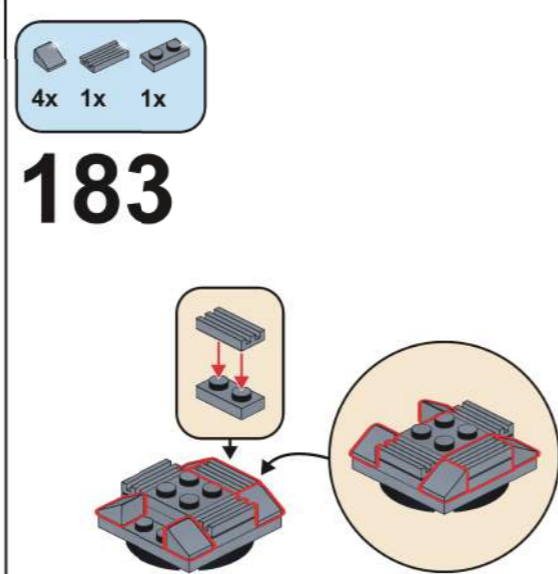

183

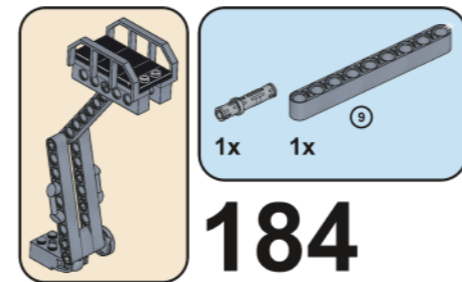

184

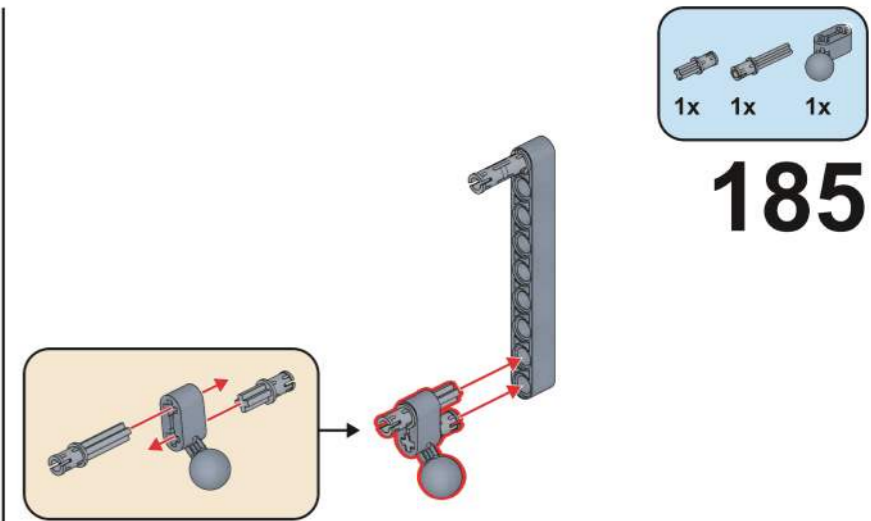

185

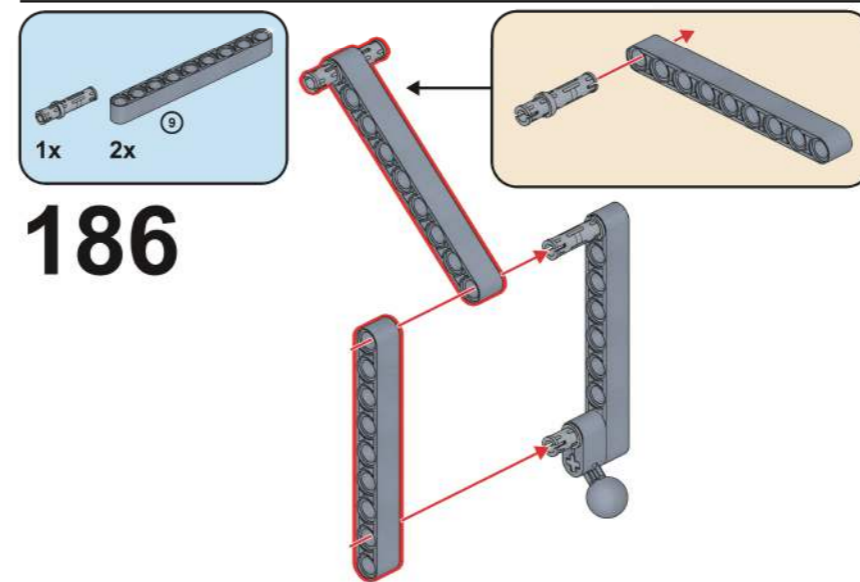

186



187

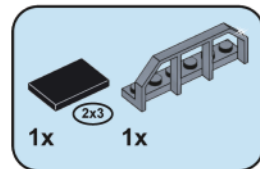
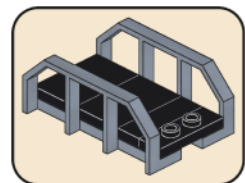

188

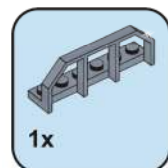
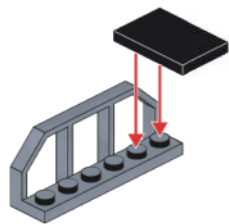

190

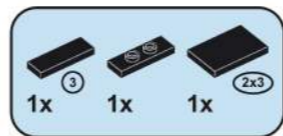
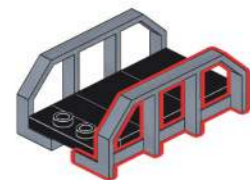

189



191

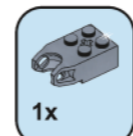
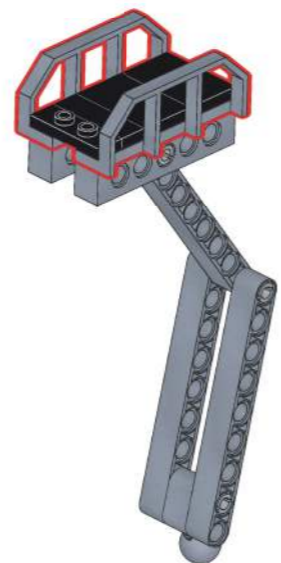

192

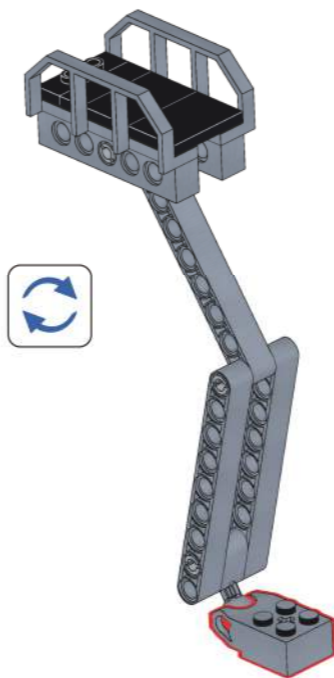

193

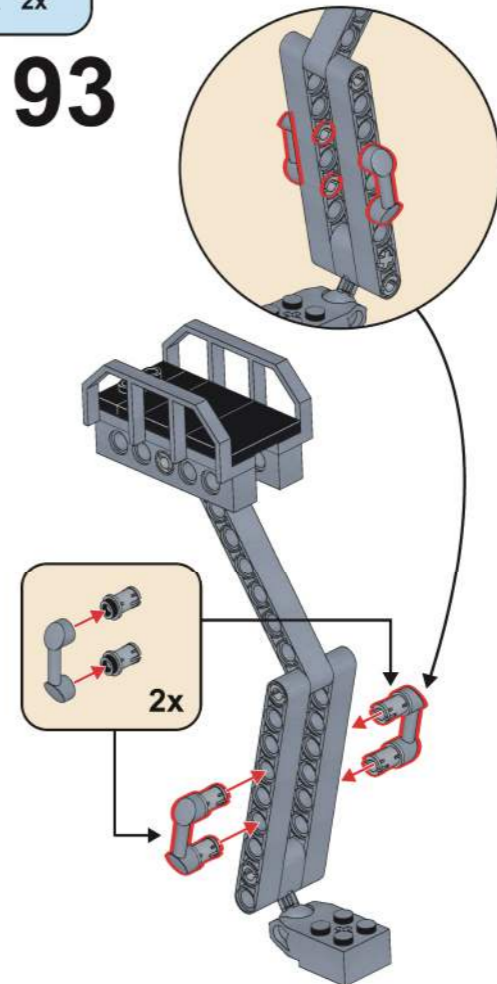

194

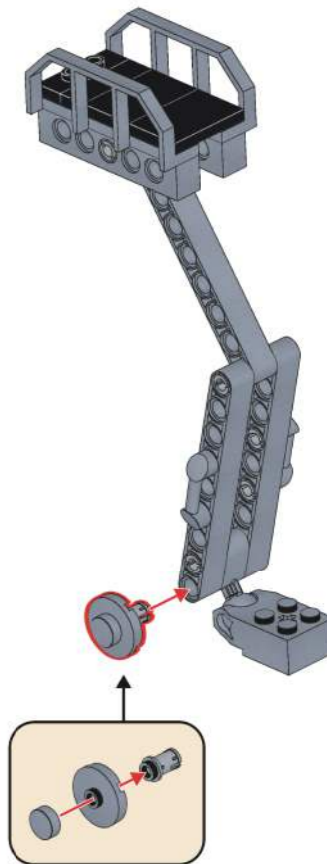

195

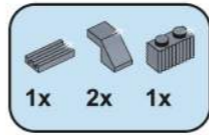
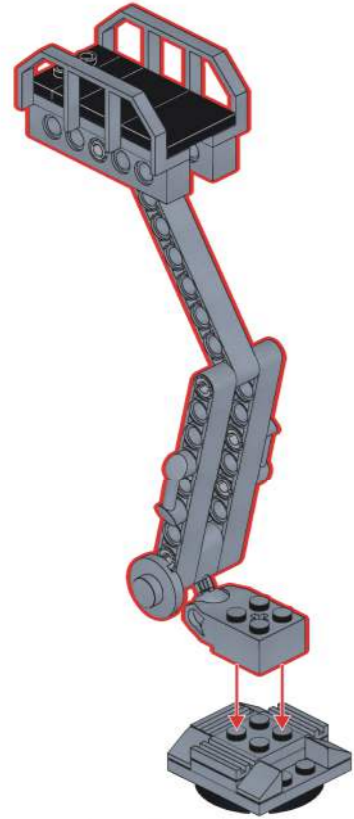

196

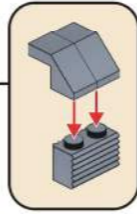

197

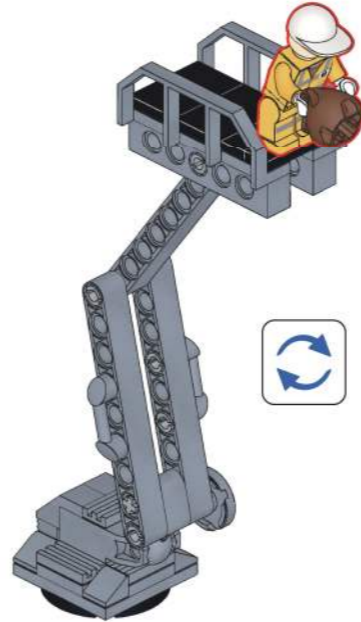
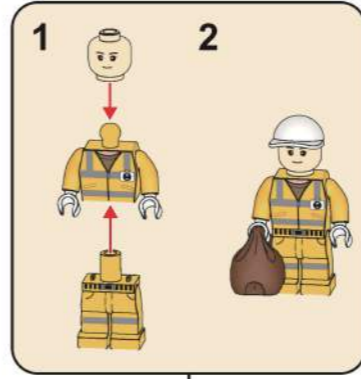

198

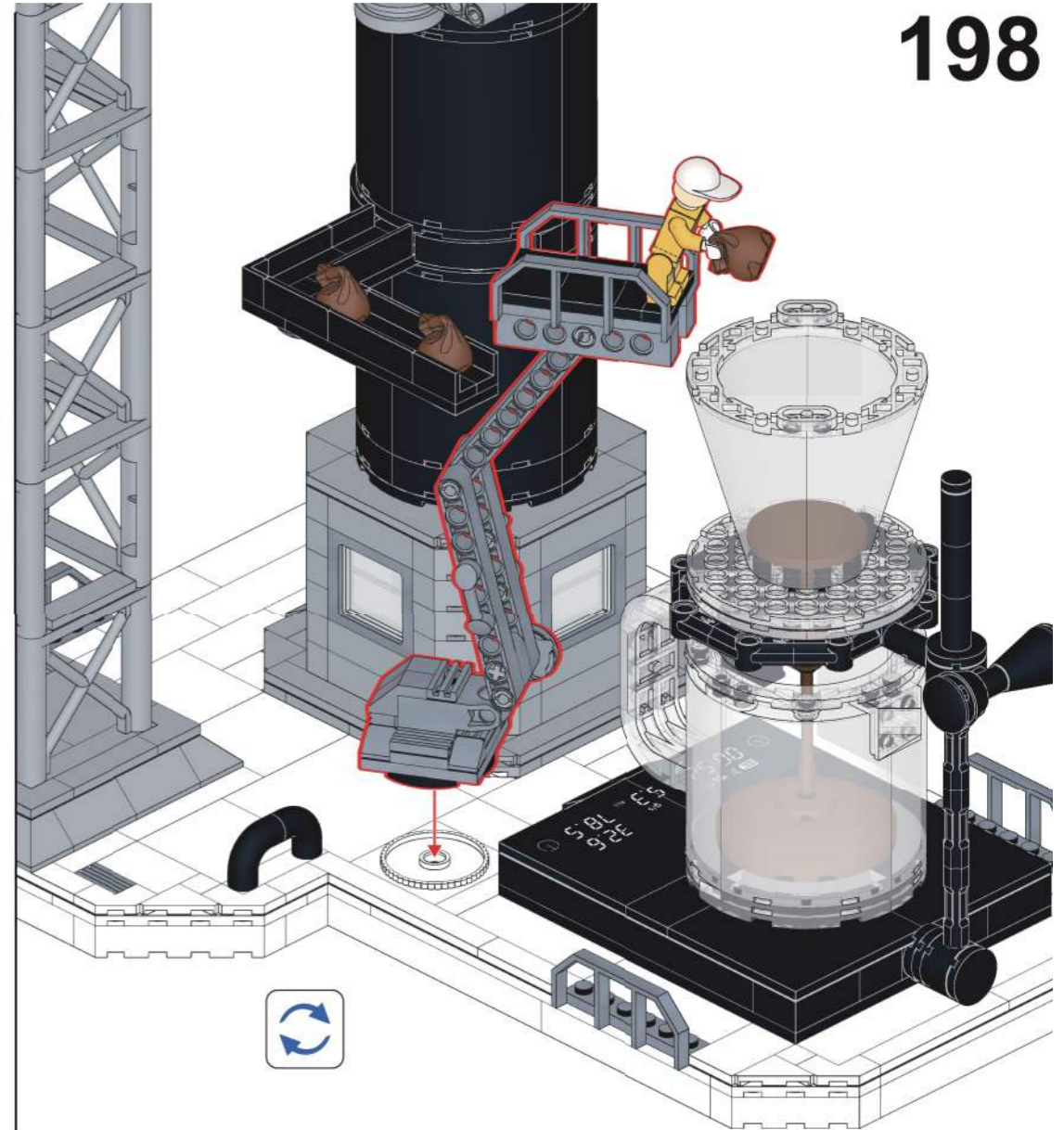

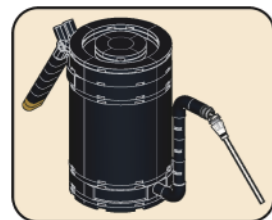

199

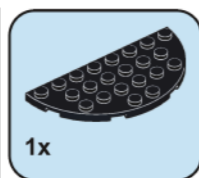
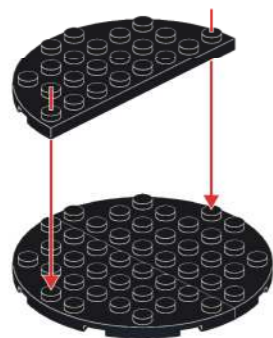

200

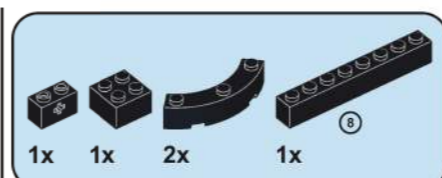

201

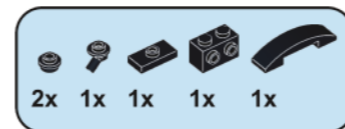
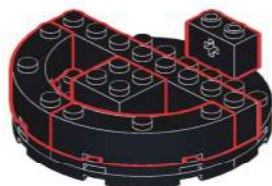

202

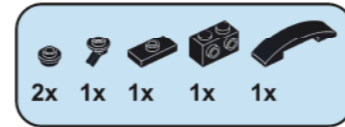
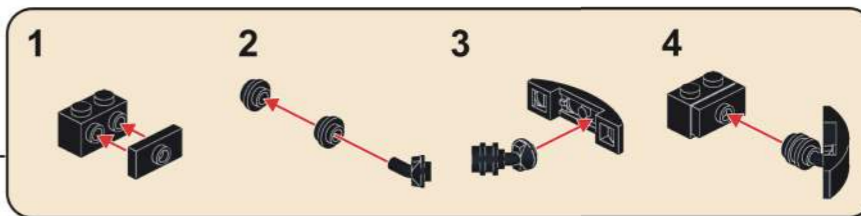
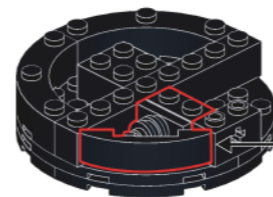

203

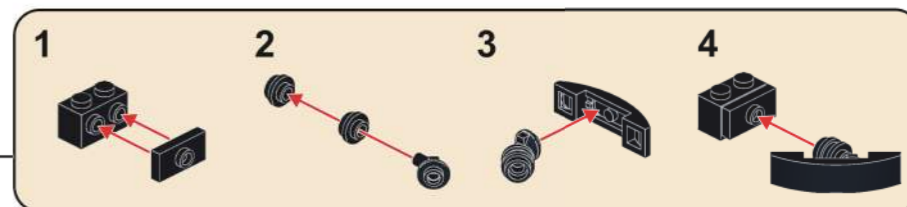
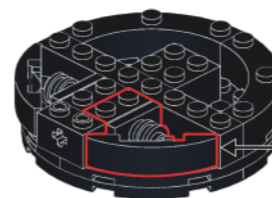

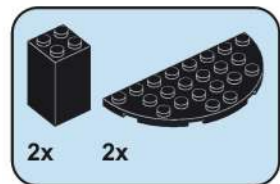

204

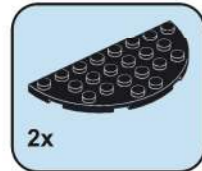
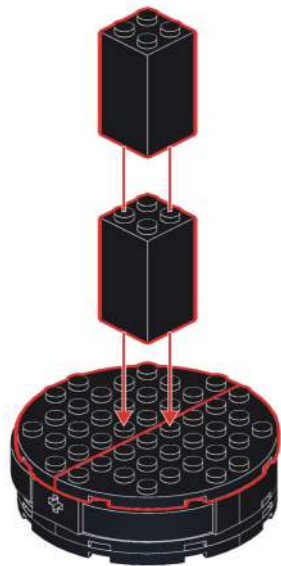

206



205

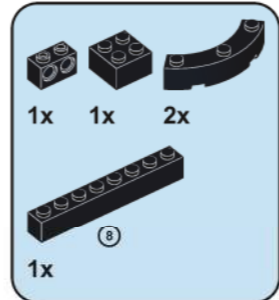

207

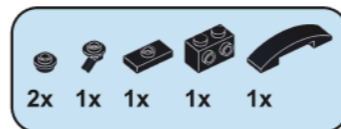
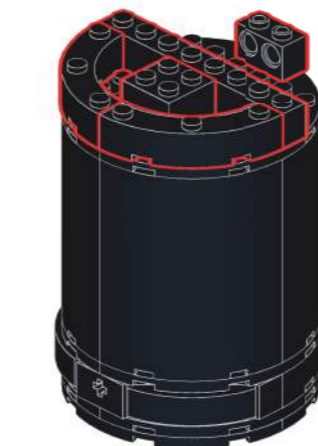

208

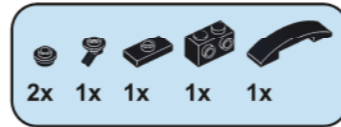
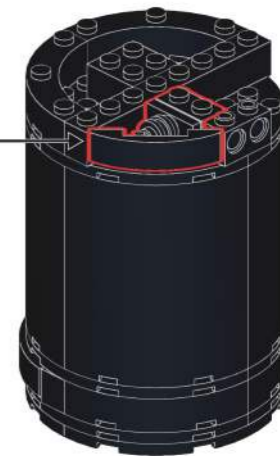
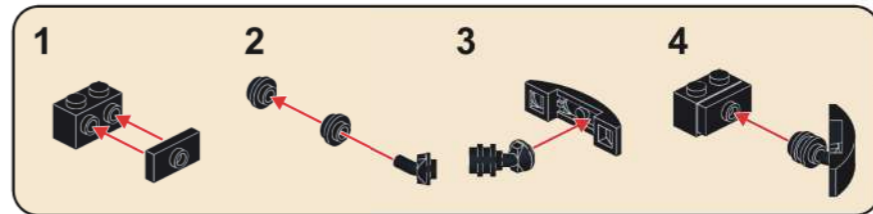

209

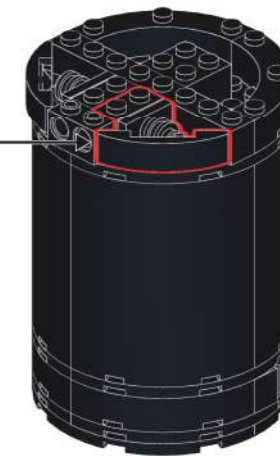
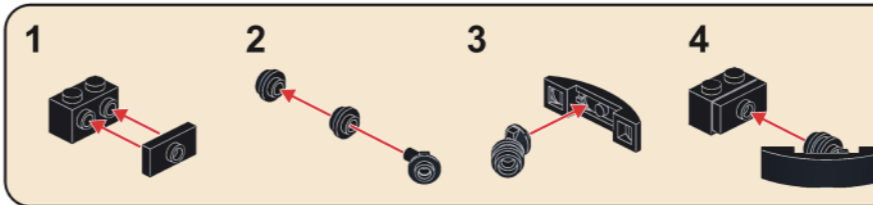

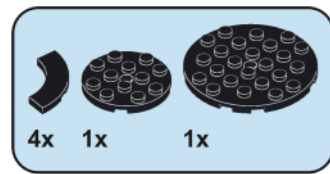

210

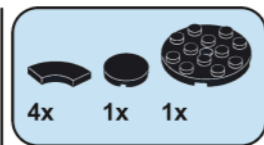
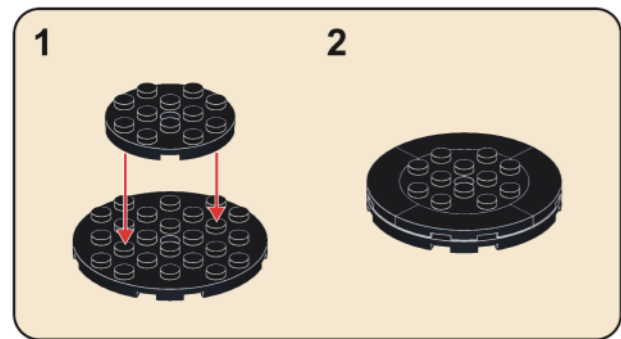

211

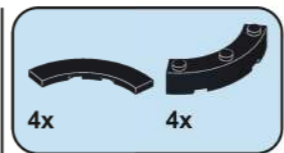
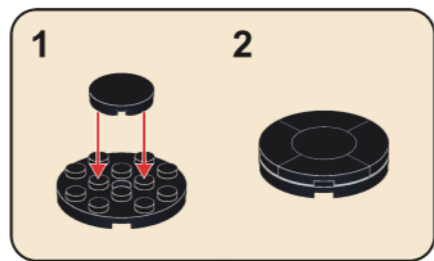

212

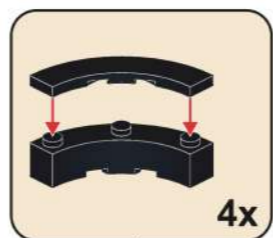

213



216

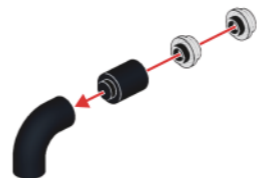

214

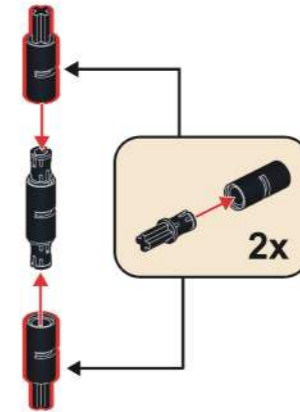

215

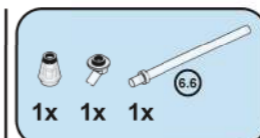

217

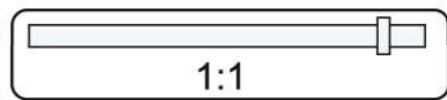
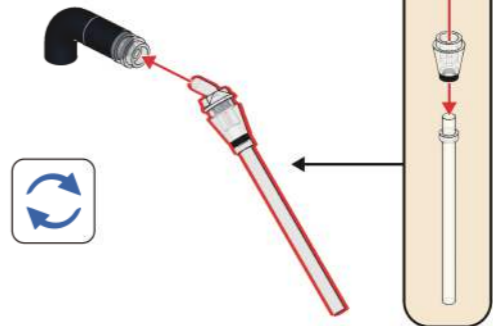

218



1x

219

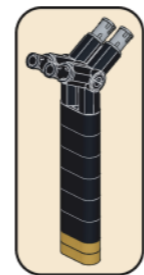

1x 2x

220

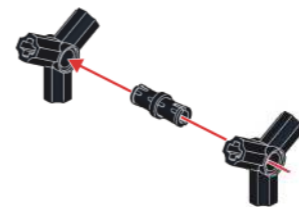

2x 2x

222



1:1

2x 6x 2x

221

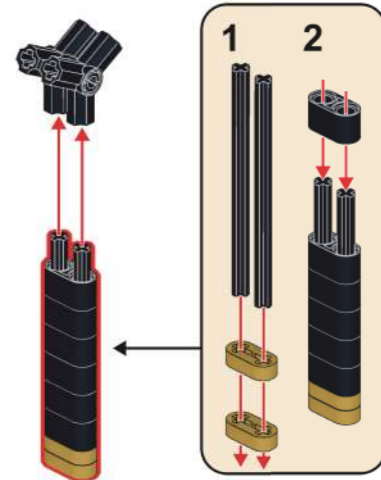

223

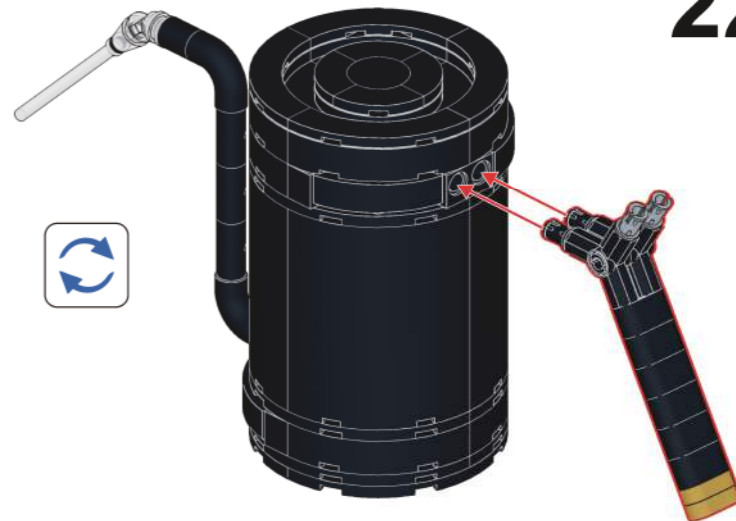

224

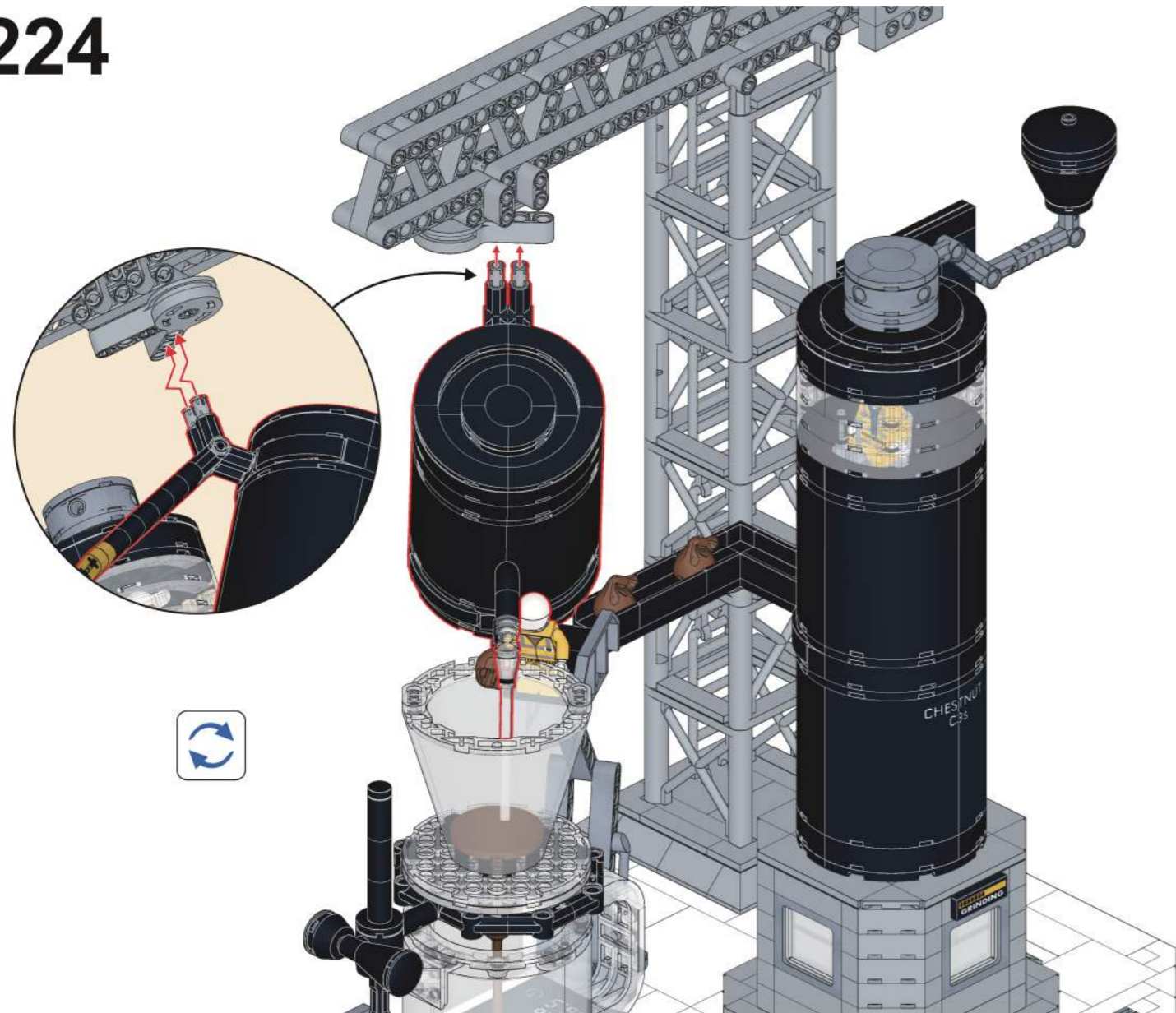

- 2x
- 1x
- 1x
- 1x
- 2x
- 1x
- 1x

225

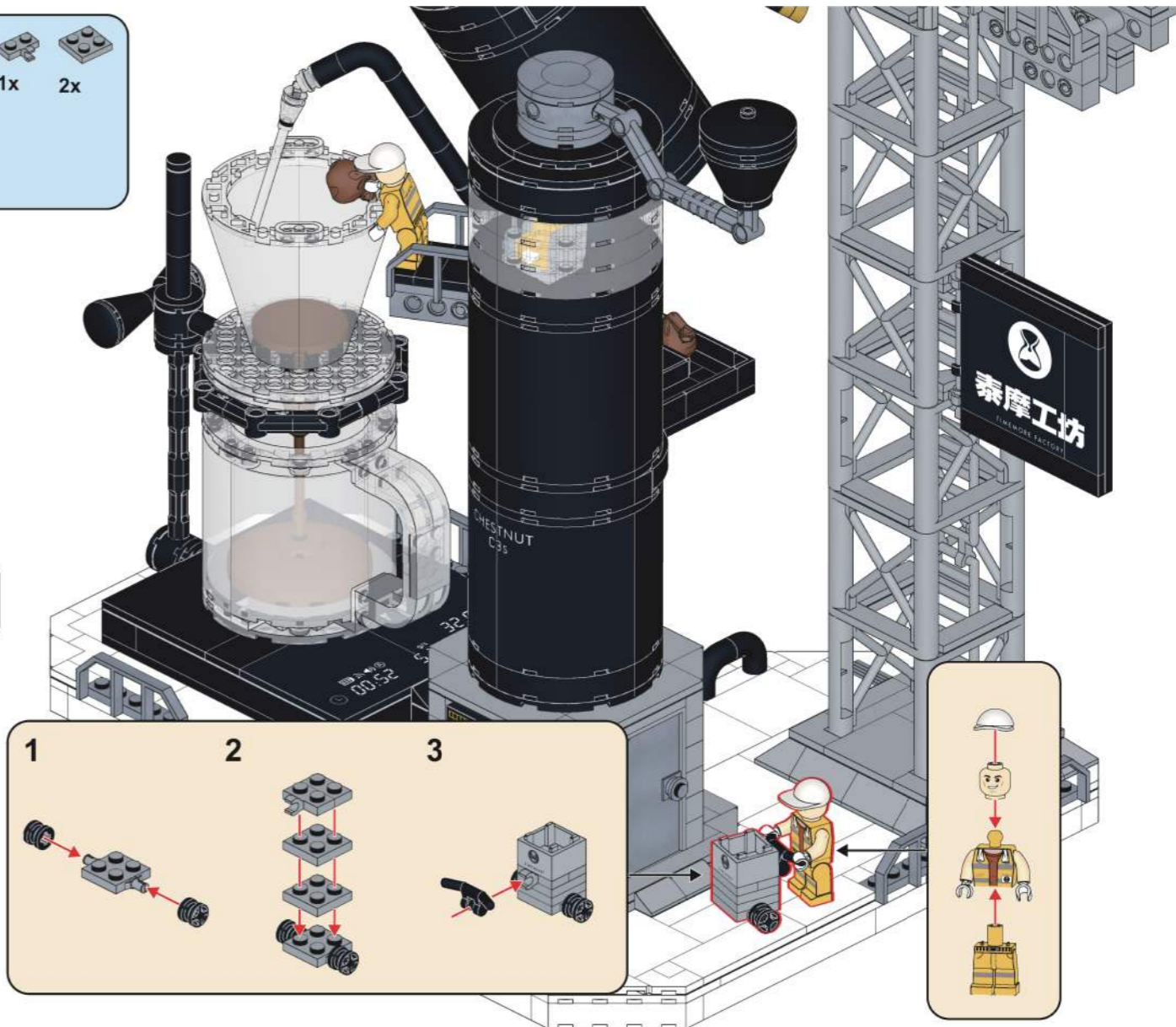

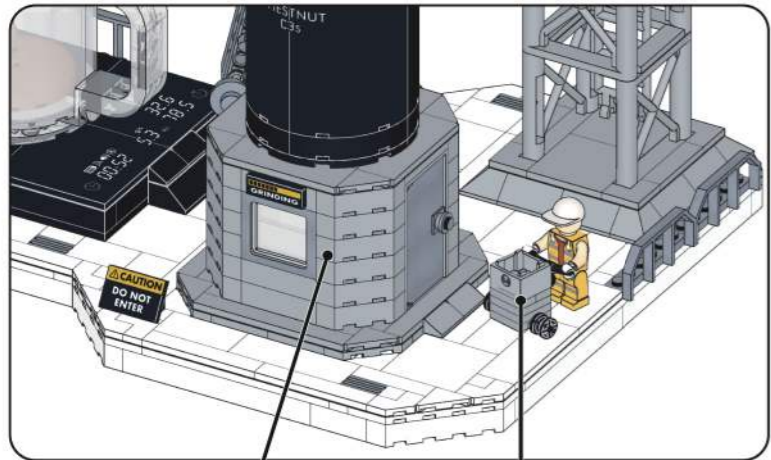

研磨室可放入三粒配置的咖啡豆。

推车可放两粒配置的咖啡豆。

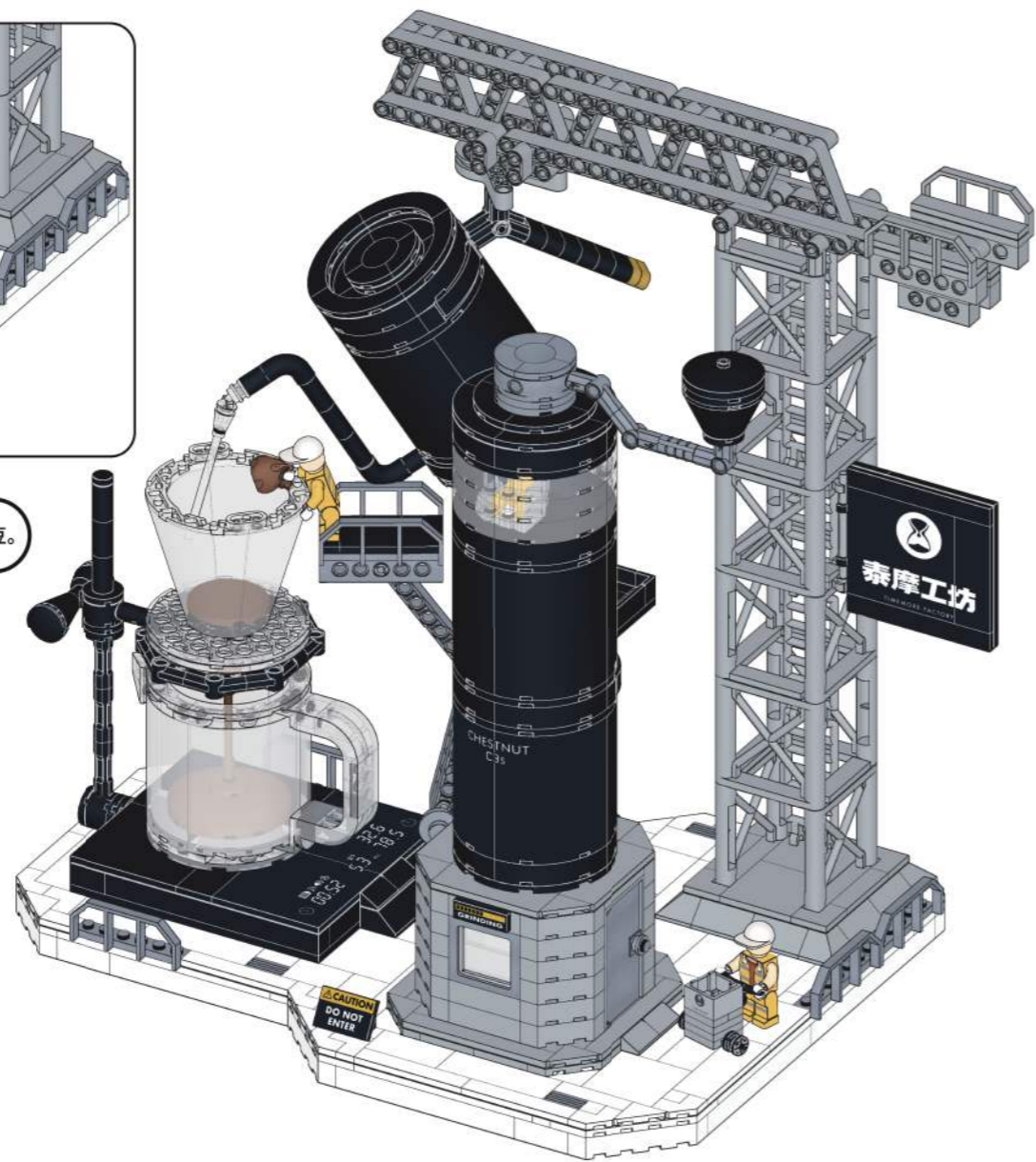



拼奇积木



TIME MORE®