



拼奇积木

15+
85003

Forest Cabin
森林木屋



为收藏而生

ADULTS WELCOME



1.按照分包袋序号依次拆包。
Unpack according to the package number.



2.按照零件颜色或者形状进行分类。
Classify pieces based on their color or shape.



3.按照说明书步骤中的零件表进行分拣。
Select in accordance with the piece list in the instruction book.

别着急,大多数的“缺件”情况都只是零件暂时走丢了,再仔细找找看吧。
Calm down. They're accidentally lost in the corner in most cases. So take another look and find them!



也可以扫码关注拼奇官方公众号,点击【官方补件】进行申请,即可享受官方极速补件服务。

每个套装都会预留少量备用零件,拼搭完成后有少量零件剩余无须担心,可以储存起来日后使用哦。
We provide extra pieces for every set. So don't worry about it! You can put them away for future use.



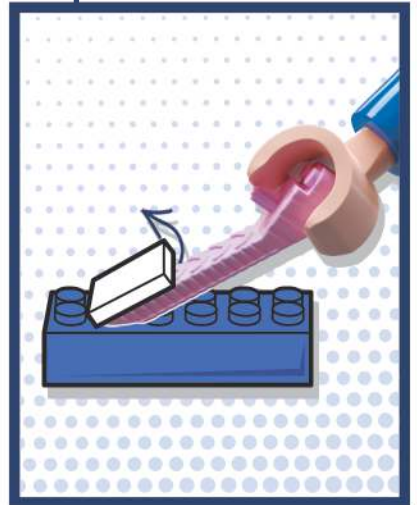
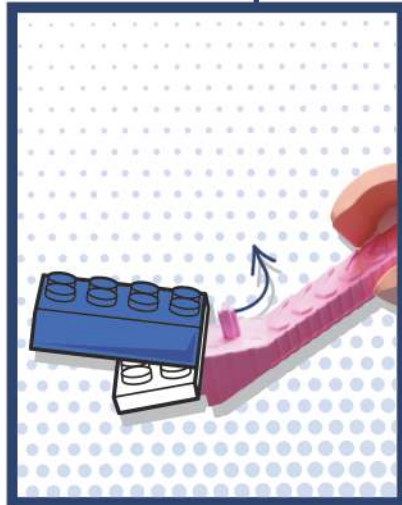
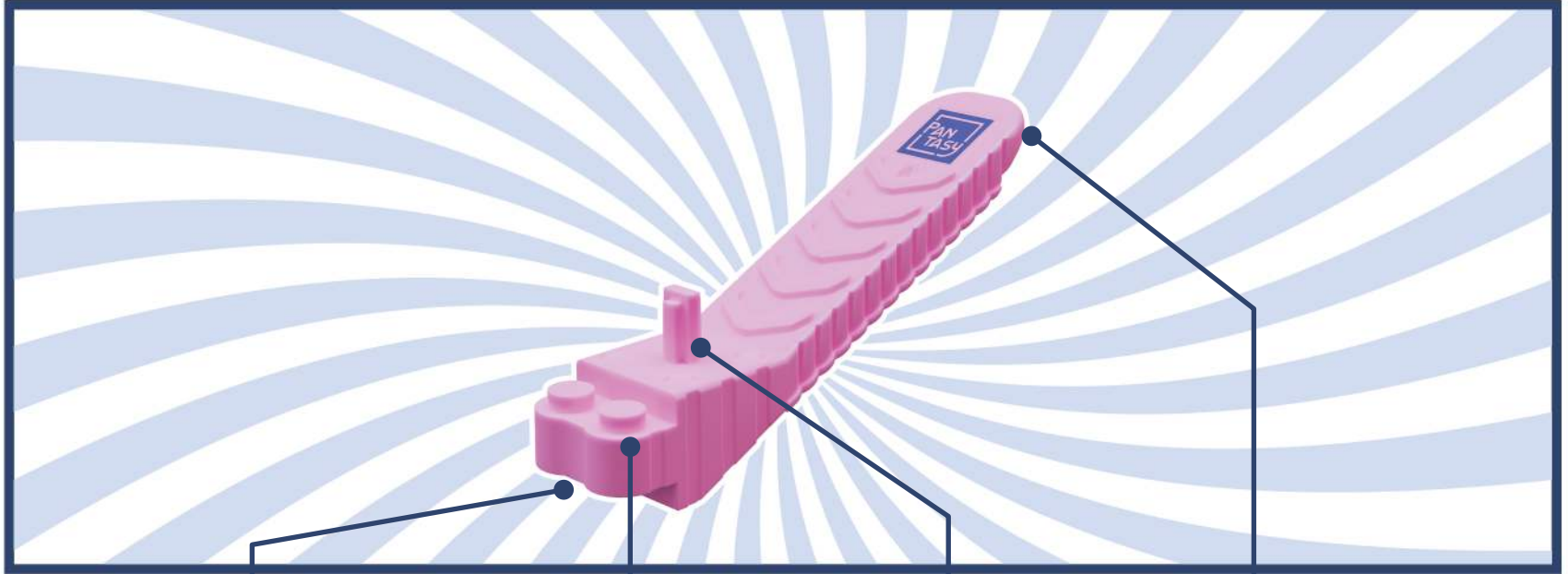

Pantasy Customer Support

Missing parts or pieces problem?

Contact us via

 global@pantasy.com

Pantasy Official Website

You can learn more about us.

Shop@  www.pantasy.com



Follow us

 Instagram

 Facebook



Official account:
Pantasy

Facebook group:
Pantasy Bricks

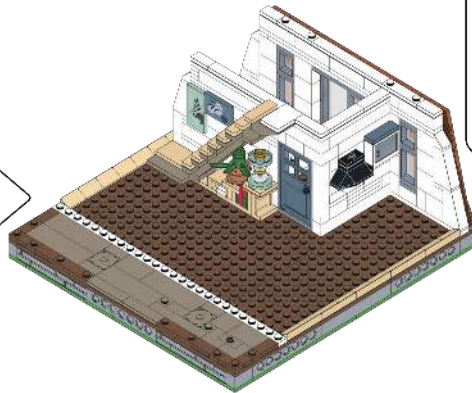
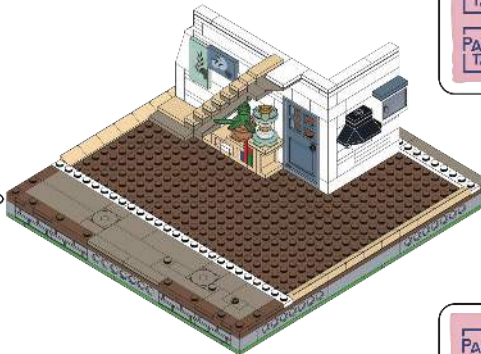
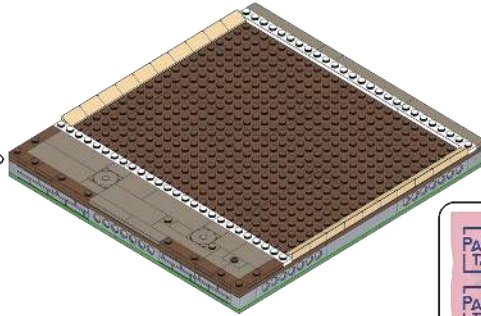

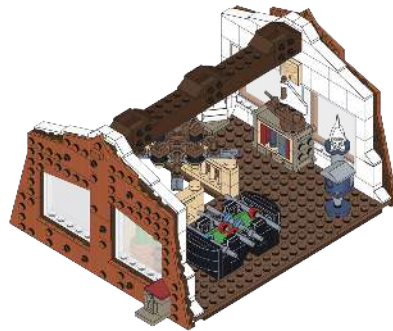



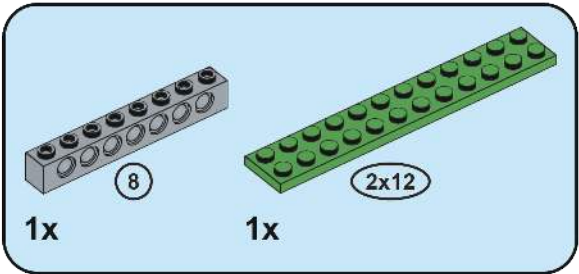
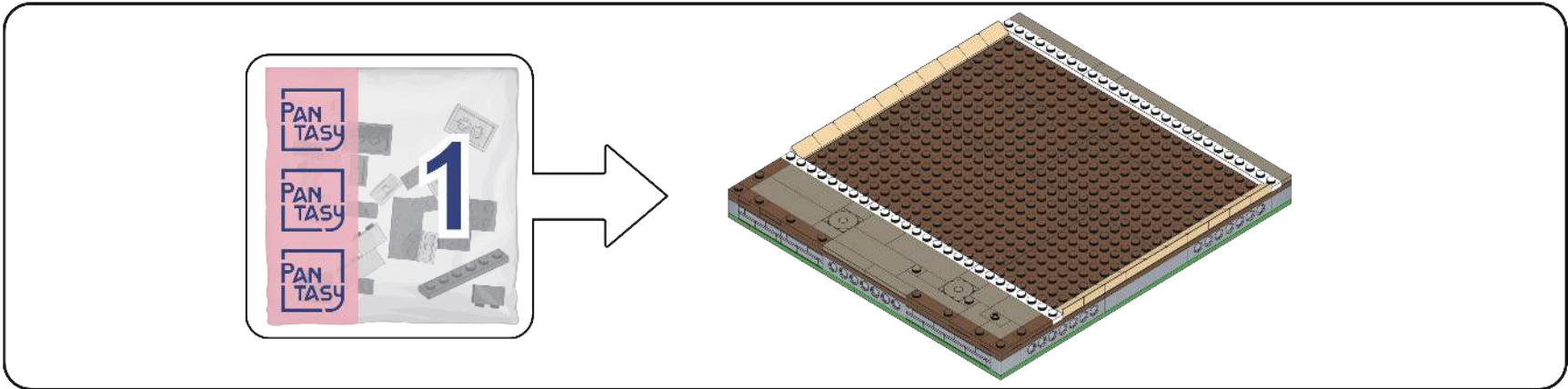

1

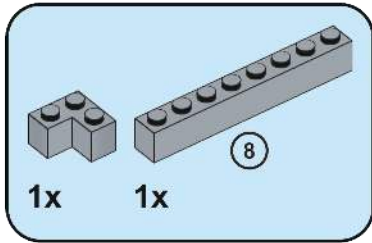
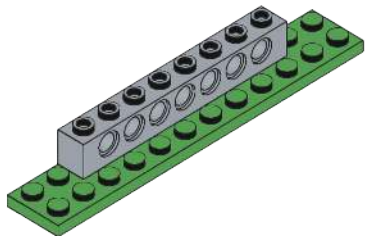

2

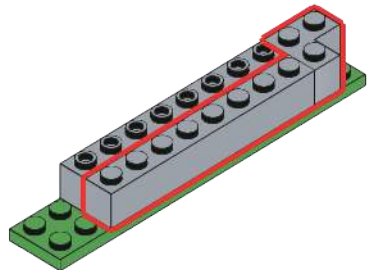

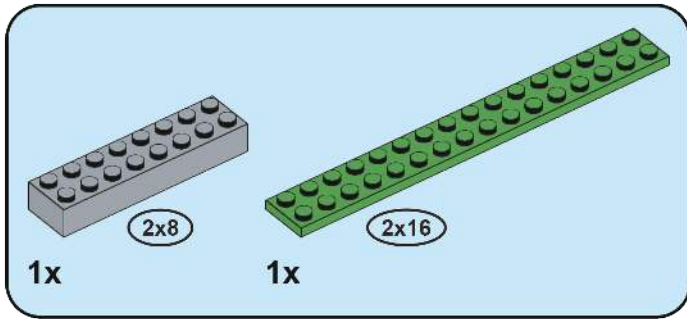

3

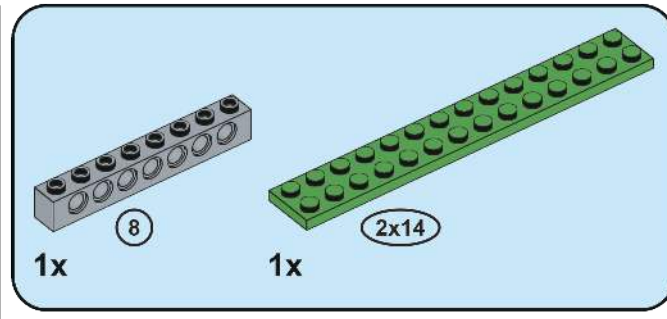
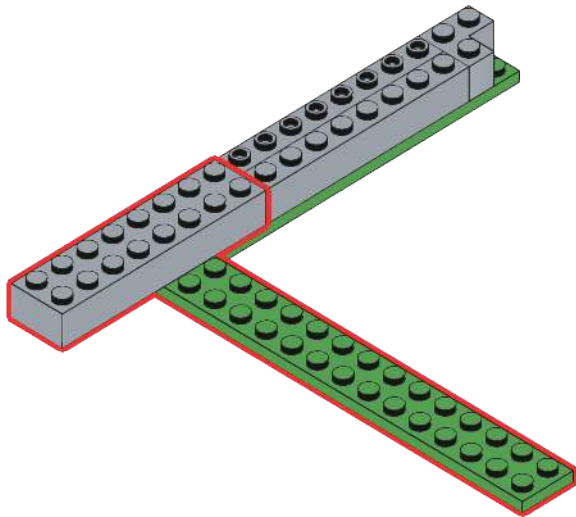

4

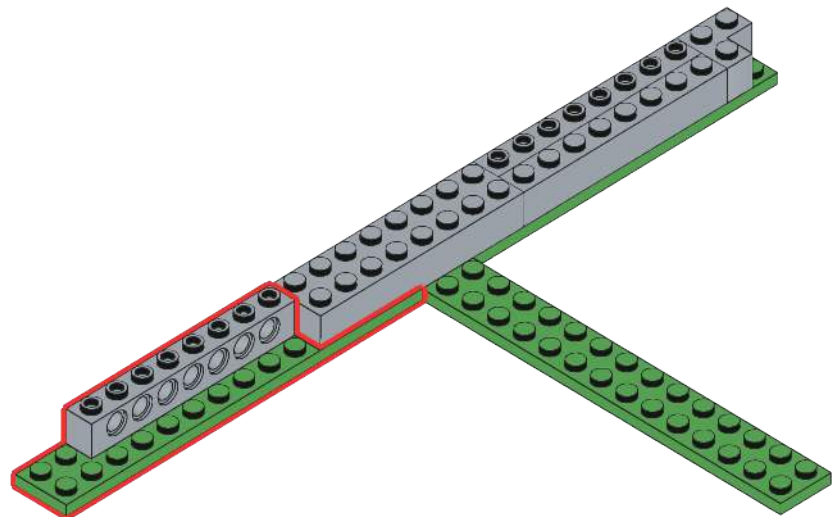

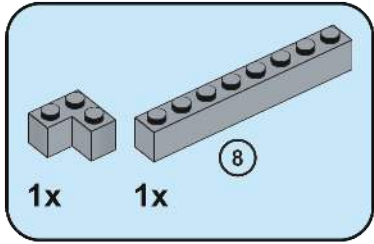

5

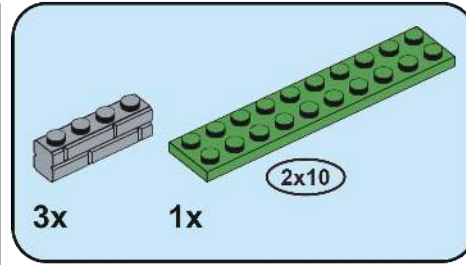
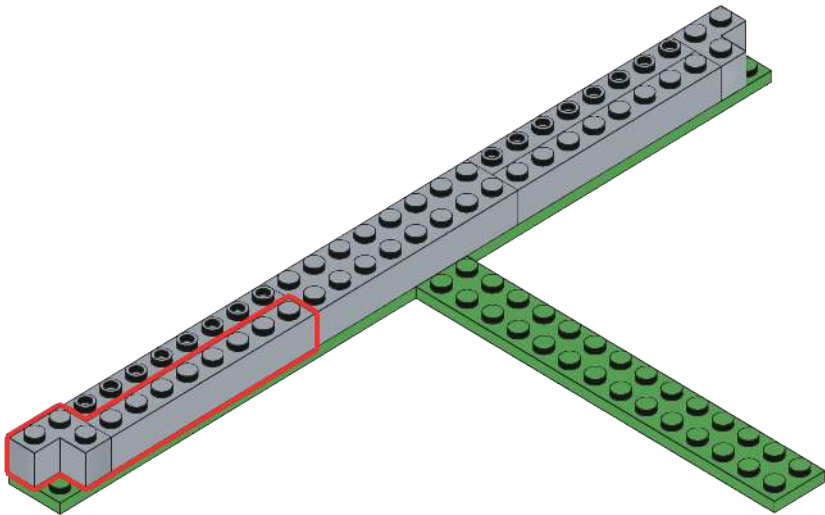

6

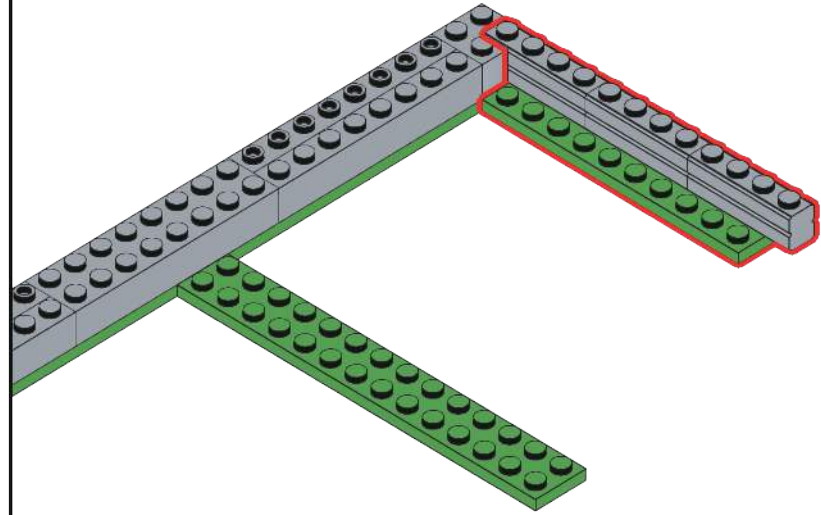

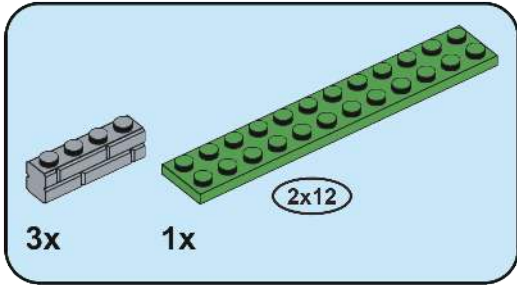

7

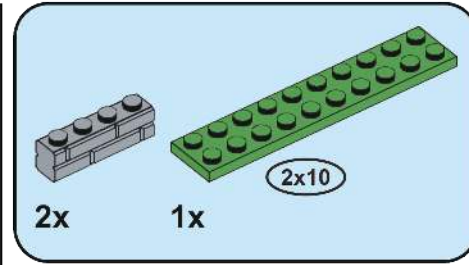
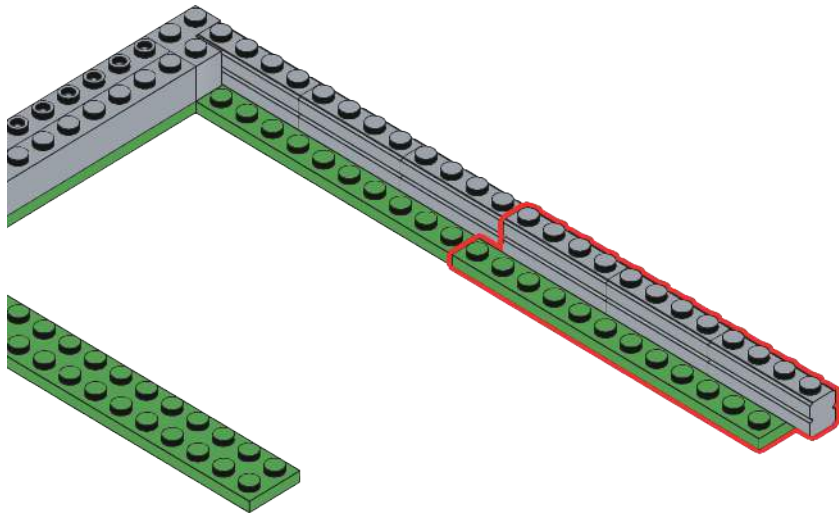

8

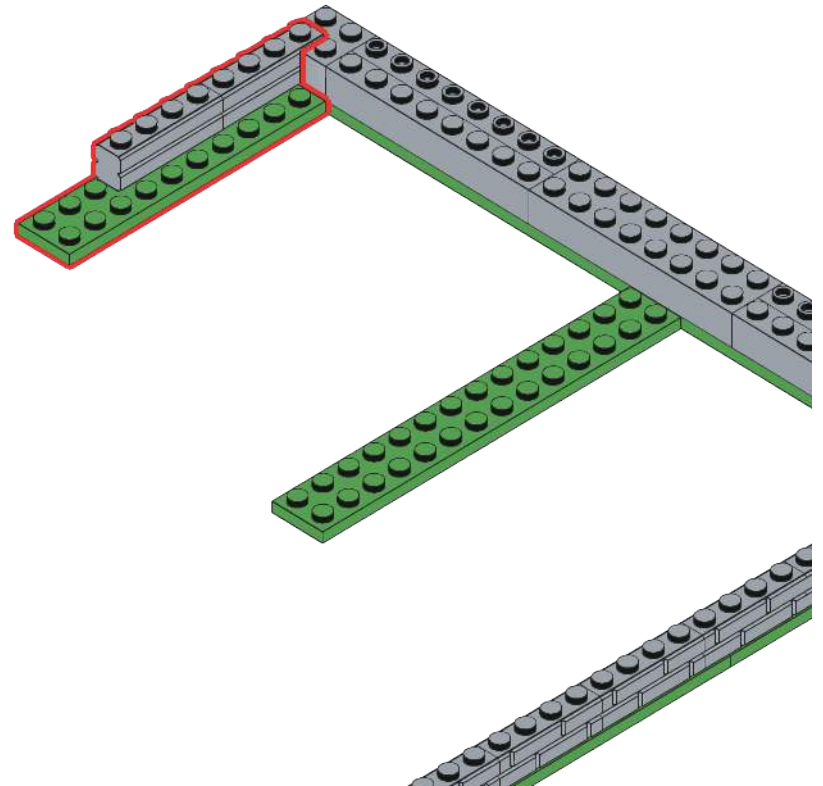

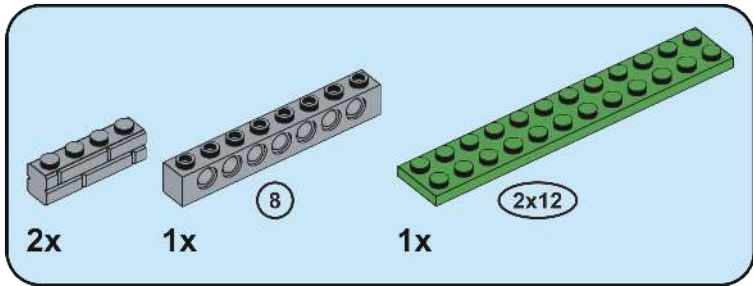

9

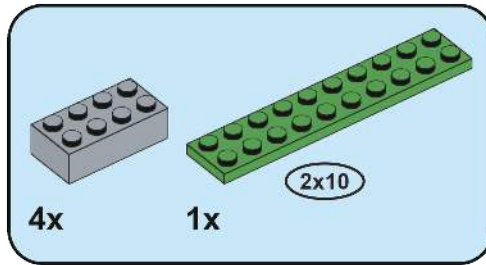
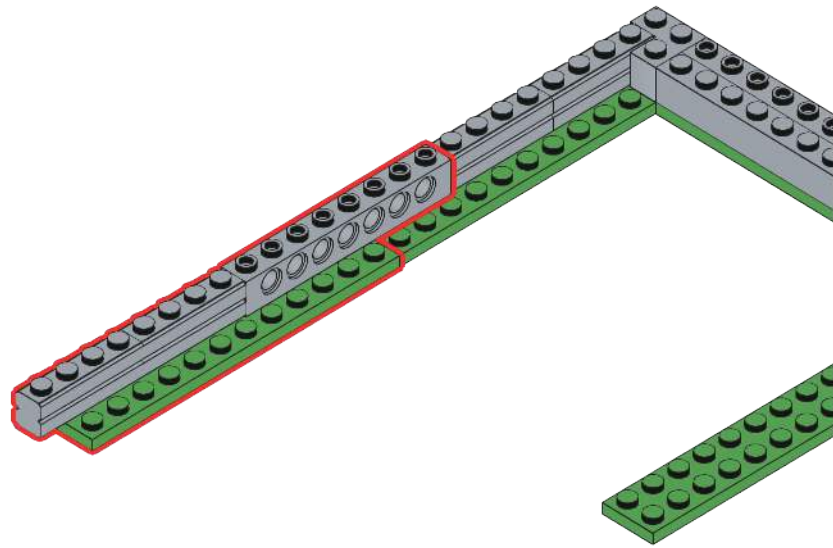

10

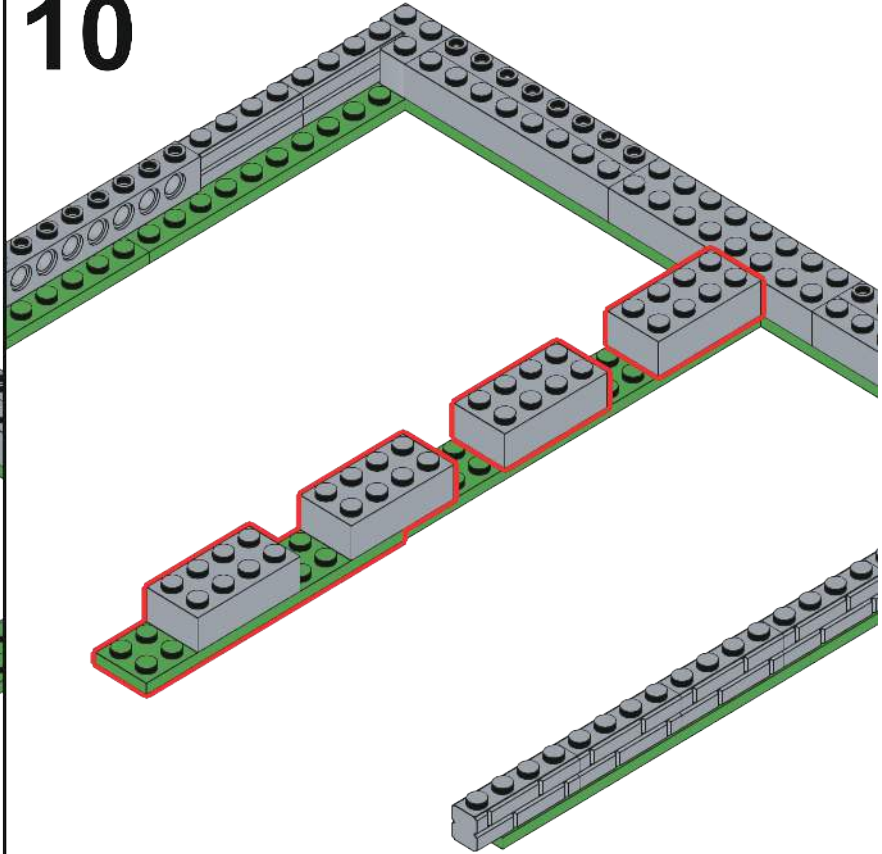

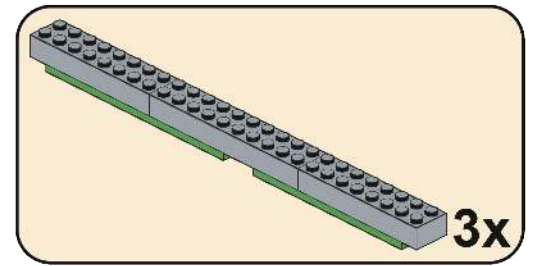
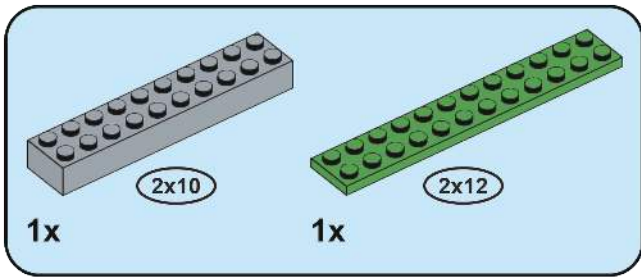

11

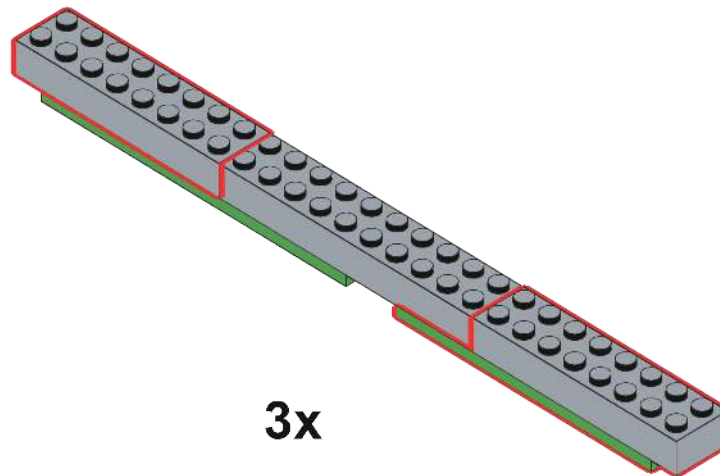
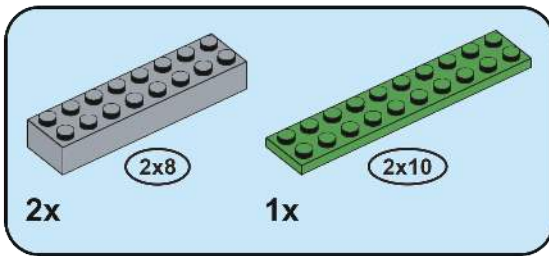
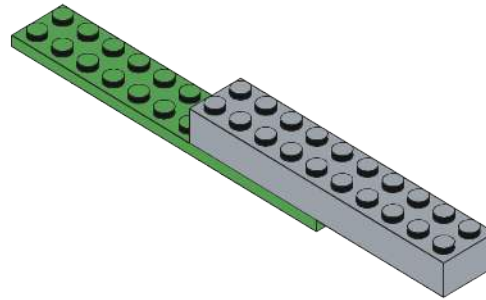

12

13

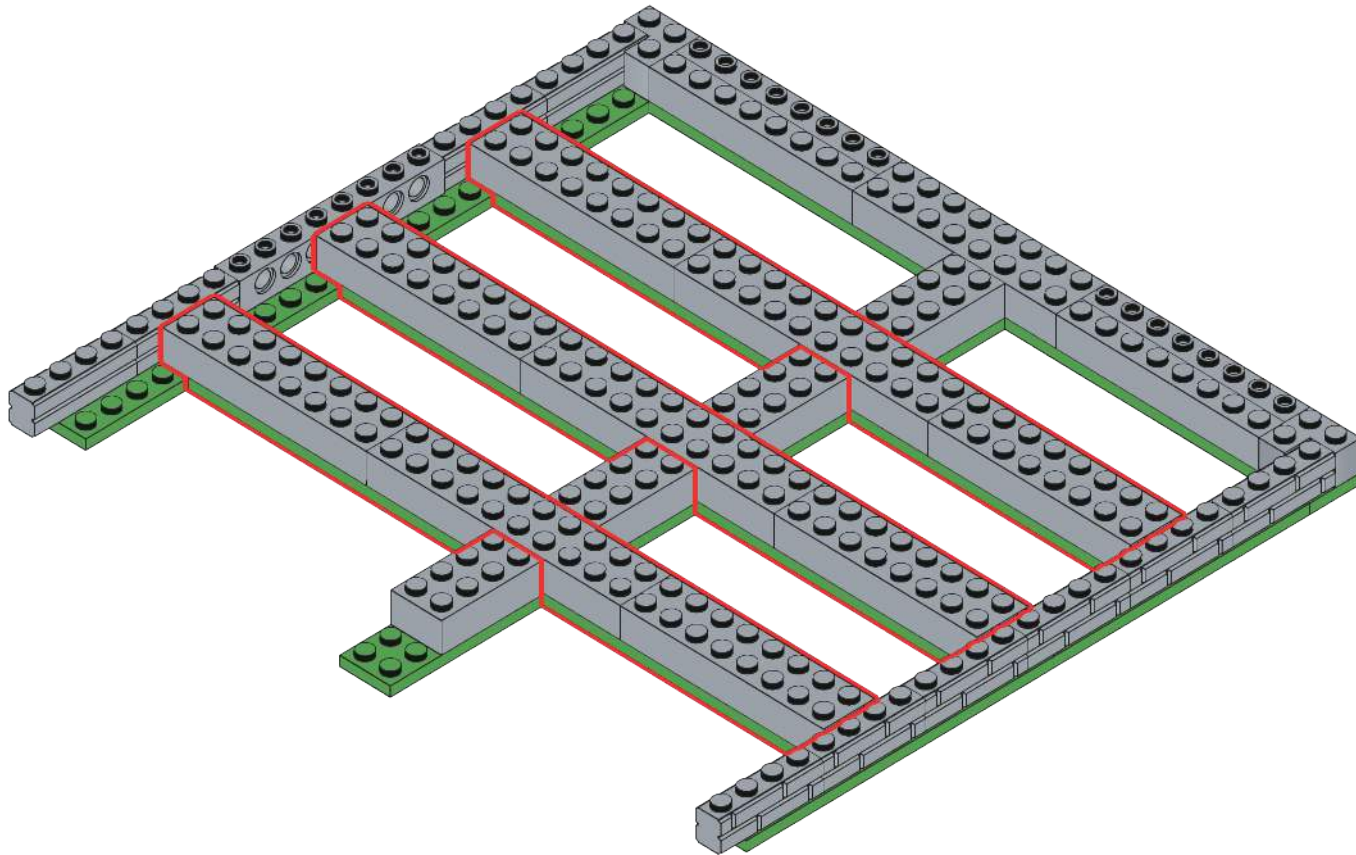

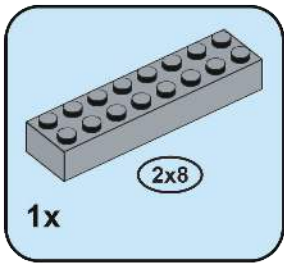

14

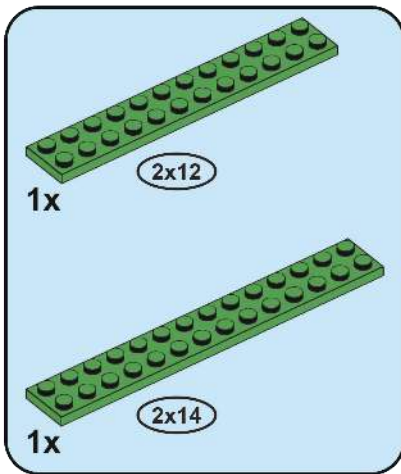
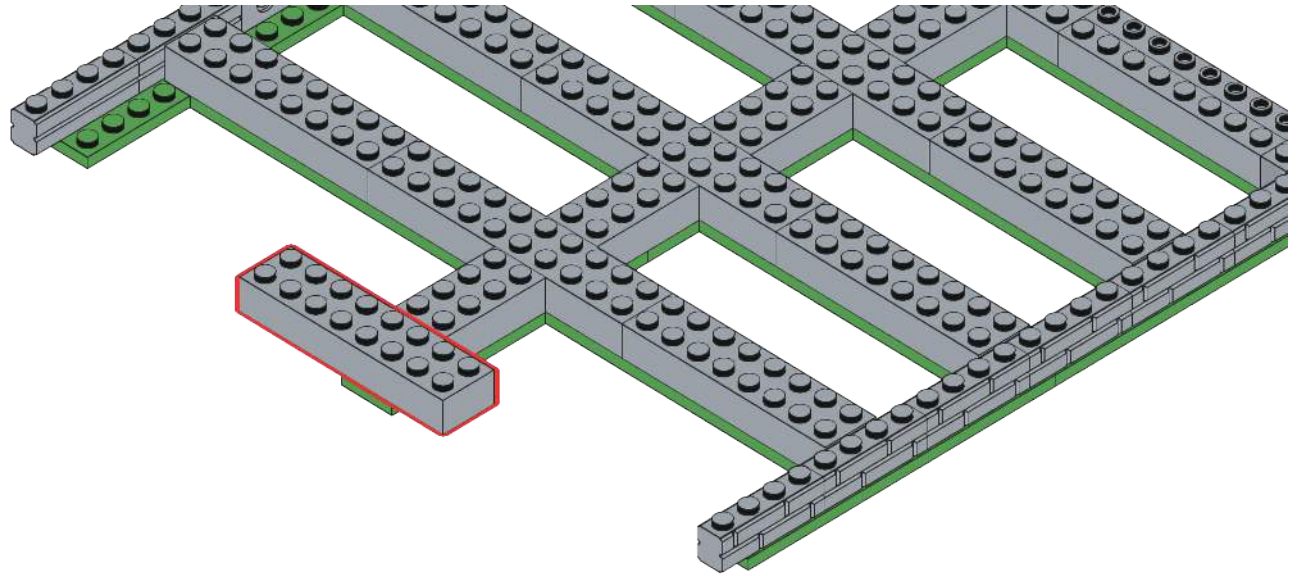

15

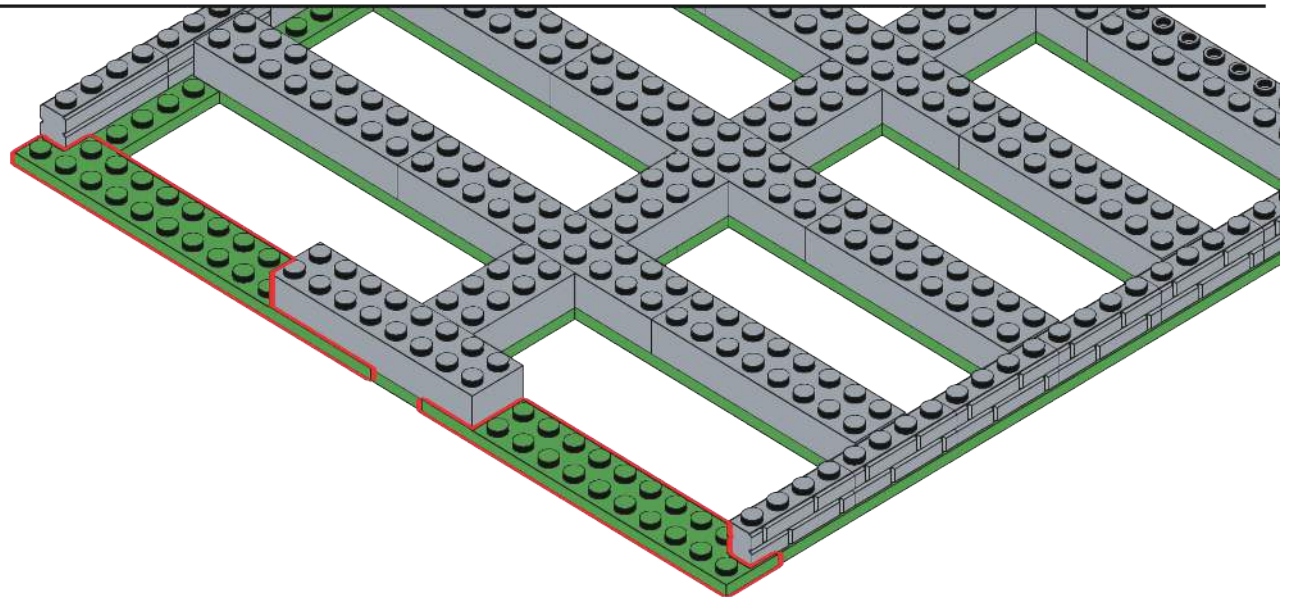

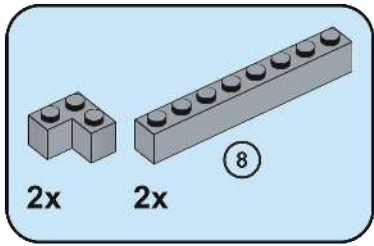

16

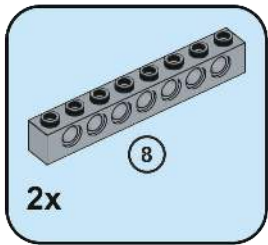
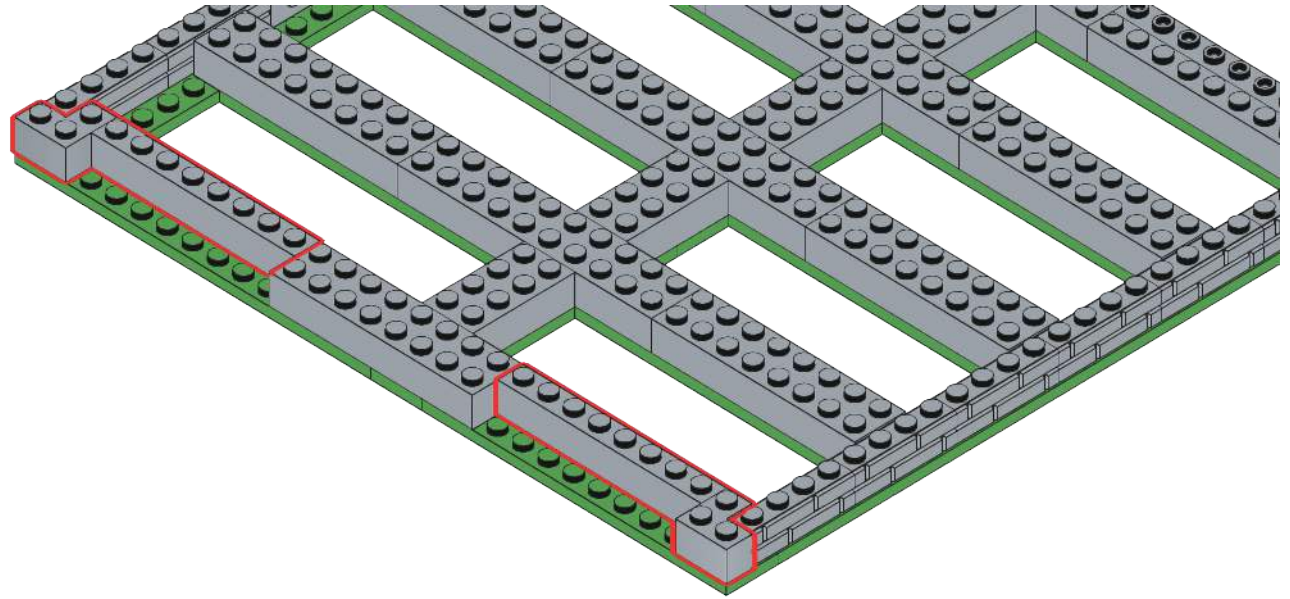

17

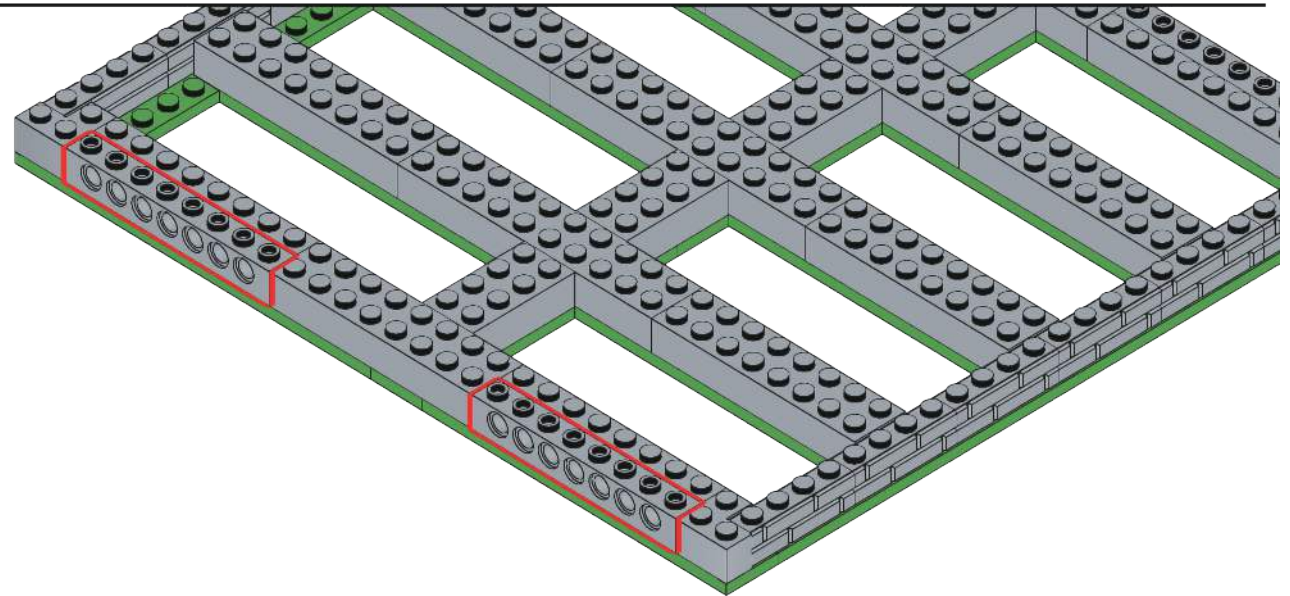

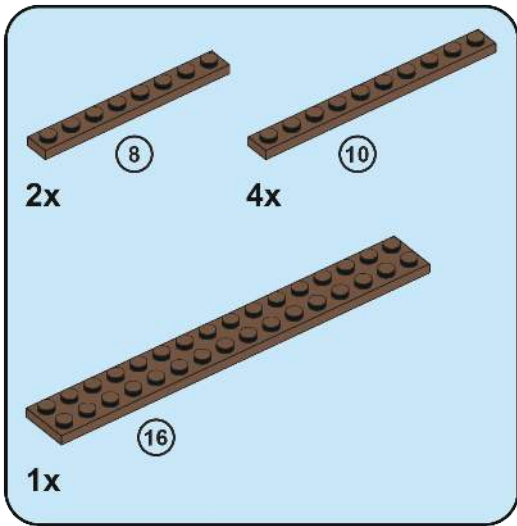

18

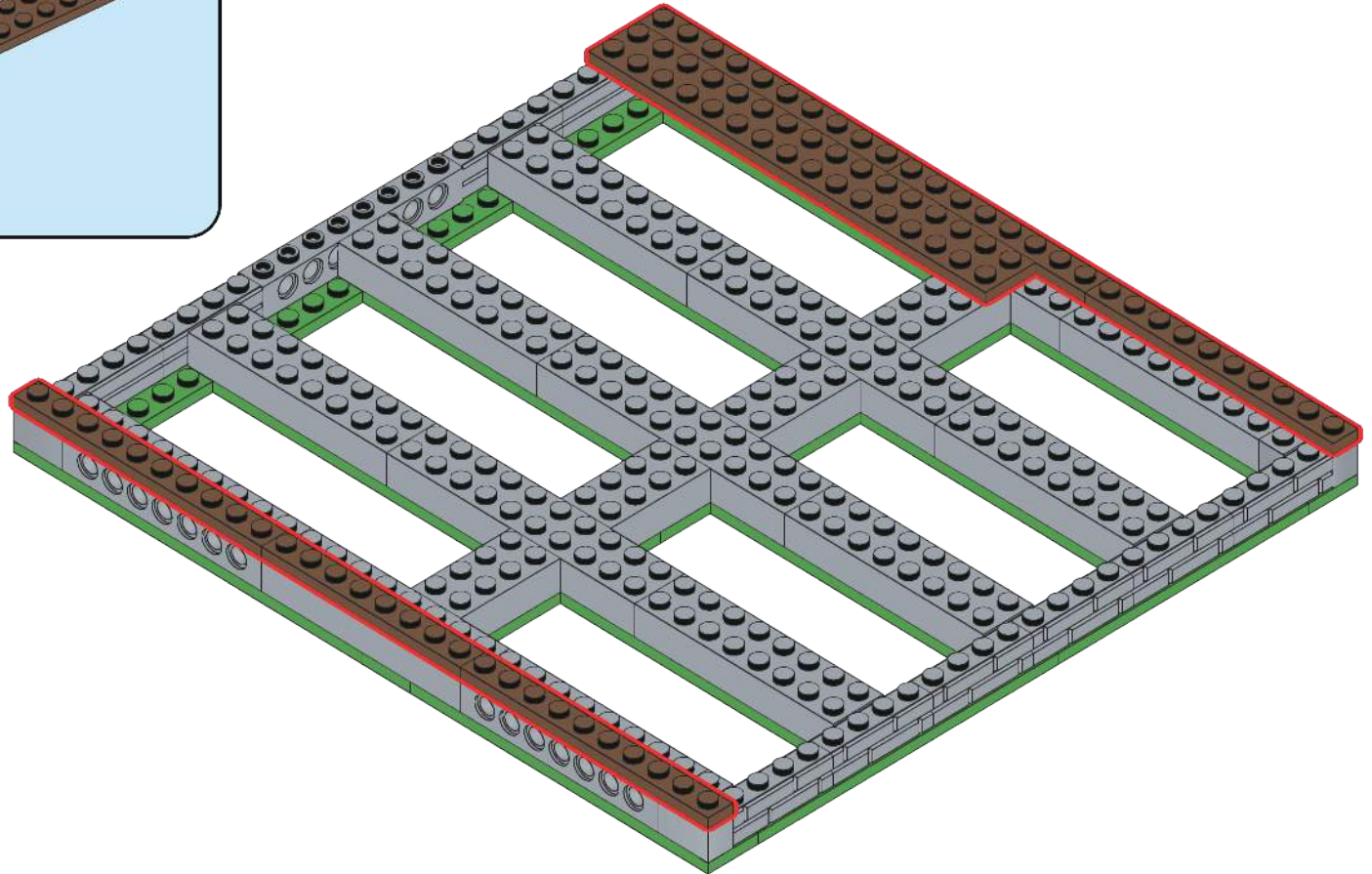

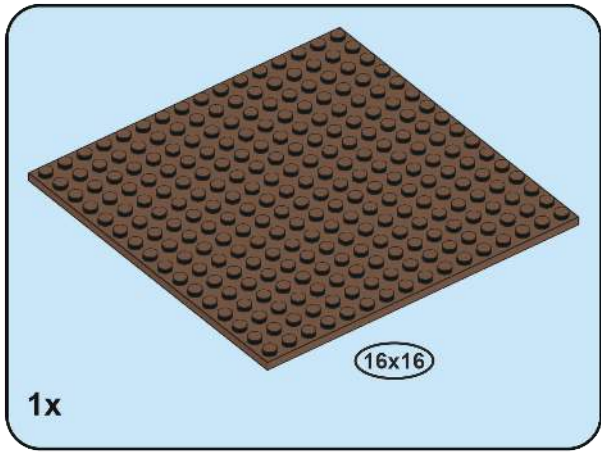

19

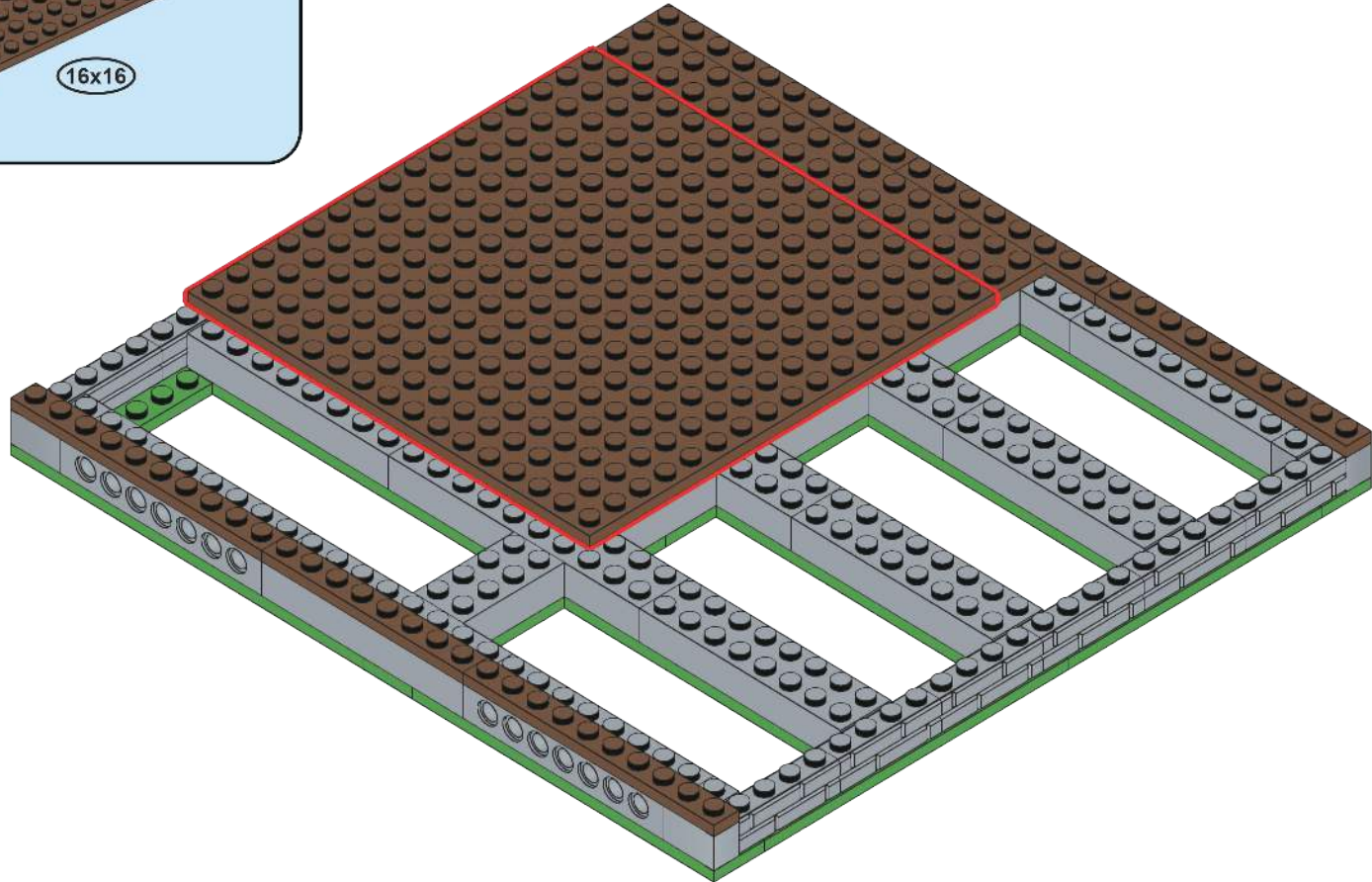

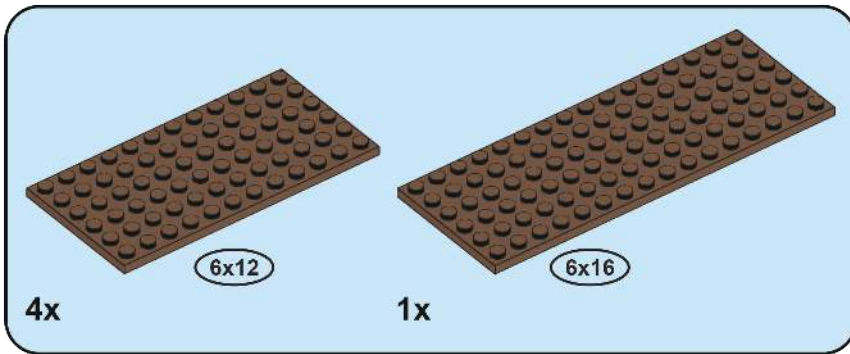

20

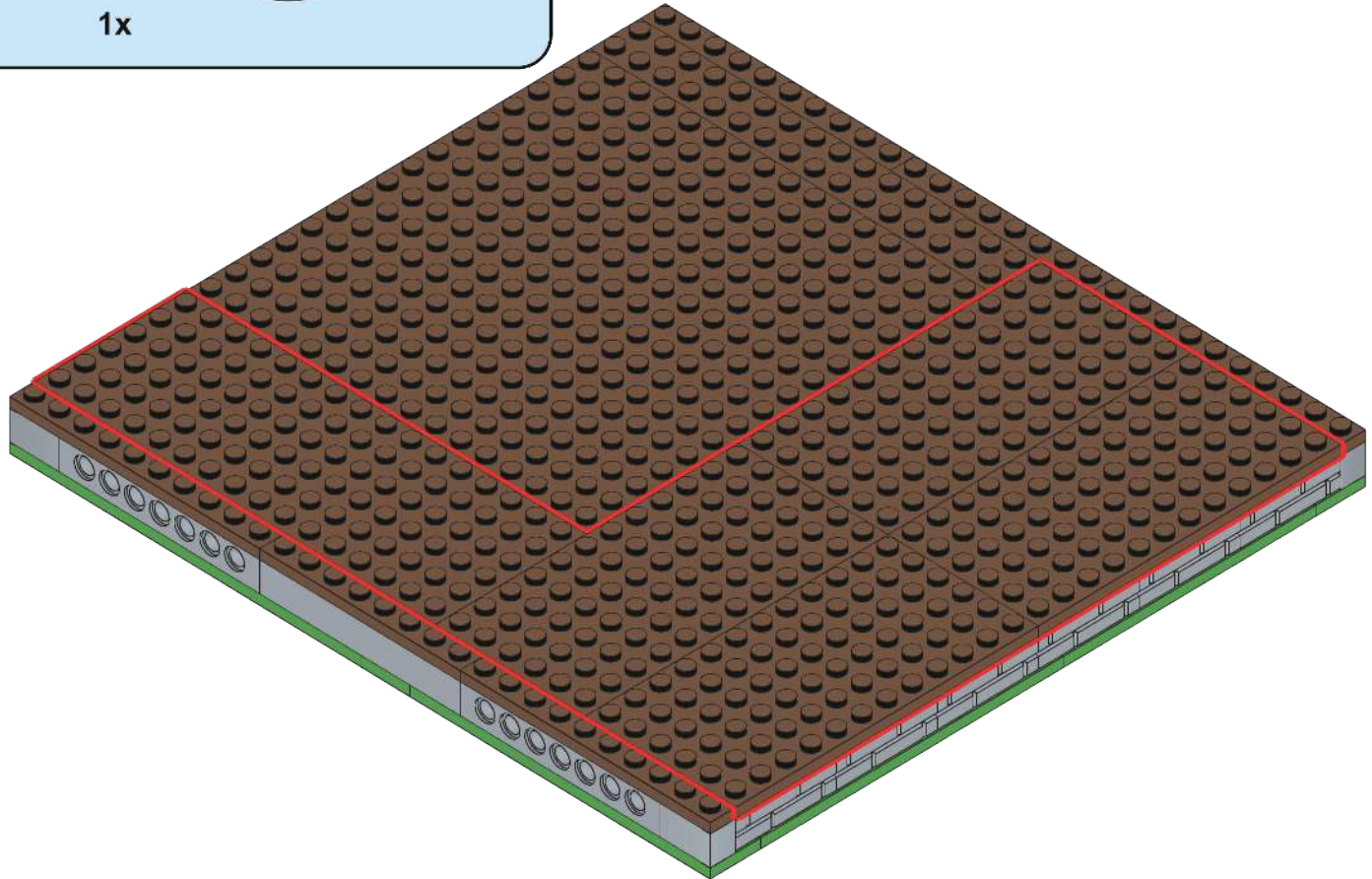

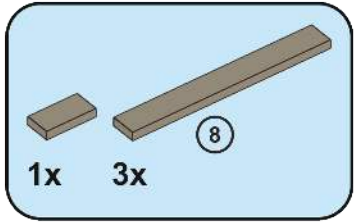

21

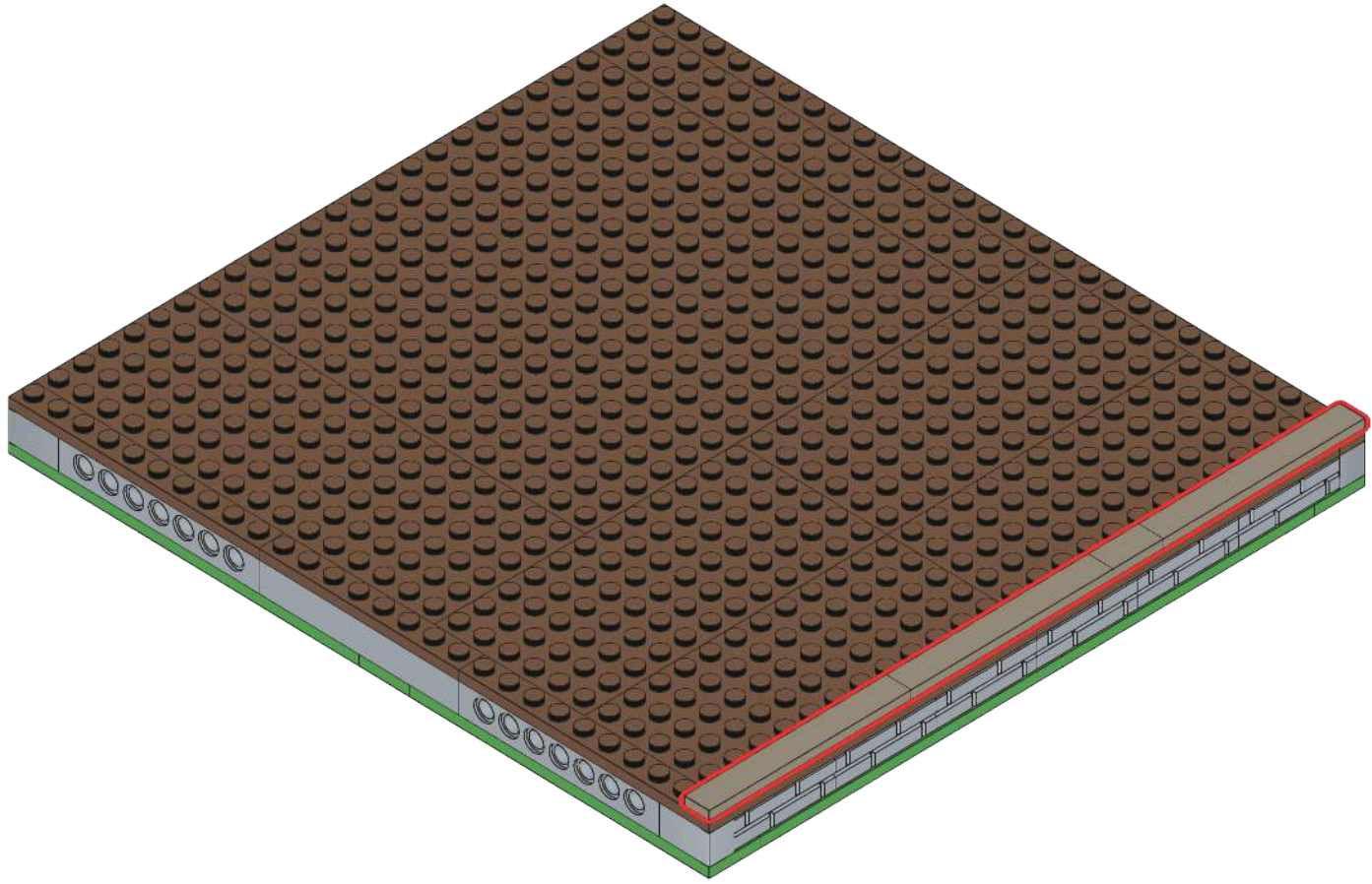

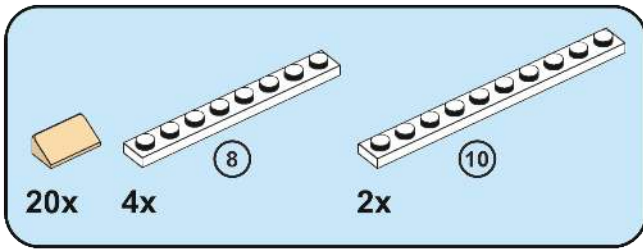

22

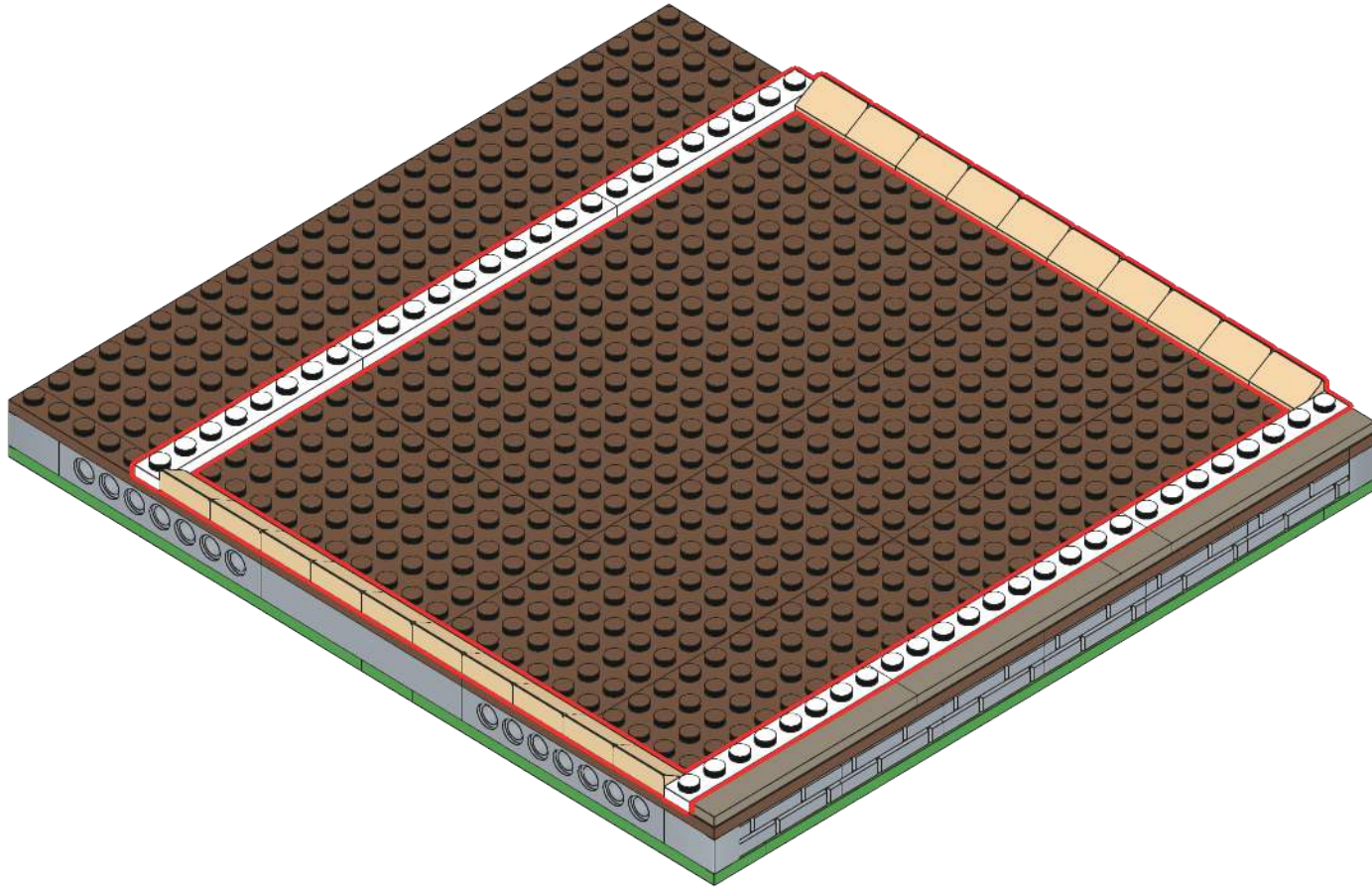

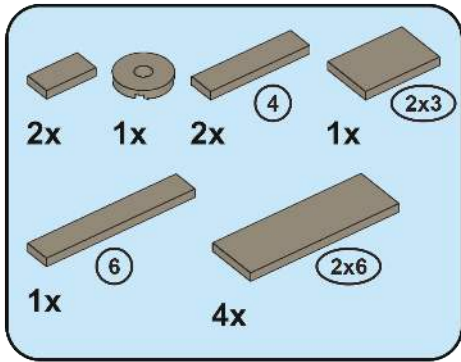

23

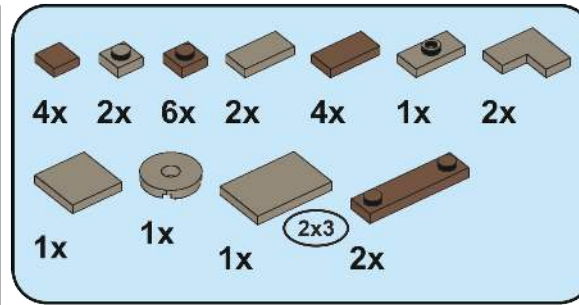
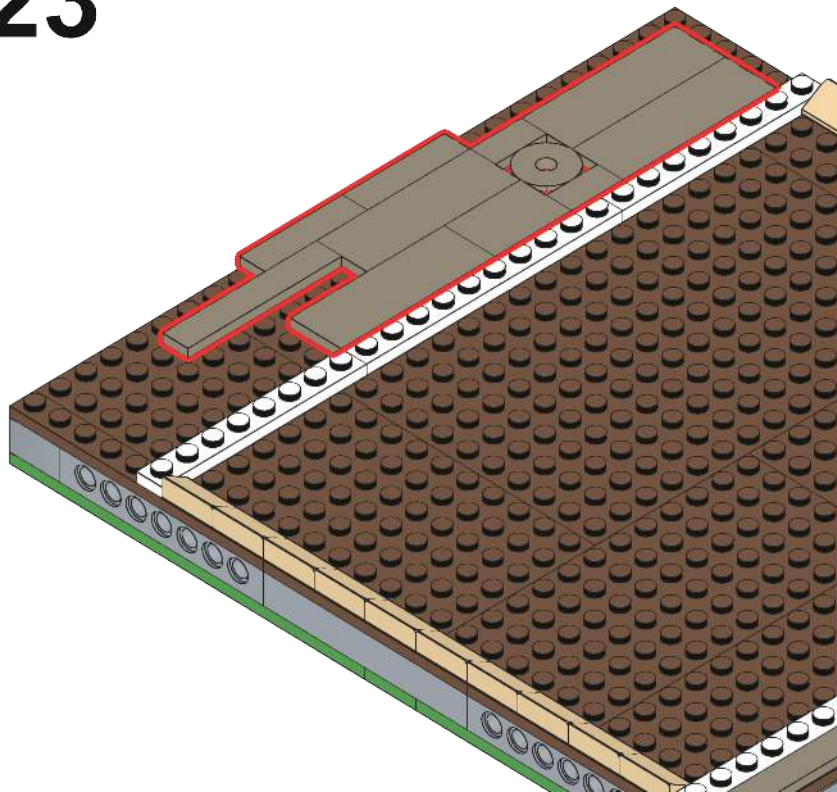

24

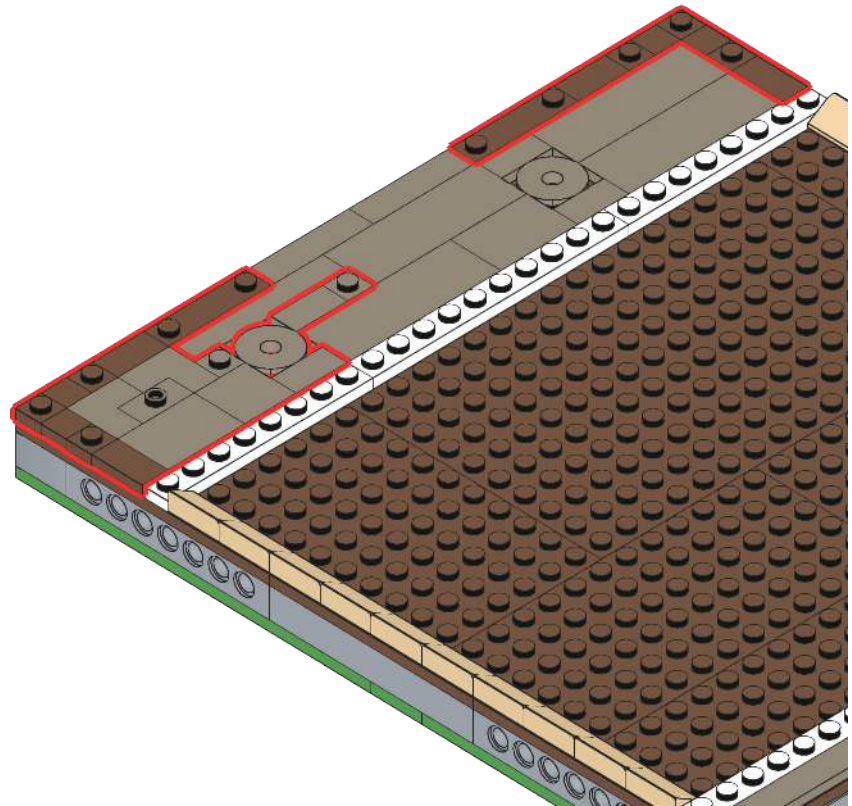

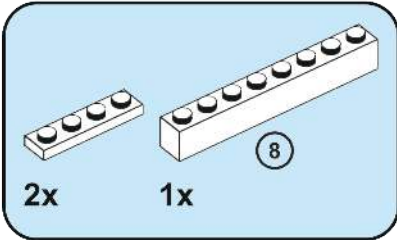
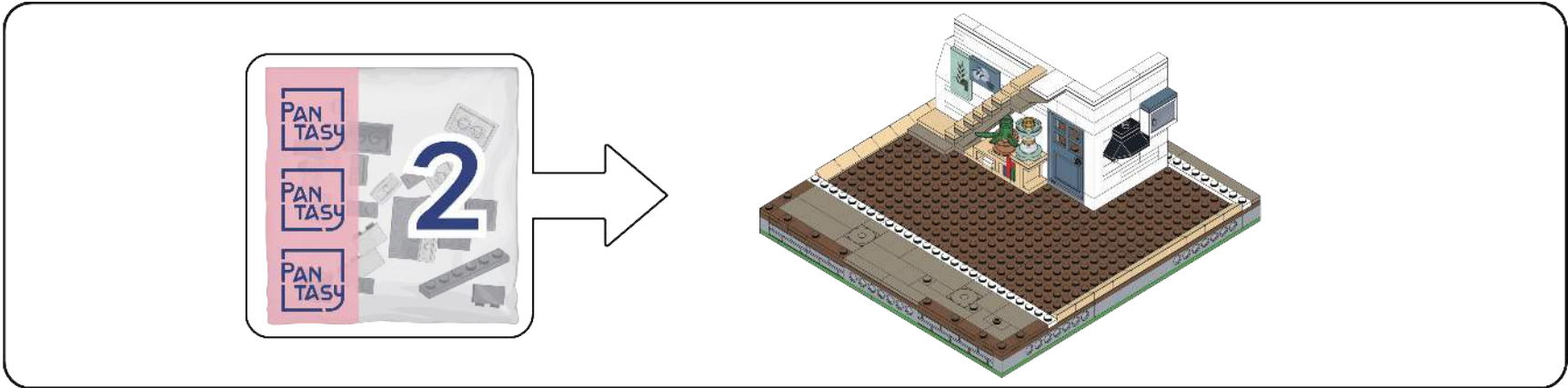

25

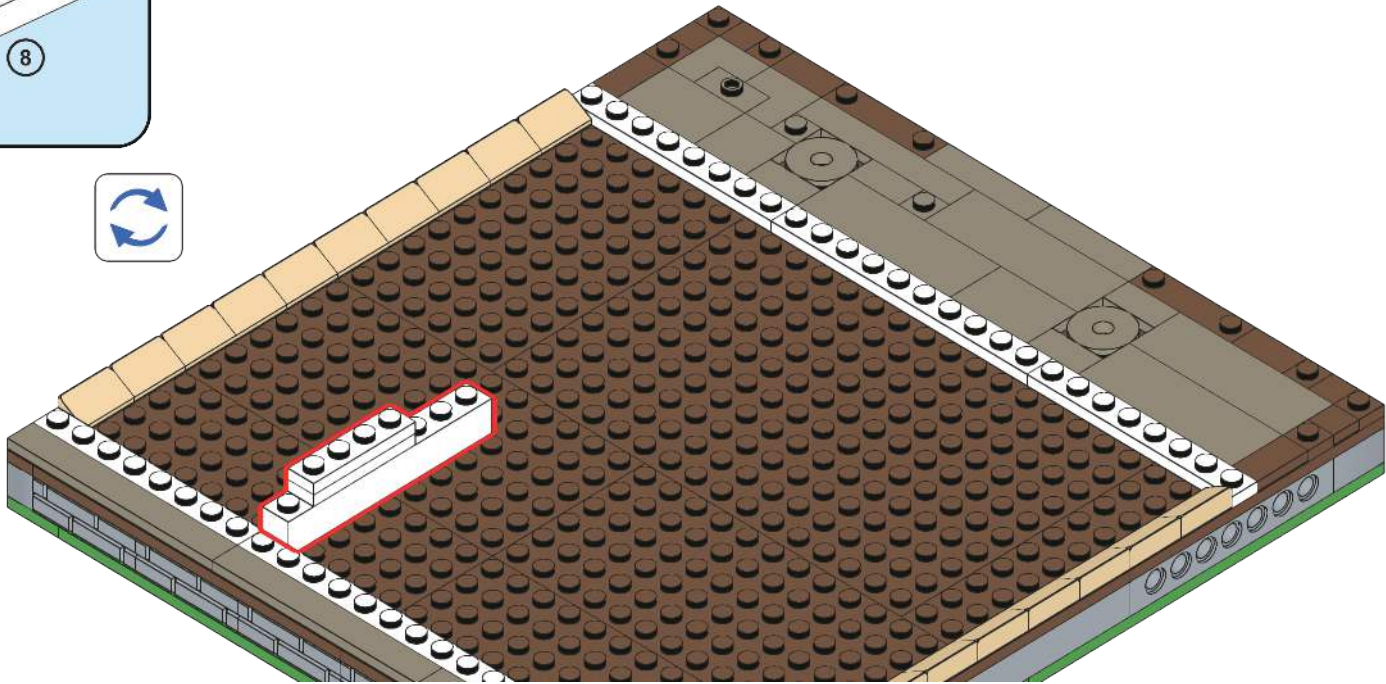

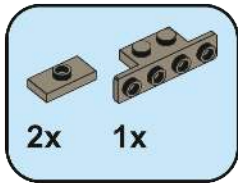

26

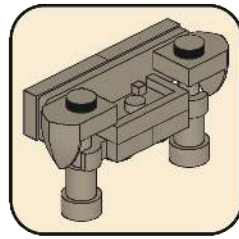
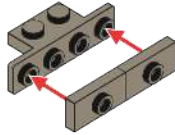

29



27

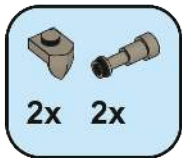
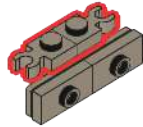

28

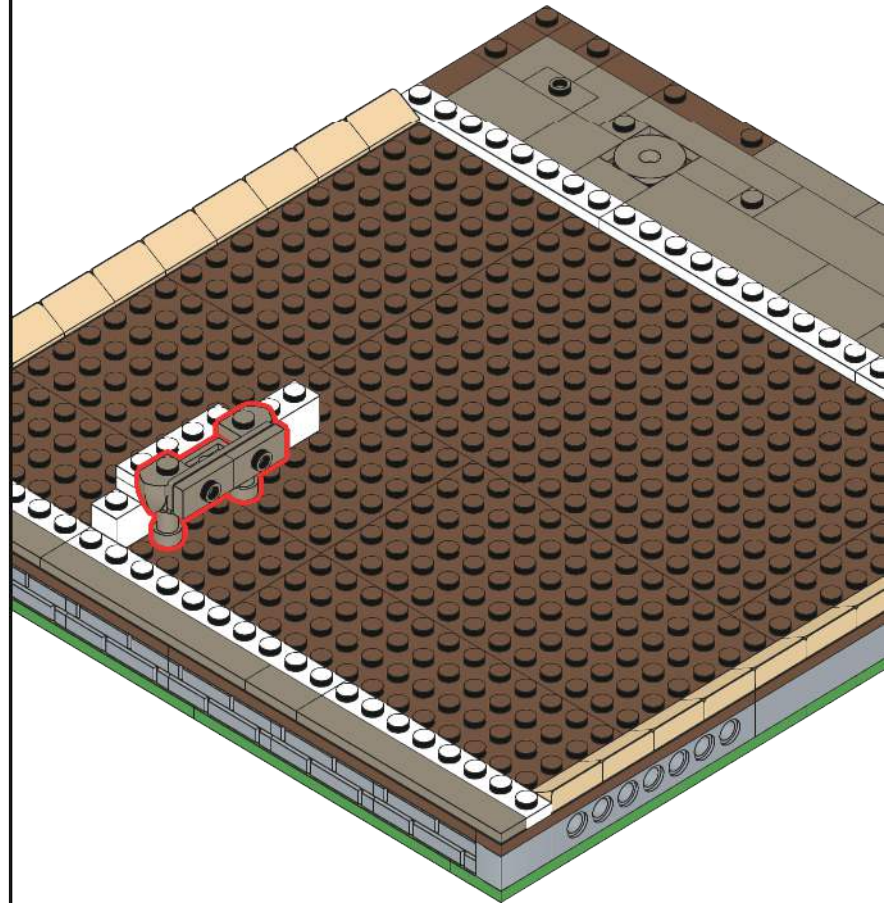
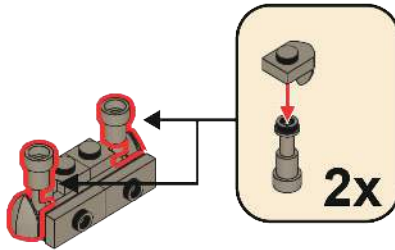

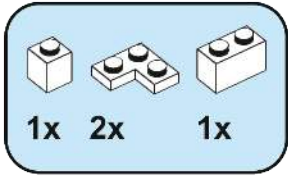

30

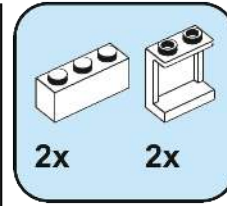
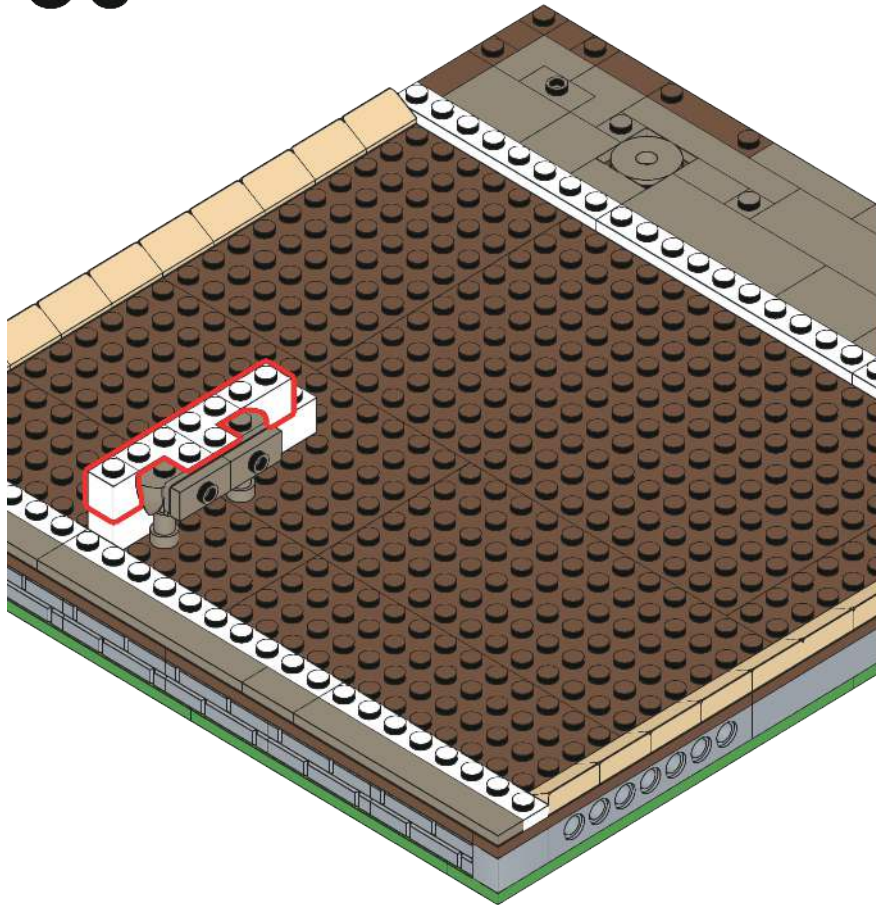

31

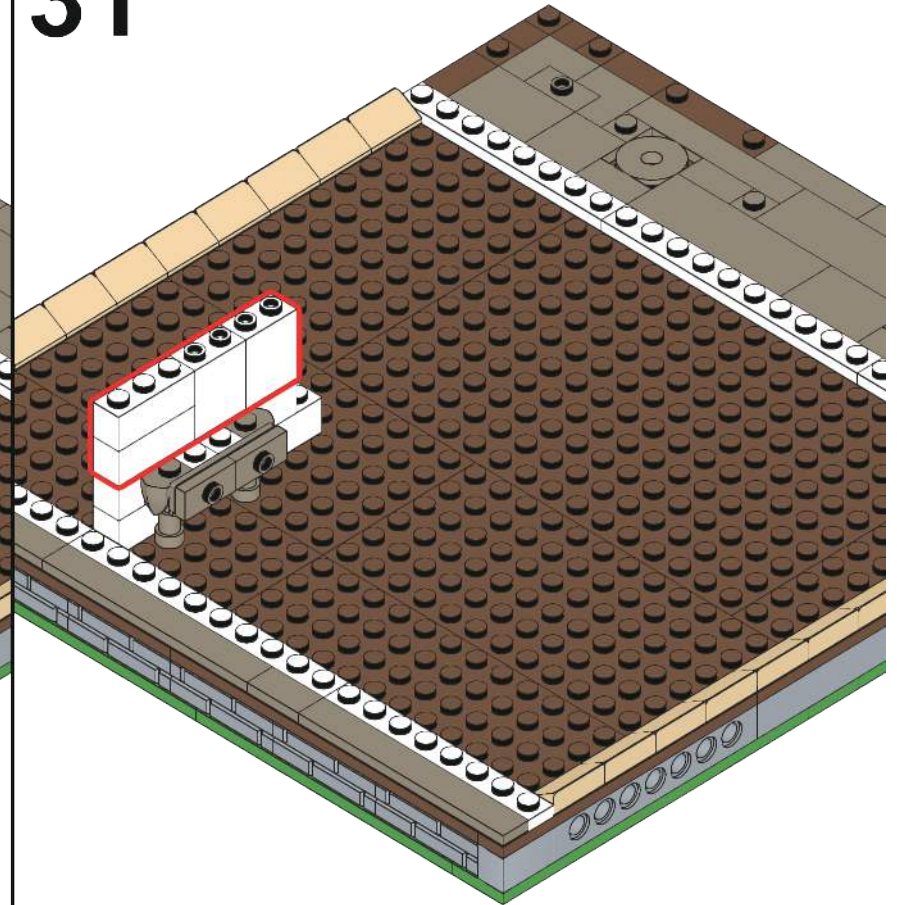

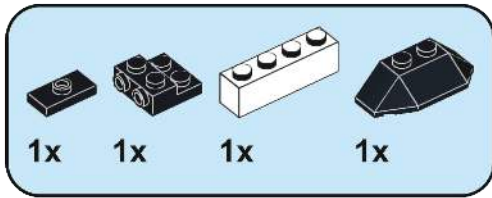

32

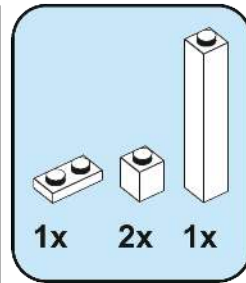
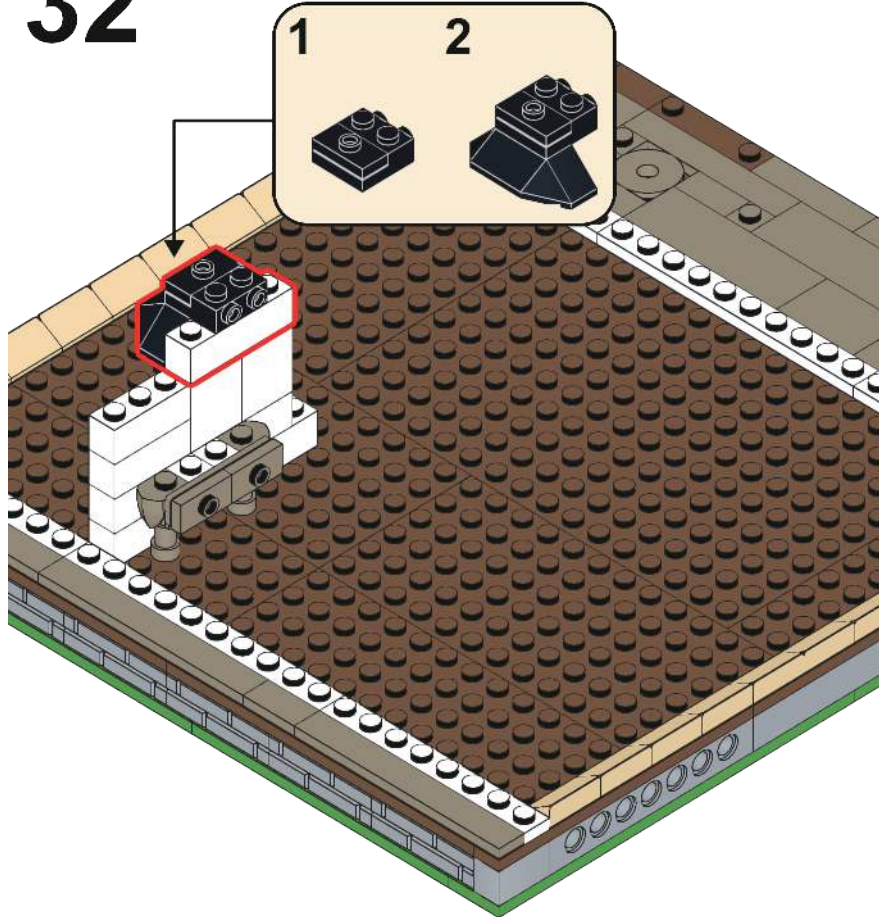
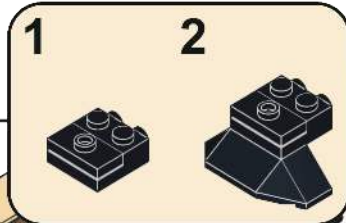

33

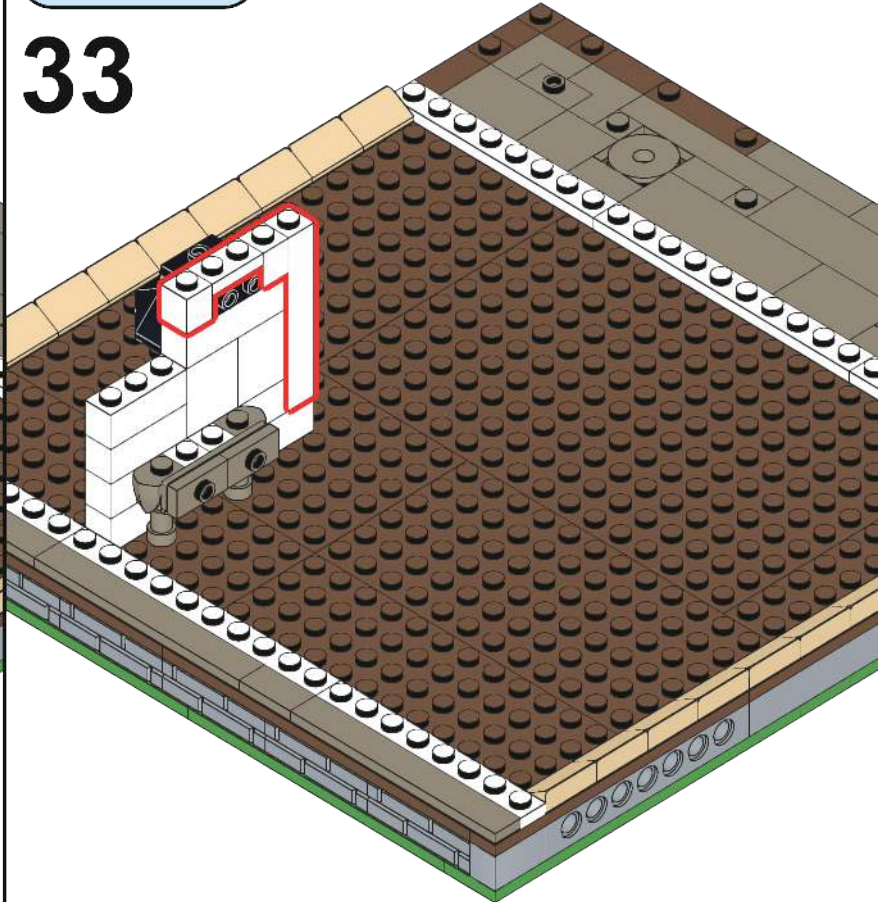

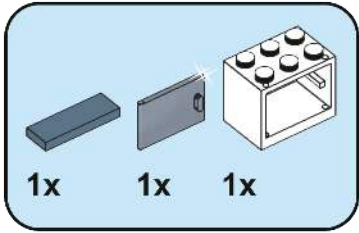

34

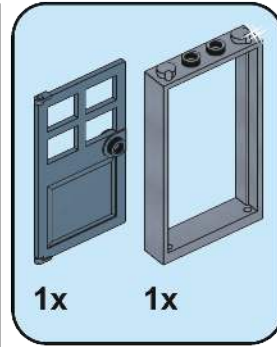
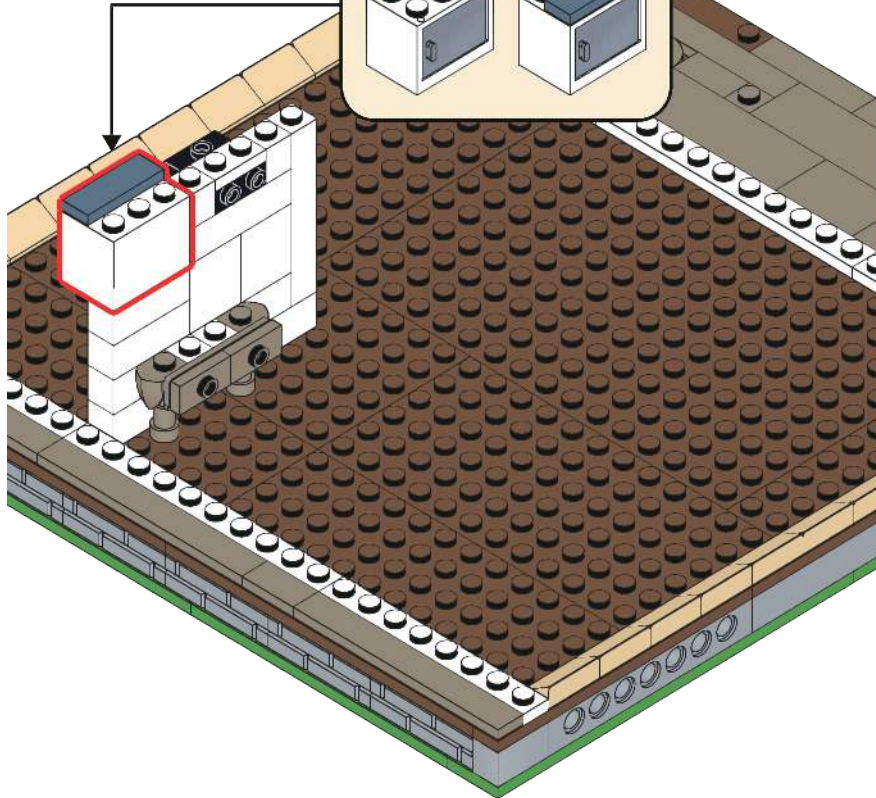
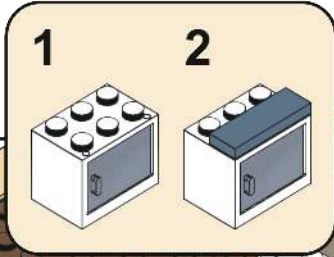

35

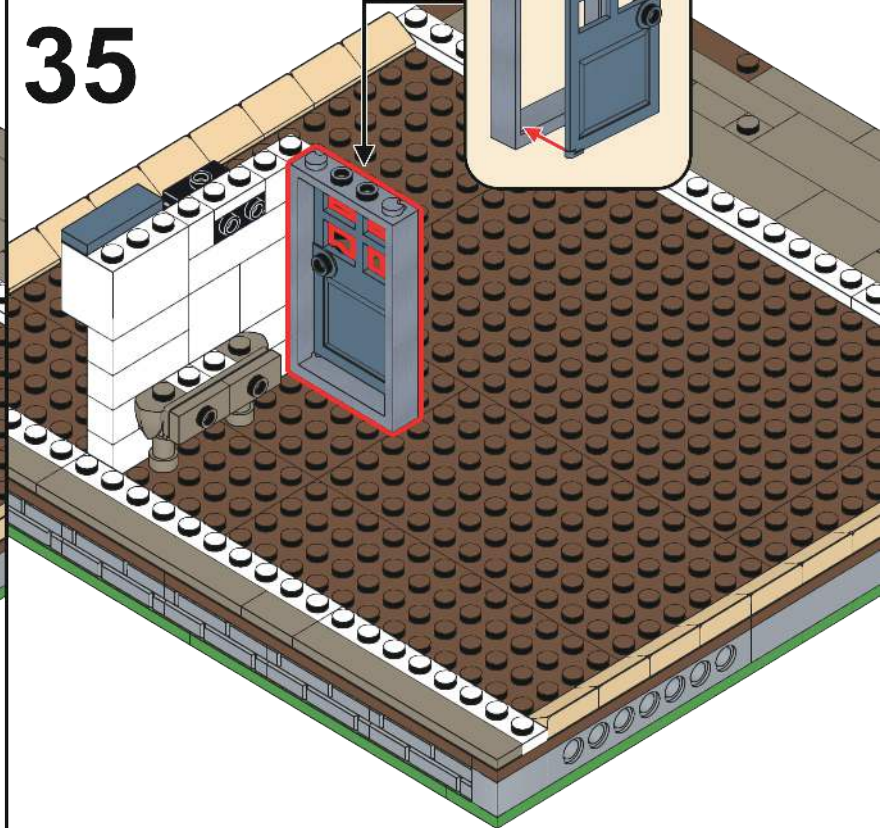
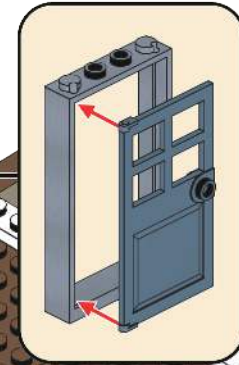

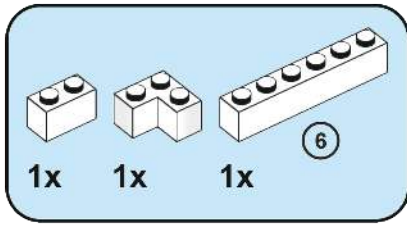

36

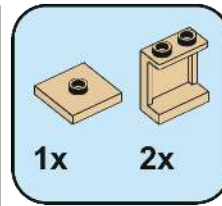
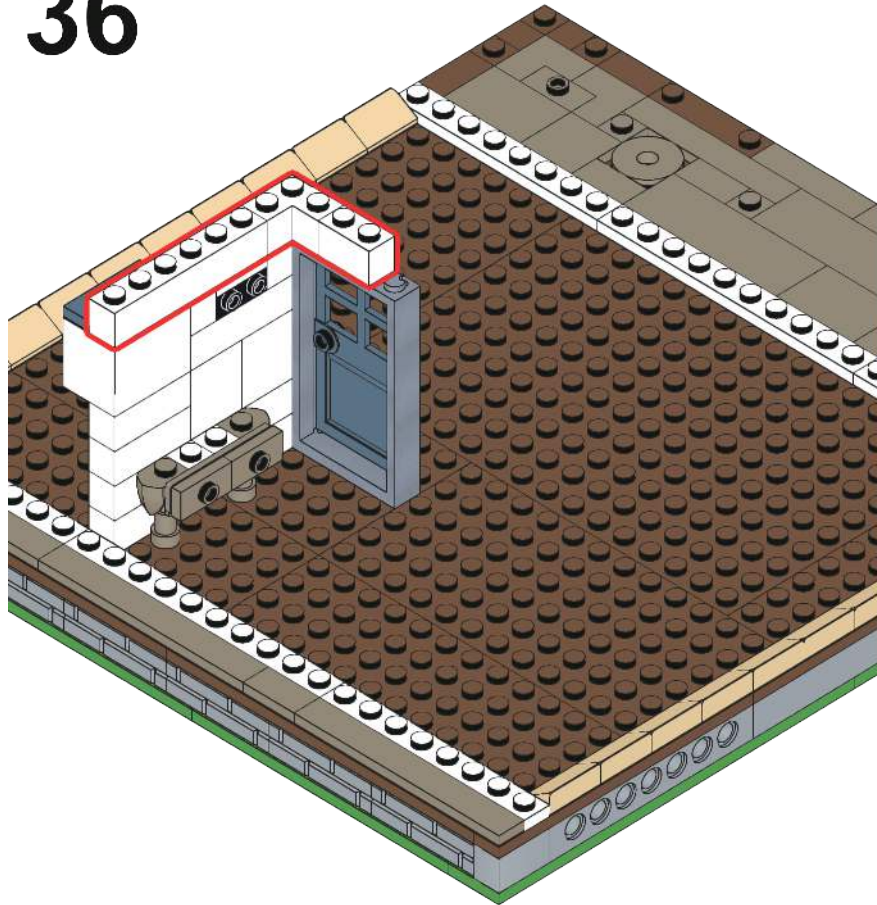

37

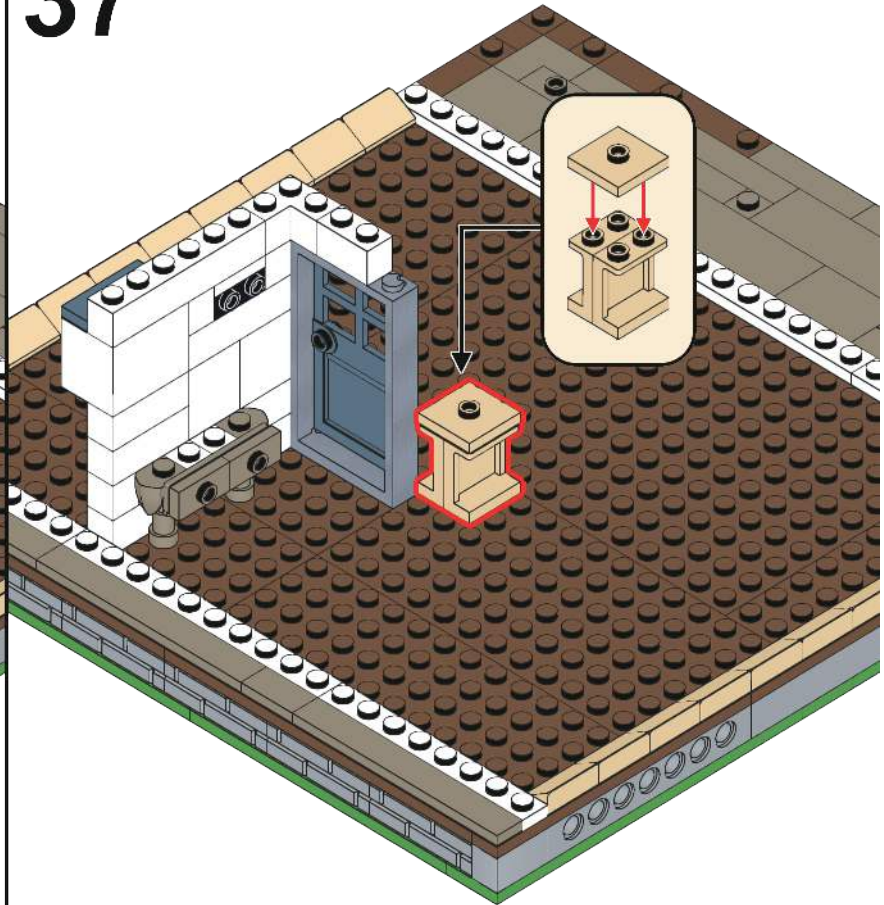

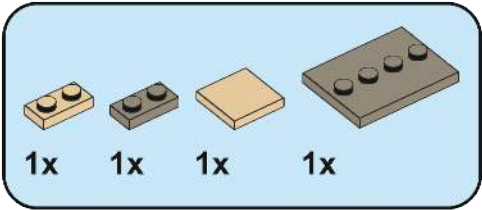

38

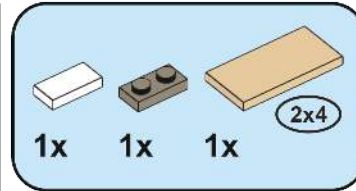
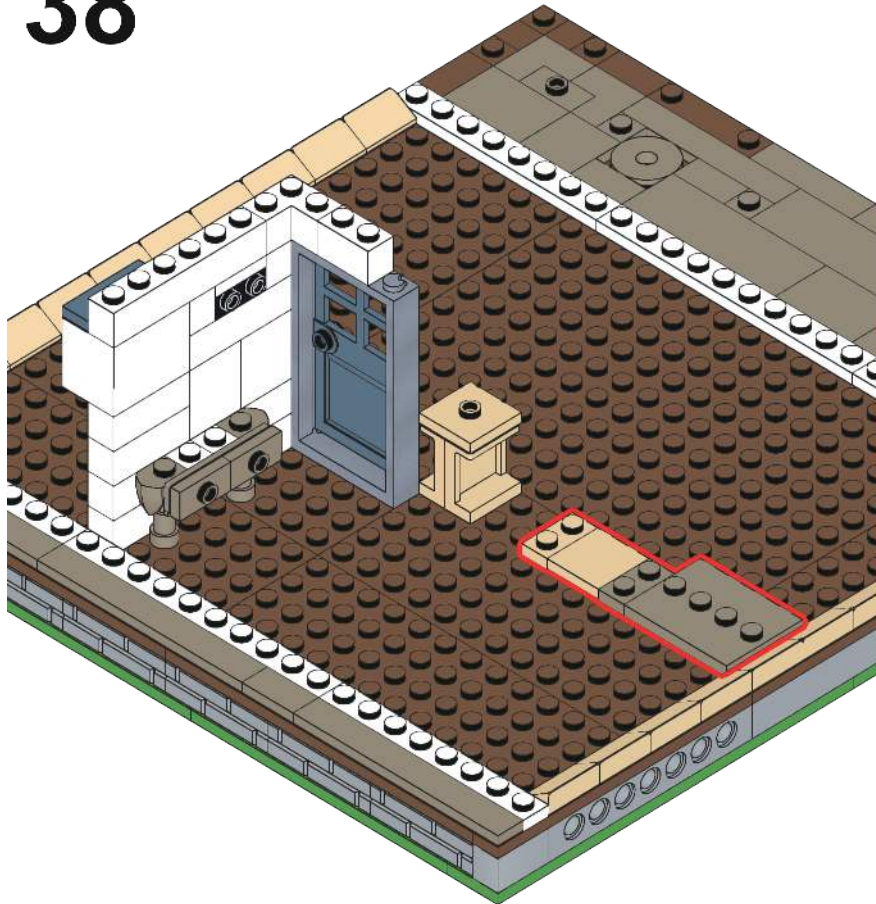

39

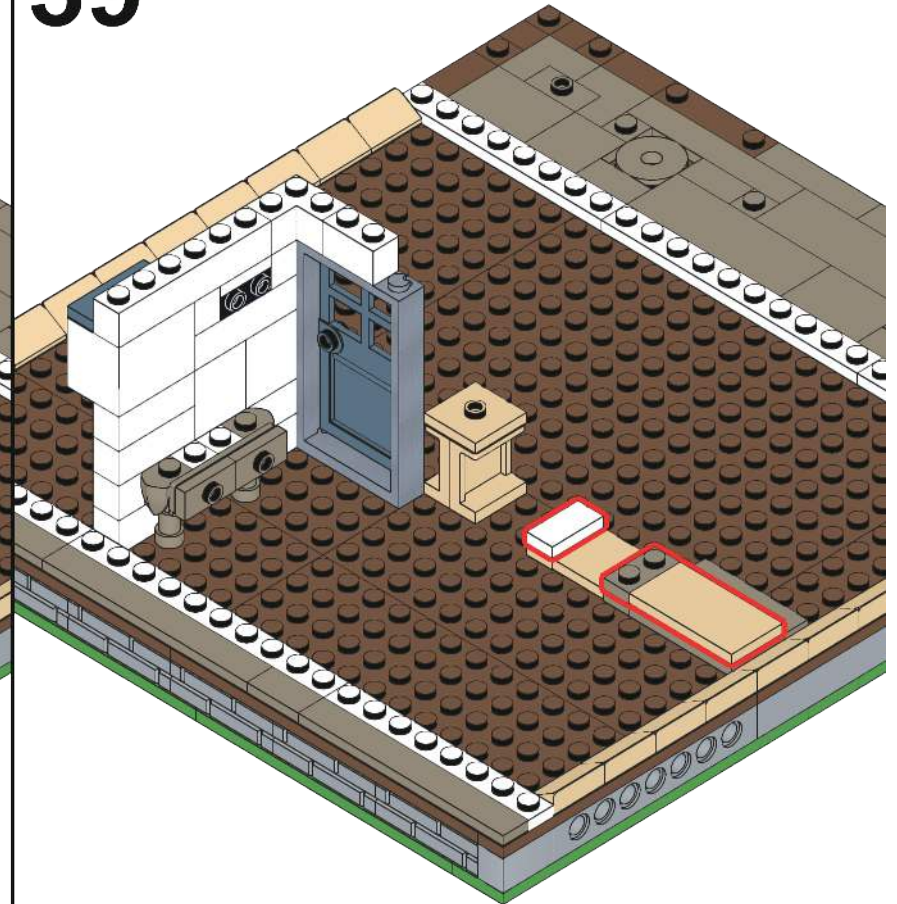

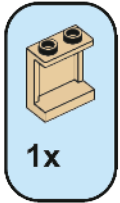
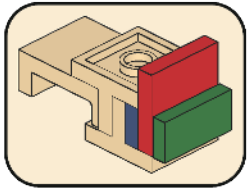

1x

40

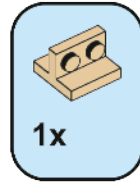
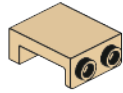

1x

41

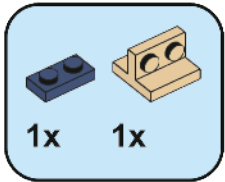
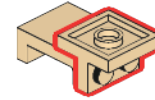

1x

1x

42

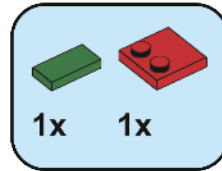
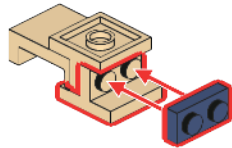

1x

1x

43

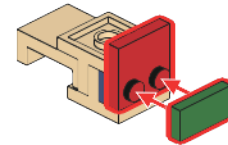

44

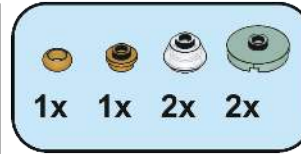
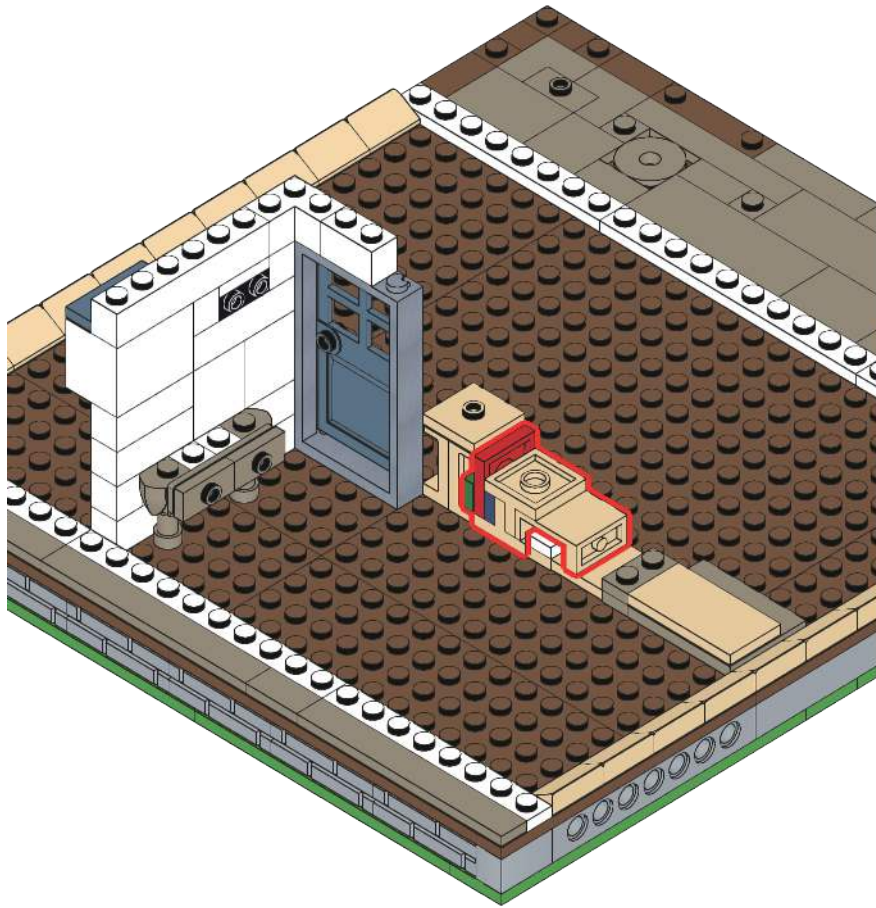

45

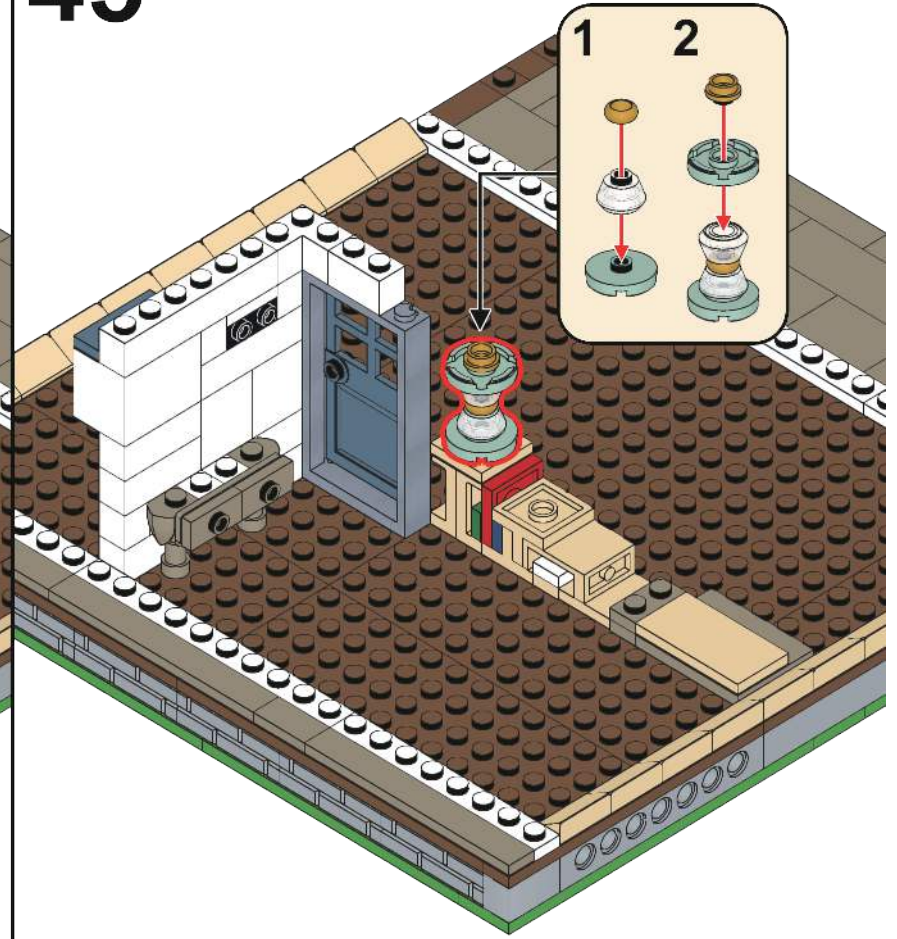

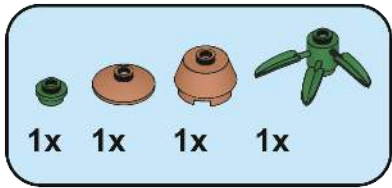

46

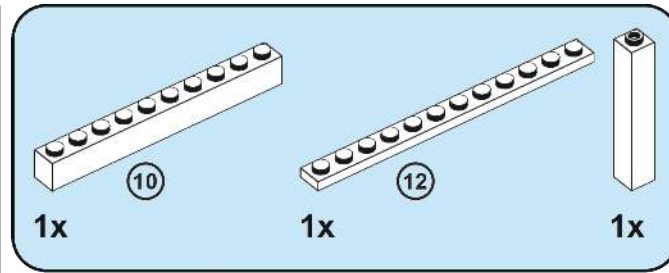
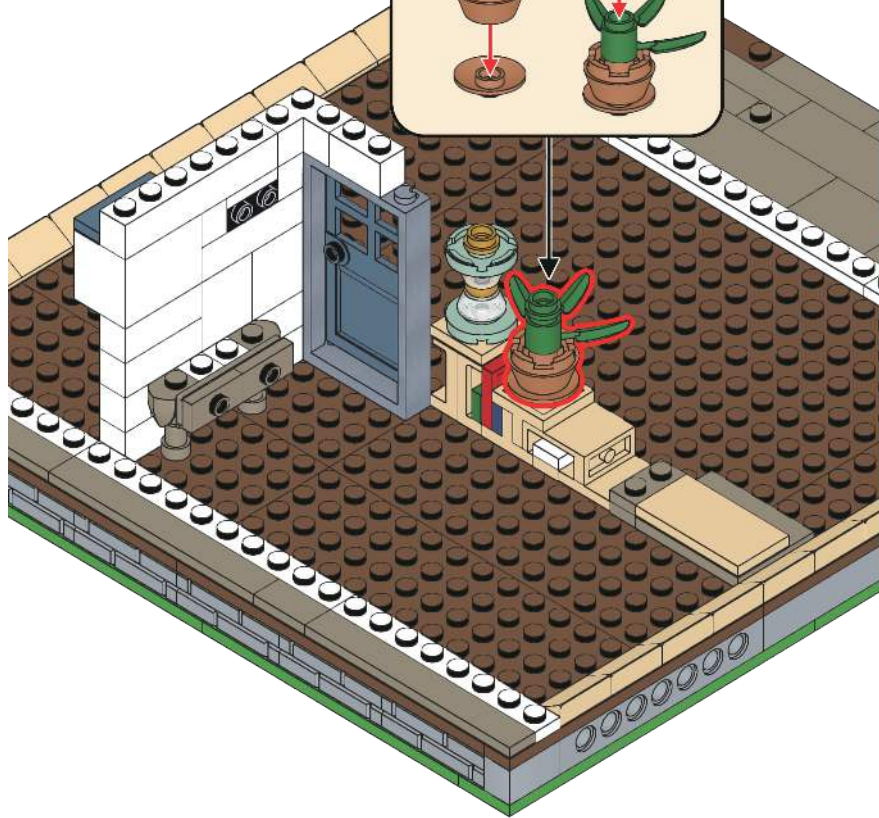
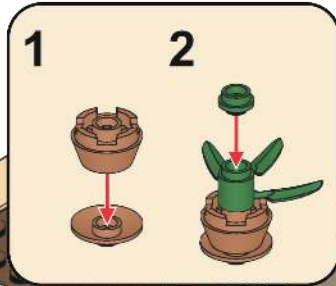

47

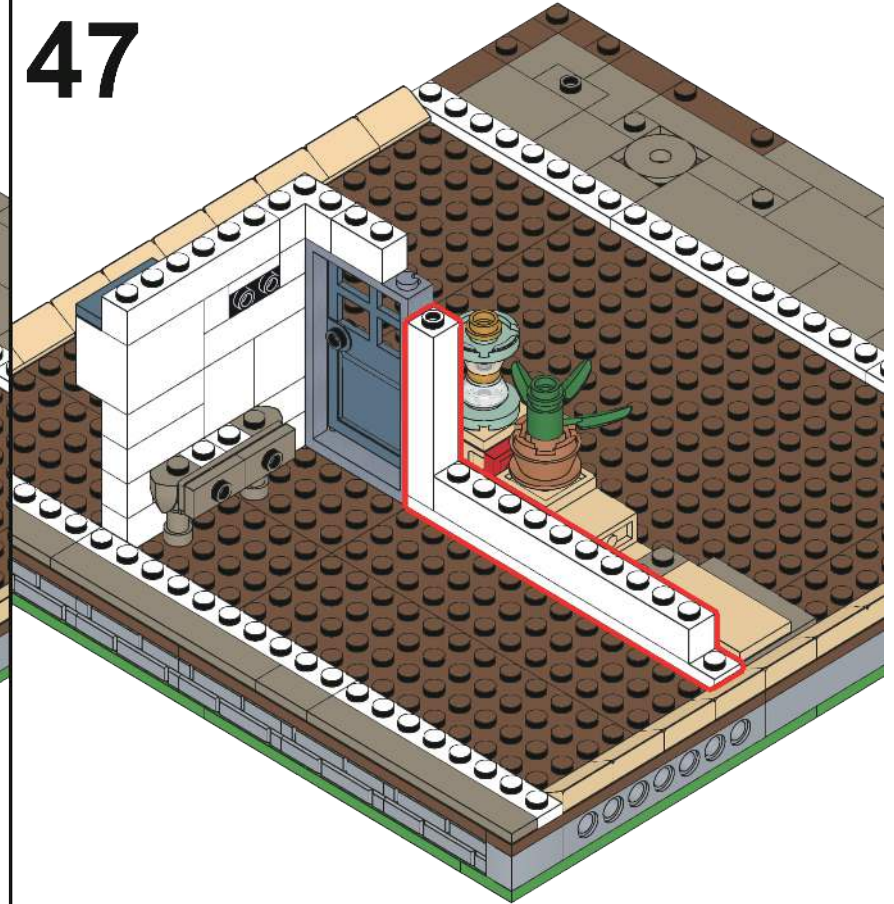

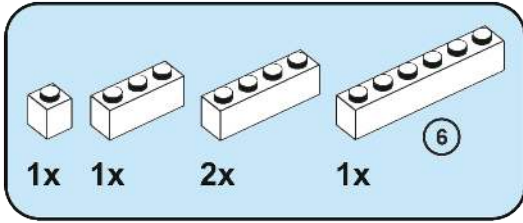

48

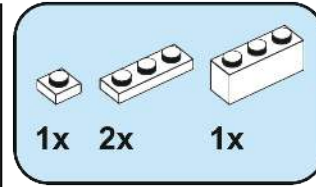
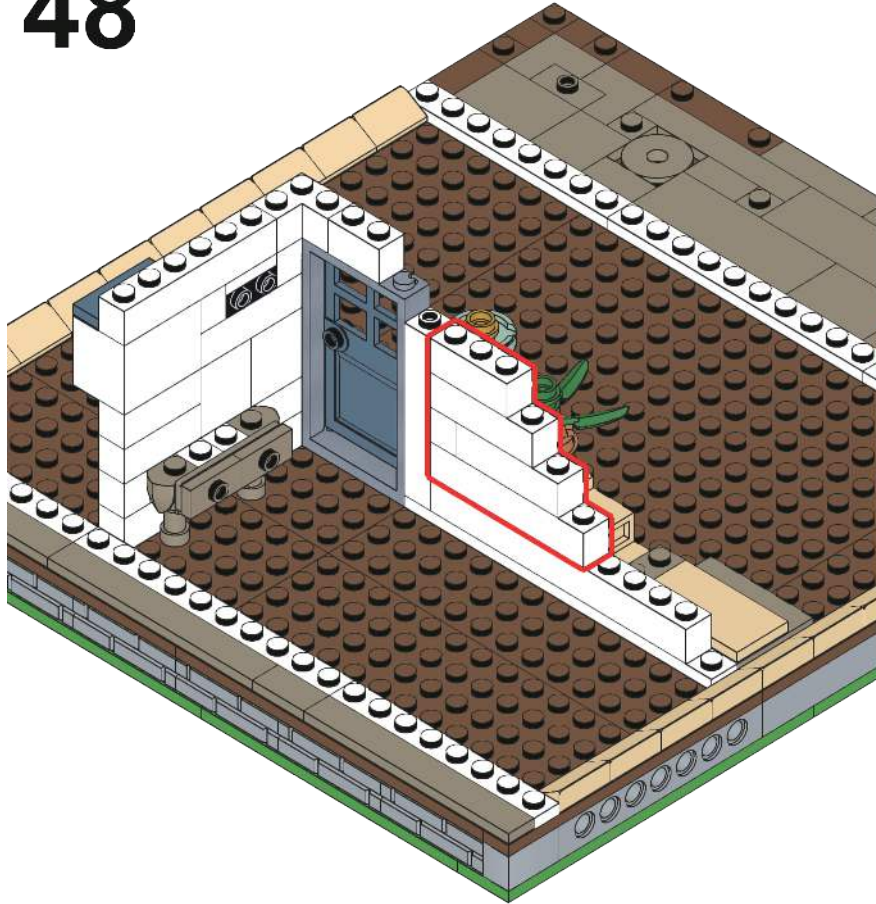

49

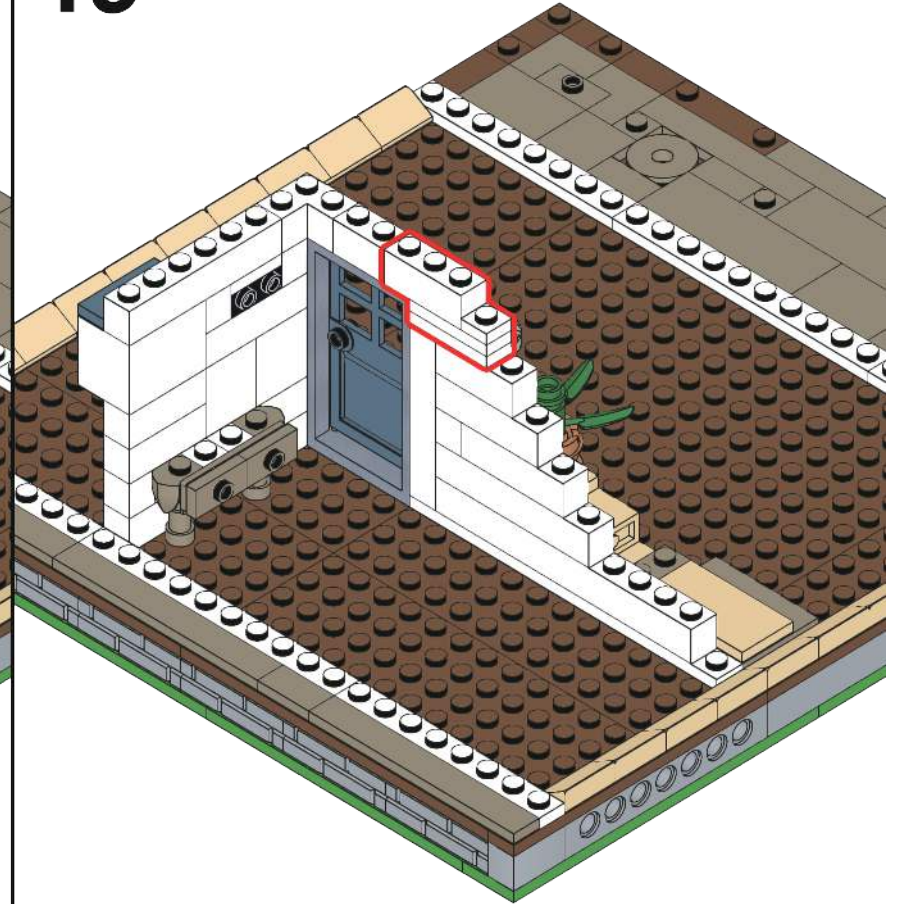

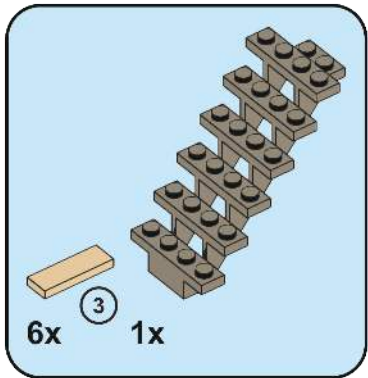

50

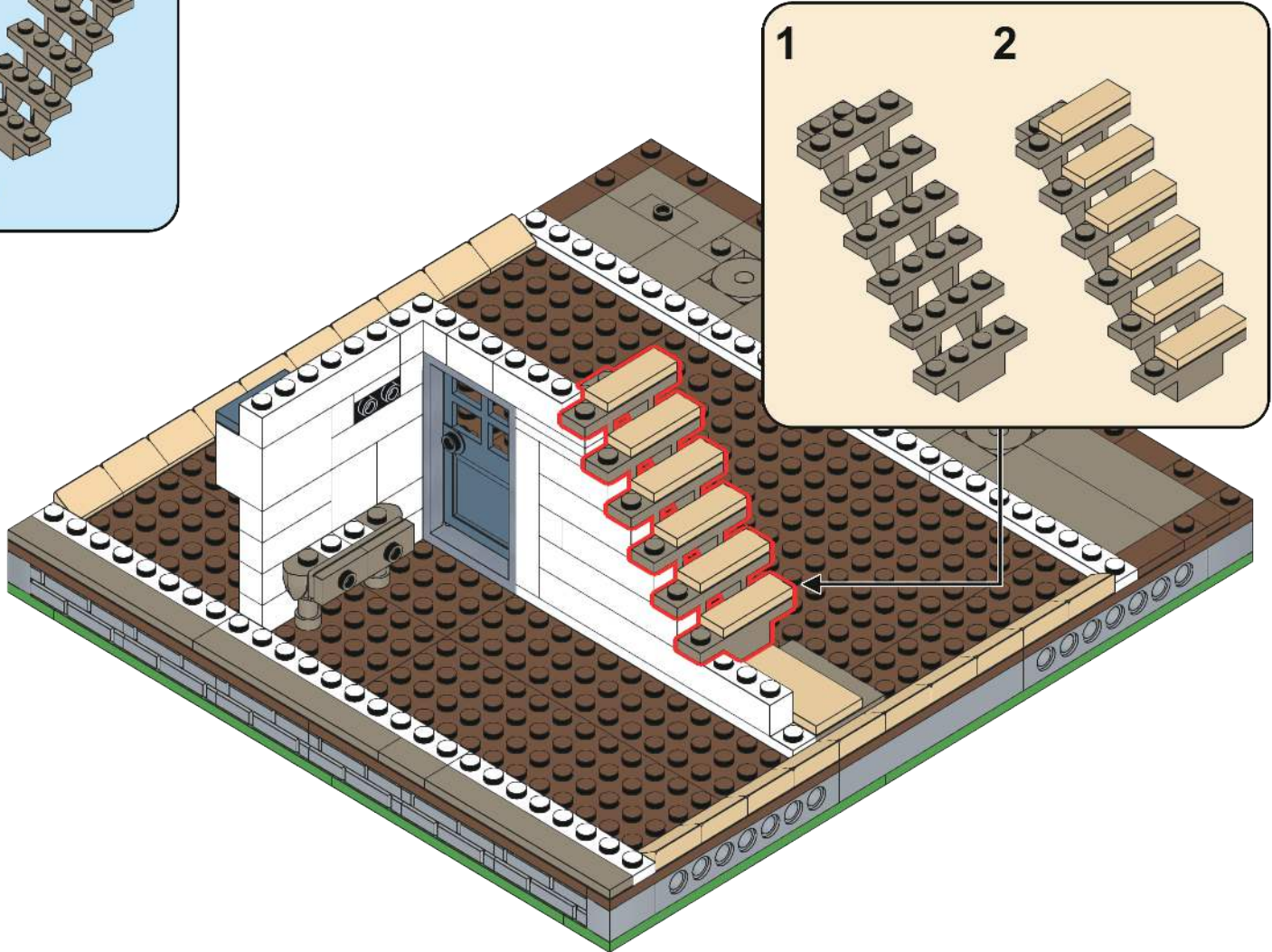

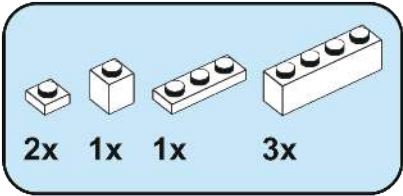

51

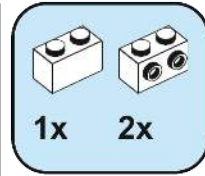
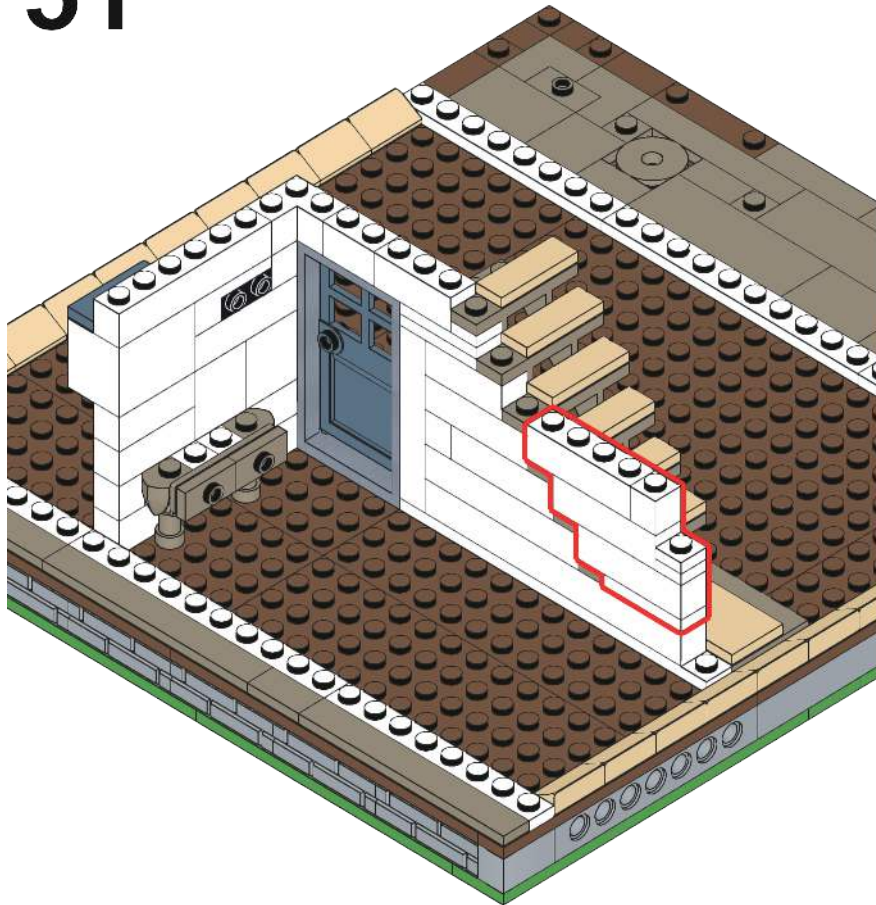

52

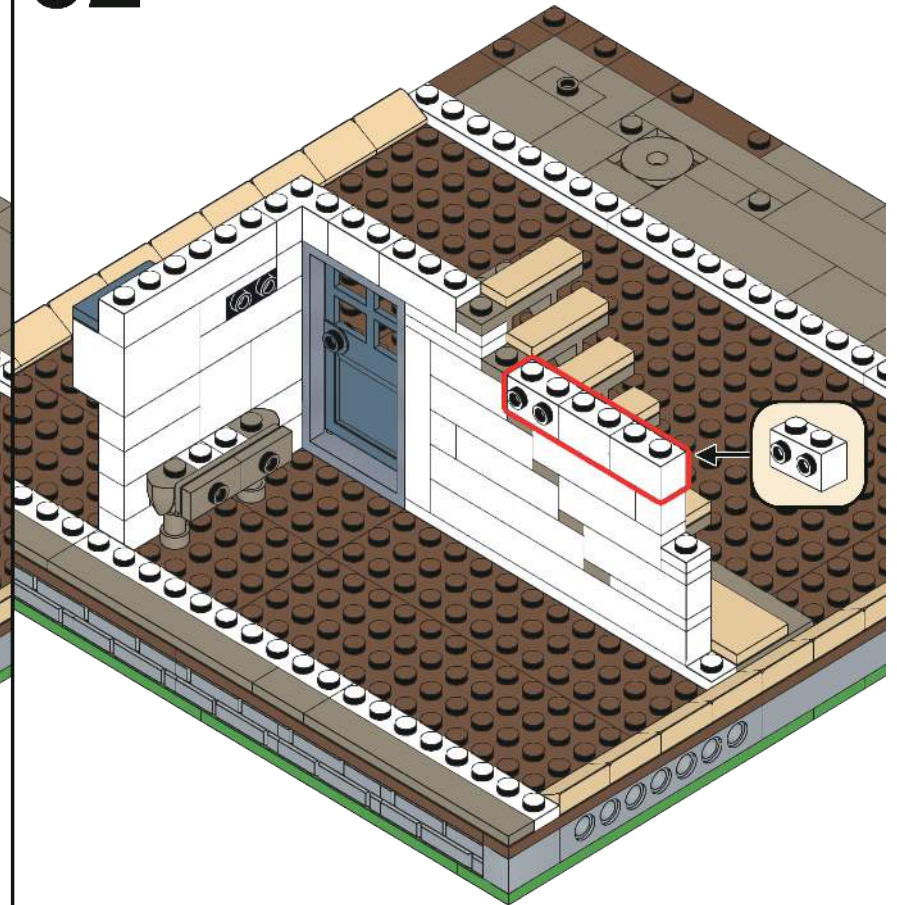

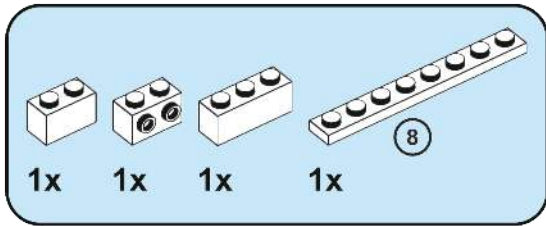

53

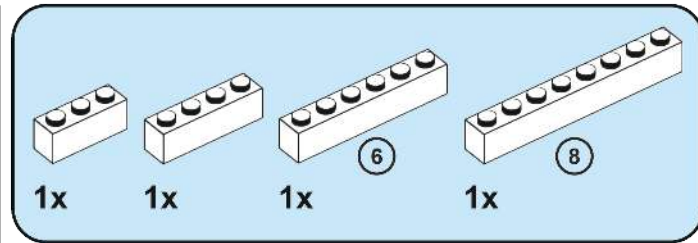
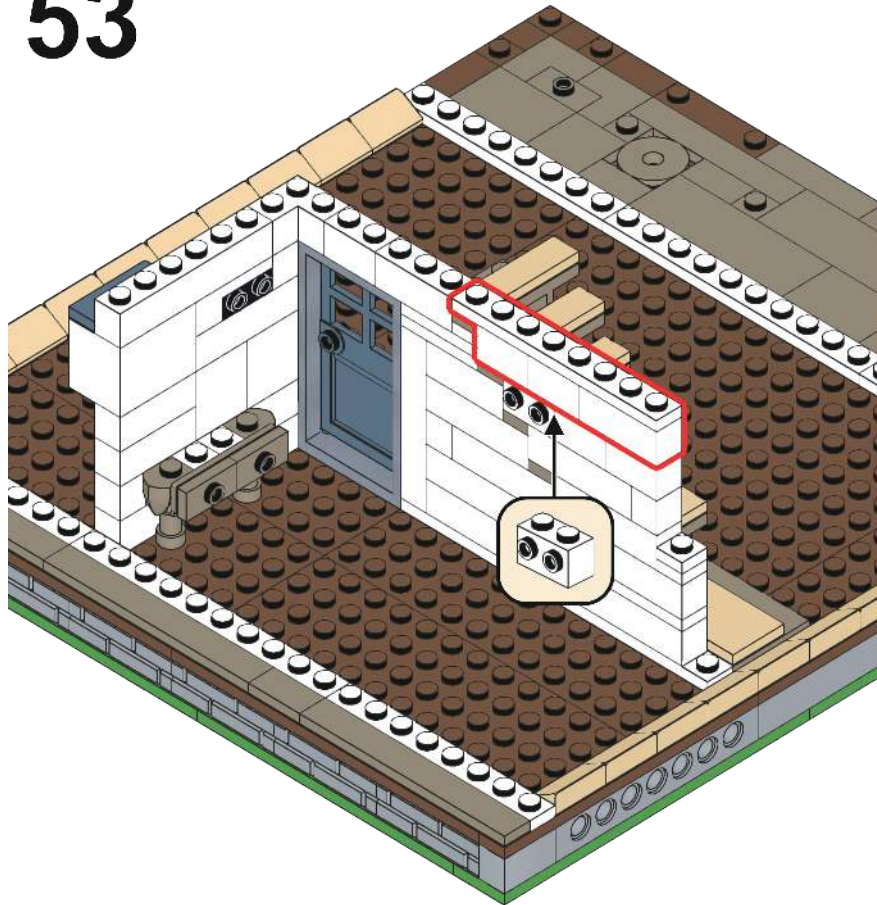

54

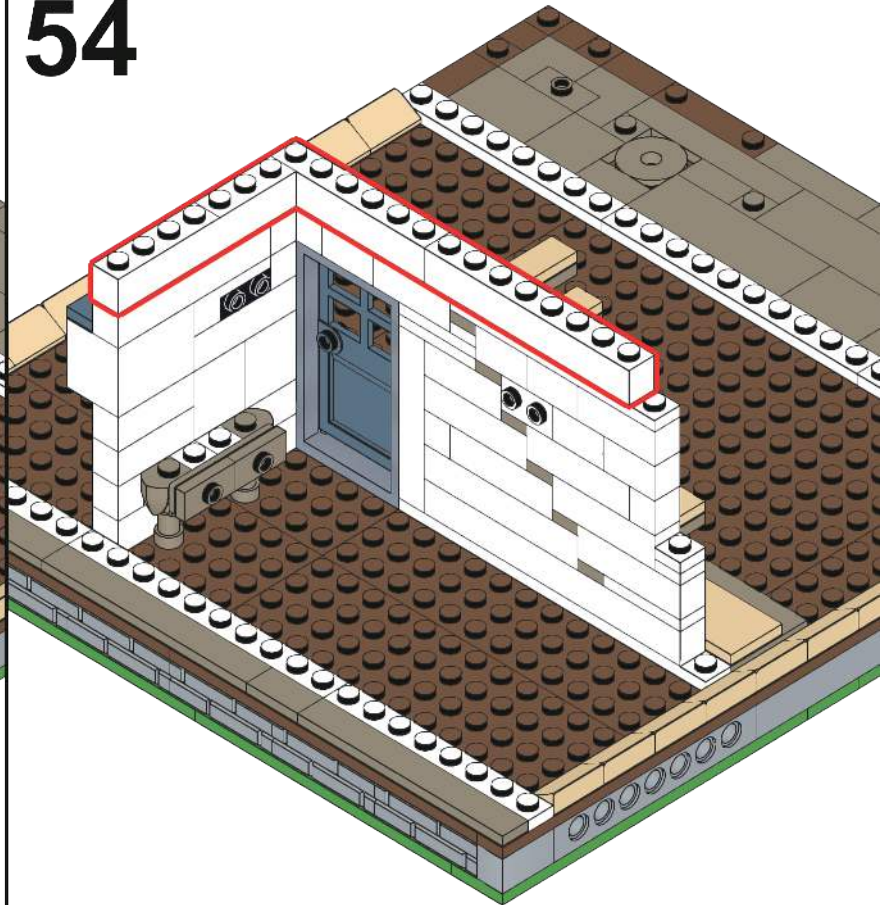

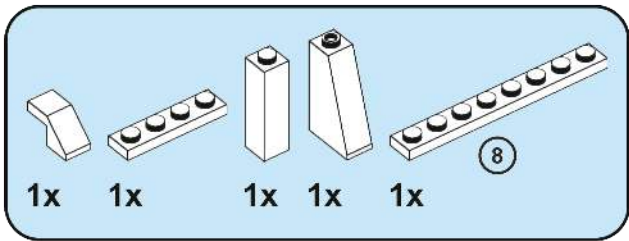

55

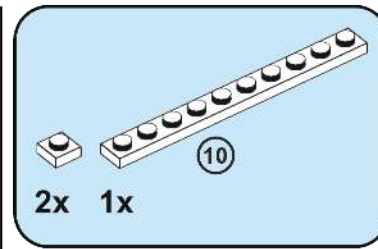
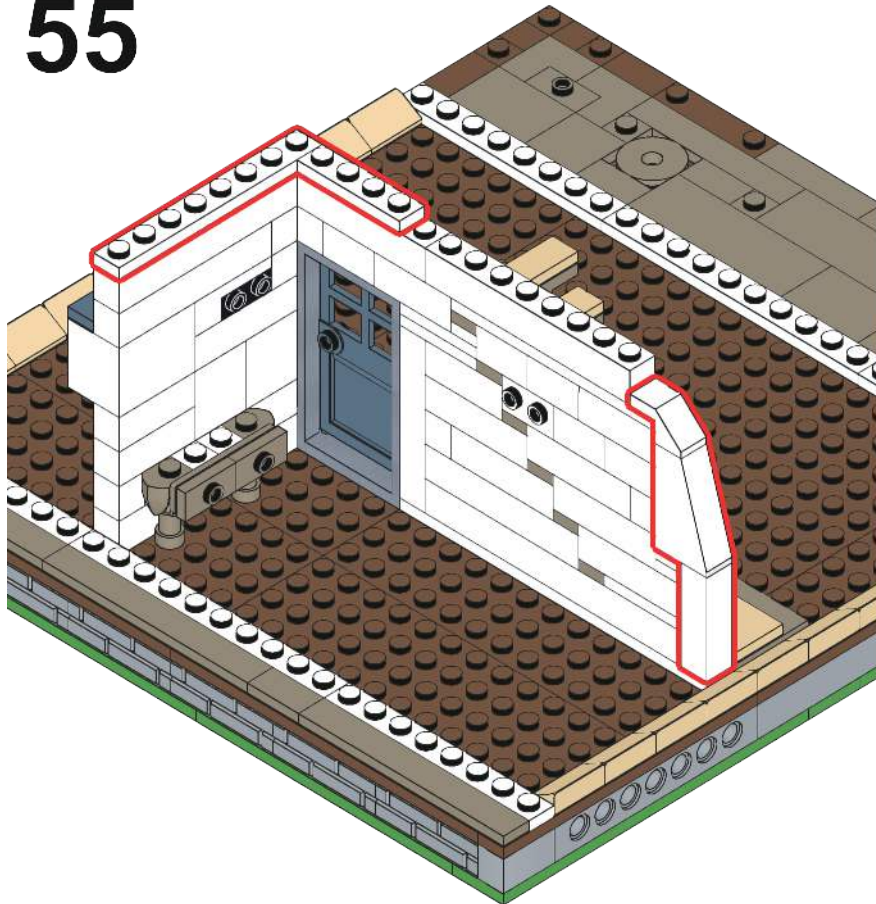

56

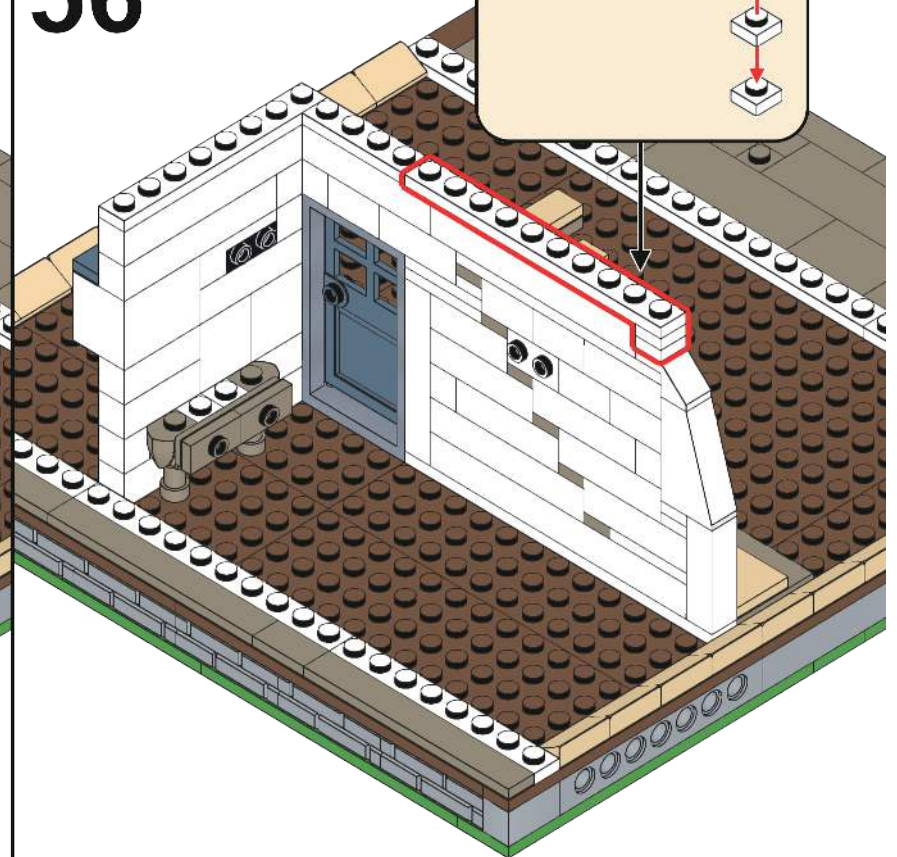

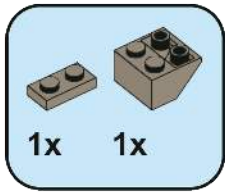

57

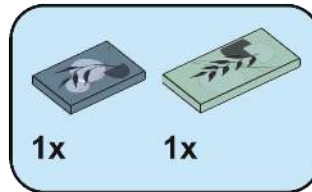
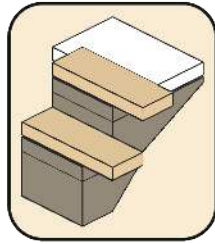

60

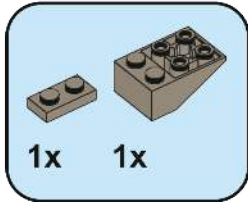
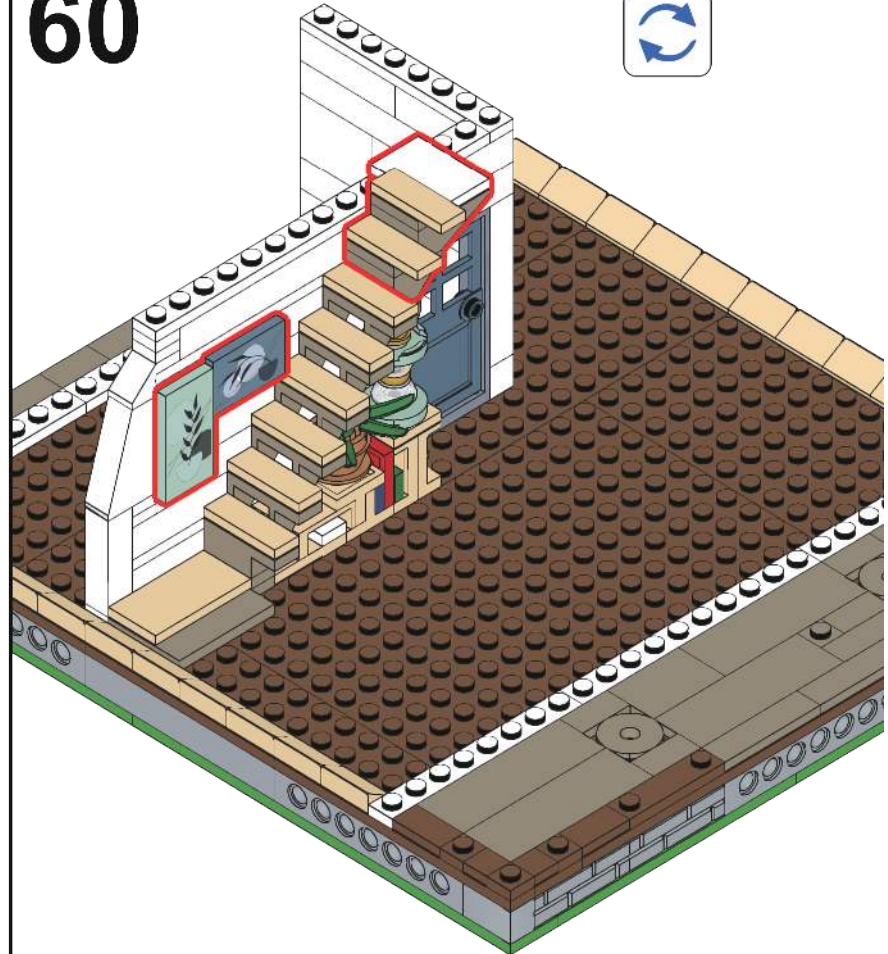

58

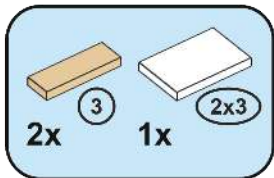
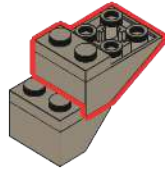

59

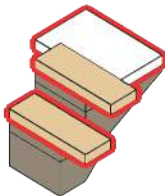

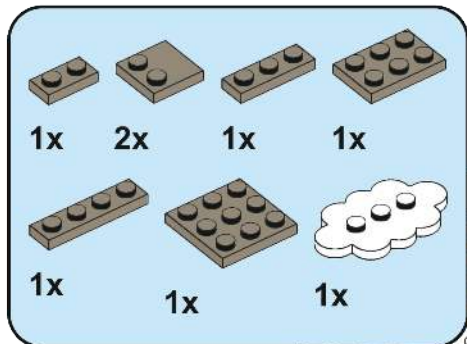
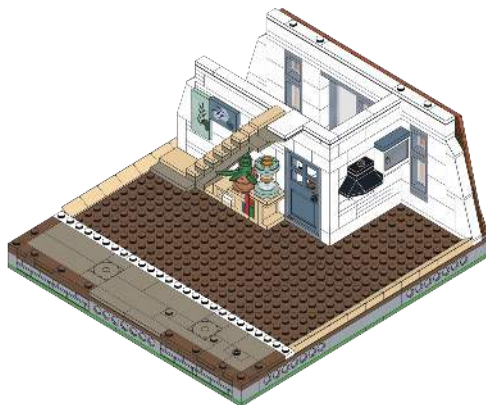

63

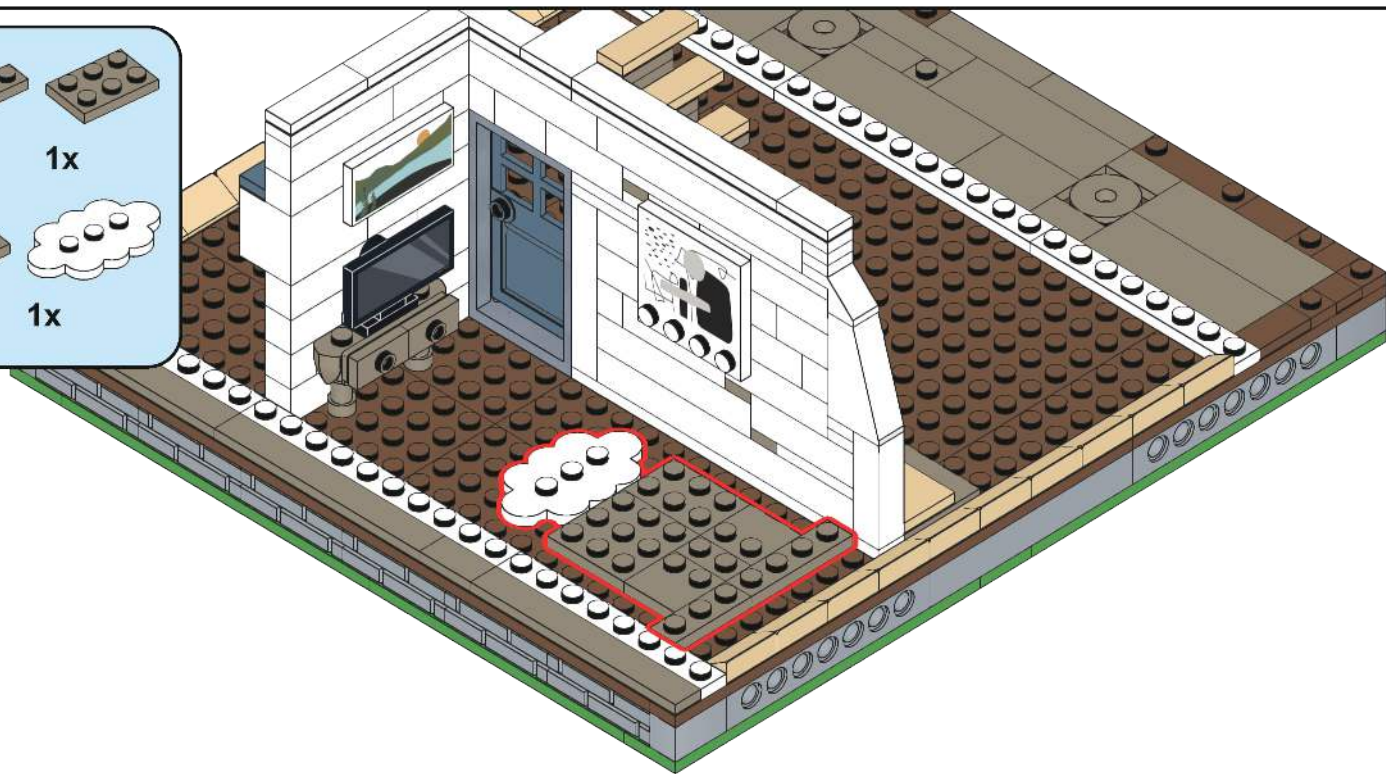



64

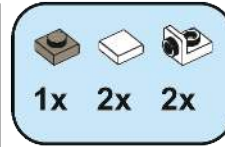
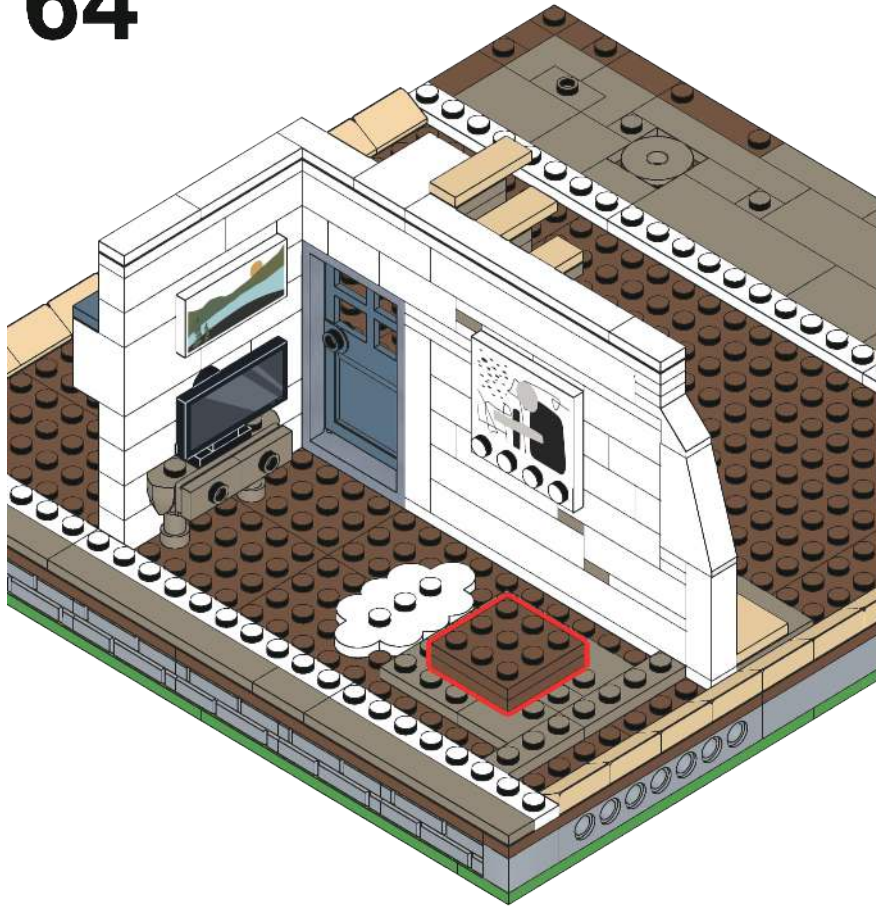

65

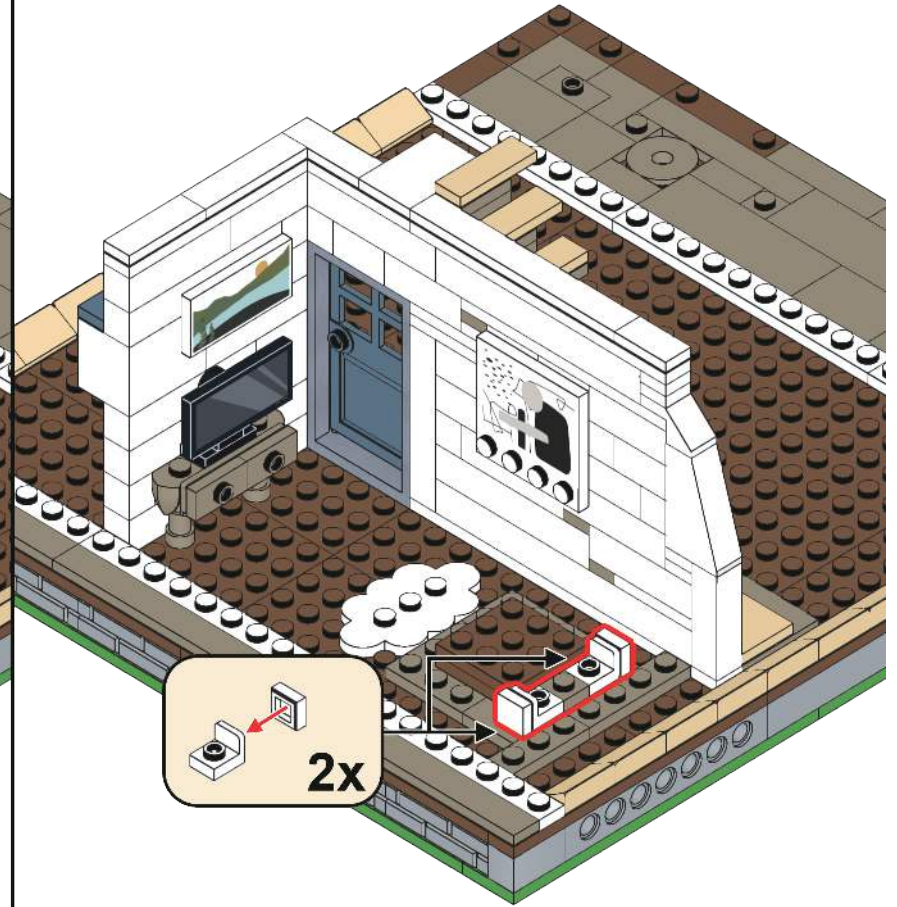

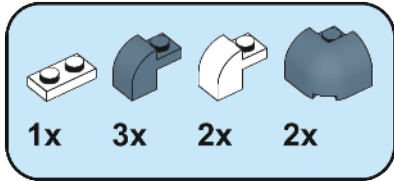

66

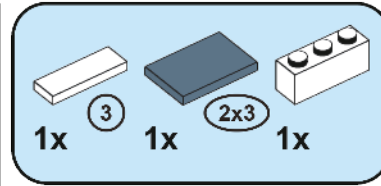
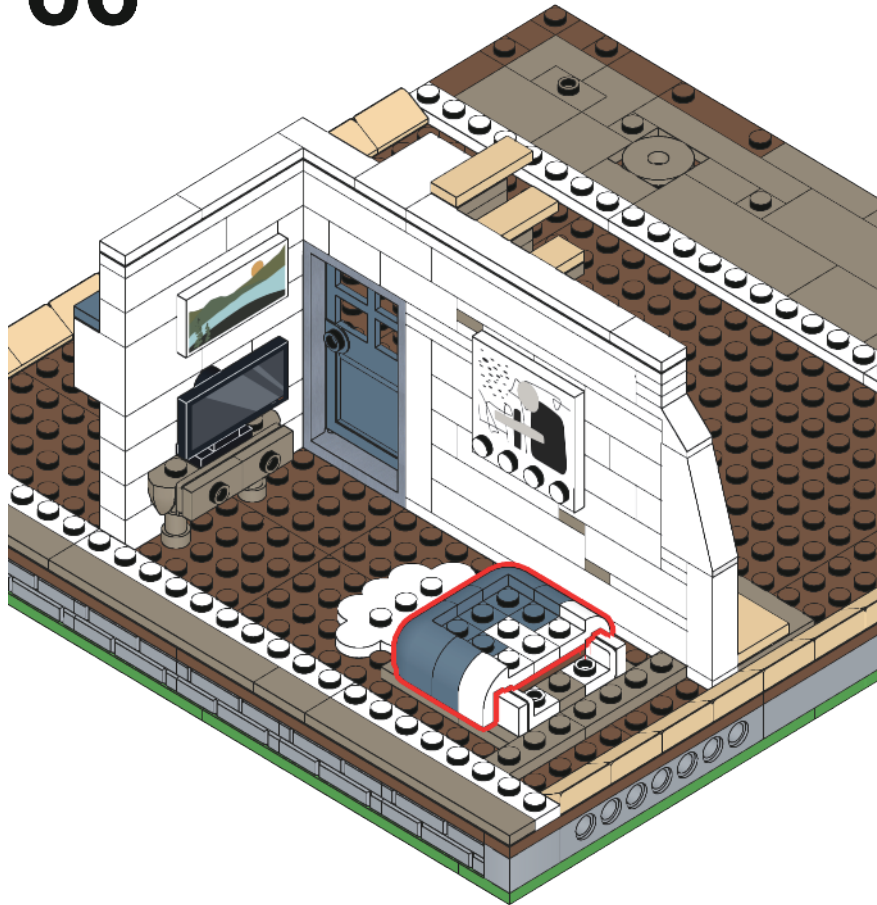

67

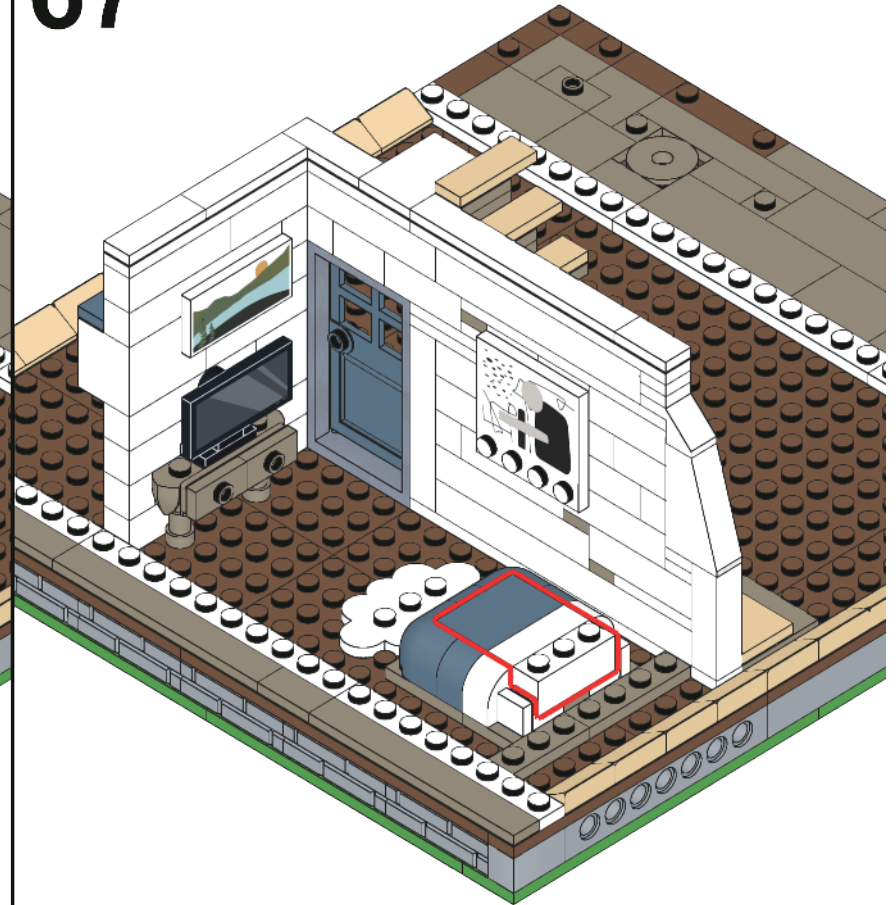

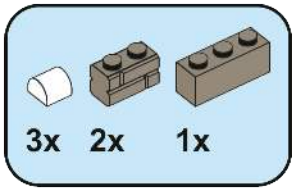

68

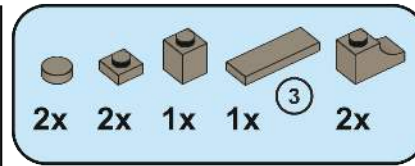
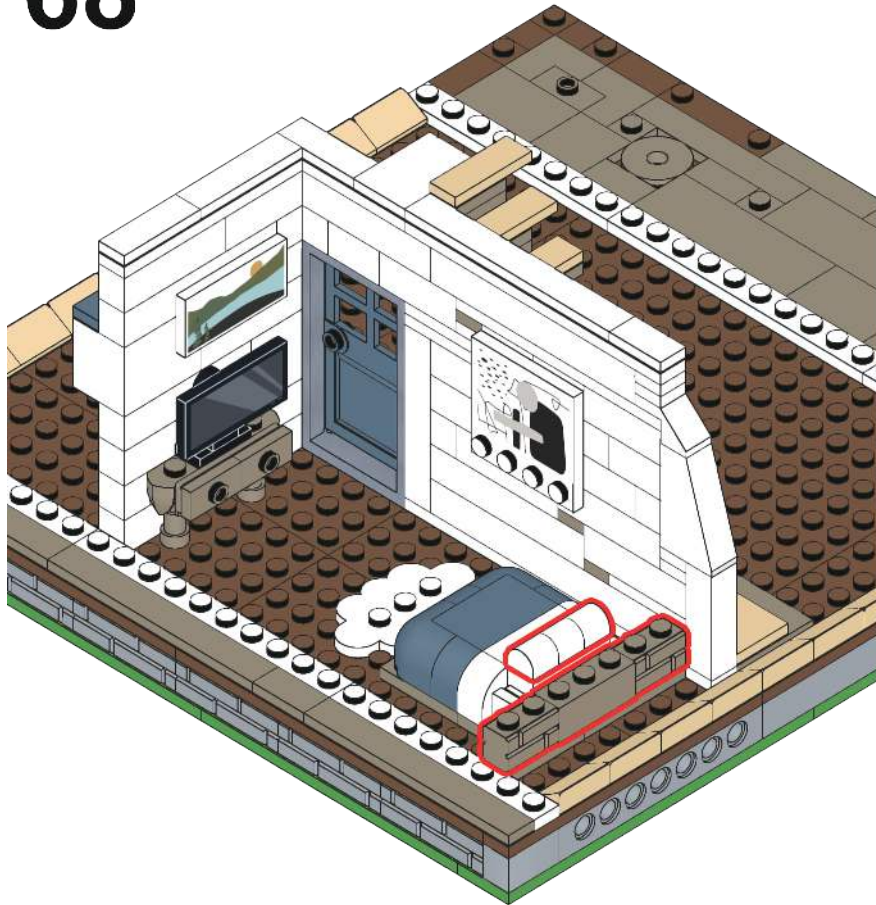

69

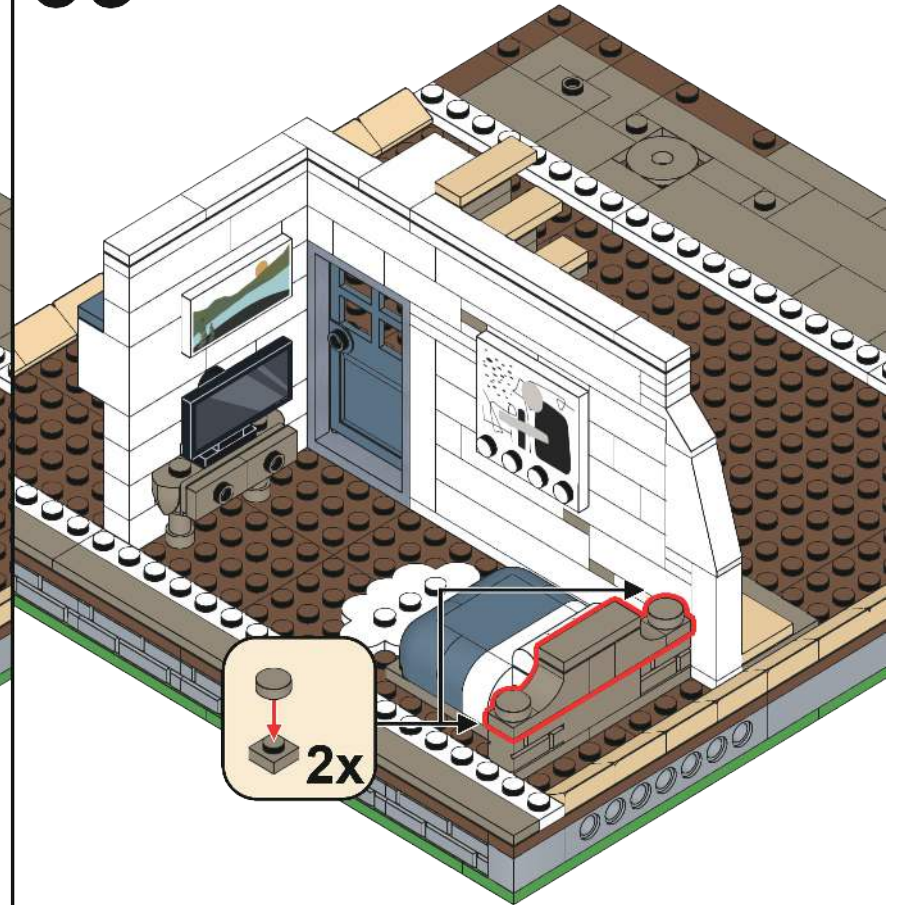

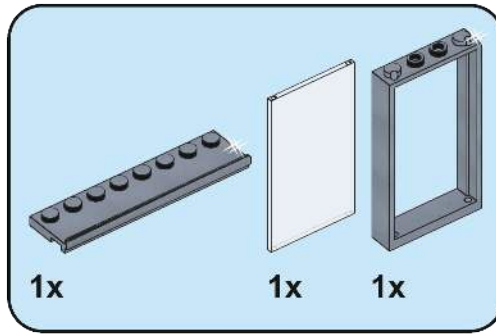
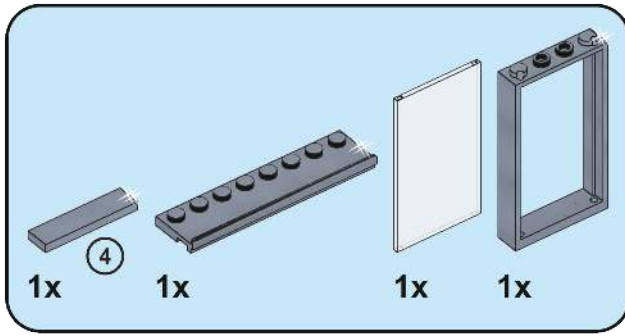

70

71

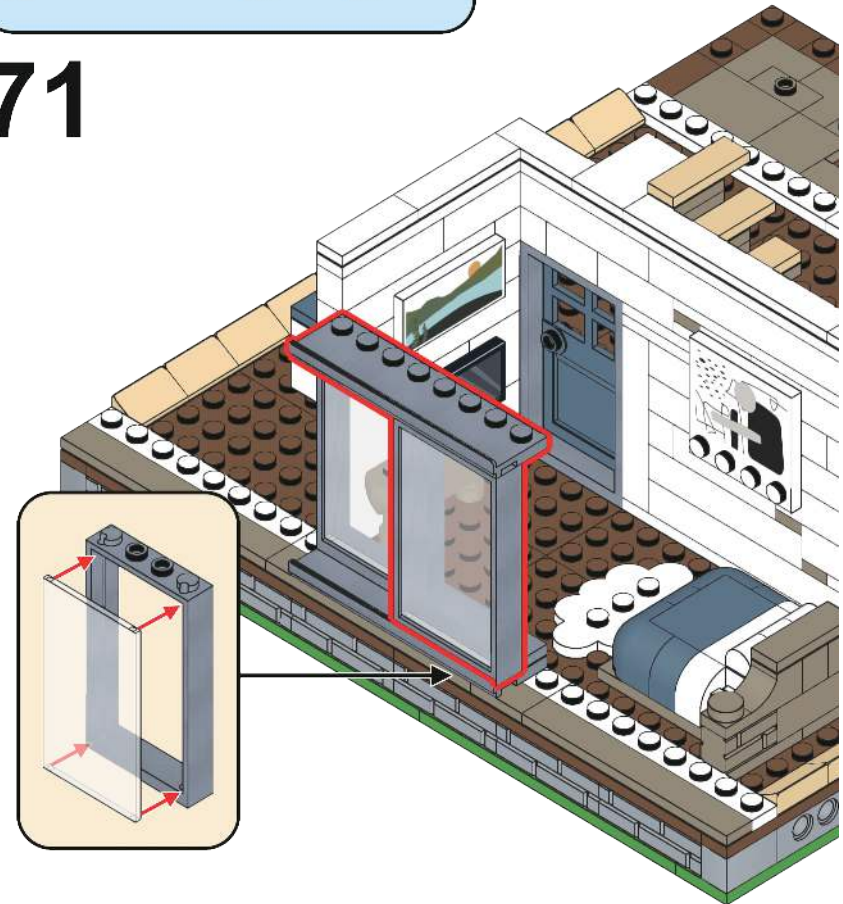
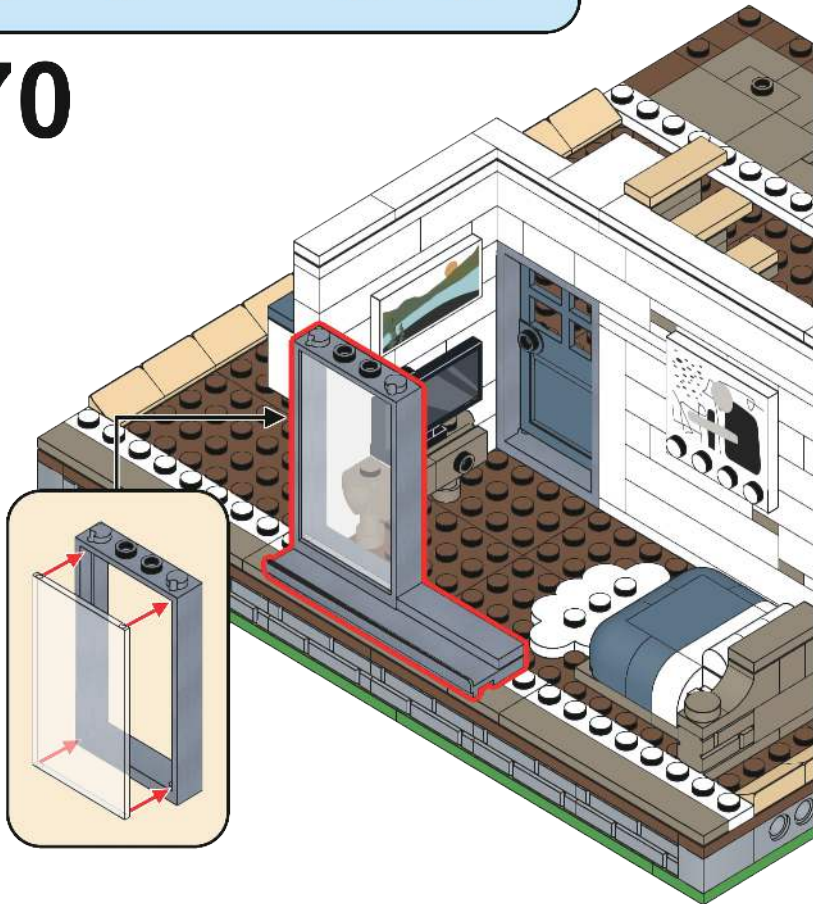

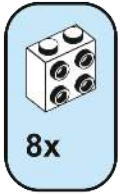

8x

72

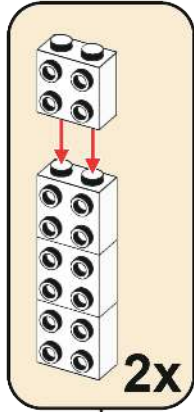

2x

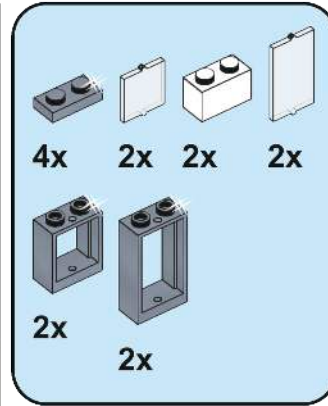
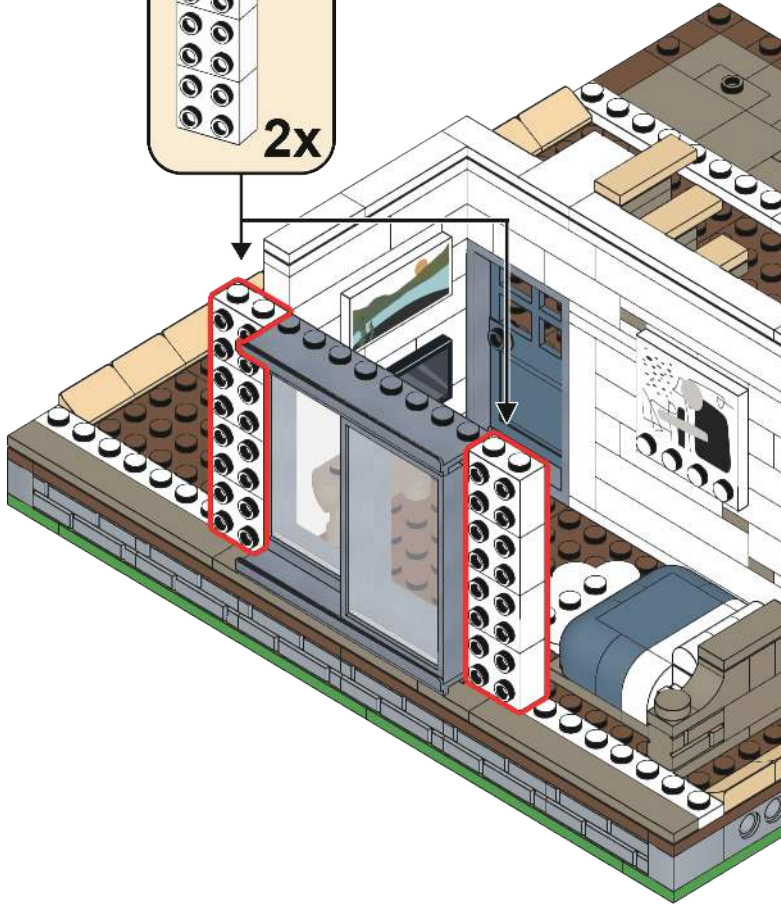

4x

2x

2x

2x

2x

2x

73

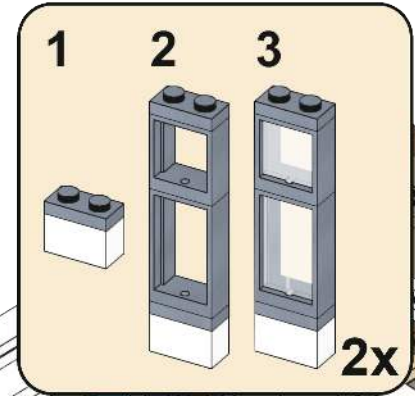

1

2

3

2x

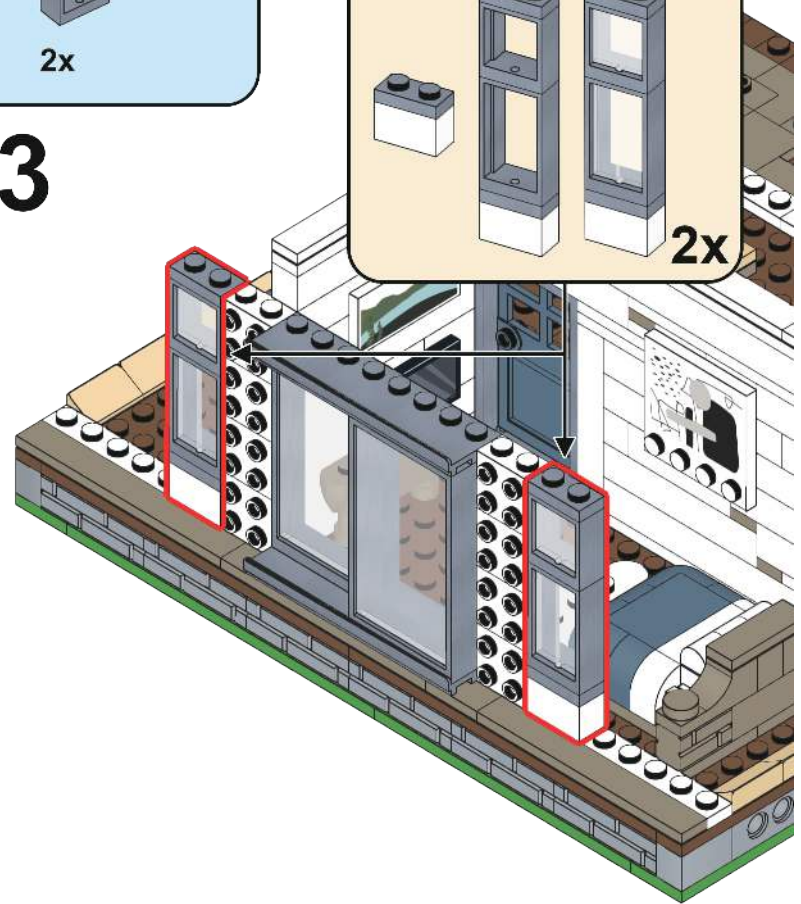

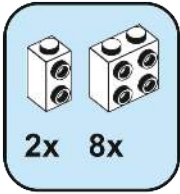

74

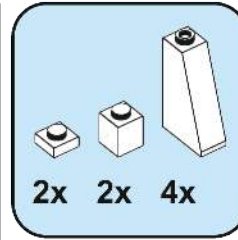
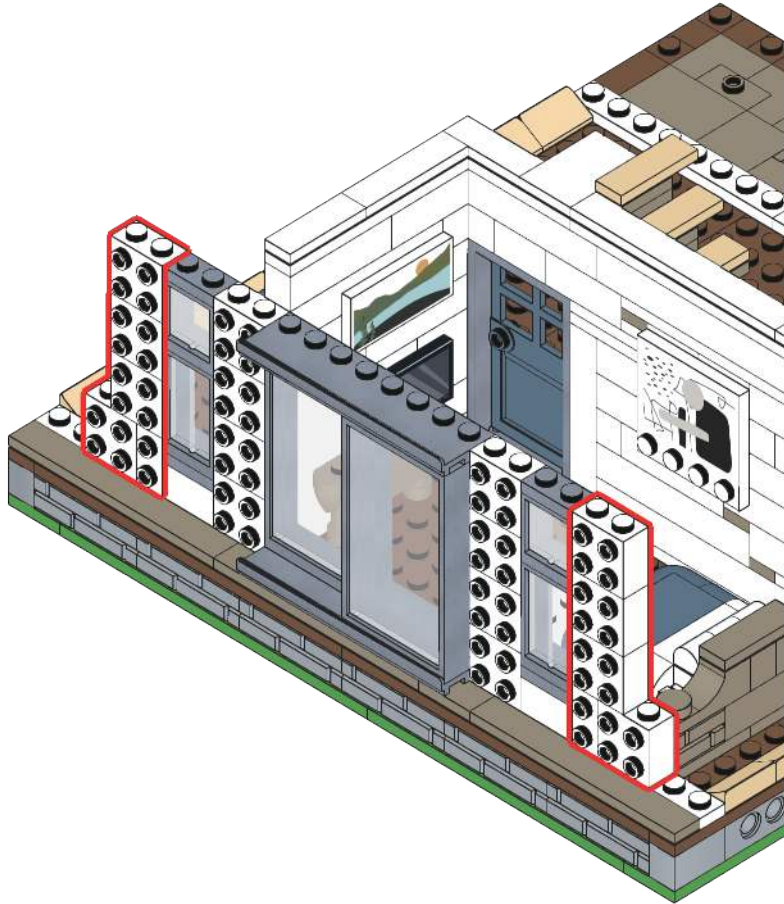

75

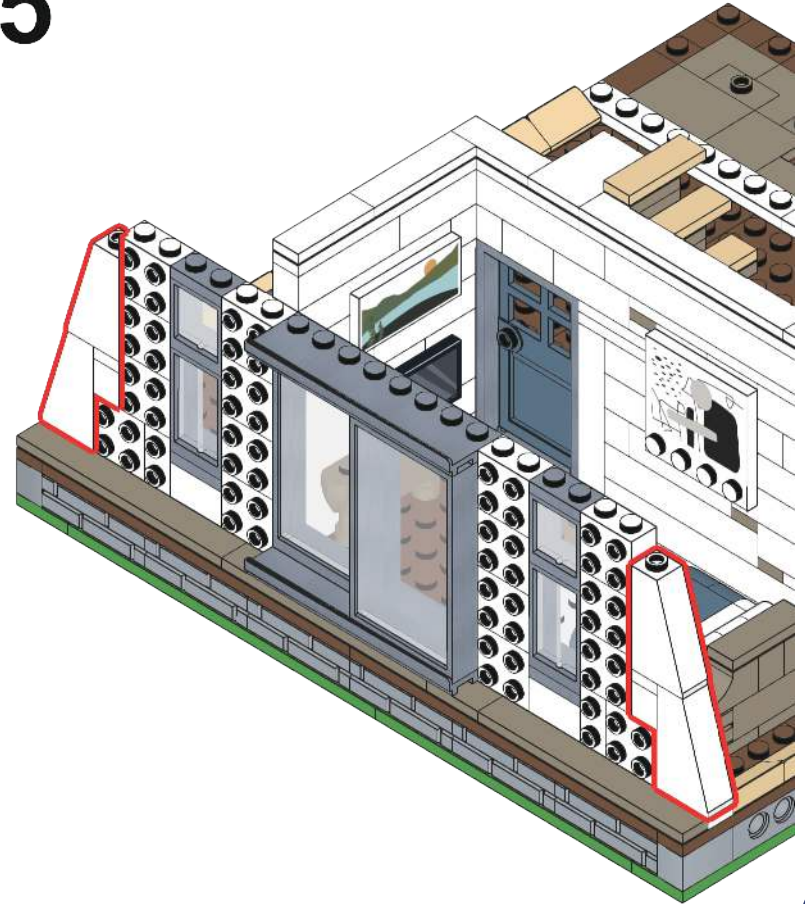

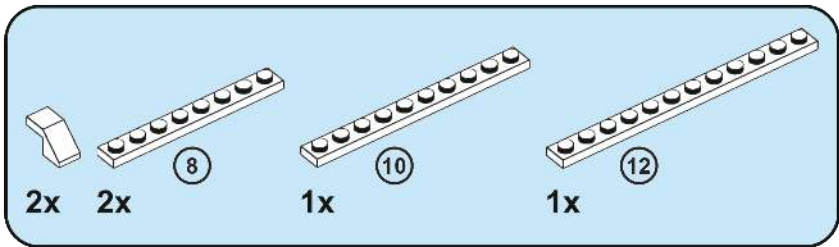

76

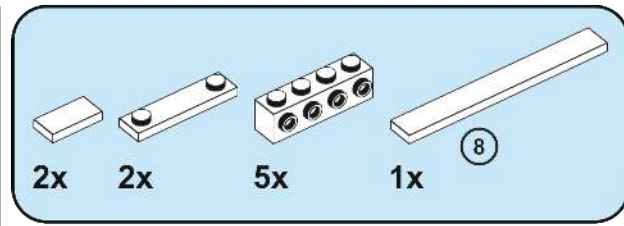
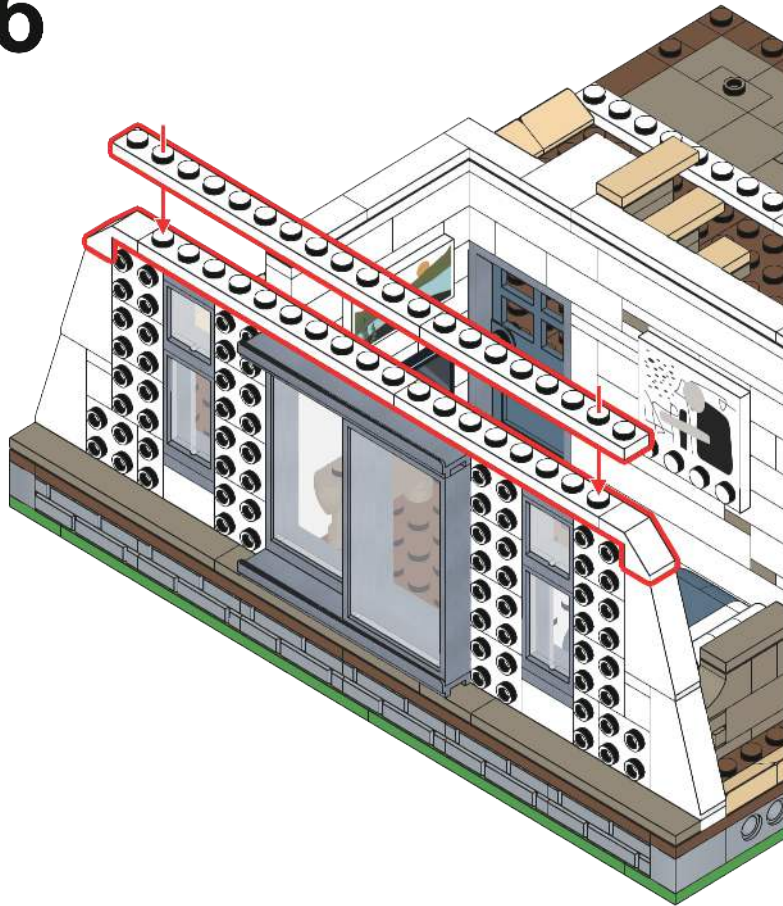

77

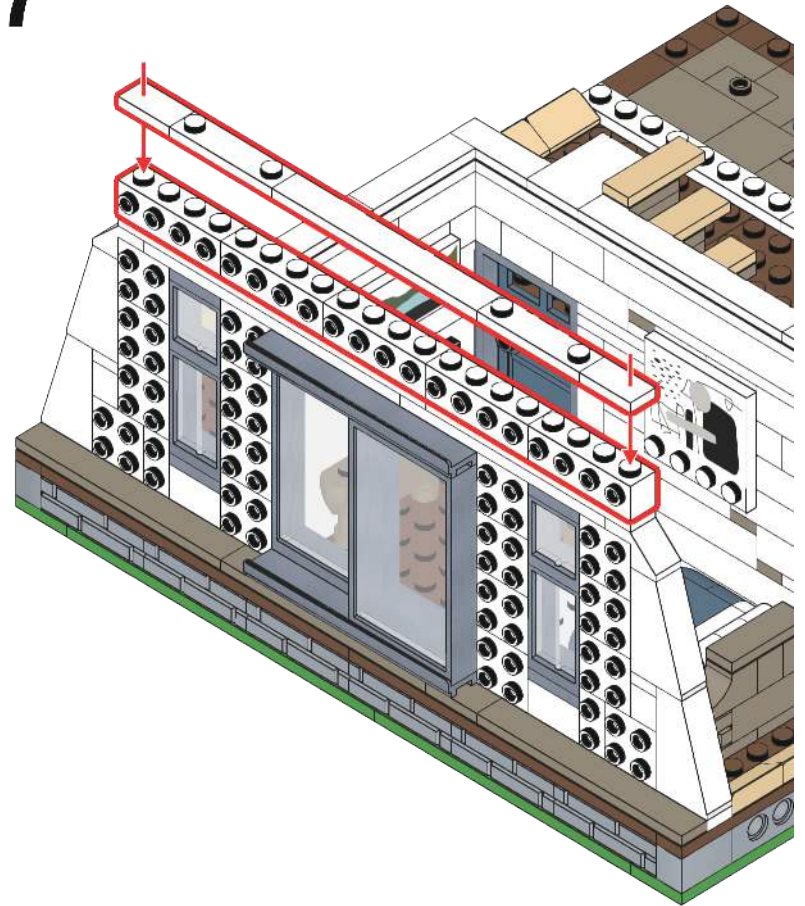

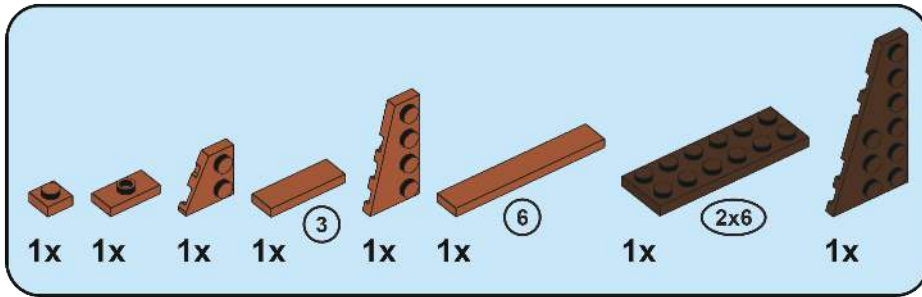

78

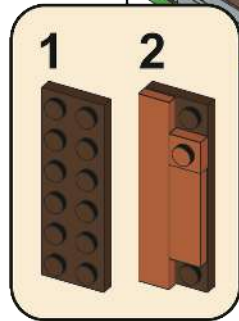
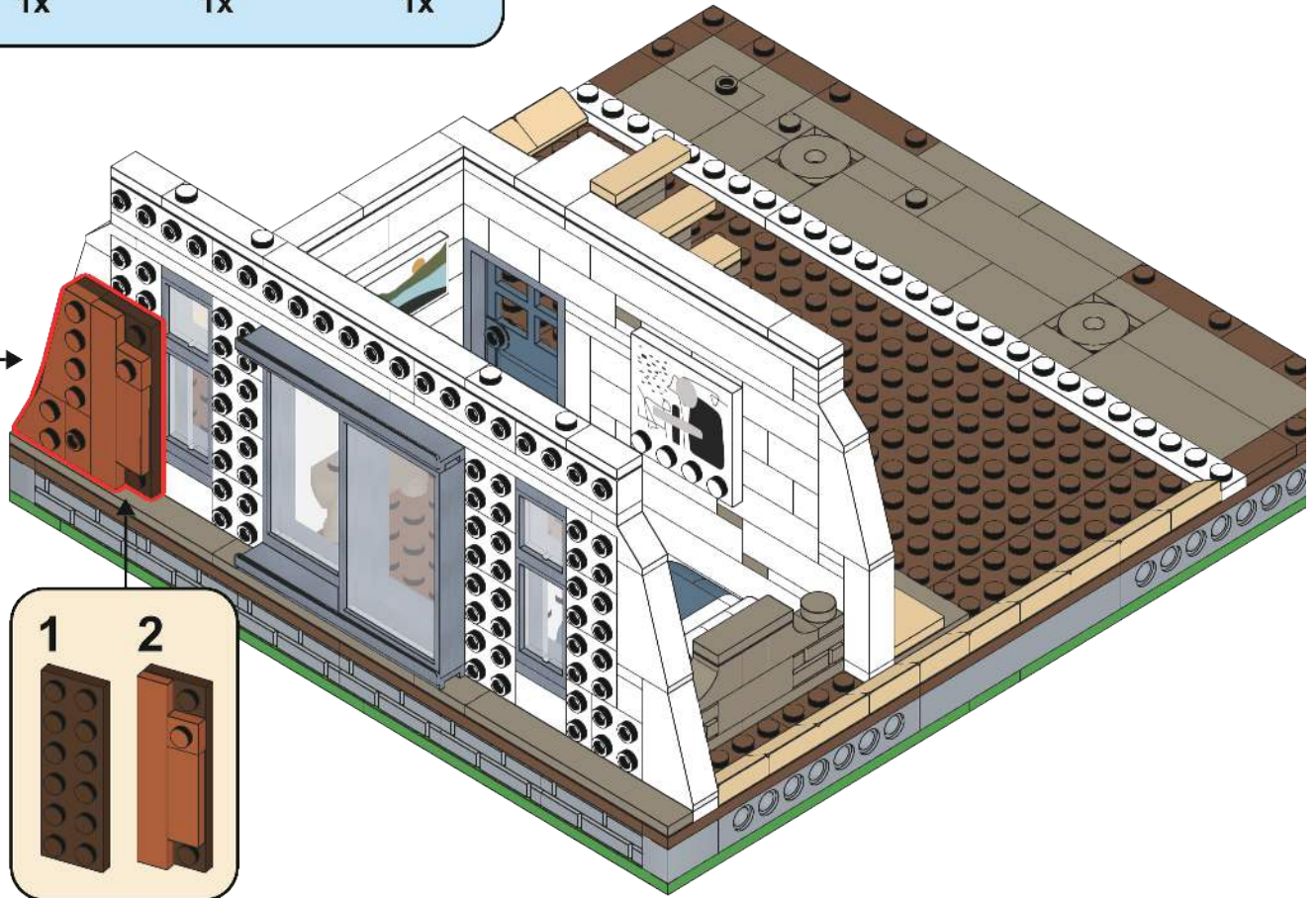
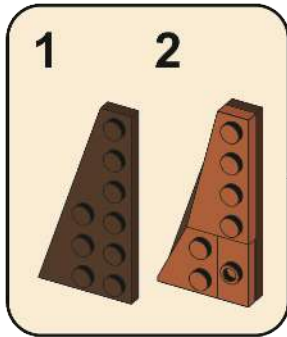

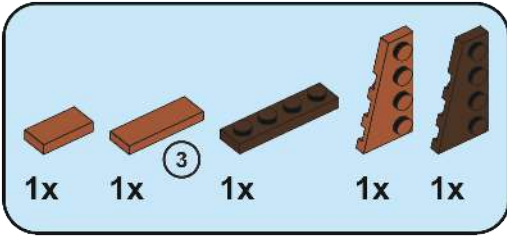

79

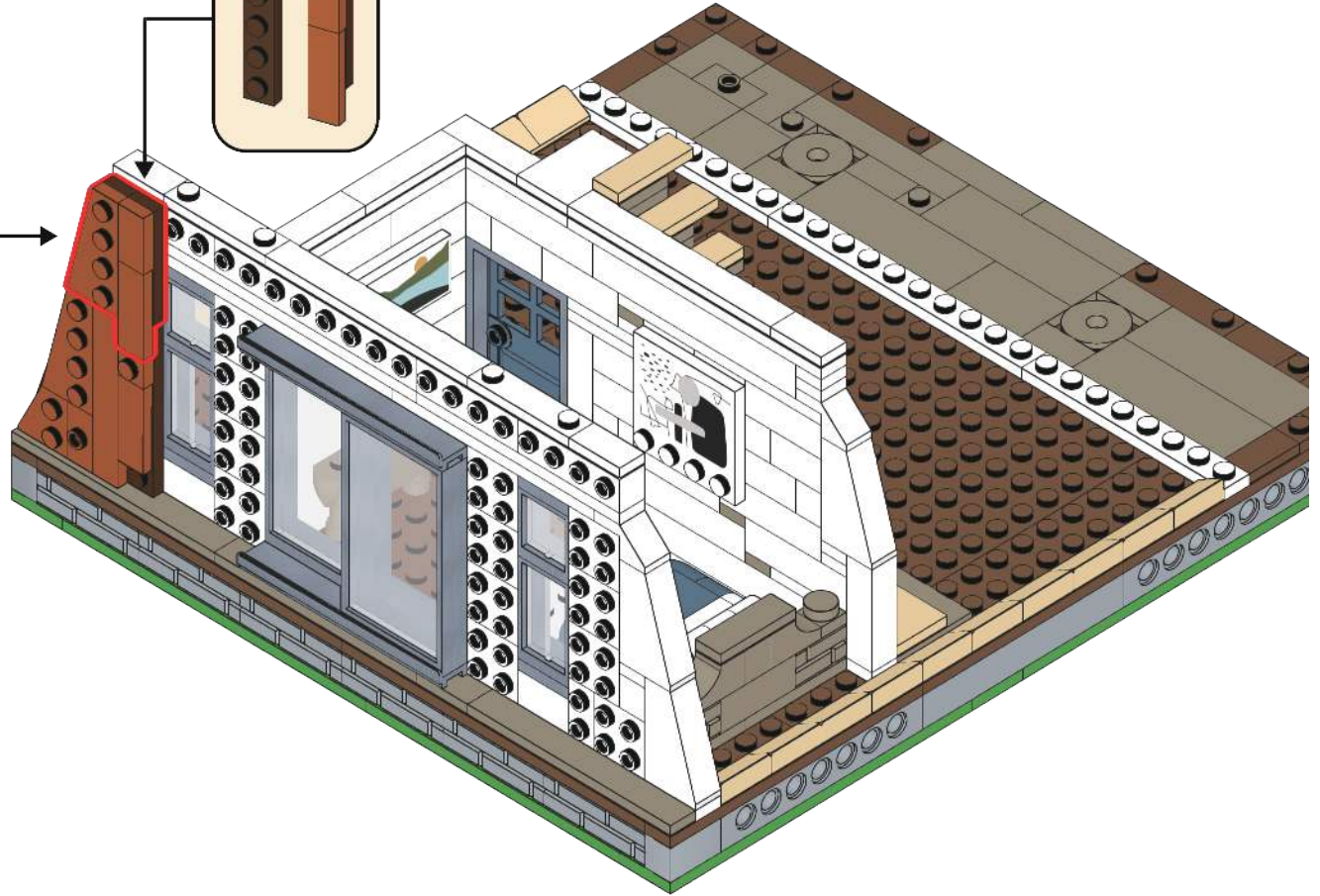
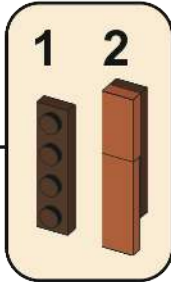
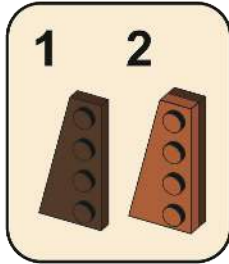

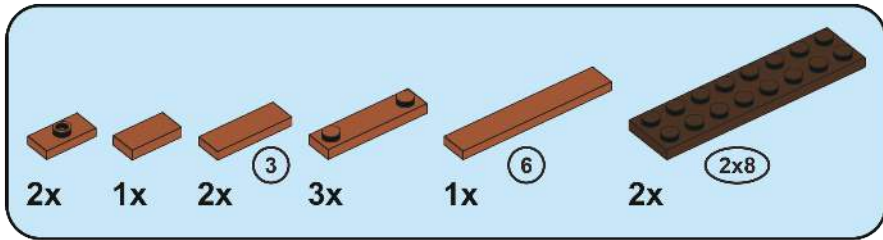

80

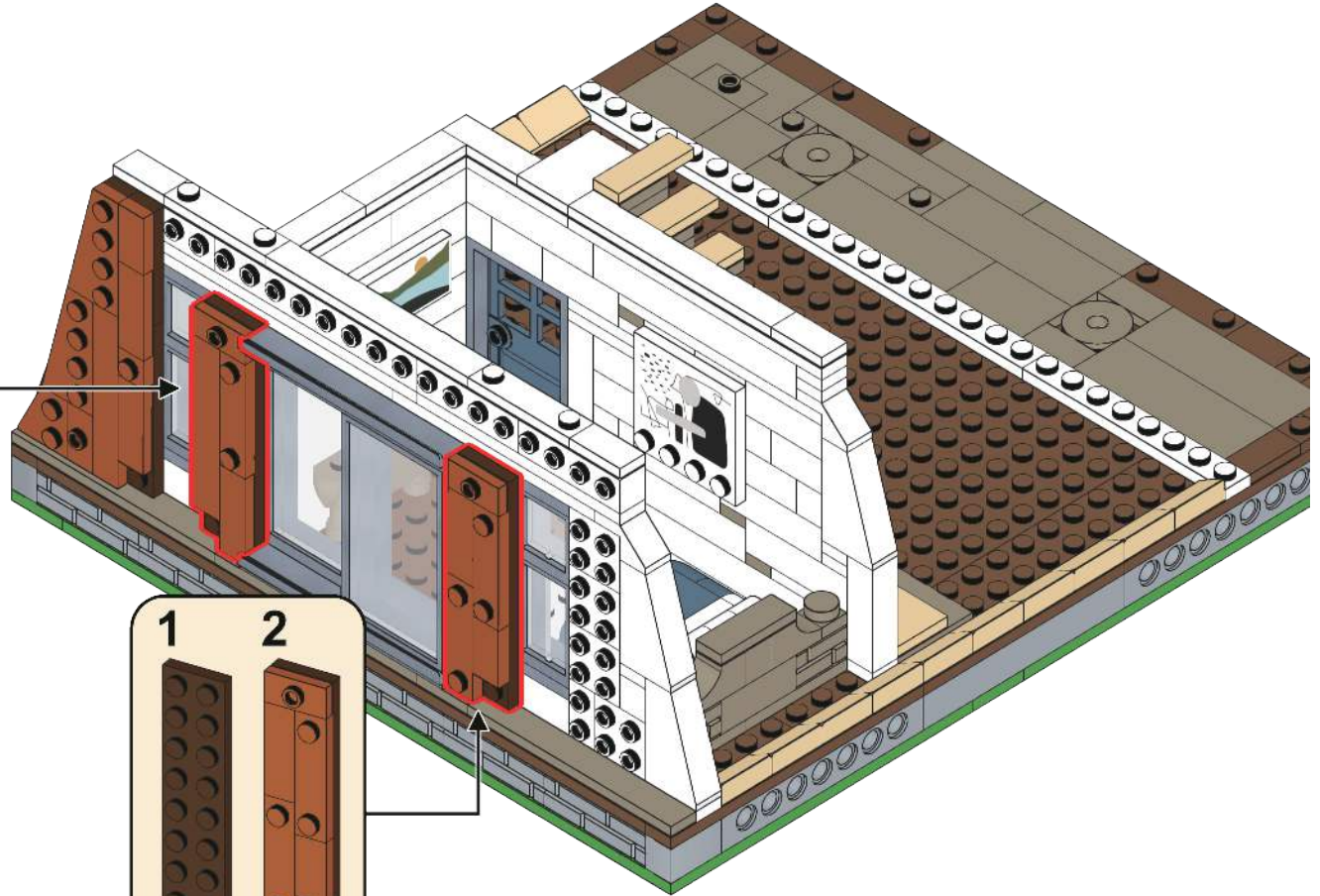
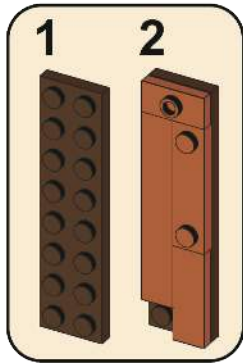

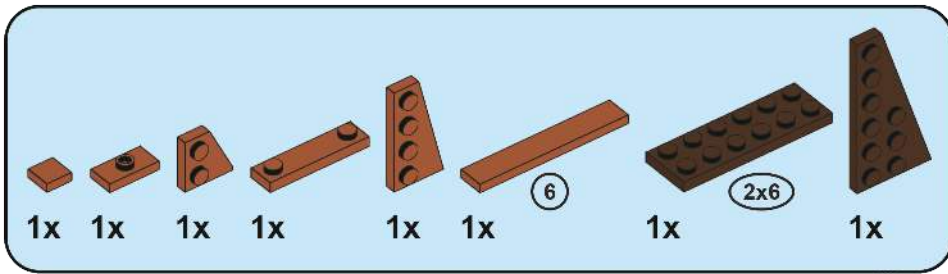

81

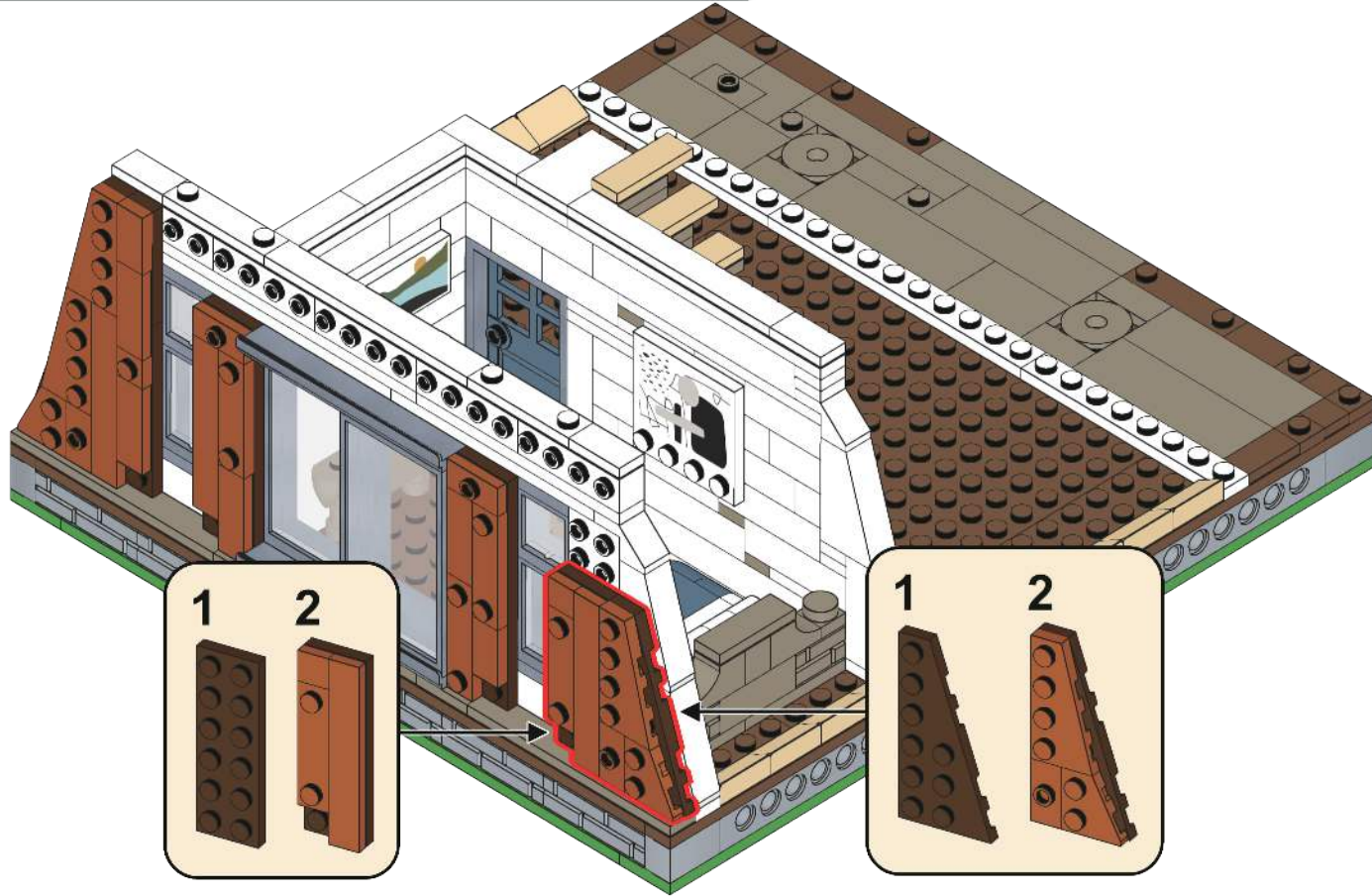

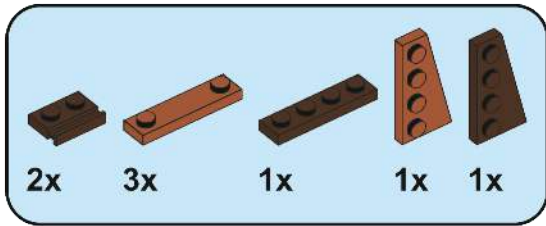

82

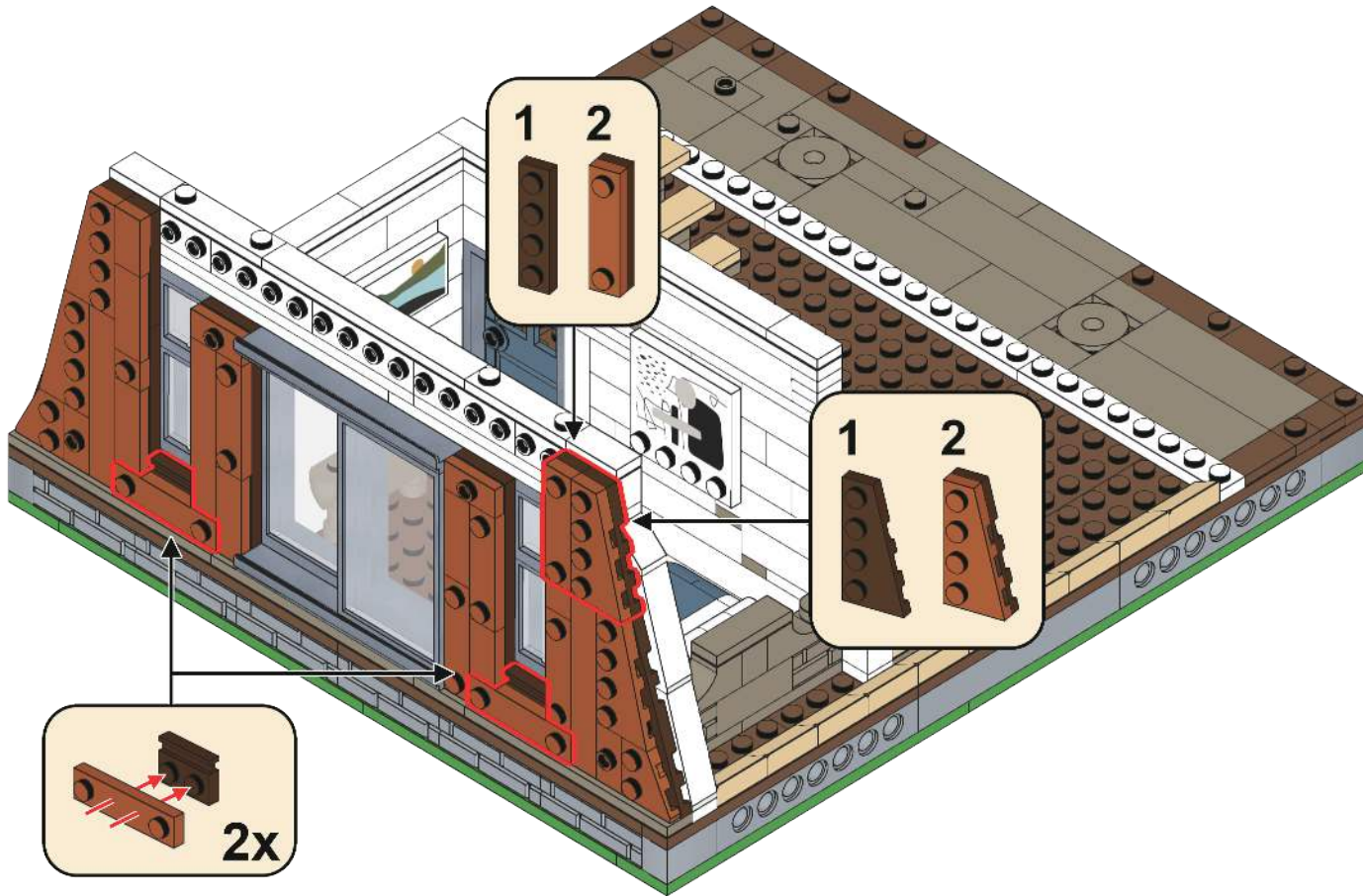

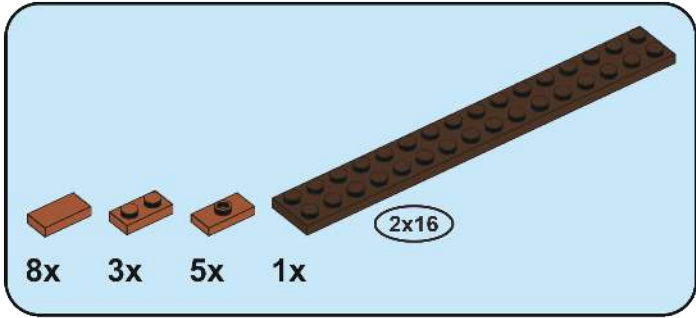

83

