

495

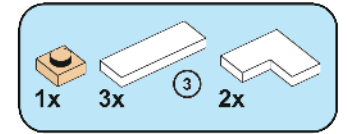

496

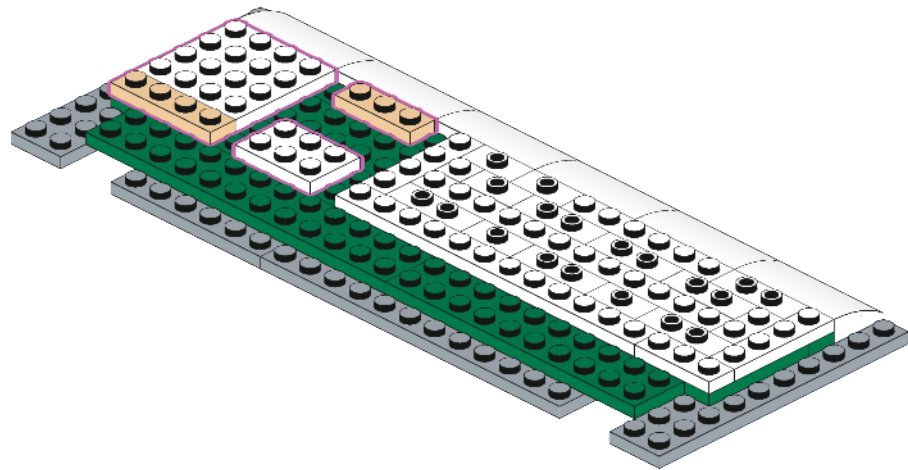

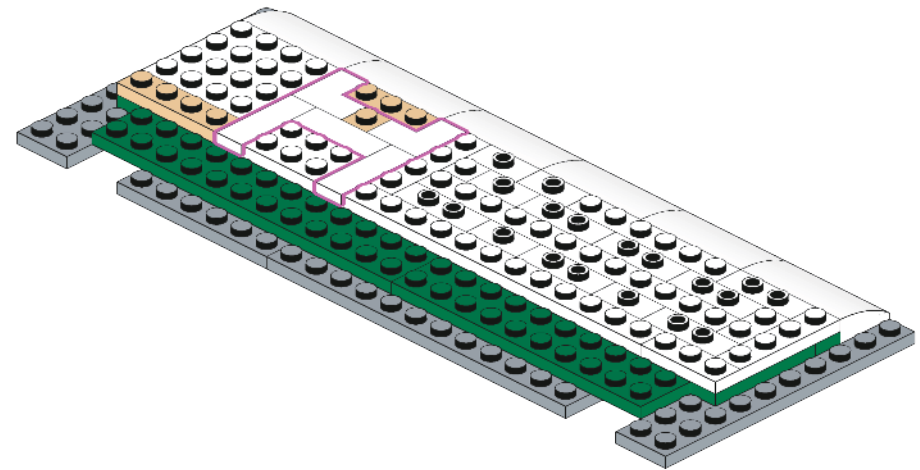
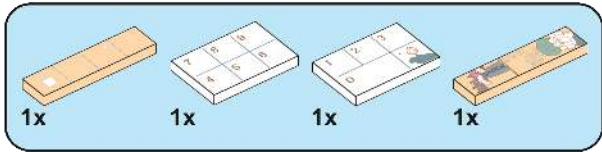

497

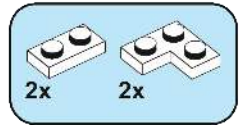
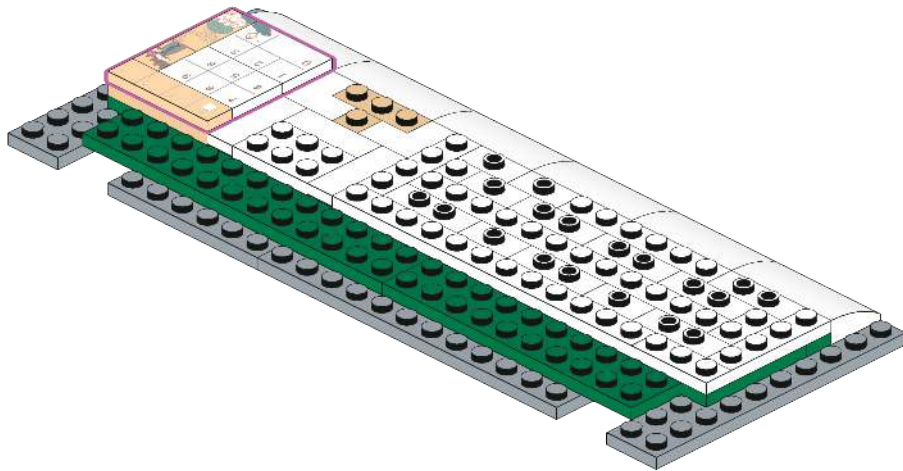

498

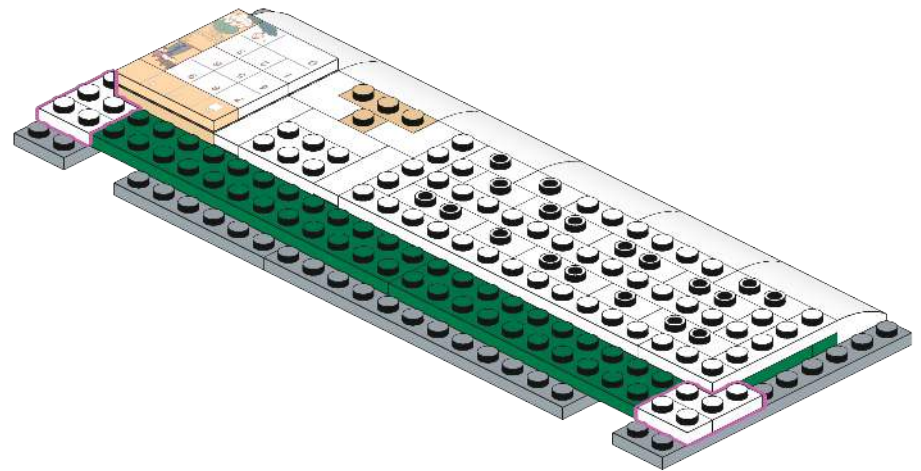

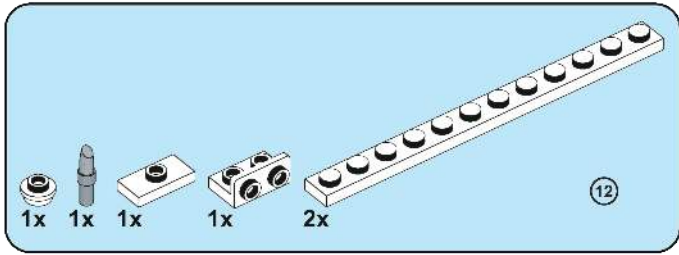

499

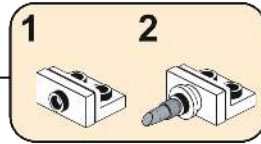

2

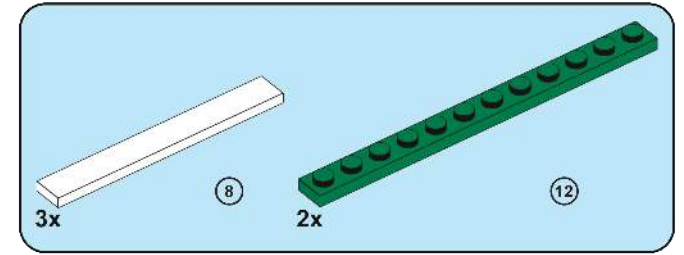
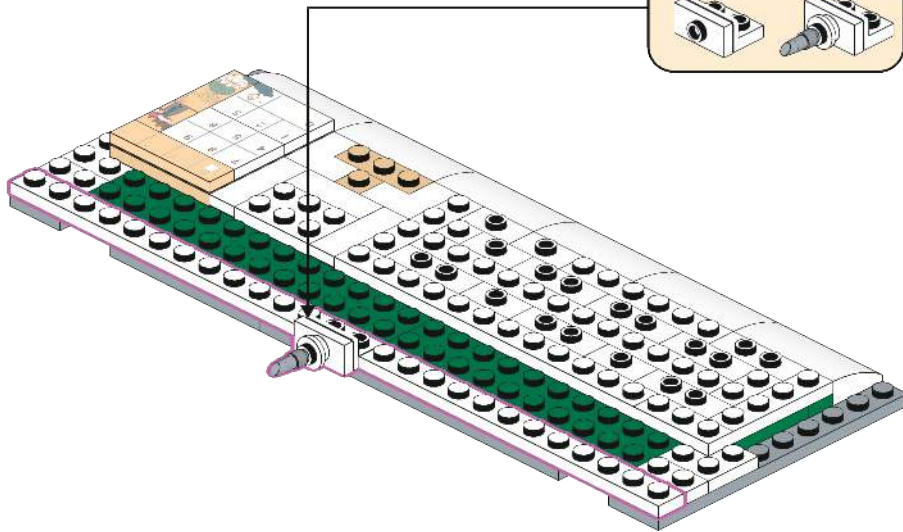

500

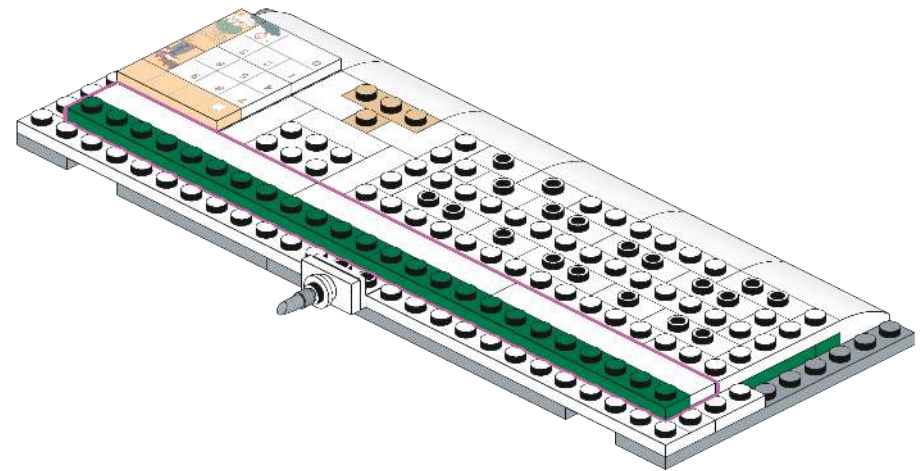

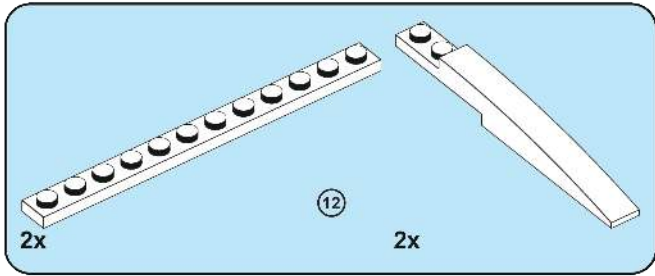

501

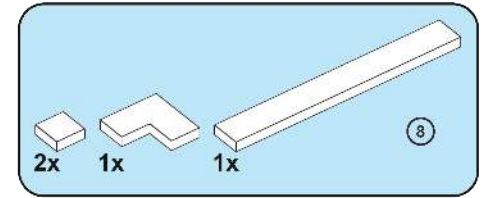
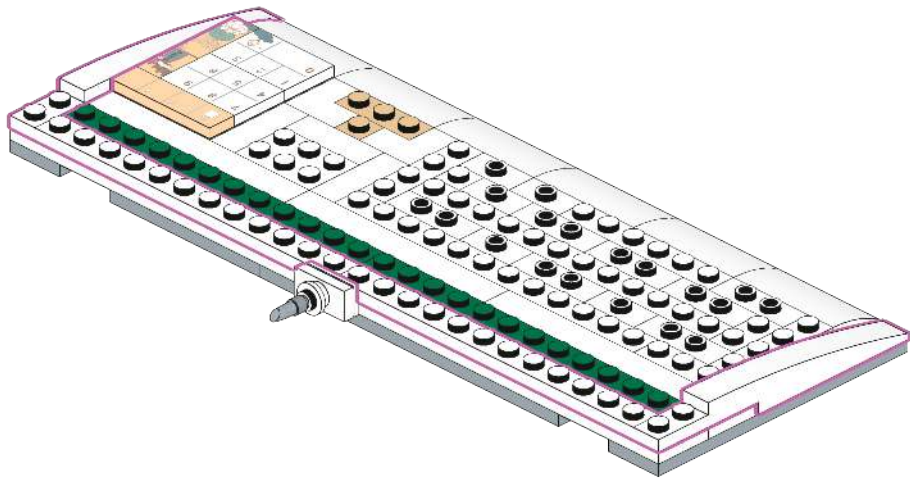

502

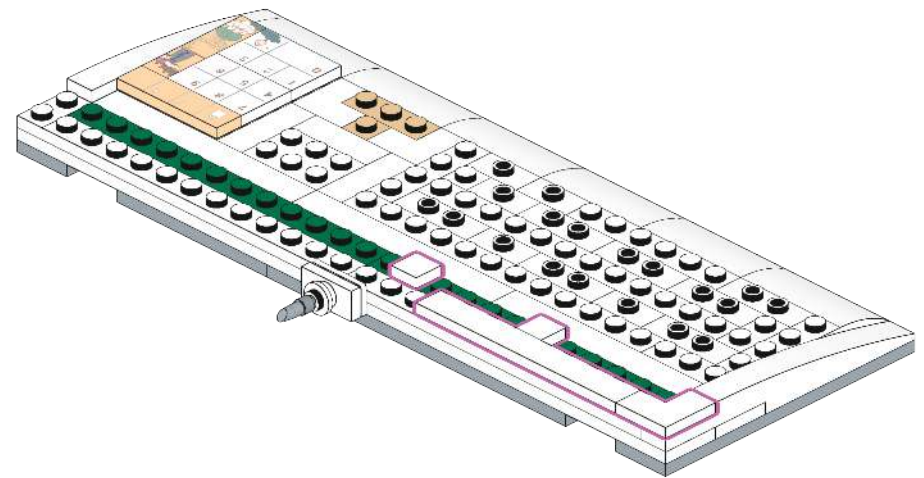

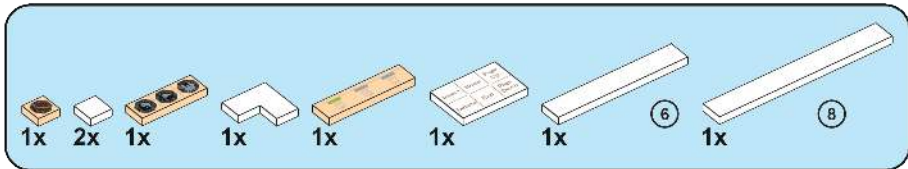

503

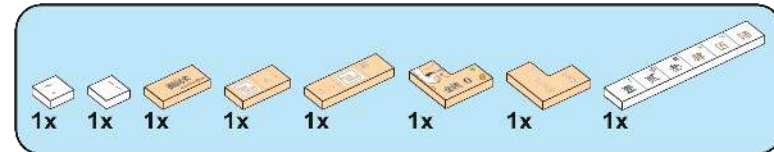
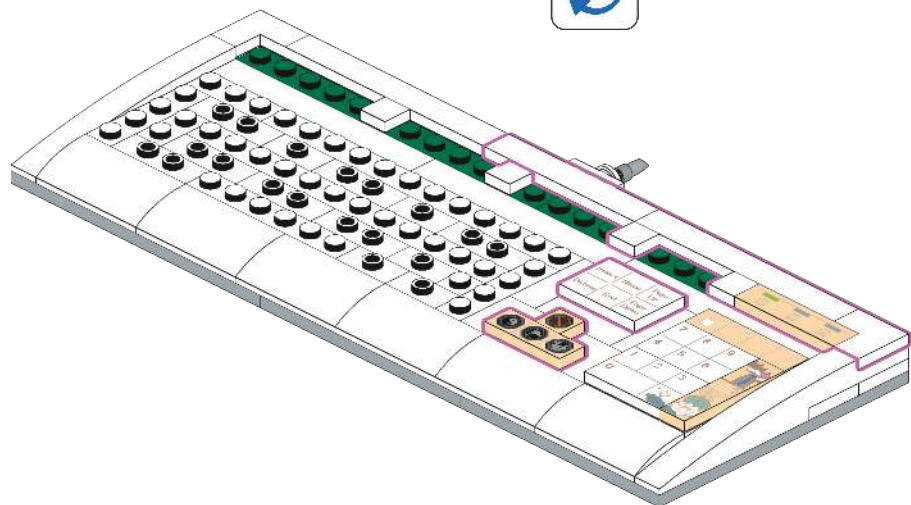

504

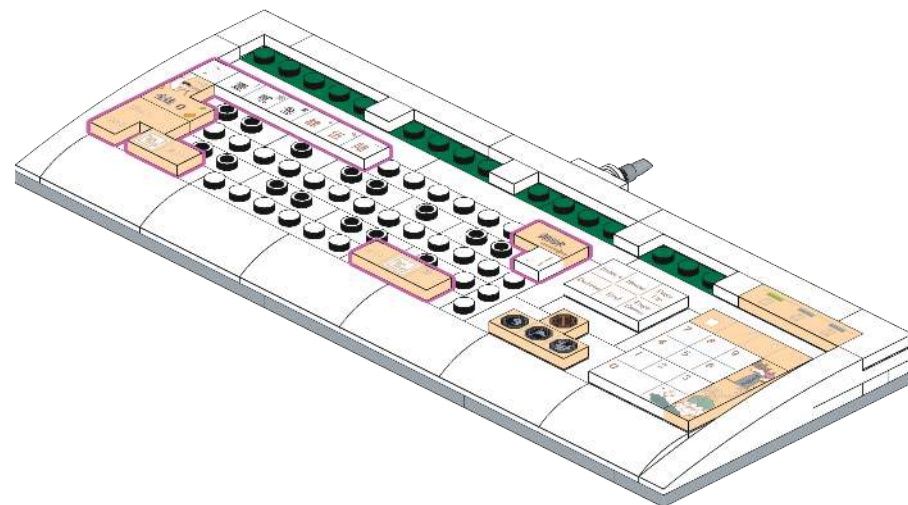

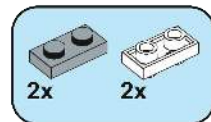
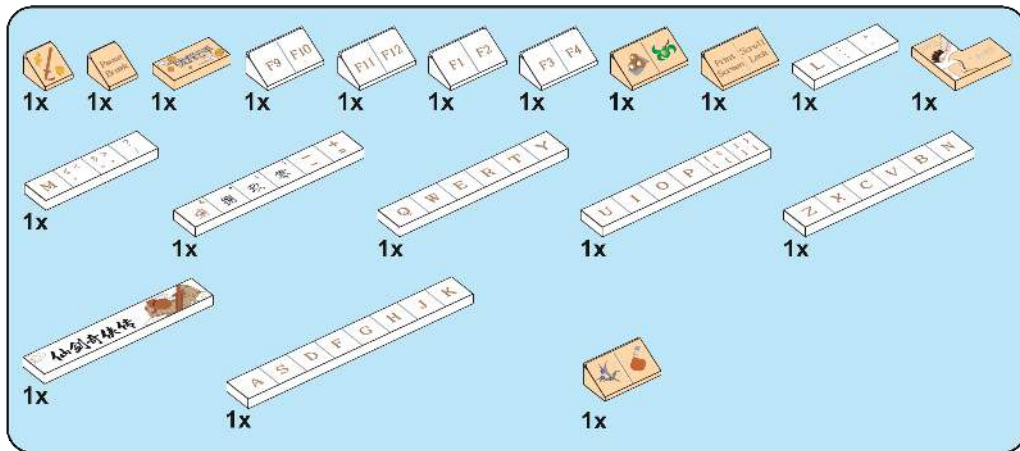

506

505

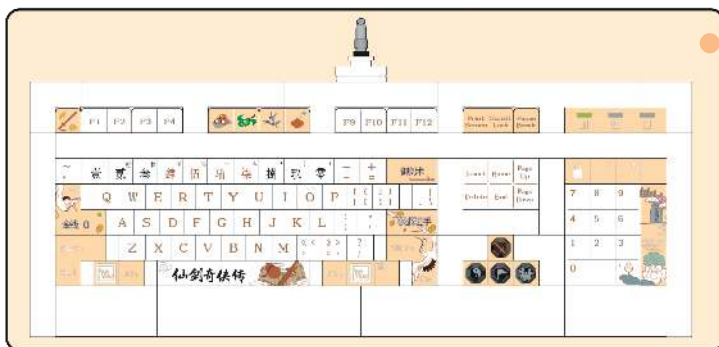
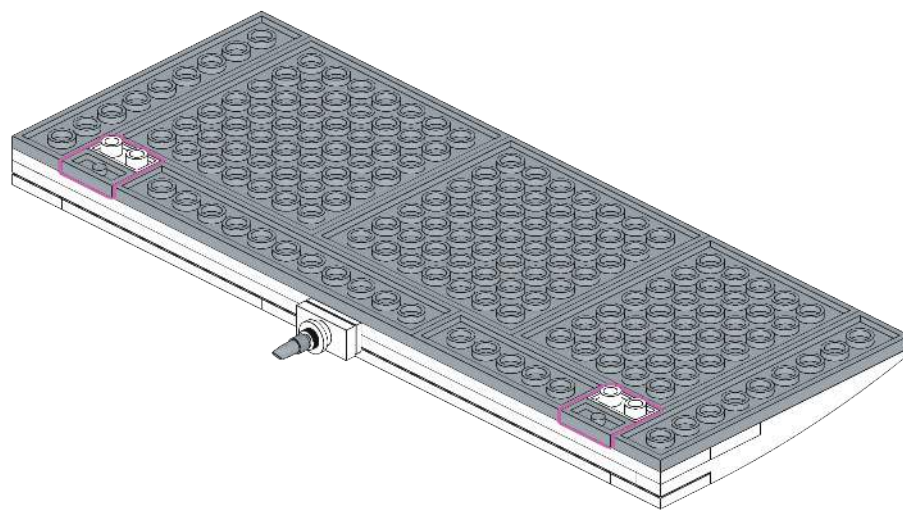
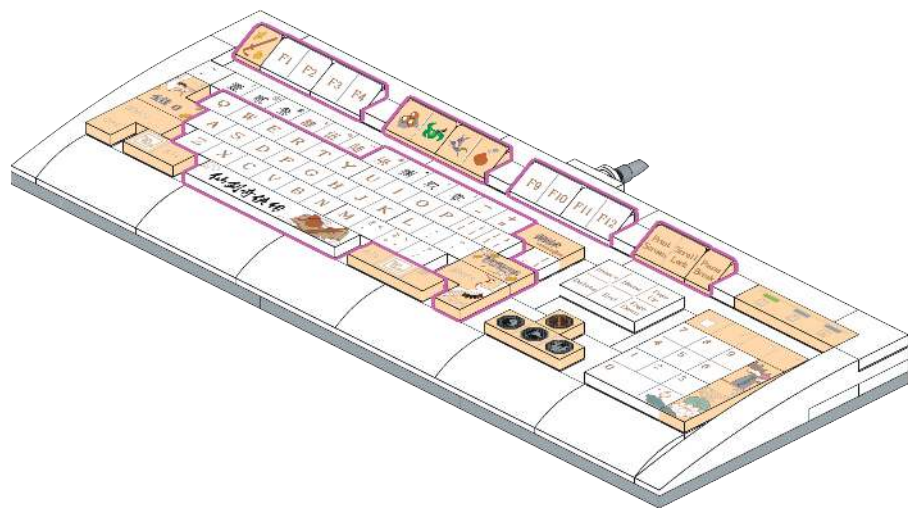

可根据图示核对键位是否拼搭有误。



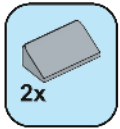

507

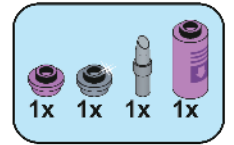
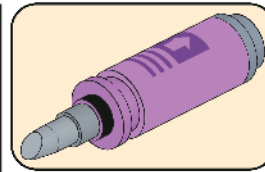
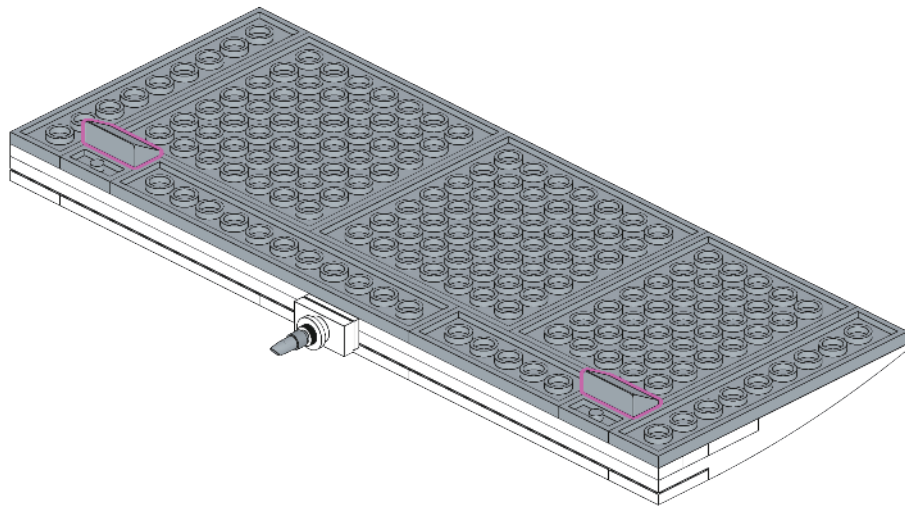

508



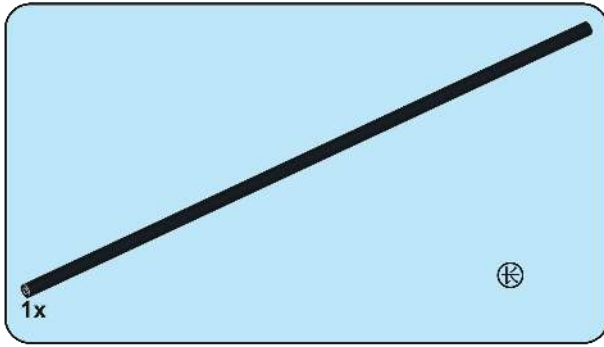

509

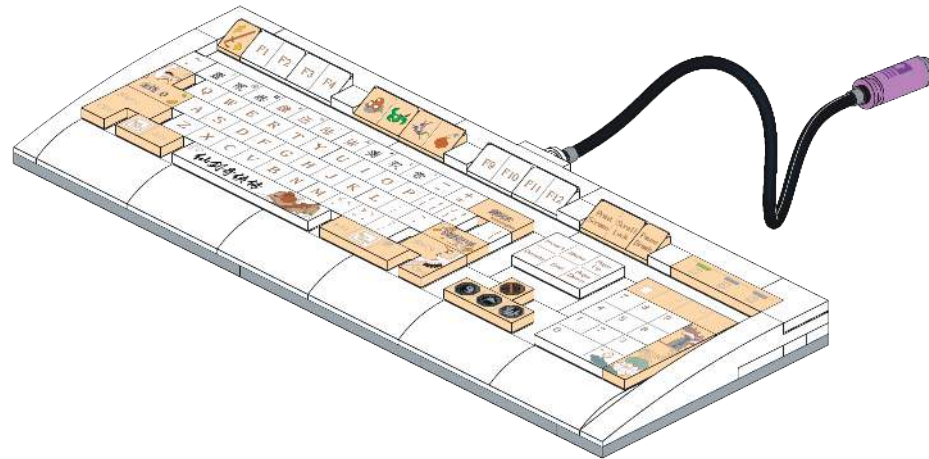
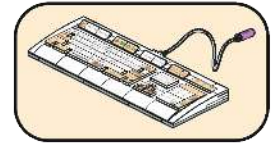

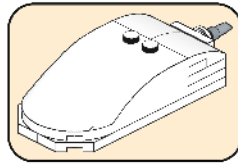
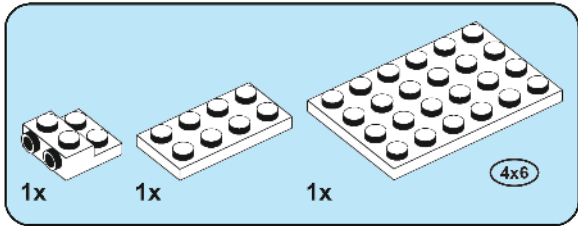

510

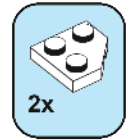
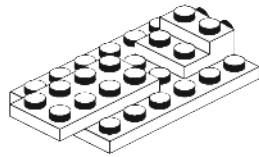

511

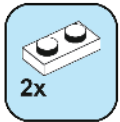
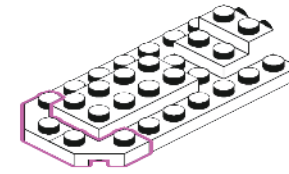

512

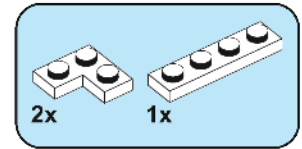
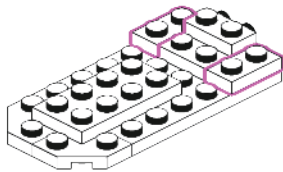

513

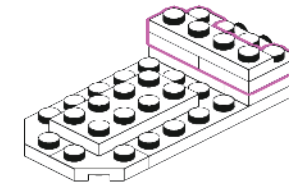

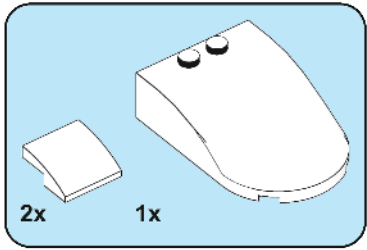

514

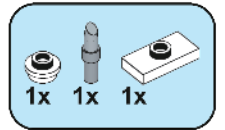
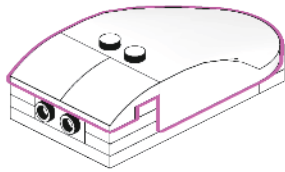

515

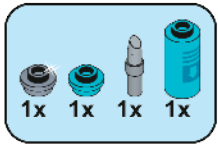
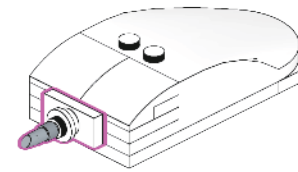

516

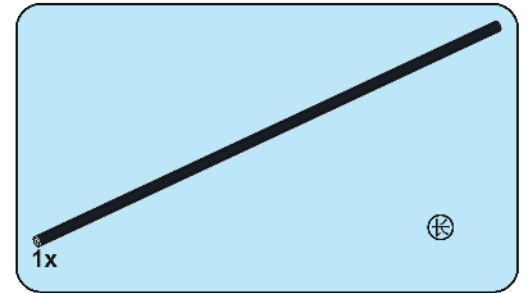
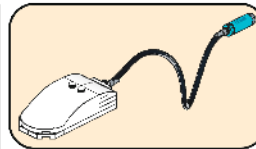
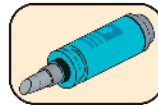

517

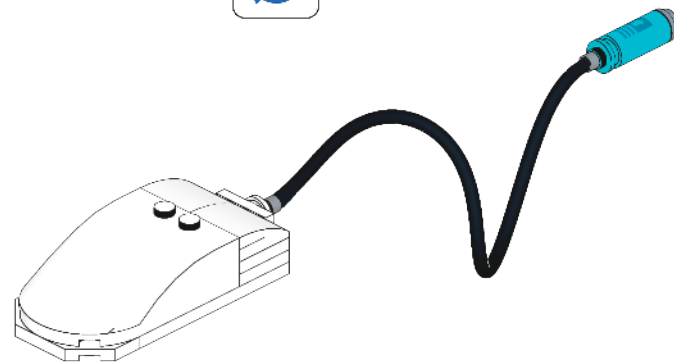

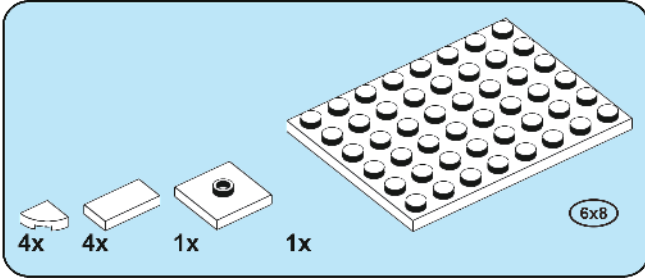
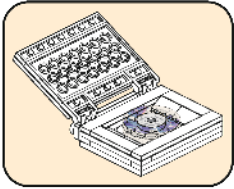

518

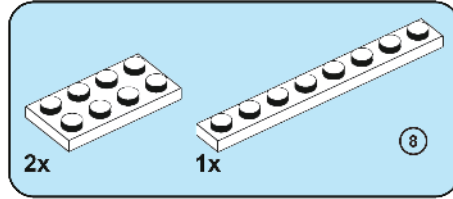
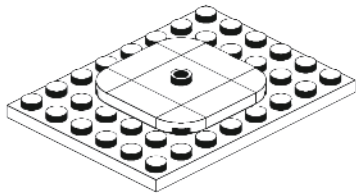

519

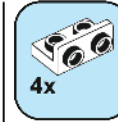
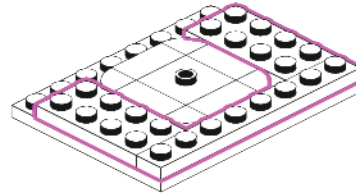

520

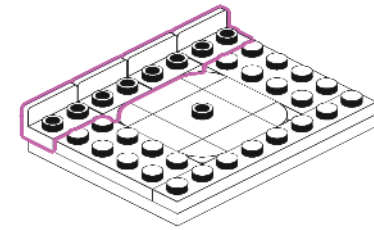

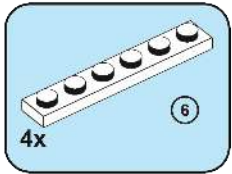

521

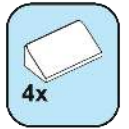
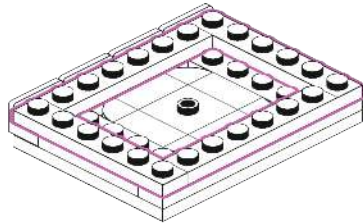

522

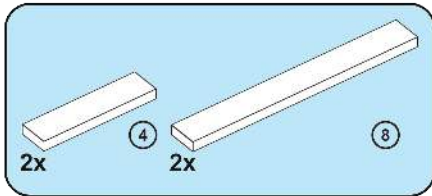
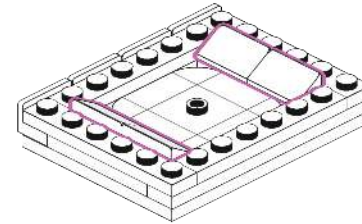

523

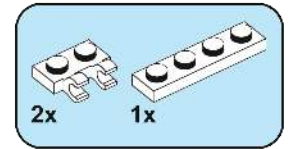
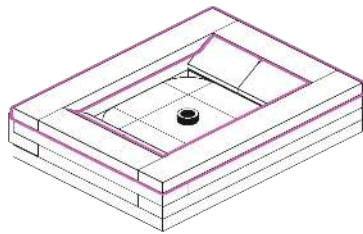

524

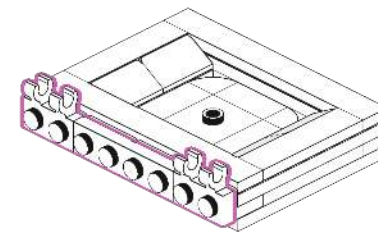

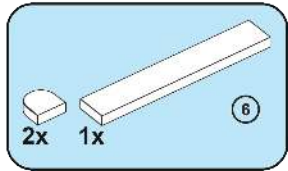

525

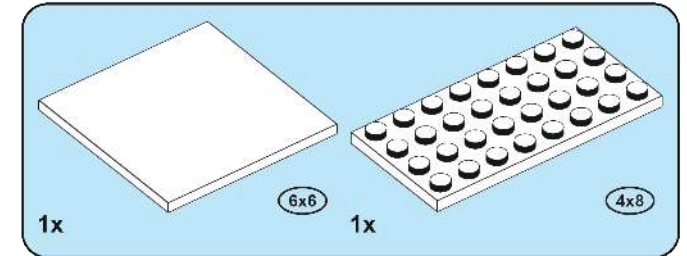
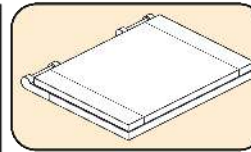
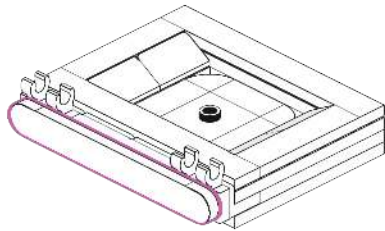

526

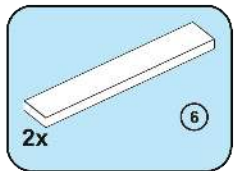
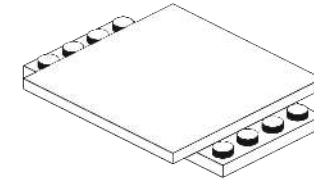

527

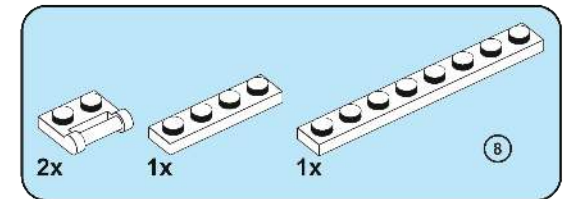
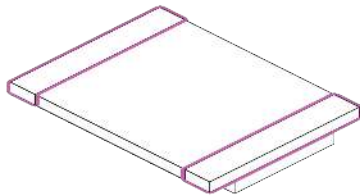

528

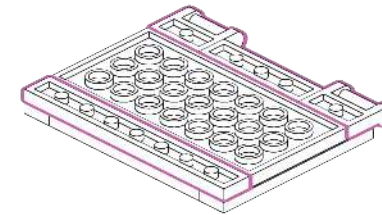

529

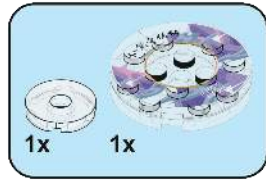
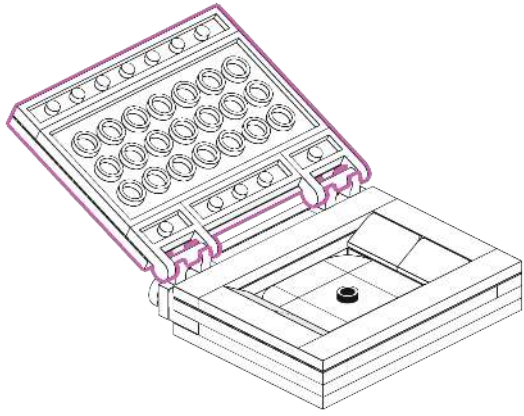

530

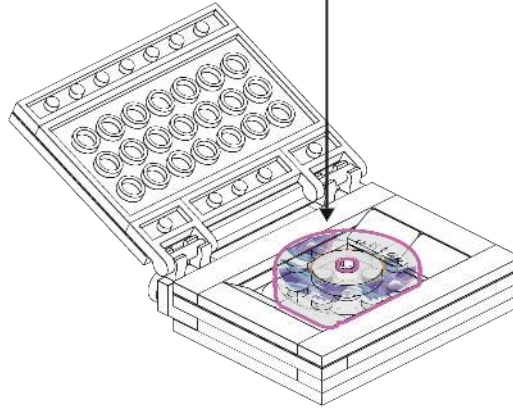
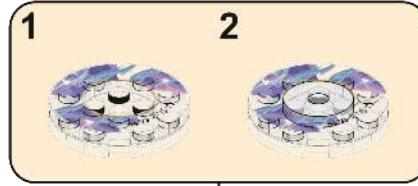

531

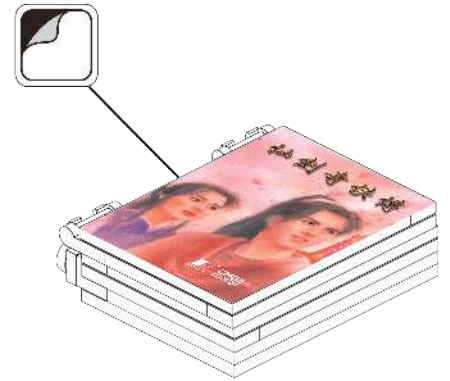

532

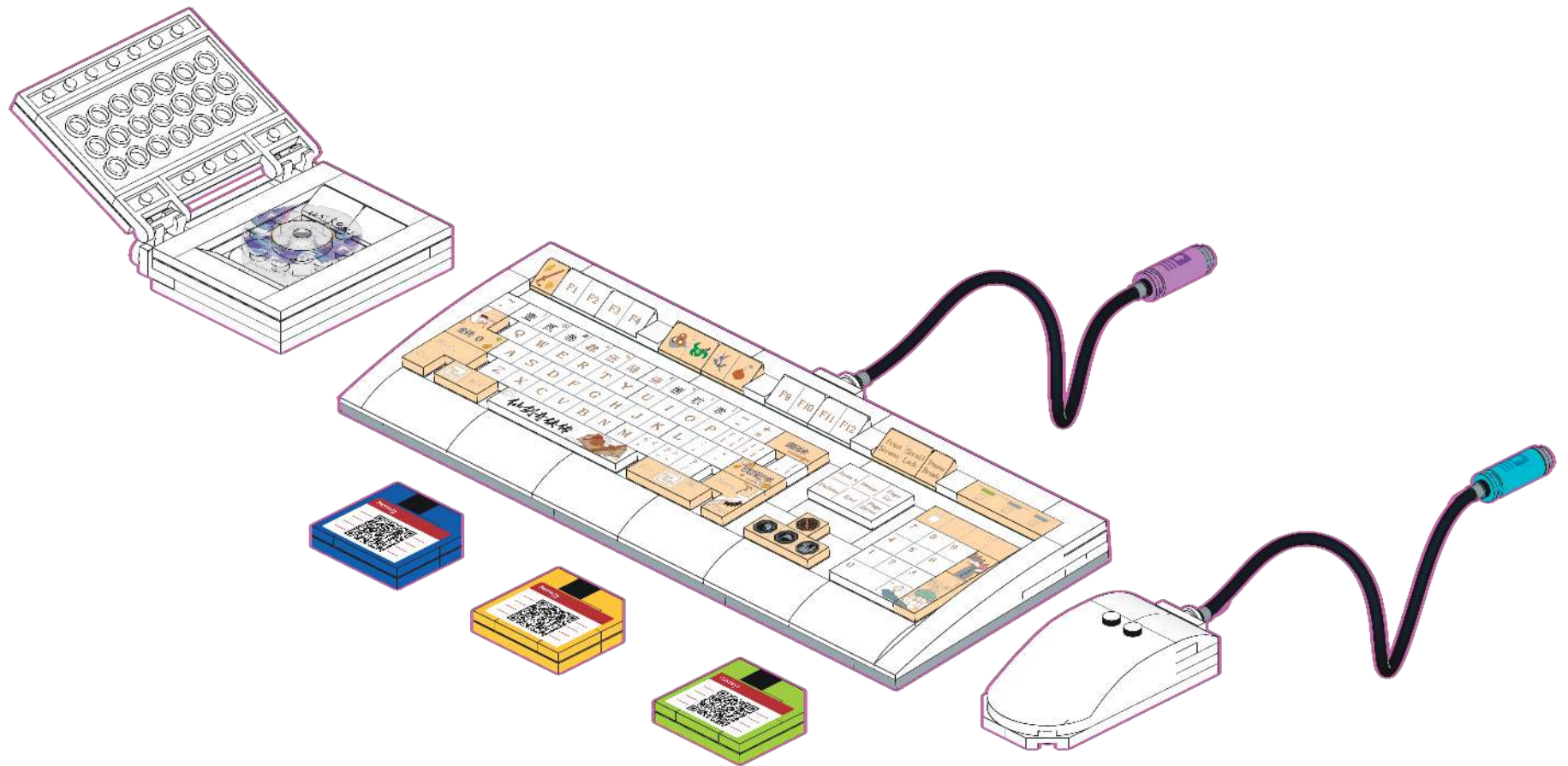

533

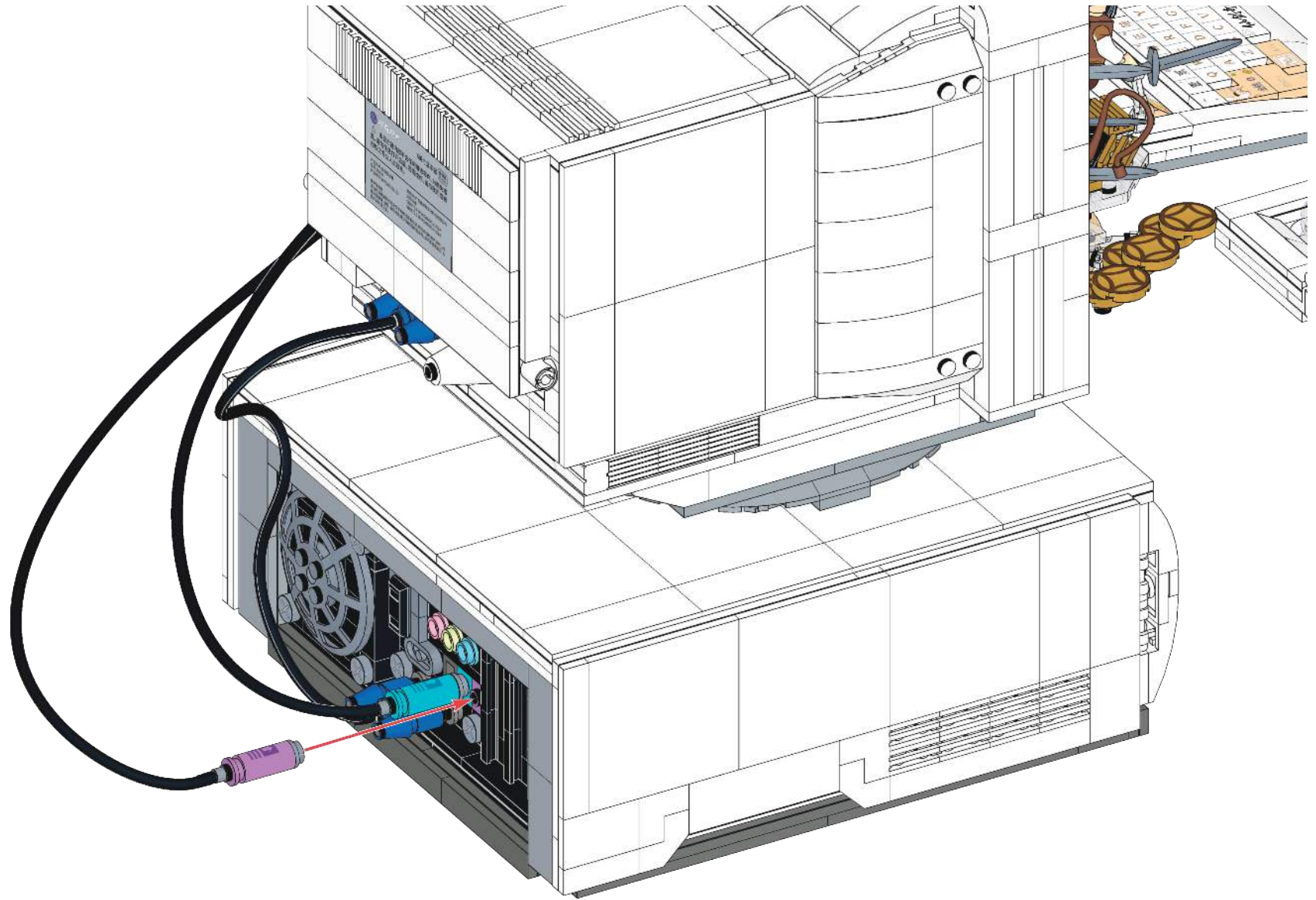

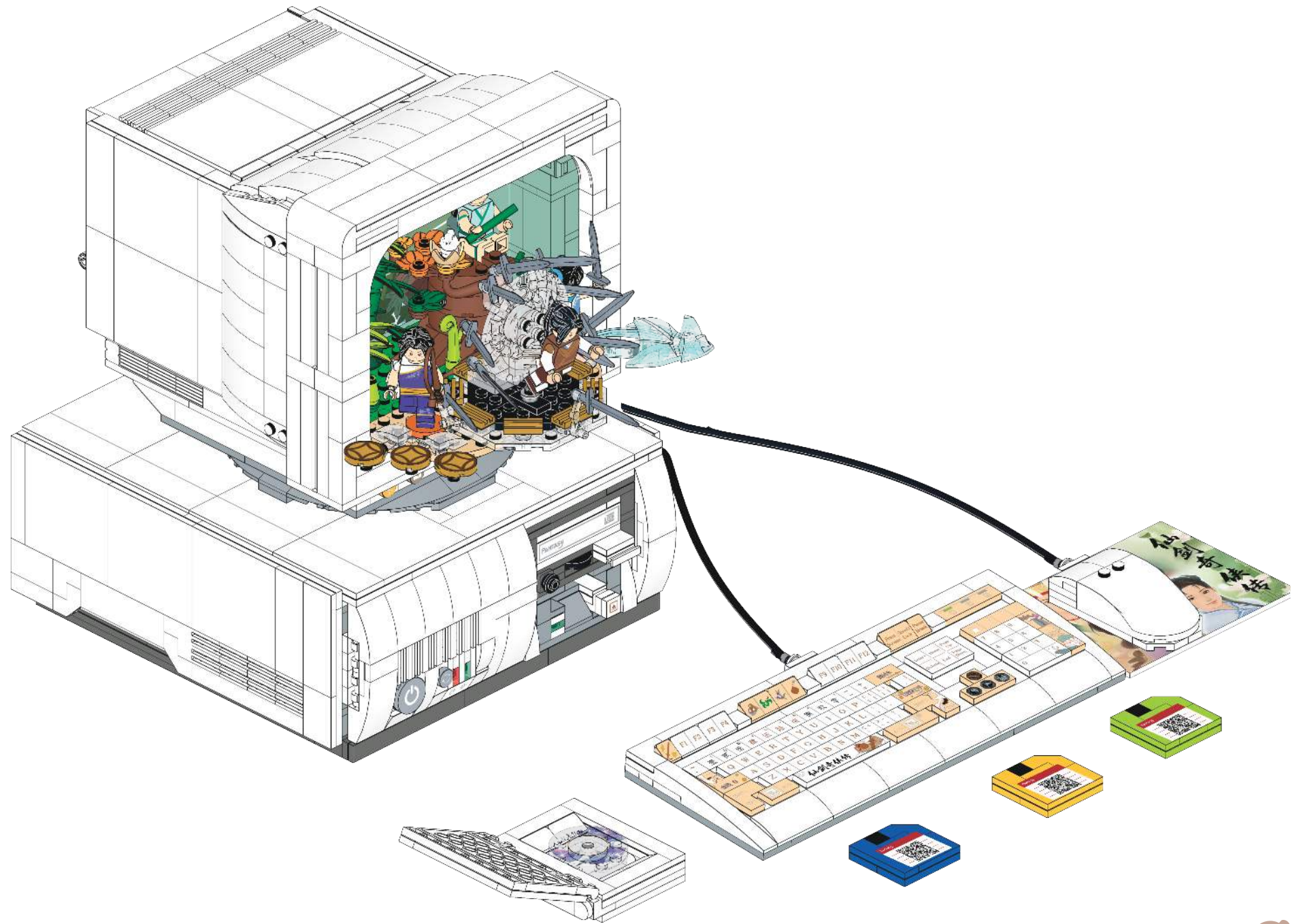

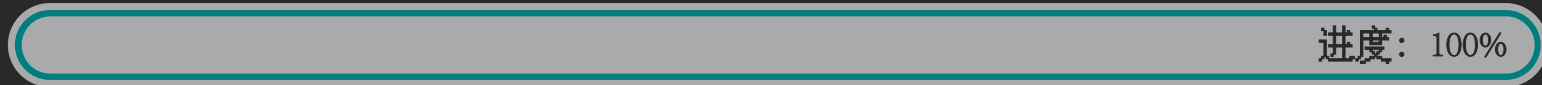



开课啦
玩法小课堂

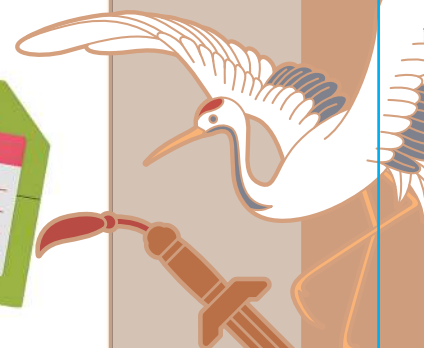

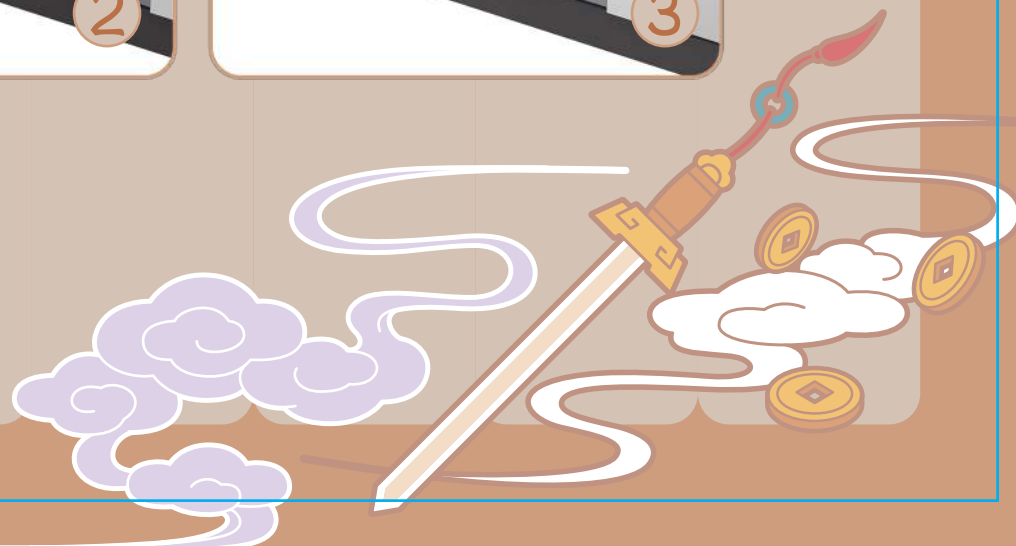

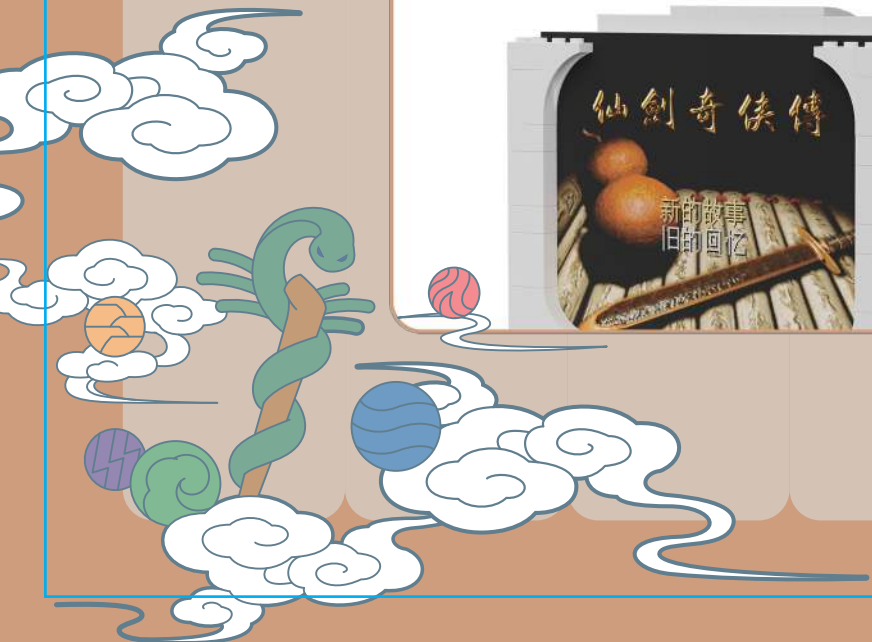

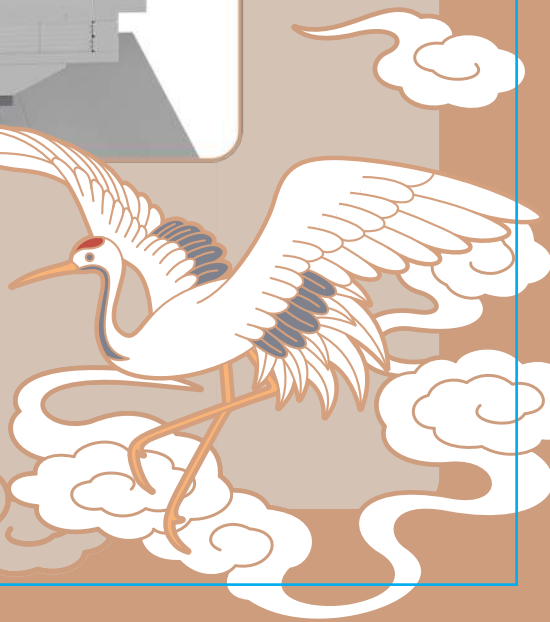
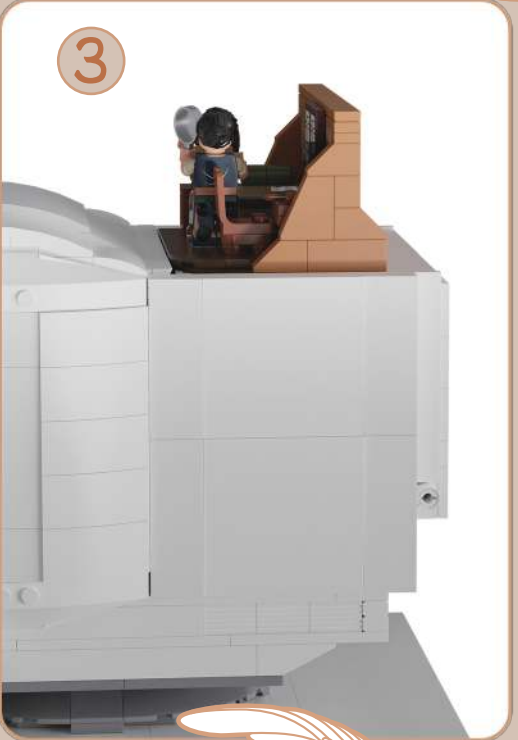
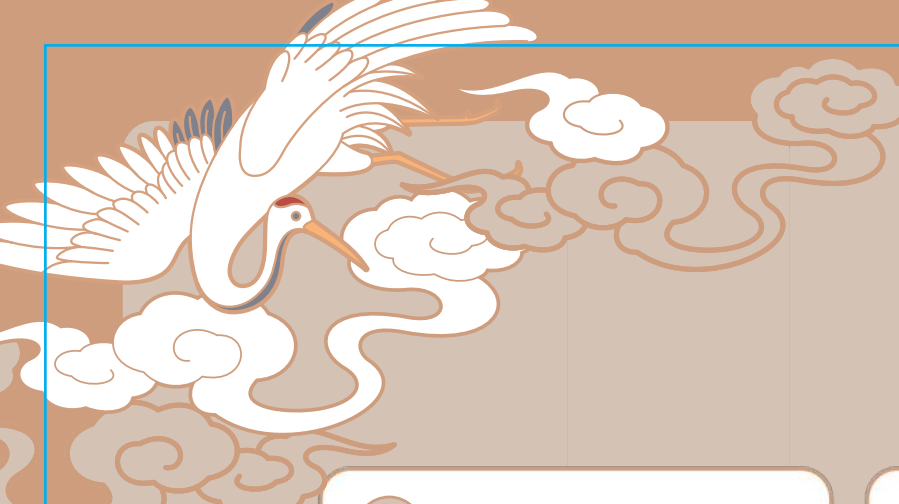



鉄腕アトム ASTRO BOY

拼奇积木

86203

铁臂阿童木
透视机甲

86205

铁臂阿童木
觉醒时刻

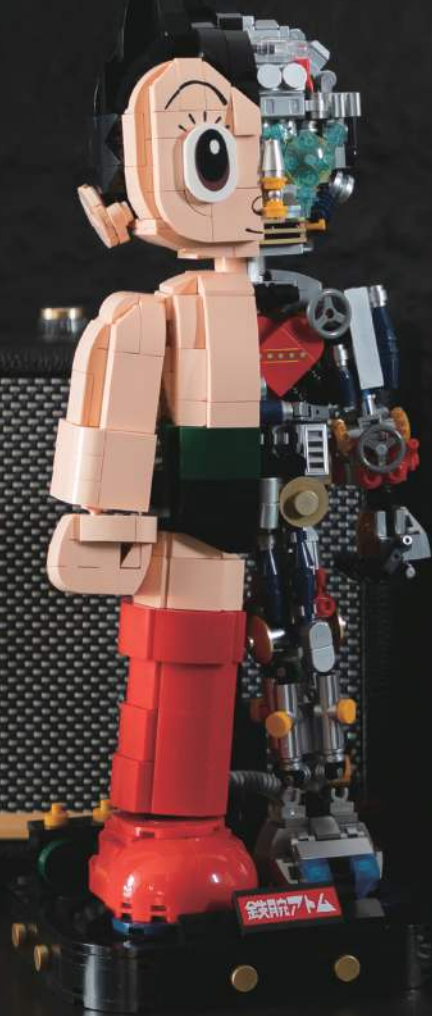



拼奇积木

86601

黄金射手座星矢





武林外传
My own swordsman

拼奇积木

86220

同福客栈场景





拼奇积木

86231

合金弹头3场景
NEOGEO街机积木





拼奇积木

61008

复古电视机

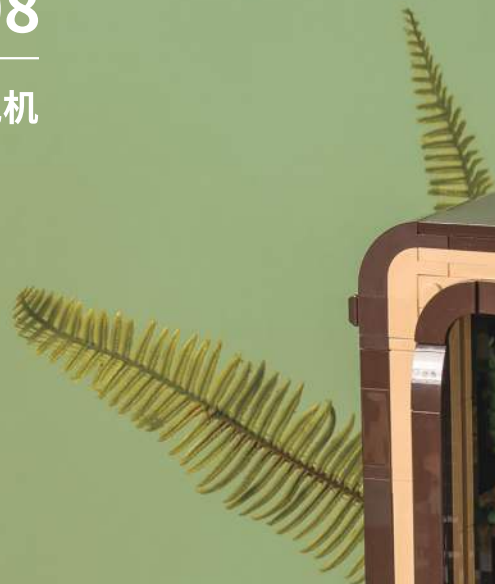



拼奇积木

86218

福尔摩斯
贝克街221B



Arthur Conan Doyle

THE
CONAN DOYLE ESTATE



礼



←
·积分兑换
·官方补件

扫码关注
官方公众号
解锁「多重福利」

* 好礼不定时更新, 具体以拼奇官方会员中心公告为准。



笔笔消费换积分,
限定好礼等你兑~

颗粒走丢?
官方补件售后免排队!

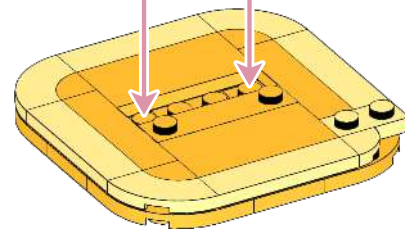



拼奇积木