



拼奇积木

99101

福尔摩斯与华生

正版授权

Conan Doyle Estate Limited
柯南道尔遗产基金会





拼奇积木

为收藏而生



呈现 成年人
记忆深处的情结，
打造东方审美的积木，
让收藏可以更有趣。

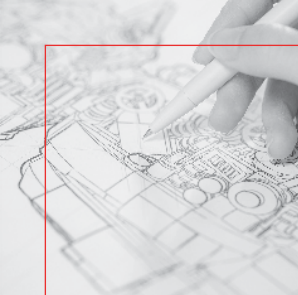

▼ 每一个面世的作品, 都战胜了无数个孪生兄弟

▲ 将现实抽象创作, 再重塑现实本身

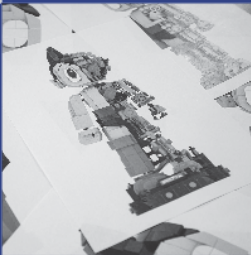

▼ 积累每一次突破, 直到真正的颠覆

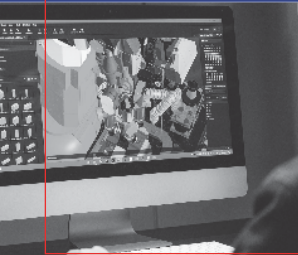
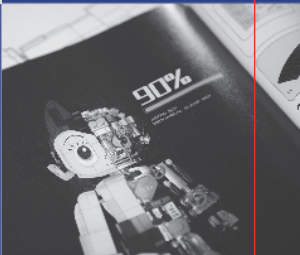

◀ 再不起眼的角落, 也经历多轮打磨



扫码添加
拼奇官方福利官

- 会员计划
- 专属礼品
- 新品共创



Sherlock Holmes

夏洛克·福尔摩斯

简介:

福尔摩斯探案集的主角，一名才华横溢的侦探，柯南·道尔曾如此描述这位大侦探：瘦高个，穿着衬衫，素色，搭配深色马甲（背心）和配套夹克。

喜欢吸烟斗，戴猎鹿帽，拉小提琴，听音乐会，会把来信用一把折刀插在木制壁炉的正中央。

基于书中的描绘，我们为福尔摩斯的人仔绘制了西装马甲，翻领长风衣，配备了猎鹿帽，手持放大镜，以还原福尔摩斯最经典的形象。



Dr. Watson

华生医生

简介:

华生是侦探的得力助手，包括了做诱饵、助手和信使。不仅如此，他还是福尔摩斯的记录人。

故事的绝大部分是从华生的视角来叙述的，是侦探精彩活动的总结。

华生曾经在战场上负伤，我们为仔配备了一只手杖作为他的手持配件。



这么拼更快噢



1. 按分包序号依次拼搭



2. 拼搭前按颜色或形状分类零件

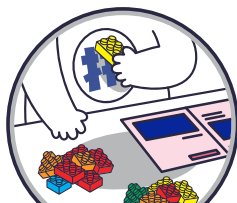

3. 对应图纸根据步骤内零件表分拣

有困难找拼奇奇

1. 零件走丢了?



1. 扫描二维码关注官方公众号
2. 点击下方菜单栏售后客服
3. 添加客服拼奇奇申请补件

2. 拼搭后有零件剩余?

每个套装都会有少量备用零件,拼搭完成后有少量剩余零件无须担心,可储存起来日后使用噢



拼错了?没关系

起件器使用方法

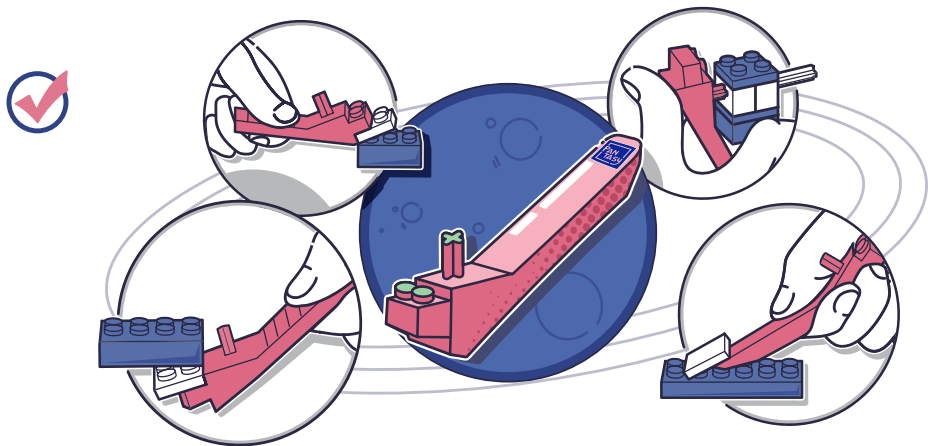

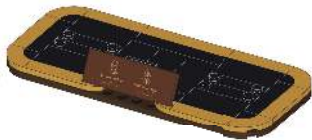
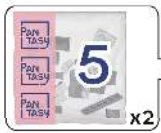
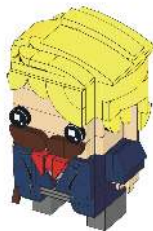
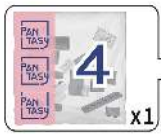
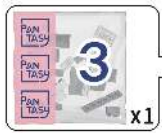
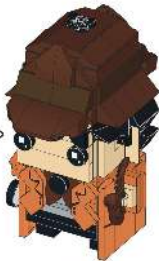
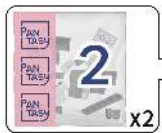
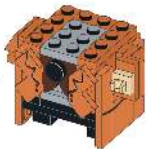
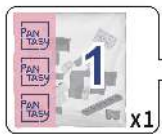

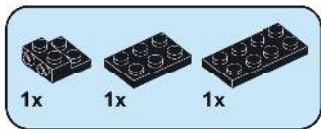
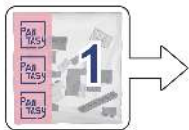

1

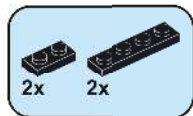
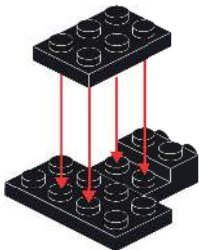

2

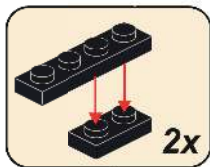



3

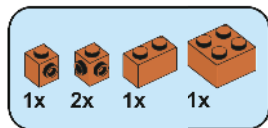
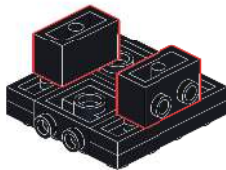

4



2

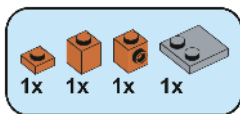

5

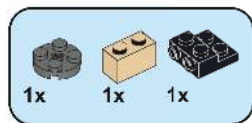
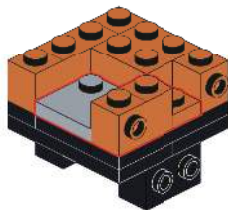

6

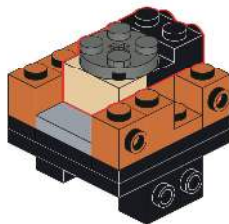

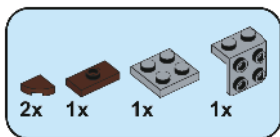

7

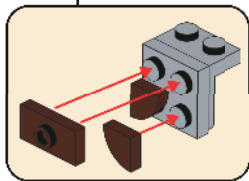
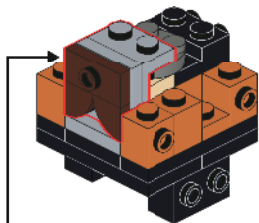

4

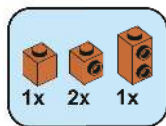

8

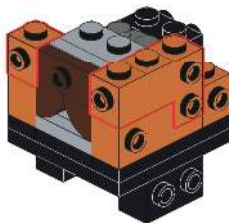

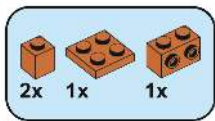

9

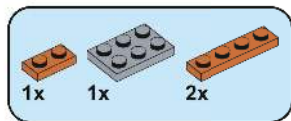

10

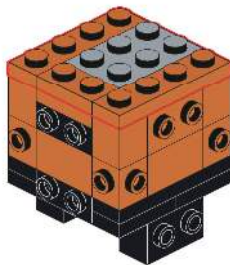

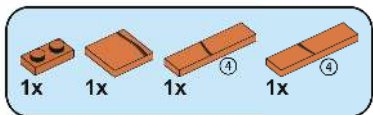

11

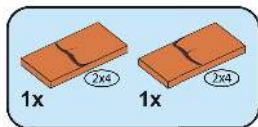
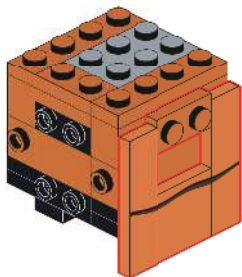

12

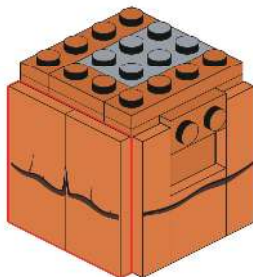

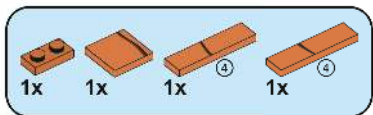

13

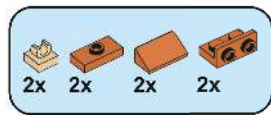
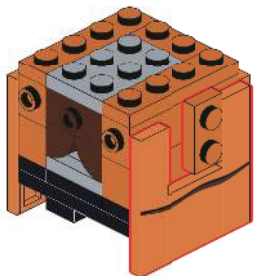

14

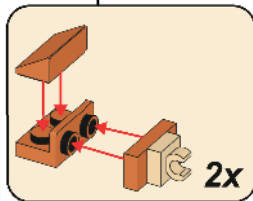
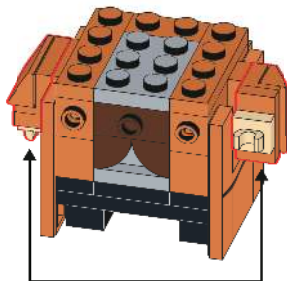

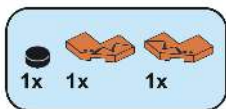

15

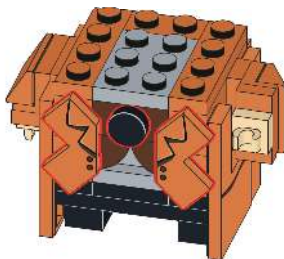

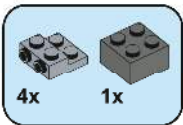
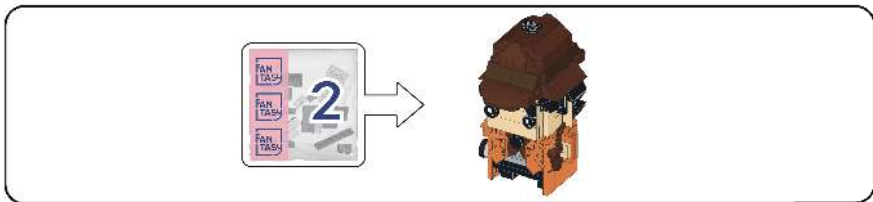

16

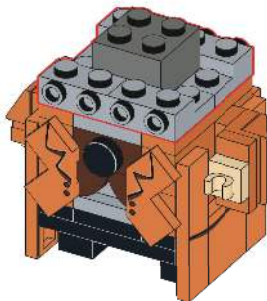

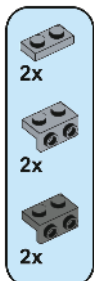

17

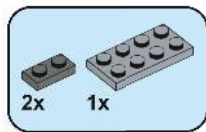
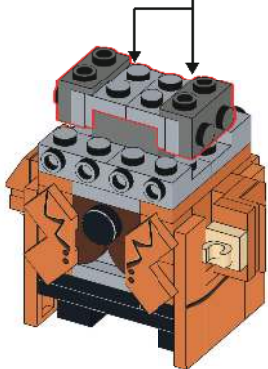
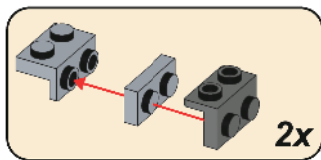

18

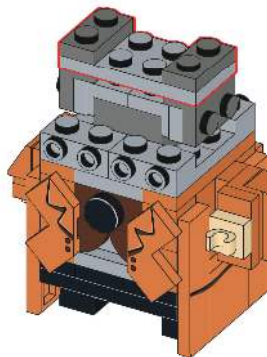

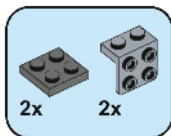

19

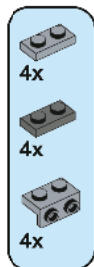
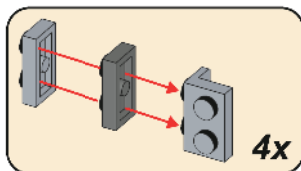
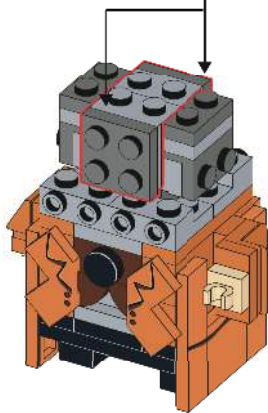
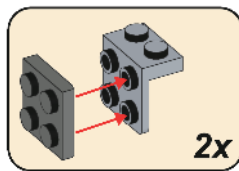

20

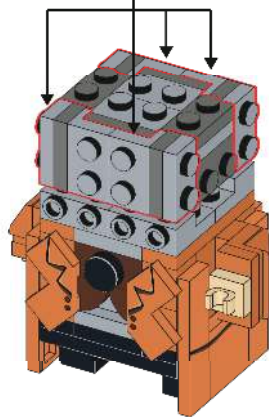

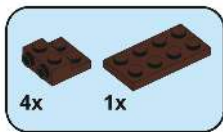

21

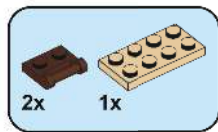
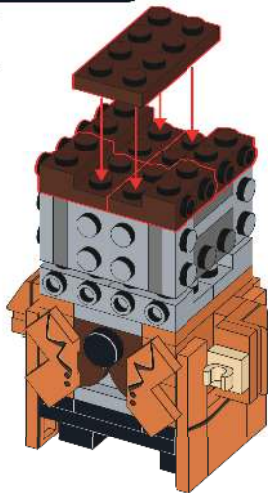

22

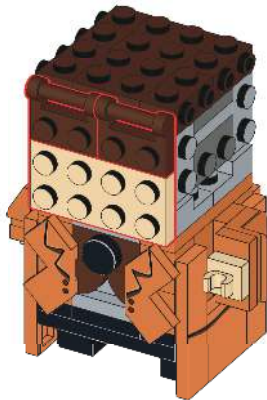

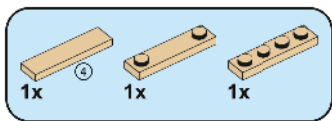

23

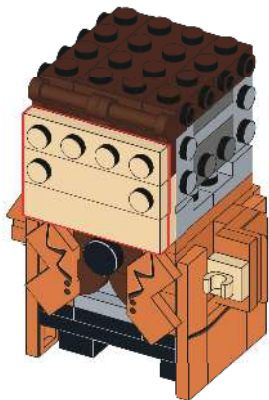

24

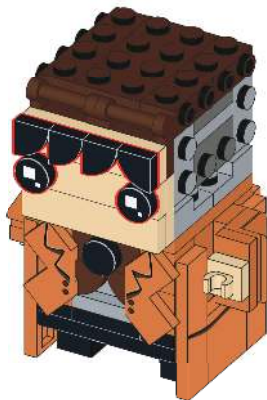

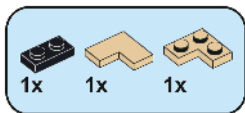

25

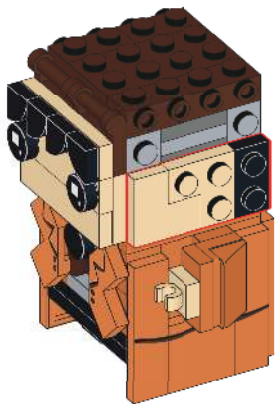

26

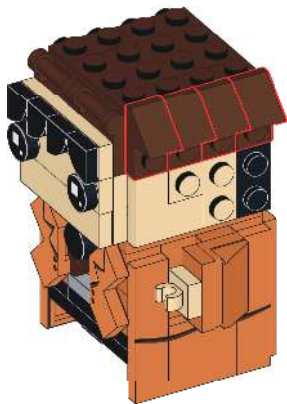

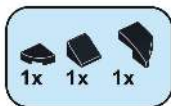

27

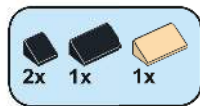
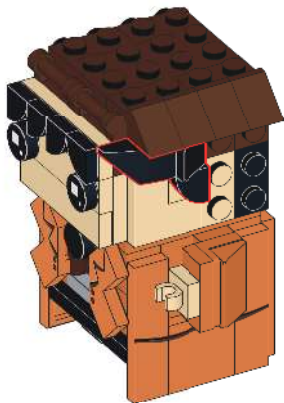

28

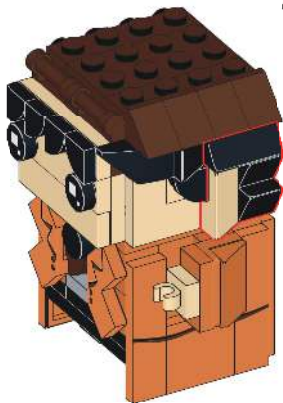

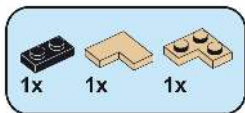

29

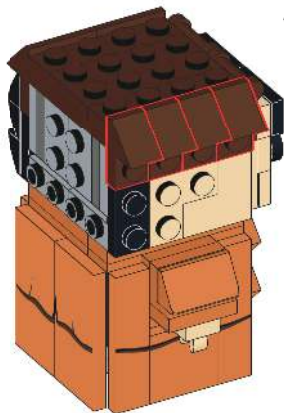
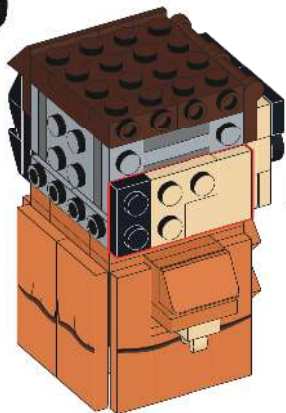

30

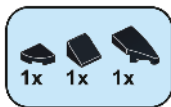

31

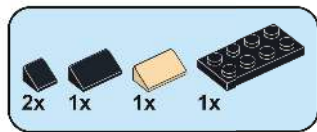
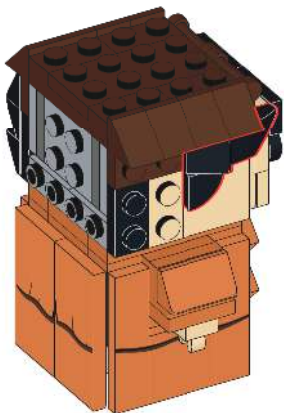

32

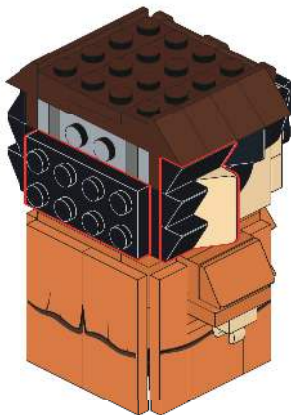



33

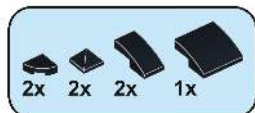
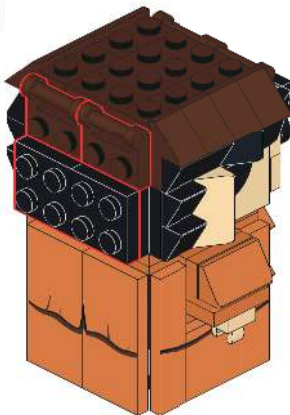

34



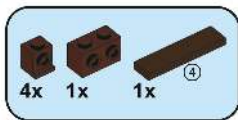

35

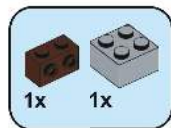
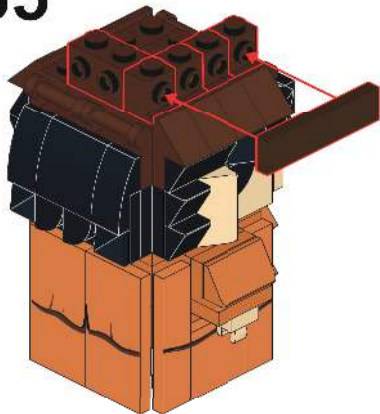

36

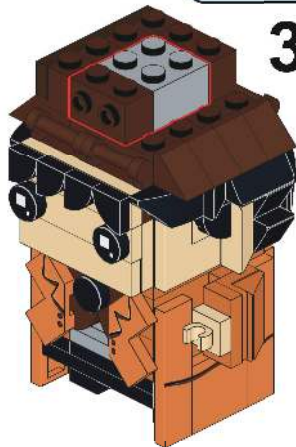

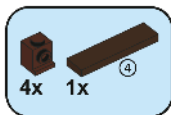

37

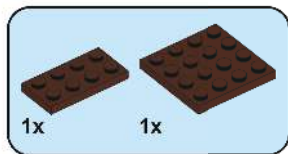
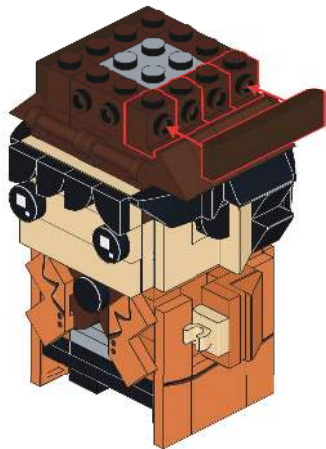

38

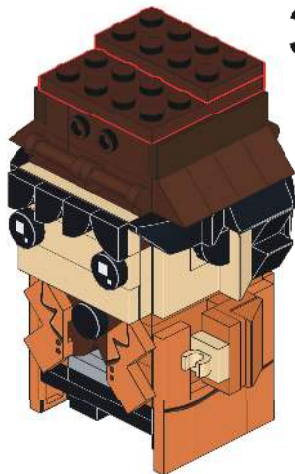



39

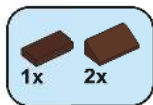
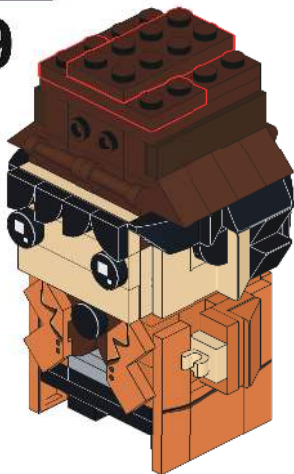

40

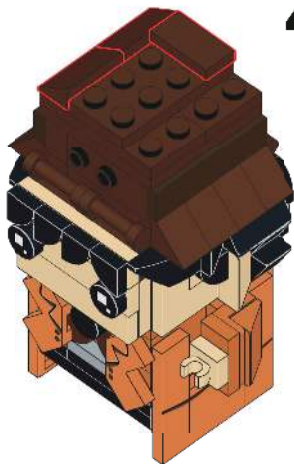



41

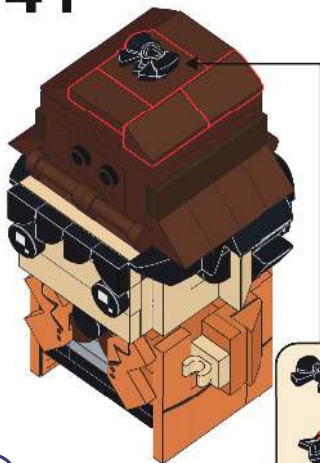

42

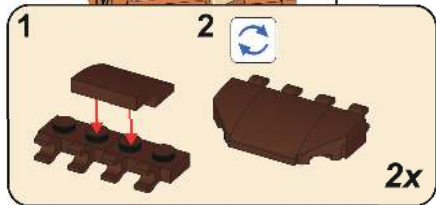
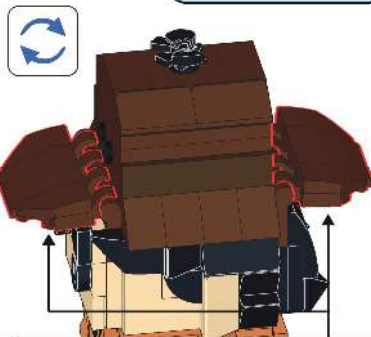

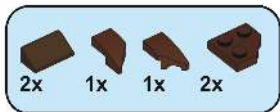

43

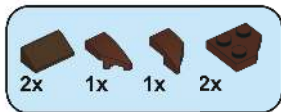
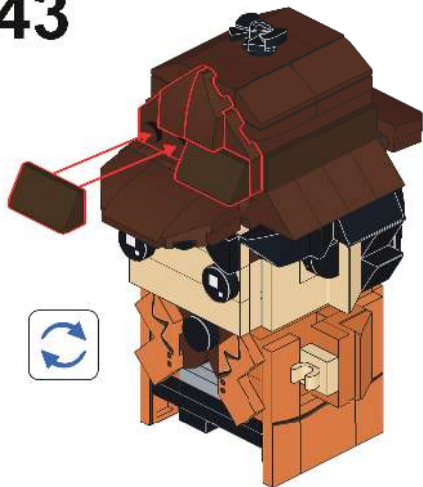

44

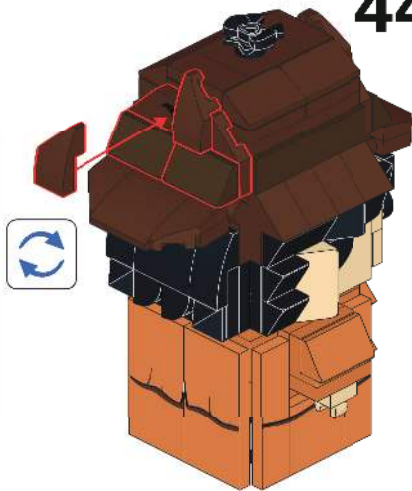

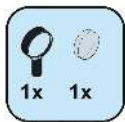

45

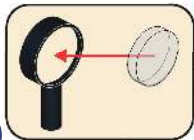

46

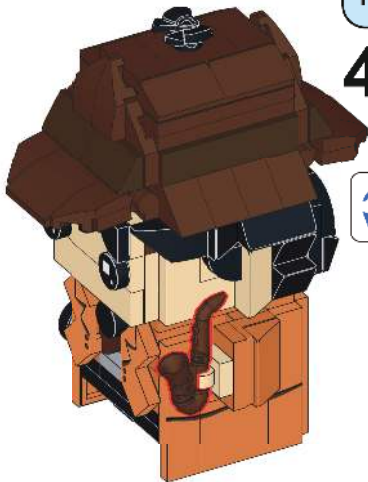

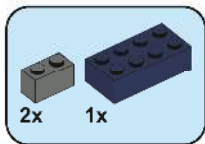
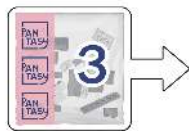

47

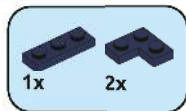
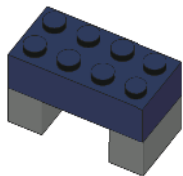

48

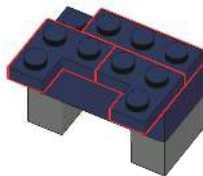

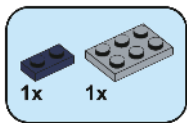

49

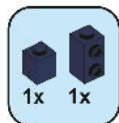
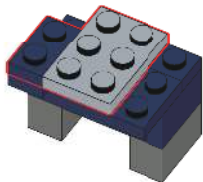

50

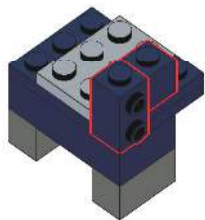

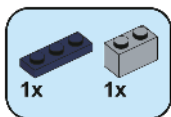

51

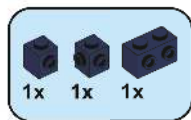
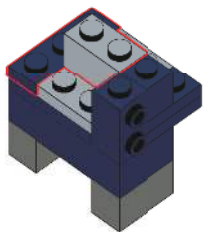

52

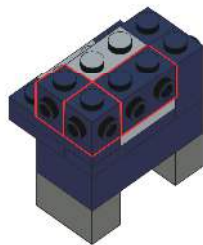

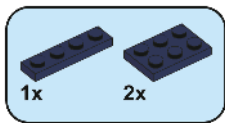

53

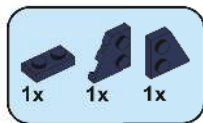
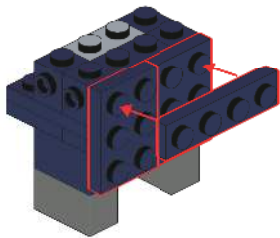

54

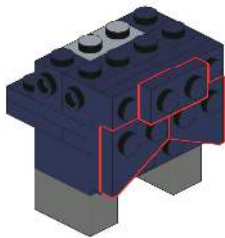

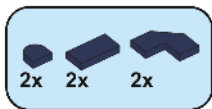

55

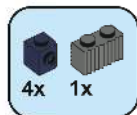
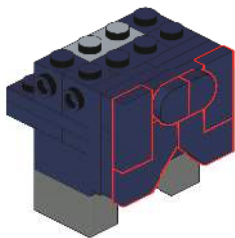

56

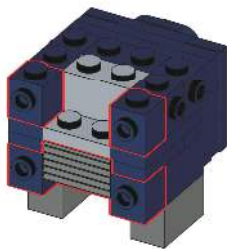

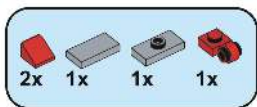

57

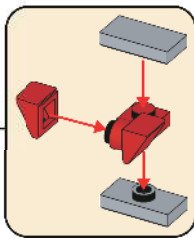
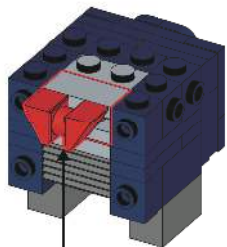

58

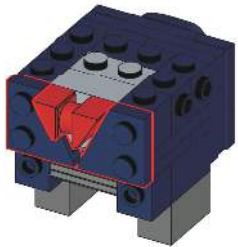

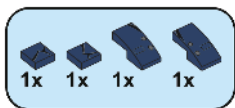

59

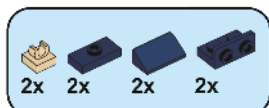
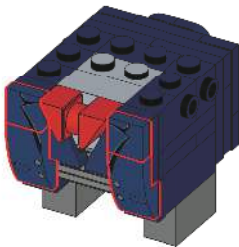

60

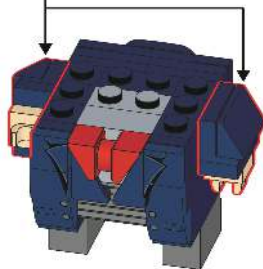
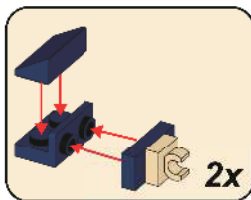

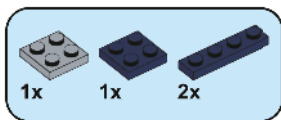

61

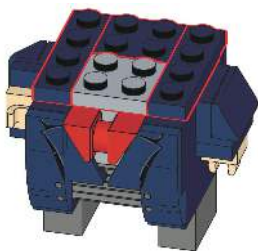

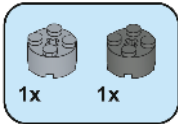

62

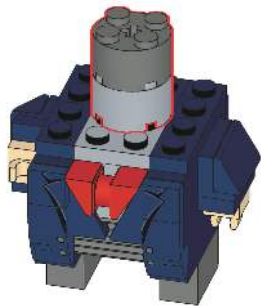

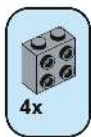

63

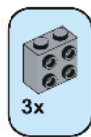
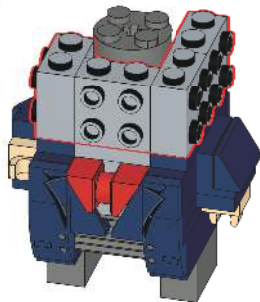

64

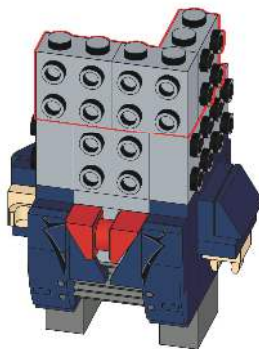

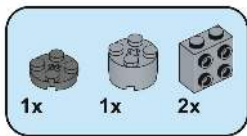

65

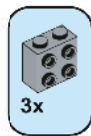
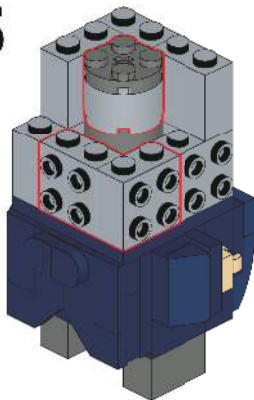

66

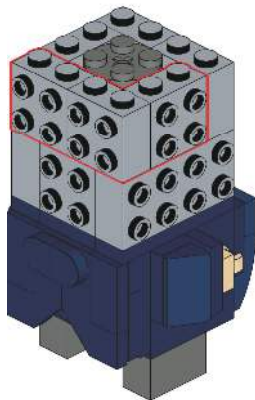

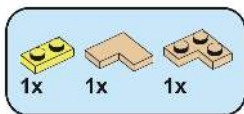

67

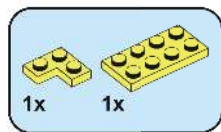
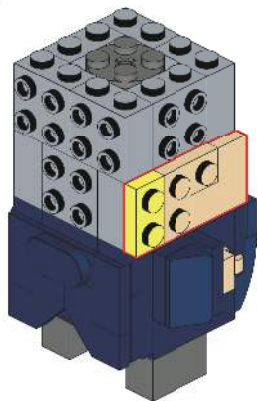

68

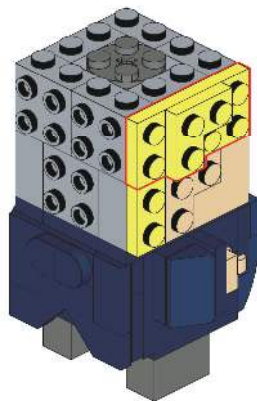

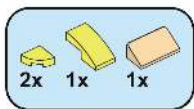

69

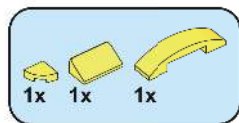
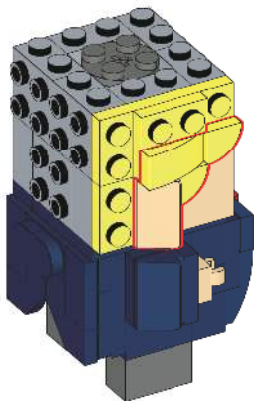

70

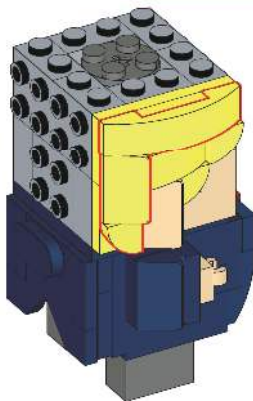

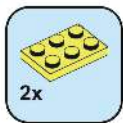

71

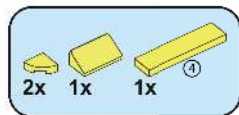
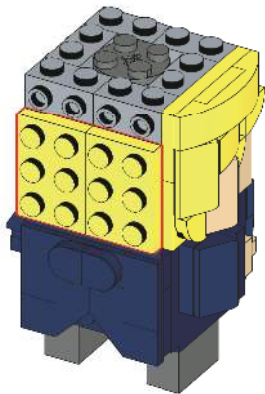

72

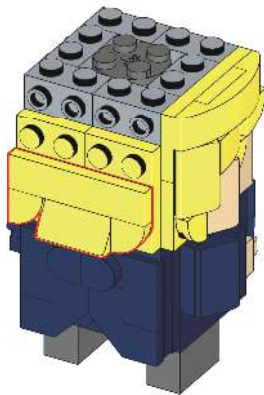



73

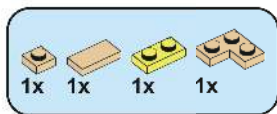
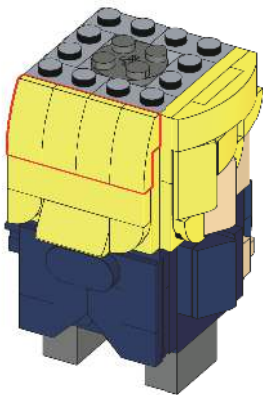

74

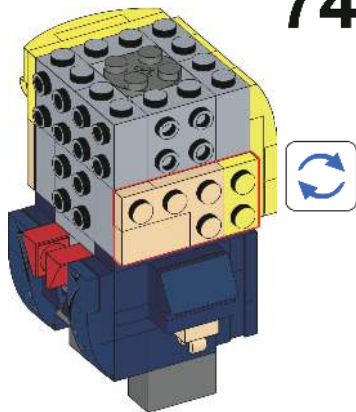

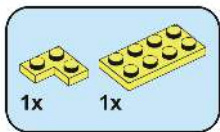

75

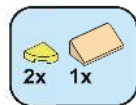
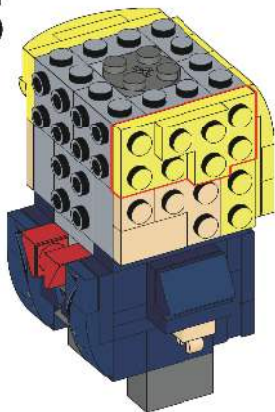

76

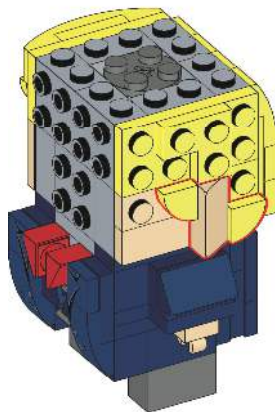

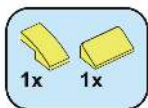

77

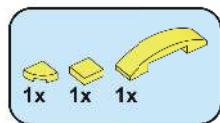
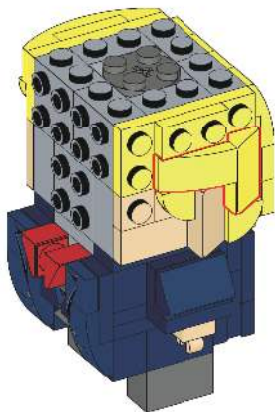

78

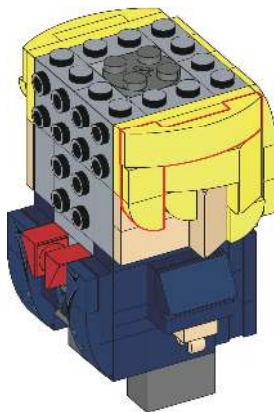

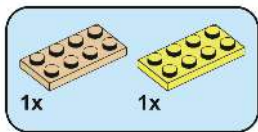

79

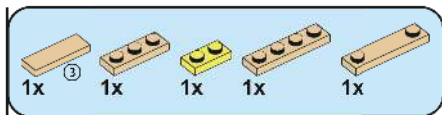
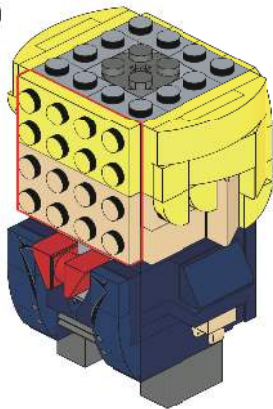

80

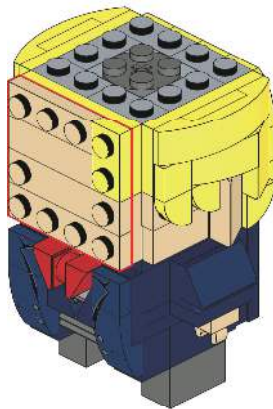



81

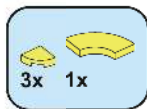
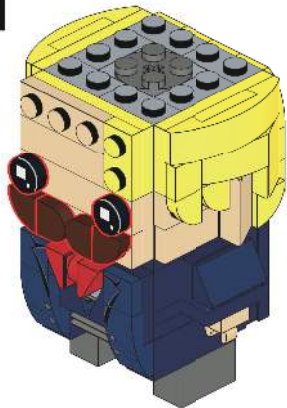

82



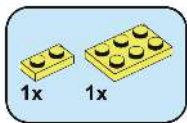

83

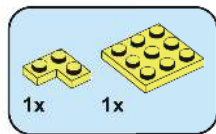
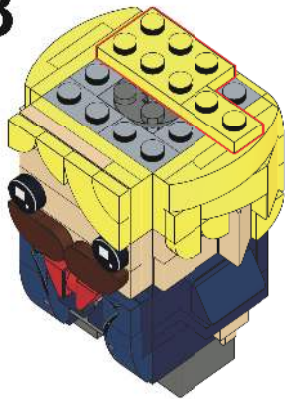

84

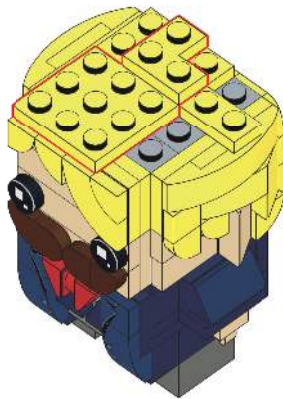

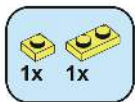

85

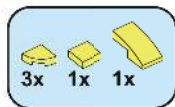
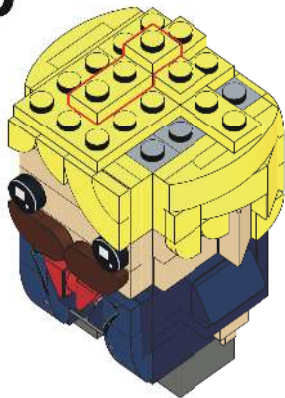

86

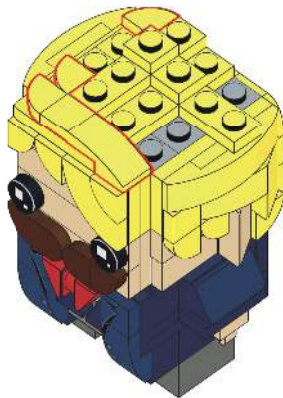

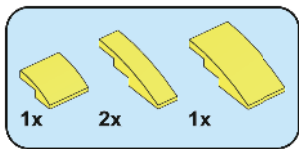

87

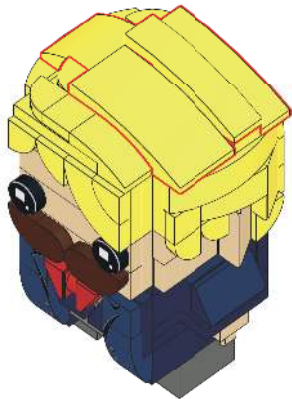

88

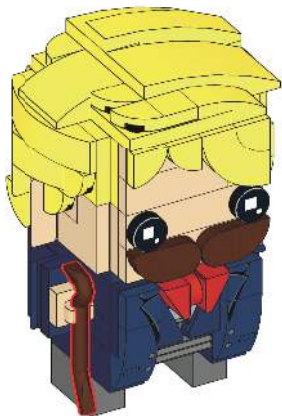

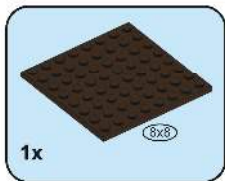
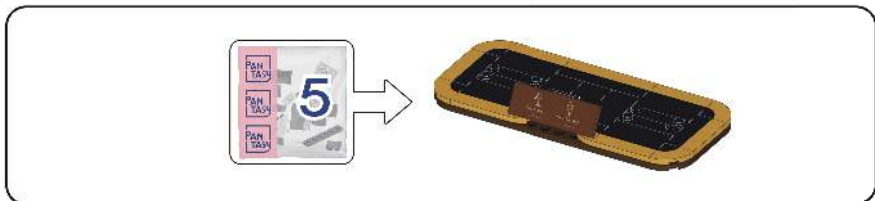

89

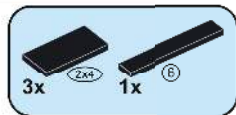
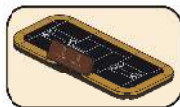

90

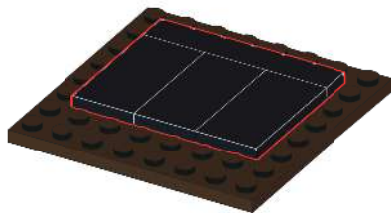

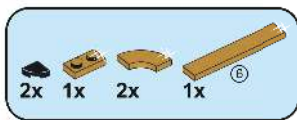

91

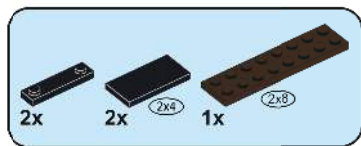
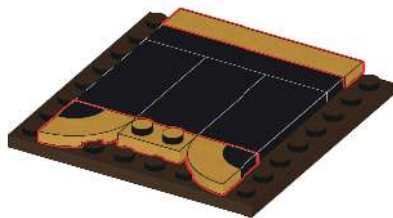

92

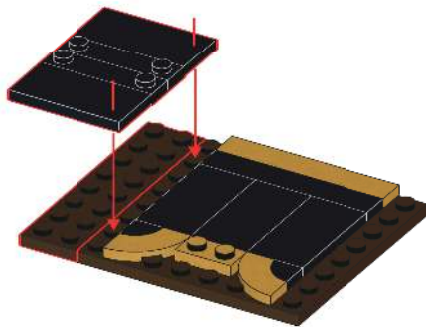

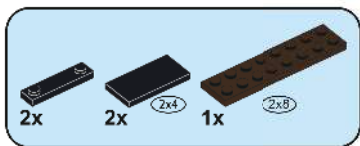

93

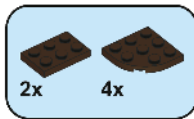
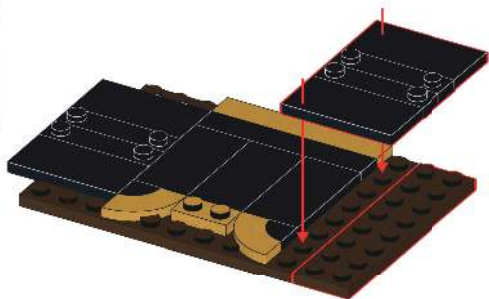

94

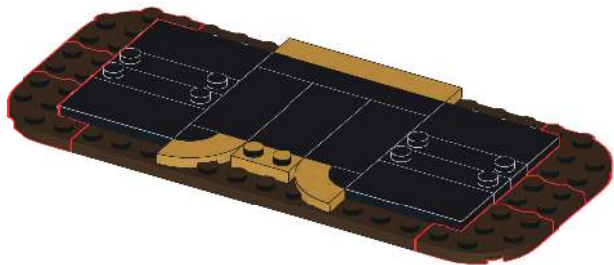

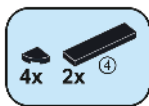

95

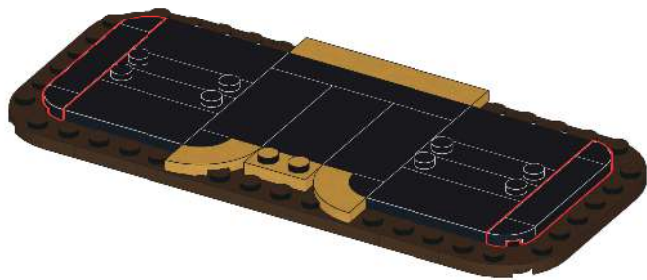

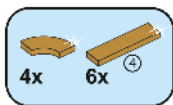

96

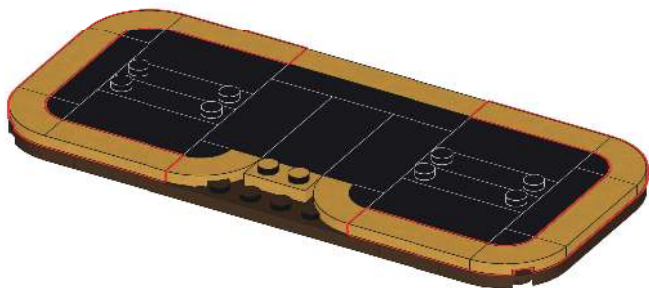

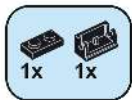

97

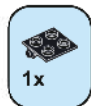

98



99



100

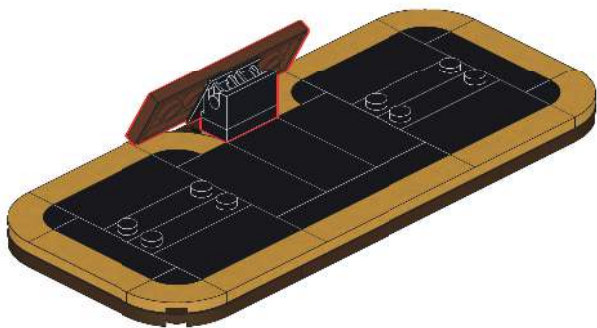

101

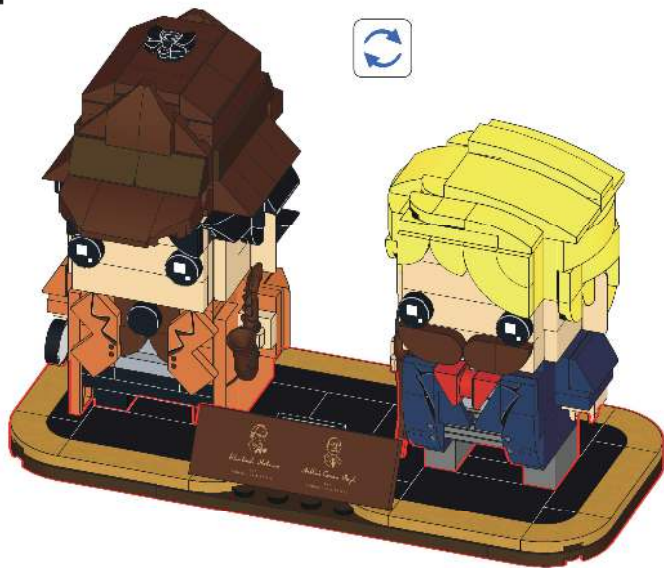

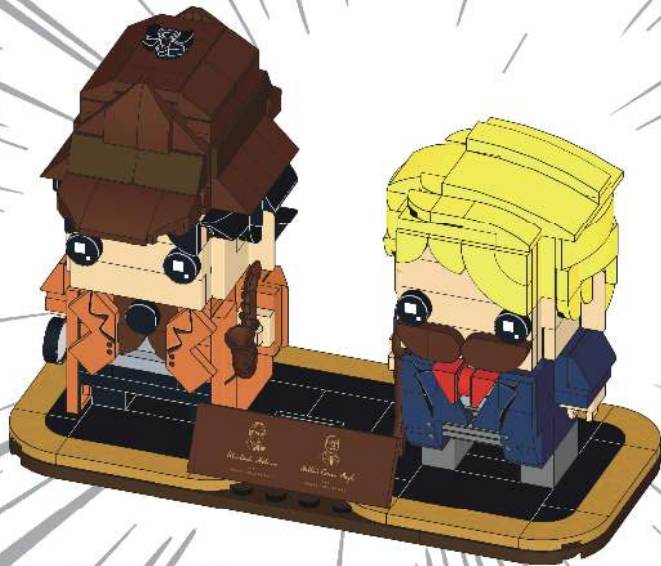



拼奇积木

86203

铁臂阿童木
透视机甲

鉄腕アトム
ASTRO BOY





拼奇积木

福尔摩斯贝克街221B

— Sherlock Holmes 221b Baker.st —

86218

221B BAKER.ST





拼奇积木

61008

复古电视机







拼奇积木



Details



Details

