



拼奇积木

99102

佟湘玉与白展堂

武林外传

My own swordsman



01 佟湘玉与白展堂

为收藏而生

呈现成年人

记忆深处的情结

打造东方审美的积木

让收藏可以更有趣



拼奇积木



▼ 每一个面世的作品，都战胜了无数个孪生兄弟



▼ 即便新人玩家，照样轻松上手

▲ 将现实抽象创作，再重塑现实本身



▼ 积累每一次突破，直到真正的颠覆



◀ 再不起眼的角落，也经历多轮打磨



扫码添加
拼奇官方福利官

- 会员计划
- 专属礼品
- 新品共创



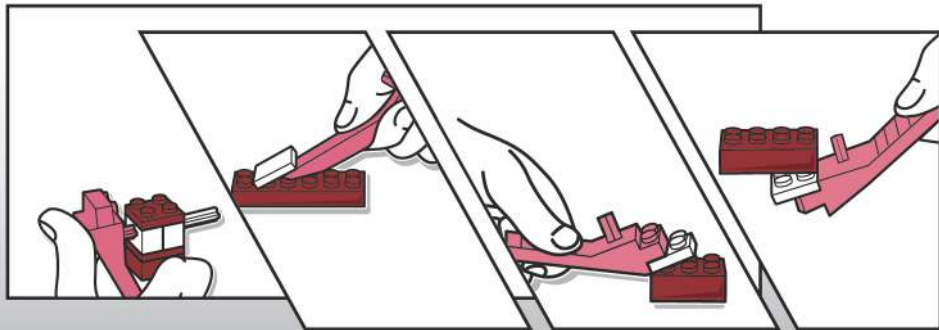
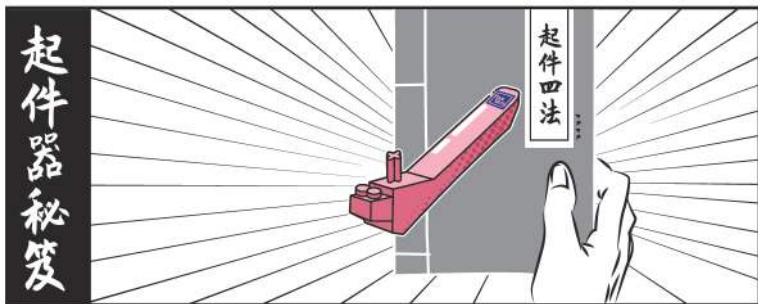

排山倒海得这么练

壹-按分包序号
依次拼搭



贰-拼搭前按颜色
或形状分类零件



叁-对应图纸
根据步骤内零件表分拣

零件走丢了



壹-扫描二维码关注官方公众号
贰-点击下方菜单栏售后客服
叁-添加客服拼奇奇申请补件

拼搭后有零件剩余

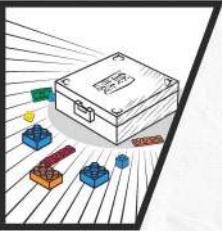

每个套装均会有少量备用零件，拼搭完成后有少量剩余零件无须担心，可储存起来日后使用哦

有困难跟湘玉讲

湘玉给你溜肥肠

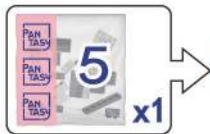

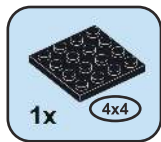
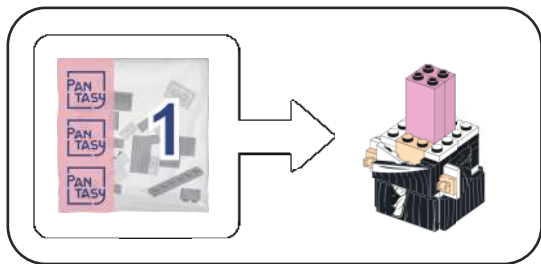

1



① 第1回



2

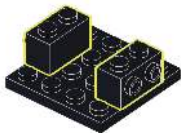

3

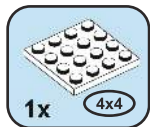
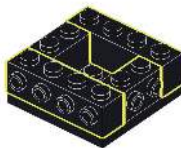

4

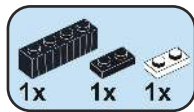

5

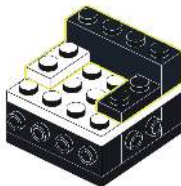

第2回

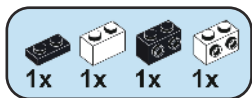

6

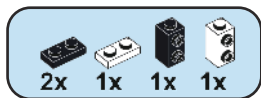
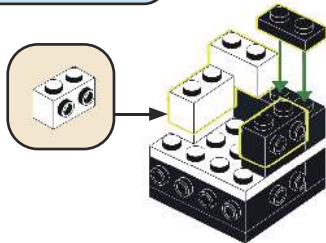

7

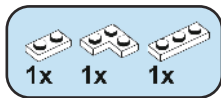
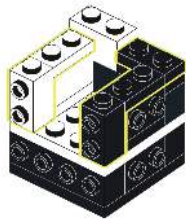

8

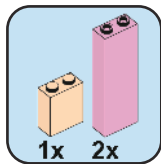

9

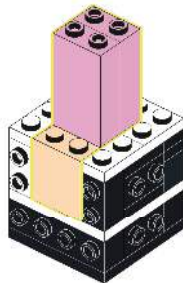

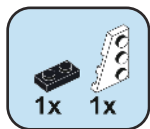

10

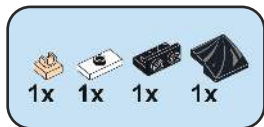
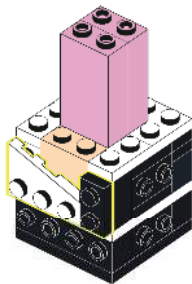

11

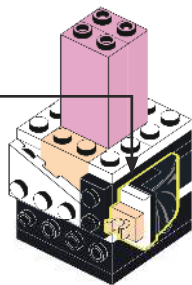
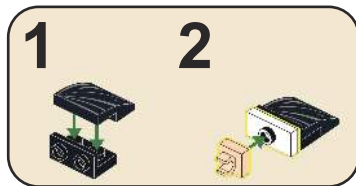

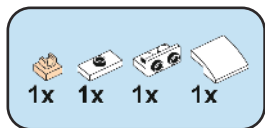

12

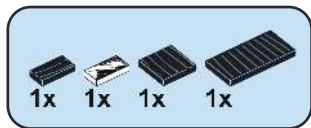
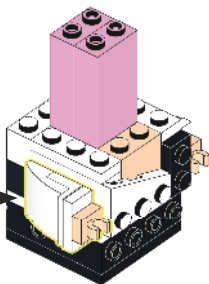
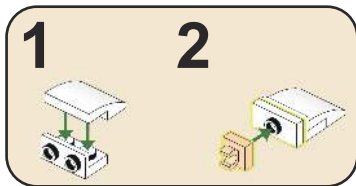

13

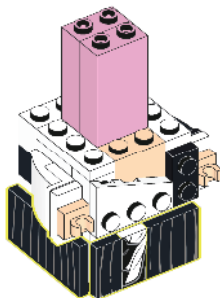



14

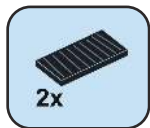
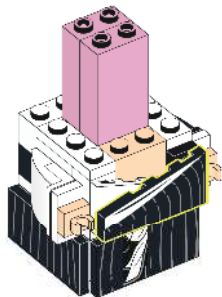

15

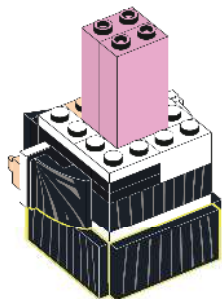

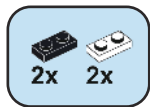

16

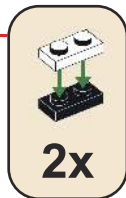
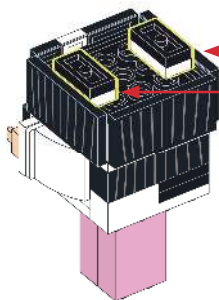

第7回

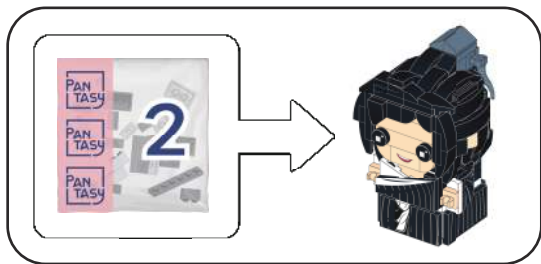

17

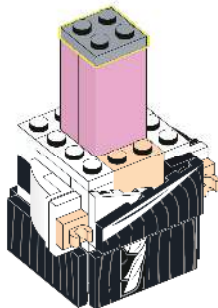

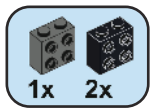

18

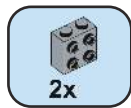
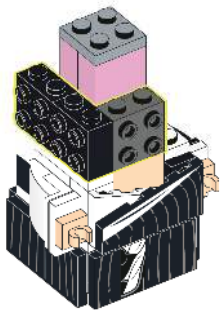

19

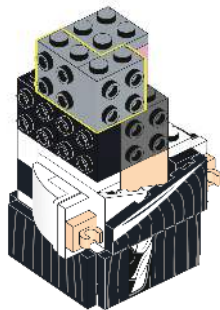

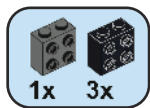

20

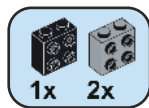
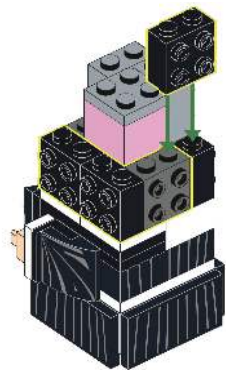

21

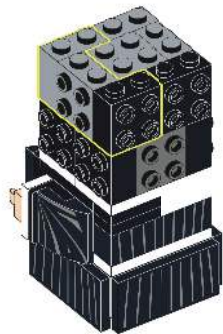

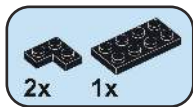

22

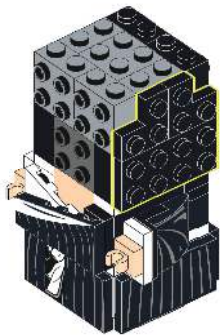

23

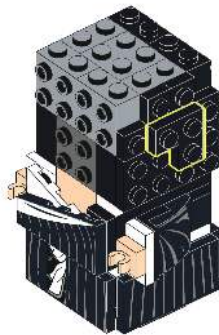



24

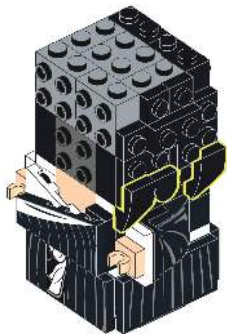

25

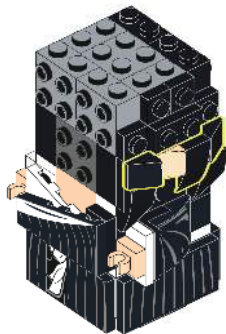



26

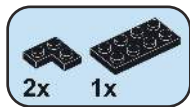
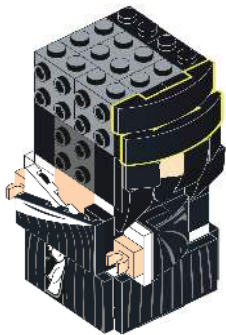

27

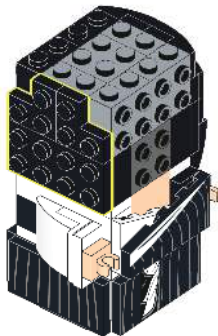



28

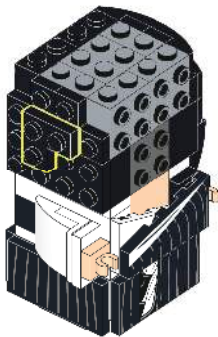

29

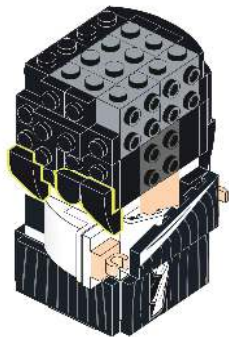

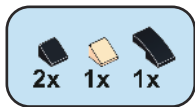

30

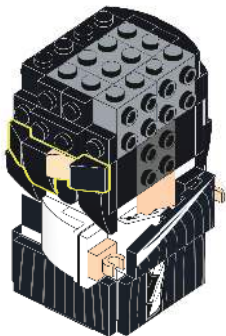

31

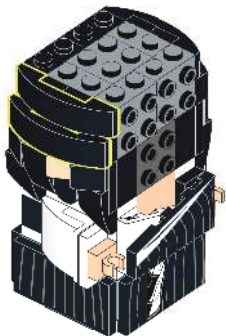

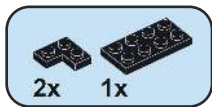

32

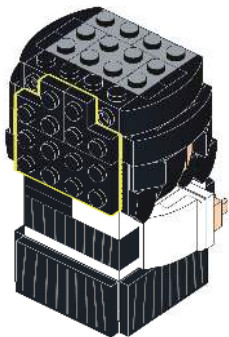

33

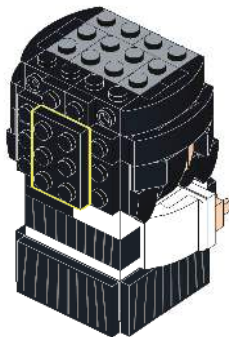



34

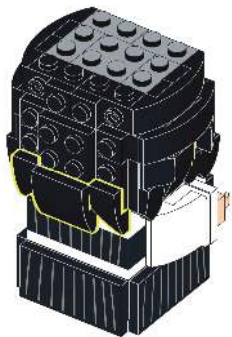

35

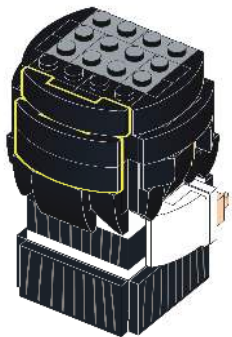

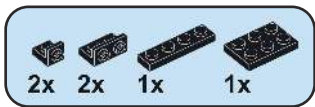

36

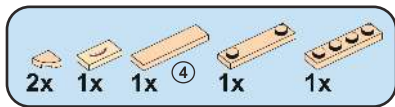
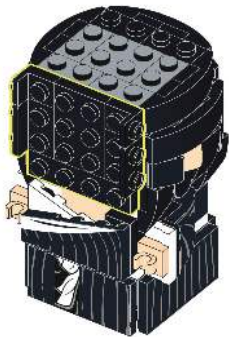

37

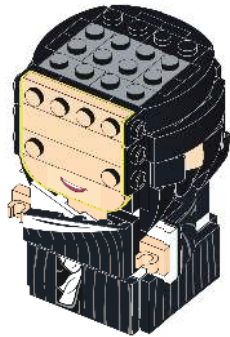



38

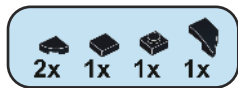
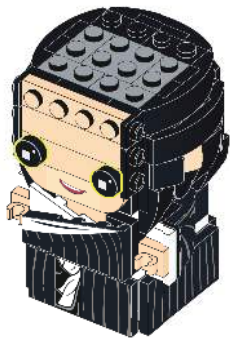

39



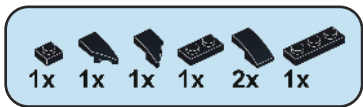

40

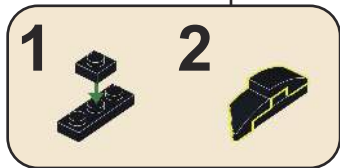
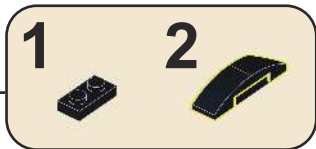

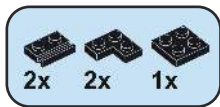

41

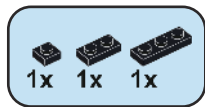
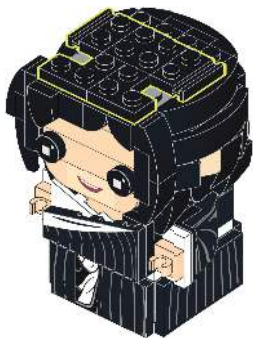

42



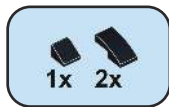

43



44



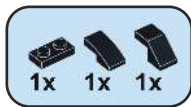

45

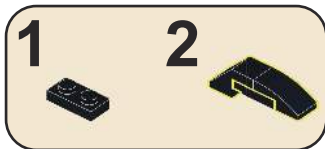

第23回



46



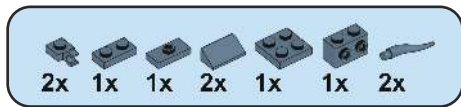

47

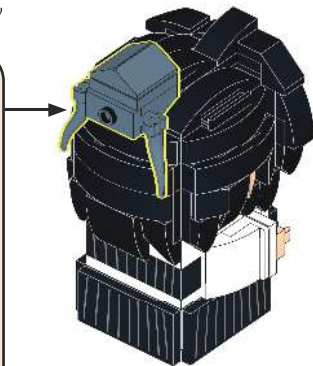
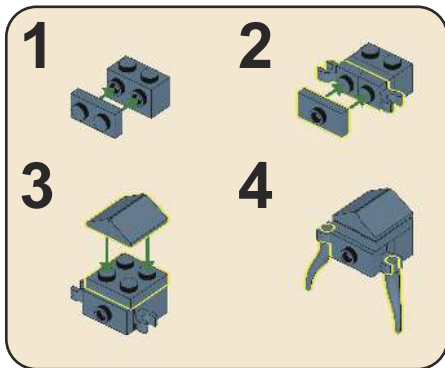

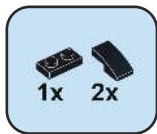

48

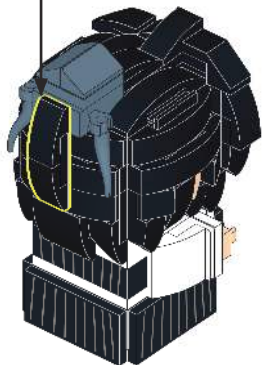
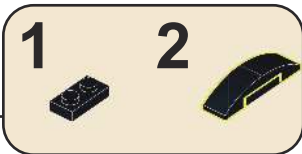

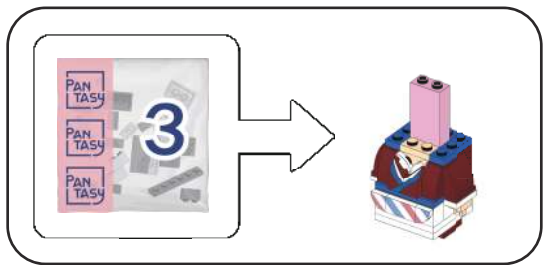

49

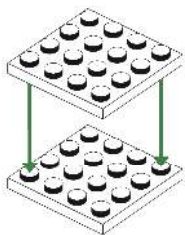

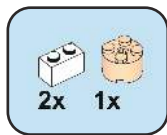

50

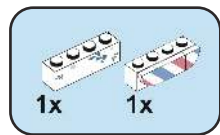
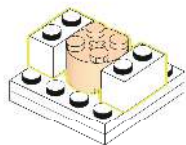

51

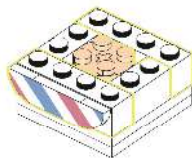

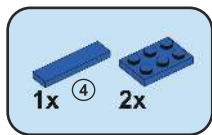

52

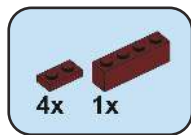
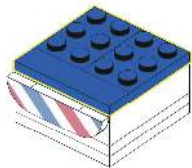

53

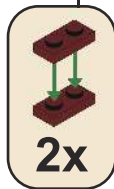
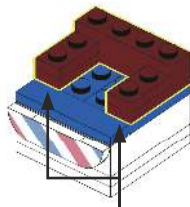

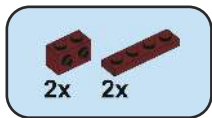

54

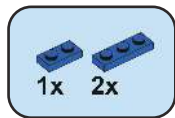
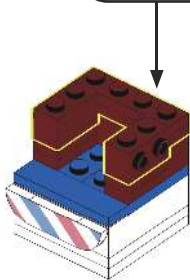
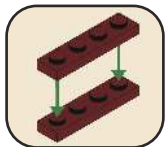

55

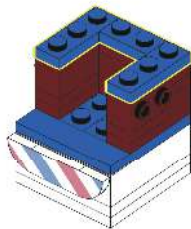

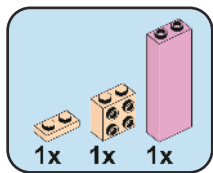

56

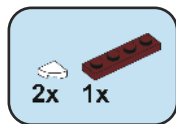
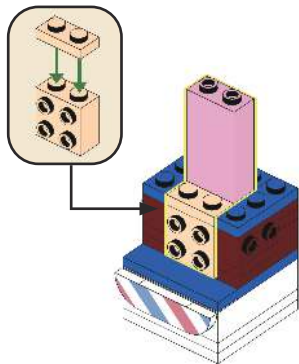

57

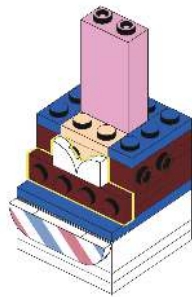



58

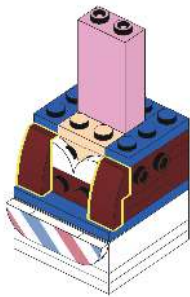

59

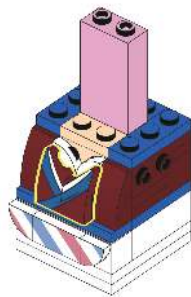

第31回

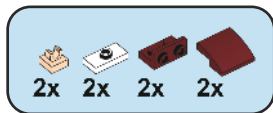

60

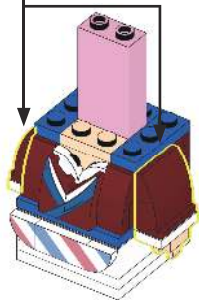
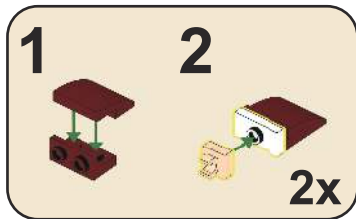

61

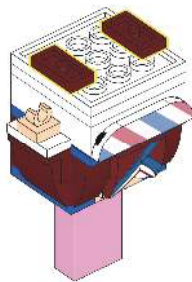

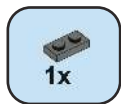
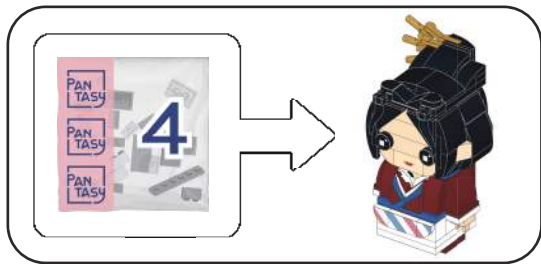

62

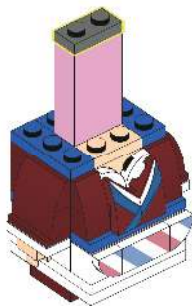

第33回

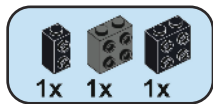

63

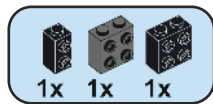
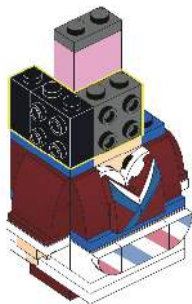

64

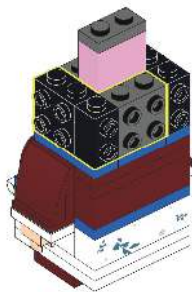

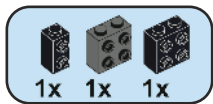

65

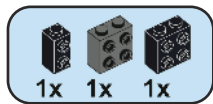
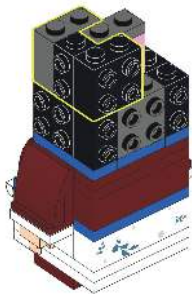

66

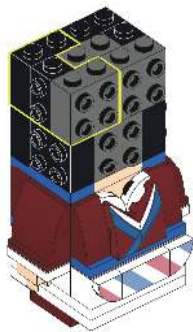



67

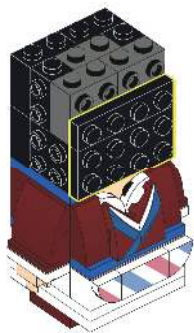

68

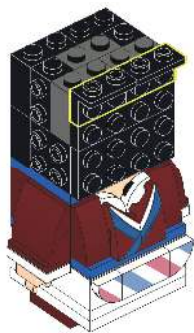

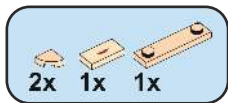

69

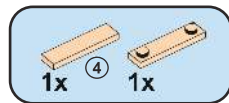
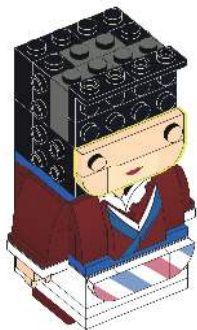

70

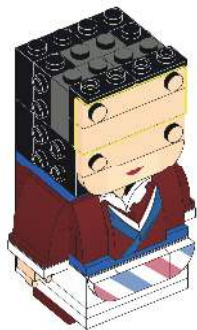



71

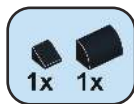

72



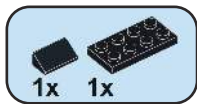

73

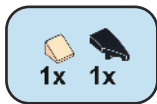

74





75

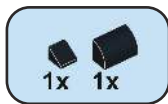

76



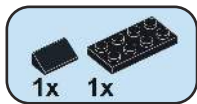

77



78



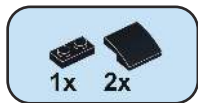

79

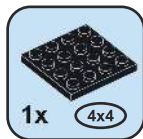

80

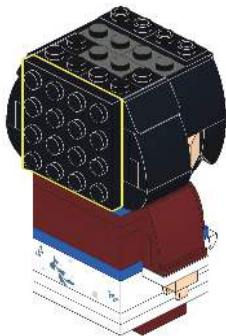

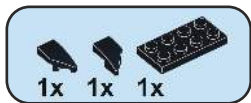

81

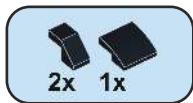
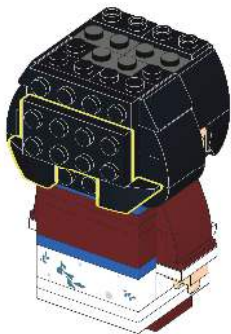

82

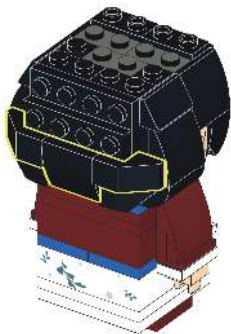

第43回



83

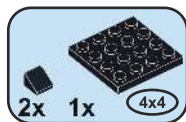
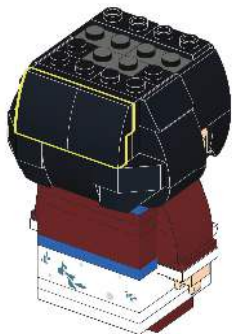

84



第44回 



85

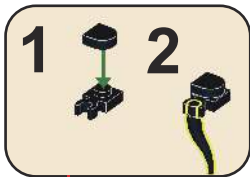

第45回

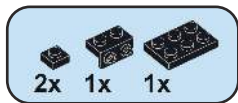

86





87



88



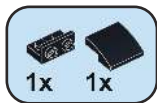

89

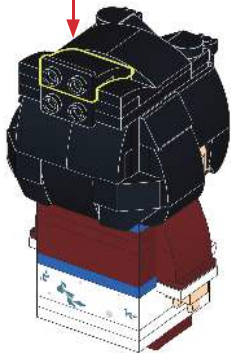

90

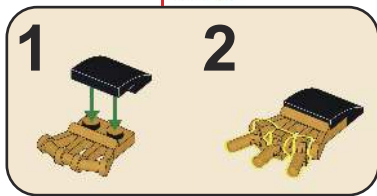
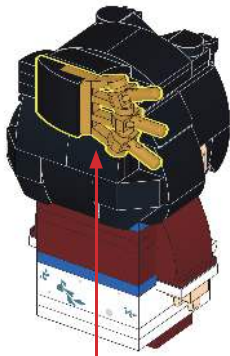

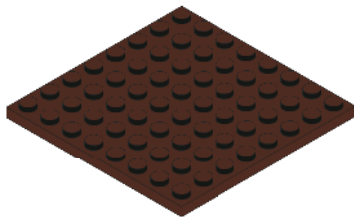
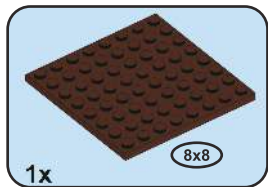
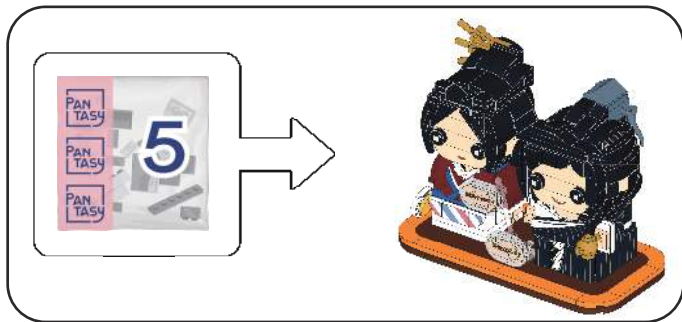

91

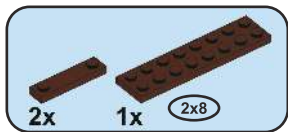

92

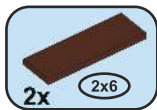
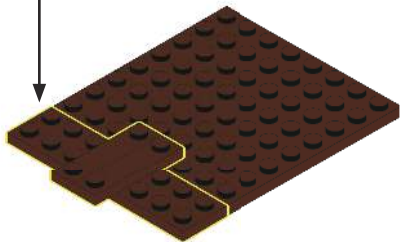
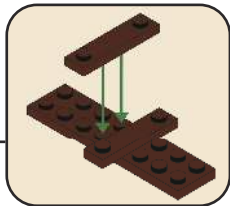

93

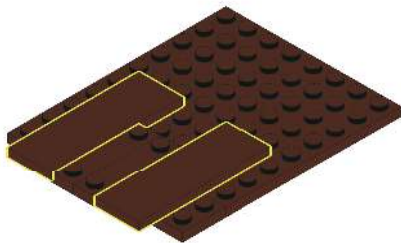

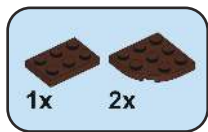

94

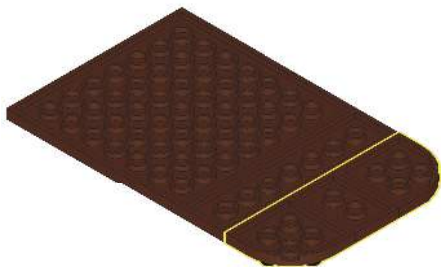

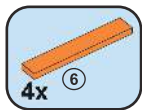

95

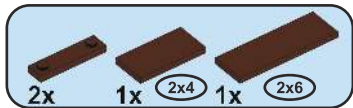
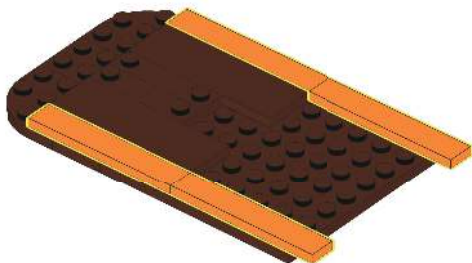

96

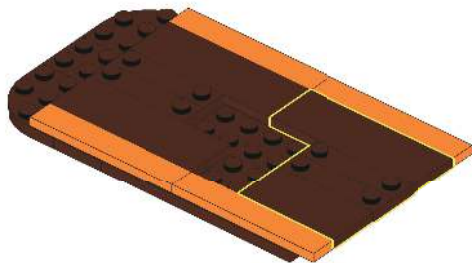

○ 第51回

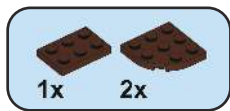

97

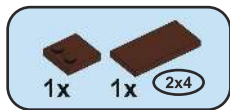

98

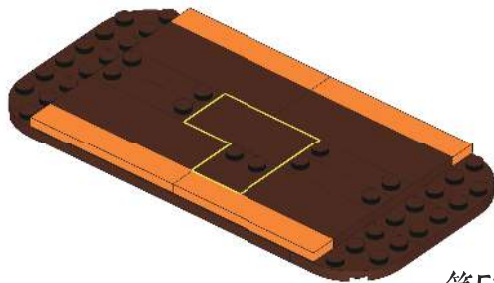



99

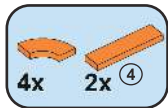
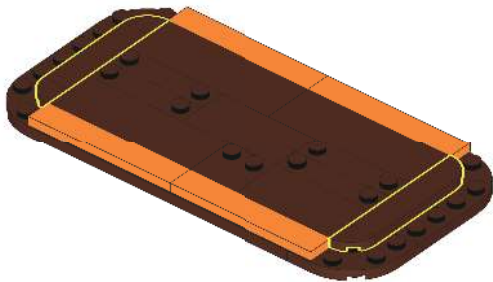

100

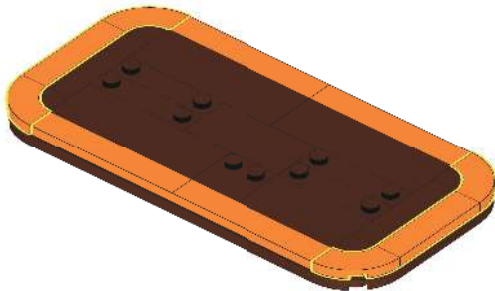

第53回

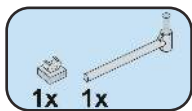

101



102



103

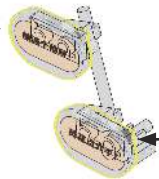
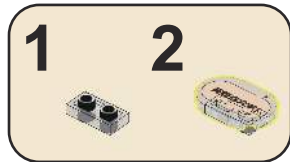
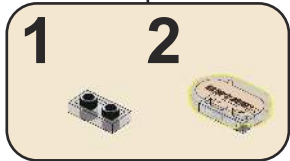

104

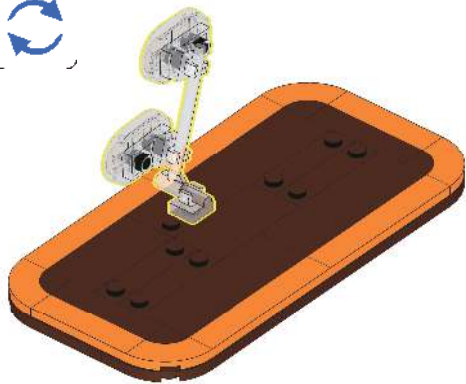
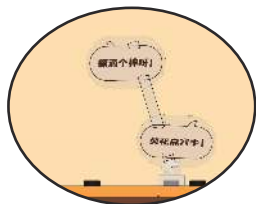

第55回



105



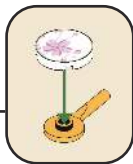
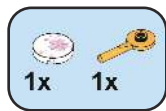

106





◎ 第57回



拼奇积木

86203

铁臂阿童木
透视机甲

鉄腕アトム
ASTRO BOY





拼奇积木

86218

221B BAKER.ST

福尔摩斯贝克街221B

— Sherlock Holmes 221b Baker.st —





拼奇积木

61008

复古电视机





拼奇积木



99103 郭芙蓉与吕轻侯



99104 莫小贝与李大夫

